

FORD **EXPLORER** Owner's Manual 2023



The information contained in this publication was correct at the time of release. In the interest of continuous development, we reserve the right to change specifications, design or equipment at any time without notice or obligation. No part of this publication may be reproduced, transmitted, stored in a retrieval system or translated into any language in any form by any means without our written permission. Errors and omissions excepted.

© Ford Motor Company 2022

All rights reserved.

Part Number: -202209-20220907112020

California Proposition 65



WARNING: Operating, servicing and maintaining a passenger vehicle or off-highway motor vehicle can expose you to chemicals including engine exhaust, carbon monoxide, phthalates, and lead, which are known to the State of California to cause cancer and birth defects or other reproductive harm. To minimize exposure, avoid breathing exhaust, do not idle the engine except as necessary, service your vehicle in a well-ventilated area and wear gloves or wash your hands frequently when servicing your vehicle. For more information go to www.P65Warnings.ca.gov/passenger-vehicle.



WARNING: Battery posts, terminals and related accessories contain lead and lead compounds, chemicals known to the State of California to cause cancer and reproductive harm.
Wash your hands after handling.

Table of Contents

Introduction

About This Manual	9
Symbols Glossary	9
Perchlorate	12
Ford Credit	12
Replacement Parts Recommendation	12
Special Notices	13
Mobile Communications Equipment	14
Export Unique Options	14

Data Privacy

Data Privacy	15
Service Data	16
Event Data	16
Settings Data	17
Connected Vehicle Data	17
Mobile Device Data	18
Emergency Call System Data	18

Environment

Protecting the Environment	19
----------------------------------	----

At a Glance

At a Glance - ST	20
Instrument Panel	21

Child Safety

General Information	23
Installing Child Restraints	25
Booster Seats	33
Child Restraint Positioning	35
Child Safety Locks	36

Seatbelts

Principle of Operation	38
Fastening the Seatbelts	39
Seatbelt Height Adjustment	41

Seatbelt Warning Lamp and Indicator Chime	41
Seatbelt Reminder	42
Child Restraint and Seatbelt Maintenance	43
Seatbelt Extensions	44

Personal Safety System™

Personal Safety System™	45
-------------------------------	----

Supplementary Restraints System

Principle of Operation	46
Driver and Passenger Airbags	47
Front Passenger Sensing System	48
Side Airbags	50
Driver and Passenger Knee Airbags	51
Safety Canopy™	51
Crash Sensors and Airbag Indicator	52
Airbag Disposal	53

Pedestrian Protection - Hybrid Electric Vehicle (HEV)

Pedestrian Alert System	54
-------------------------------	----

911 Assist

What Is 911 Assist	55
How Does 911 Assist Work	55
Emergency Call Requirements	55
Emergency Call Limitations	56

Keys and Remote Controls

General Information on Radio Frequencies	57
Remote Control	57
Replacing a Lost Key or Remote Control	63

MyKey™

Principle of Operation	64
------------------------------	----

Table of Contents

Creating a MyKey	65
Clearing All MyKeys	66
Checking MyKey System Status	66
Using MyKey With Remote Start Systems	67
MyKey – Troubleshooting	67

Doors and Locks

Locking and Unlocking	68
Keyless Entry	71

Liftgate

Power Liftgate	73
----------------------	----

Security

Passive Anti-Theft System	77
Anti-Theft Alarm	77

Steering Wheel

Adjusting the Steering Wheel - Vehicles With: Manual Adjustable Steering Column	79
Adjusting the Steering Wheel - Vehicles With: Power Adjustable Steering Column	79
Audio Control	81
Voice Control	81
Cruise Control - Vehicles With: Cruise Control	81
Cruise Control - Vehicles With: Stop and Go	82
Information Display Control	82
Heated Steering Wheel	82
Horn	82

Wipers and Washers

Windshield Wipers	83
Autowipers	83
Windshield Washers	84
Rear Window Wiper and Washers	85

Lighting

General Information	86
Lighting Control	86
Autolamps	87
Instrument Lighting Dimmer	87
Headlamp Exit Delay	87
Daytime Running Lamps - Vehicles With: Configurable Daytime Running Lamps	88
Daytime Running Lamps - Vehicles With: Daytime Running Lamps (DRL)	88
Front Fog Lamps	88
Adaptive Headlamps	89
Direction Indicators	89
Interior Lamps	90
Ambient Lighting - Vehicles With: 8 Inch Center Display Screen	90
Ambient Lighting - Vehicles With: 10.1 Inch Center Display Screen	91

Automatic High Beam Control

What Is Automatic High Beam Control	92
Switching Automatic High Beam Control On and Off	92
Automatic High Beam Control Indicators	93
Overriding Automatic High Beam Control	93

Windows and Mirrors

Power Windows	94
Global Opening	95
Exterior Mirrors - Excluding: ST	95
Exterior Mirrors - ST	96
Interior Mirror	98
Sun Visors	98
Sun Shades	99
Moonroof	99

Table of Contents

Instrument Cluster

Gauges - Vehicles With: 6.5 Inch Instrument Cluster Display Screen	101
Gauges - Vehicles With: 12.3 Inch Instrument Cluster Display Screen	102
Gauges - Vehicles With: 4.2 Inch Instrument Cluster Display Screen	104
Warning Lamps and Indicators	105
Audible Warnings and Indicators	109

Information Displays

General Information - Vehicles With: 6.5 Inch Instrument Cluster Display Screen	110
General Information - Vehicles With: 12.3 Inch Instrument Cluster Display Screen	112
General Information - Vehicles With: 4.2 Inch Instrument Cluster Display Screen	115
Personalized Settings	117
Information Messages	119

Climate Control

Automatic Climate Control	137
Hints on Controlling the Interior Climate	139
Rear Passenger Climate Controls	140
Heated Windshield	141
Heated Rear Window	142
Heated Exterior Mirrors	142
Remote Start	142

Interior Air Quality

What Is the Cabin Air Filter	143
Replacing the Cabin Air Filter	143

Seats

Sitting in the Correct Position	144
---------------------------------------	-----

Head Restraints	144
Manual Seats	146
Power Seats	147
Memory Function	150
Rear Seats	151
Heated Seats	156
Ventilated Seats	157

Rear Occupant Alert System

What is the Rear Occupant Alert System	158
How Does the Rear Occupant Alert System Work	158
Rear Occupant Alert System Precautions	158
Rear Occupant Alert System Limitations	158
Switching Rear Occupant Alert System On and Off	158
Rear Occupant Alert System Indicators	159
Rear Occupant Alert System Audible Warnings	159

Garage Door Opener

What Is the Garage Door Opener	160
How Does the Garage Door Opener Work	160
Garage Door Opener Precautions	160
Garage Door Opener Limitations	160
Programming the Garage Door Opener to Your Hand-Held Transmitter	161
Programming the Garage Door Opener to Your Garage Door Opener Motor	161
Programming the Garage Door Opener to Your Gate Opener Motor	162
Clearing the Garage Door Opener	162
Reprogramming the Garage Door Opener	163
Garage Door Opener Radio Frequencies	163

Table of Contents

Auxiliary Power Points

Auxiliary Power Points164

Wireless Accessory Charger

What Is the Wireless Accessory Charger166

Wireless Accessory Charger Precautions166

Locating the Wireless Accessory Charger166

Charging a Wireless Device166

Storage Compartments

Cup Holders167

Overhead Console167

Starting and Stopping the Engine

General Information168

Ignition Switch168

Keyless Starting169

Starting a Gasoline Engine169

Starting a Hybrid Electric Vehicle System172

Engine Block Heater174

Unique Driving Characteristics

Auto-Start-Stop176

Hybrid Vehicle Operation - Hybrid Electric Vehicle (HEV)178

Hybrid Vehicle Frequently Asked Questions - Hybrid Electric Vehicle (HEV)180

Fuel and Refueling

Safety Precautions181

Fuel Quality - E85181

Fuel Quality - Gasoline183

Fuel Filler Funnel Location183

Running Out of Fuel183

Refueling - Excluding: Hybrid Electric Vehicle (HEV)185

Refueling - Hybrid Electric Vehicle (HEV)188

Fuel Consumption191

Engine Emission Control

Emission Law192

Catalytic Converter193

High Voltage Battery

General Information - Hybrid Electric Vehicle (HEV)196

Transmission

Automatic Transmission197

Four-Wheel Drive

Principle of Operation203

Using Four-Wheel Drive203

Rear Axle

Limited Slip Differential209

Brakes

General Information210

Hints on Driving With Anti-Lock Brakes211

Electric Parking Brake211

Hill Start Assist213

Auto Hold214

Reverse Braking Assist

What Is Reverse Braking Assist216

Reverse Braking Assist Precautions216

Switching Reverse Braking Assist On and Off217

Overriding Reverse Braking Assist217

Reverse Braking Assist Indicators217

Reverse Braking Assist - Troubleshooting218

Table of Contents

Traction Control

Principle of Operation	220
Using Traction Control	220

Stability Control

Principle of Operation	221
Using Stability Control	222

Hill Descent Control

What Is Hill Descent Control	224
Switching Hill Descent Control On and Off	224
Setting the Hill Descent Speed	224
Hill Descent Control Indicator	224

Parking Aids

Principle of Operation	225
Rear Parking Aid	225
Front Parking Aid	227
Side Sensing System	229
Active Park Assist	230
Rear View Camera	234
360 Degree Camera	237

Cruise Control

What Is Cruise Control	239
Switching Cruise Control On and Off	239
Setting the Cruise Control Speed	239
Canceling the Set Speed	240
Resuming the Set Speed	240
Cruise Control Indicators	240

Adaptive Cruise Control

How Does Adaptive Cruise Control With Stop and Go Work	241
What Is Adaptive Cruise Control With Lane Centering	241
What Is Intelligent Adaptive Cruise Control	241

Adaptive Cruise Control Precautions - Vehicles With: Lane Centering	241
Adaptive Cruise Control Precautions - Vehicles With: Stop and Go	241
Adaptive Cruise Control Limitations - Vehicles With: Lane Centering	242
Adaptive Cruise Control Limitations - Vehicles With: Stop and Go	243
Switching Adaptive Cruise Control On and Off	245
Setting the Adaptive Cruise Control Speed	245
Setting the Adaptive Cruise Control Gap	246
Canceling the Set Speed	247
Resuming the Set Speed	247
Overriding the Set Speed	247
Adaptive Cruise Control Indicators - Vehicles With: Intelligent Adaptive Cruise Control	248
Adaptive Cruise Control Indicators - Vehicles With: Lane Centering	248
Adaptive Cruise Control Indicators - Vehicles With: Stop and Go	248
Switching From Adaptive Cruise Control to Cruise Control	248
Switching Lane Centering On and Off	249
Switching Intelligent Mode On and Off	250
Adjusting the Set Speed Tolerance	250
Adaptive Cruise Control - Troubleshooting	250

Driving Aids

Driver Alert	254
Lane Keeping System	255
Blind Spot Information System	259
Cross Traffic Alert	263
Speed Sign Recognition	266
Steering	268
Pre-Collision Assist	268

Table of Contents

Drive Mode Control

What Is Drive Mode Control	273
How Does Drive Mode Control Work	273
Selecting a Drive Mode	273
Drive Modes	273

Load Carrying

General Information	275
Rear Under Floor Storage	275
Cargo Nets	276
Roof Racks and Load Carriers	276
Load Limit	277

Towing

Towing a Trailer	283
Trailer Sway Control	284
Recommended Towing Weights	284
Essential Towing Checks	285
Towing the Vehicle on Four Wheels	287

Driving Hints

Reduced Engine Performance	288
Cold Weather Precautions	288
Breaking-In	288
Driving Economically	288
Driving Through Shallow Water	289
Floor Mats	289

Roadside Emergencies

Roadside Assistance	291
Hazard Flashers	292
Fuel Shutoff	292
Jump Starting the Vehicle	293
Collision, Damage or Fire Event	295
Post-Crash Alert System	296
Transporting the Vehicle	296

Customer Assistance

Getting the Services You Need	298
In California (U.S. Only)	299
The Better Business Bureau (BBB) Auto Line Program (U.S. Only)	300
Utilizing the Mediation/Arbitration Program (Canada Only)	301
Getting Assistance Outside the U.S. and Canada	301
Ordering Additional Owner's Literature	303
Reporting Safety Defects (U.S. Only)	303
Reporting Safety Defects (Canada Only)	303

Fuses

Fuse Specification Chart	305
Changing a Fuse	313

Maintenance

General Information	315
Opening and Closing the Hood	315
Under Hood Overview - 2.3L EcoBoost™	316
Under Hood Overview - 3.0L	317
Under Hood Overview - 3.3L	318
Engine Oil Dipstick - 2.3L EcoBoost™	319
Engine Oil Dipstick - 3.0L	319
Engine Oil Dipstick - 3.3L	319
Engine Oil Check	319
Oil Change Indicator Reset	320
Changing the Engine Air Filter - 2.3L EcoBoost™	321
Changing the Engine Air Filter - 3.0L	322
Changing the Engine Air Filter - 3.3L	323
Engine Coolant Check	324
Automatic Transmission Fluid Check	328
Brake Fluid Check	328

Table of Contents

Power Steering Fluid Check	329
Changing the 12V Battery - Excluding: Hybrid Electric Vehicle (HEV)	329
Changing the 12V Battery - Hybrid Electric Vehicle (HEV)	332
Adjusting the Headlamps	335
Washer Fluid Check	336
Fuel Filter	336
Checking the Wiper Blades	336
Changing the Front Wiper Blades	336
Changing the Rear Wiper Blades	337
Changing a Bulb	337

Vehicle Care

General Information	339
Cleaning Products	339
Cleaning the Exterior	340
Waxing	341
Cleaning the Engine	341
Cleaning the Windows and Wiper Blades	342
Cleaning the Interior	342
Cleaning the Instrument Panel and Instrument Cluster Lens	343
Cleaning Leather Seats	343
Repairing Minor Paint Damage	344
Cleaning the Wheels	344
Vehicle Storage	344
Body Styling Kits	346

Wheels and Tires

General Information	347
Tire Care	349
Using Summer Tires	362
Using Winter Tires	362
Using Snow Chains	363
Tire Pressure Monitoring System	364
Changing a Road Wheel	370
Technical Specifications	376

Capacities and Specifications

Engine Specifications - 2.3L EcoBoost™	378
Engine Specifications - 3.0L, ST	378
Engine Specifications - 3.0L	380
Engine Specifications - 3.3L, Gasoline	380
Engine Specifications - 3.3L, Hybrid Electric Vehicle (HEV)	381
Motorcraft Parts - 2.3L EcoBoost™	382
Motorcraft Parts - 3.0L	382
Motorcraft Parts - 3.3L	383
Vehicle Identification Number	383
Capacities and Specifications - 2.3L EcoBoost™	384
Capacities and Specifications - 3.0L	391
Capacities and Specifications - 3.3L, Gasoline	398
Capacities and Specifications - 3.3L, Hybrid Electric Vehicle (HEV)	405
Bulb Specification Chart	412

Connected Vehicle

What Is a Connected Vehicle	414
Connected Vehicle Requirements	414
Connected Vehicle Limitations	414
Connecting the Vehicle to a Mobile Network	414
Connecting the Vehicle to a Wi-Fi Network - Vehicles With: SYNC 3	414
Connected Vehicle – Troubleshooting - Vehicles With: Modem	415
Connected Vehicle – Troubleshooting - Vehicles With: SYNC 3	416

Vehicle Wi-Fi Hotspot

Creating a Vehicle Wi-Fi Hotspot	418
Changing the Vehicle Wi-Fi Hotspot Name or Password	418

Table of Contents

Audio System

General Information	419
Audio Unit	419
Digital Radio	420
Satellite Radio	422
USB Port	425

SYNC™ 3

General Information	427
Using Voice Recognition	429
Entertainment	435
Climate	445
Phone	447
Navigation	449
Electric Vehicle Information	454
Apps	455
Settings	458
SYNC™ 3 Troubleshooting	460

Accessories

Accessories	473
-------------------	-----

Ford Protect

Ford Protect	474
--------------------	-----

Scheduled Maintenance

General Maintenance Information	476
Normal Scheduled Maintenance	479
Special Operating Conditions Scheduled Maintenance	482

Customer Information

Rollover Warning	485
Radio Frequency Certification Labels	485
Warranty Information	529

Appendices

Electromagnetic Compatibility	531
End User License Agreement	534

Introduction

ABOUT THIS MANUAL

Thank you for choosing Ford. We recommend that you take some time to get to know your vehicle by reading this manual. The more that you know about your vehicle, the greater the safety and pleasure you will get from driving it.



WARNING: Driving while distracted can result in loss of vehicle control, crash and injury. We strongly recommend that you use extreme caution when using any device that may take your focus off the road. Your primary responsibility is the safe operation of your vehicle. We recommend against the use of any hand-held device while driving and encourage the use of voice-operated systems when possible. Make sure you are aware of all applicable local laws that may affect the use of electronic devices while driving.

Note: This manual describes product features and options available throughout the range of available models, sometimes even before they are generally available. It may describe options not fitted to the vehicle you have purchased.

Note: Some of the illustrations in this manual may show features as used in different models, so may appear different to you on your vehicle.

Note: Always use and operate your vehicle in line with all applicable laws and regulations.

Note: Pass on this manual when selling your vehicle. It is an integral part of your vehicle.

This manual may qualify the location of a component as left-hand side or right-hand side. The side is determined when facing forward in the seat.

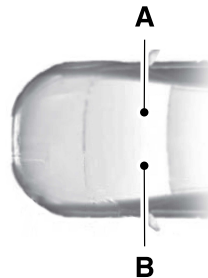

- A Right-hand side.
- B Left-hand side.

SYMBOLS GLOSSARY

These are some of the symbols you may see on your vehicle.



Airbag



Air conditioning system



Air conditioning system lubricant type



Anti-lock braking system



Avoid smoking, flames or sparks



Battery



Battery acid



Blower motor

Introduction



Brake fluid - non petroleum based



Brake system



Brake system



Cabin air filter



Check fuel cap



Child safety door lock or unlock



Child seat lower anchor



Child seat tether anchor



Cruise control



Do not open when hot



Electric Parking brake



Engine air filter



Engine coolant



Engine coolant temperature



Engine oil



Explosive gas



Fan warning



Fasten seatbelt



Flammable



Front fog lamps



Fuel pump reset



Fuse compartment



Hazard flashers



Headlamp high beams



Headlamps on



Heated rear window



Hill descent control



Horn control



Interior luggage compartment release



Jack

Introduction



Keep out of reach of children



Lighting control



Low fuel level



Low tire pressure warning



Maintain correct fluid level



Malfunction Indicator Lamp (MIL)



Note operating instructions



Panic alarm



Parking aid



Parking lamps



Passenger airbag activated



Passenger airbag deactivated



Power steering fluid



Power windows front/rear



Power window lockout



Requires registered technician



Safety alert



See Owner's Manual



See Service Manual



Side airbag



Shield the eyes



Stability control



Stability control off



Trail control



Turn Signal



Windshield defrosting system



Windshield wiping system



Windshield wash and wipe

Introduction

PERCHLORATE

Certain components in your vehicle such as airbag modules, seatbelt pretensioners and remote control batteries may contain perchlorate material. Special handling may apply for service or vehicle end of life disposal.

For more information visit:

Web Address
www.dtsc.ca.gov/hazardouswaste/perchlorate

FORD CREDIT

US Only

Ford Credit offers a full range of financing and lease plans to help you acquire your vehicle. If you have financed or leased your vehicle through Ford Credit, thank you for your business.

For assistance call 1-800-727-7000, or for more information about Ford Credit and access to the online Account Manager tool, visit www.ford.com/finance.

REPLACEMENT PARTS RECOMMENDATION

We have built your vehicle to the highest standards using quality parts. We recommend that you demand the use of genuine Ford and Motorcraft parts whenever your vehicle requires scheduled maintenance or repair. You can clearly identify genuine Ford and Motorcraft parts by looking for the Ford, FoMoCo or Motorcraft branding on the parts or their packaging.

Scheduled Maintenance and Mechanical Repairs

One of the best ways for you to make sure that your vehicle provides years of service is to have it maintained in line with our recommendations using parts that conform to the specifications detailed in this Owner's Manual.

Genuine Ford and Motorcraft parts meet or exceed these specifications.

Collision Repairs

We hope that you never experience a collision, but accidents happen sometimes.

Genuine Ford replacement collision parts meet our stringent requirements for fit, finish, structural integrity, corrosion protection and dent resistance. During vehicle development we validate that these parts deliver the intended level of protection as a whole system. A great way to know for sure you are getting this level of protection is to use genuine Ford replacement collision parts.

Warranty on Replacement Parts

Genuine Ford and Motorcraft replacement parts are the only replacement parts that benefit from a Ford Warranty.

The Ford Warranty may not cover damage caused to your vehicle as a result of failed non-Ford parts.

For additional information, refer to the terms and conditions of the Ford Warranty.

Introduction

SPECIAL NOTICES

New Vehicle Limited Warranty

For a detailed description of what is covered by your New Vehicle Limited Warranty, see your warranty guide that is available online. For more information, refer to our website and download your copy of the warranty guide.

Special Instructions

For your added safety, your vehicle is fitted with sophisticated electronic controls.



WARNING: You risk death or serious injury to yourself and others if you do not follow the instruction highlighted by the warning symbol. Failure to follow the specific warnings and instructions could result in personal injury.



WARNING: NEVER use a rearward facing child restraint on a seat protected by an ACTIVE AIRBAG in front of it, DEATH or SERIOUS INJURY to the CHILD can occur.

On Board Diagnostics Data Link Connector



WARNING: Do not connect wireless plug-in devices to the data link connector. Unauthorized third parties could gain access to vehicle data and impair the performance of safety related systems. Only allow repair facilities that follow our service and repair instructions to connect their equipment to the data link connector.

Your vehicle has an OBD Data Link Connector (DLC) that is used in conjunction with a diagnostic scan tool for vehicle diagnostics, repairs and reprogramming services. Installing an aftermarket device that uses the DLC during normal driving for purposes such as remote insurance company monitoring, transmission of vehicle data to other devices or entities, or altering the performance of the vehicle, may cause interference with or even damage to vehicle systems. We do not recommend or endorse the use of unapproved aftermarket plug-in devices. The vehicle Warranty will not cover damage caused by an aftermarket plug-in device.

Notice to Owners of Pickup Trucks and Utility Type Vehicles



WARNING: Utility vehicles have a significantly higher rollover rate than other types of vehicles.

Before you drive your vehicle, please read this Owner's Guide carefully. Your vehicle is not a passenger car. As with other vehicles of this type, failure to operate this vehicle correctly may result in loss of vehicle control, vehicle rollover, personal injury or death.

Using Your Vehicle With a Snowplow

Do not use this vehicle for snowplowing.

Your vehicle does not have a snowplowing package.

Using Your Vehicle as an Ambulance

Do not use this vehicle as an ambulance.

Introduction

Your vehicle does not have the Ambulance Preparation Package.

MOBILE COMMUNICATIONS EQUIPMENT



WARNING: Driving while distracted can result in loss of vehicle control, crash and injury. We strongly recommend that you use extreme caution when using any device that may take your focus off the road. Your primary responsibility is the safe operation of your vehicle. We recommend against the use of any hand-held device while driving and encourage the use of voice-operated systems when possible. Make sure you are aware of all applicable local laws that may affect the use of electronic devices while driving.

Using mobile communications equipment is becoming increasingly important in the conduct of business and personal affairs. However, you must not compromise your own or others' safety when using such equipment. Mobile communications can enhance personal safety and security when appropriately used, particularly in emergency situations. Safety must be paramount when using mobile communications equipment to avoid negating these benefits. Mobile communication equipment includes, but is not limited to, cellular phones, pagers, portable email devices, text messaging devices and portable two-way radios.

EXPORT UNIQUE OPTIONS

For your particular global region, your vehicle may be equipped with features and options that are different from the features and options that are described in this Owner's Manual. A market unique supplement may be supplied that complements this book. By referring to the market unique supplement, if provided, you can properly identify those features, recommendations and specifications that are unique to your vehicle. This Owner's Manual is written primarily for the U.S. and Canadian Markets. Features or equipment listed as standard may be different on units built for export. **Refer to this Owner's Manual for all other required information and warnings.**

Data Privacy



WARNING: Do not connect wireless plug-in devices to the data link connector. Unauthorized third parties could gain access to vehicle data and impair the performance of safety related systems. Only allow repair facilities that follow our service and repair instructions to connect their equipment to the data link connector.

We respect your privacy and are committed to protecting it. The information contained in this publication was correct at the time of release, but as technology rapidly changes, we recommend that you visit the local Ford website for the latest information.

Your vehicle has electronic control units that have data recording functionality and the ability to permanently or temporarily store data. This data could include information on the condition and status of your vehicle, vehicle maintenance requirements, events and malfunctions. The types of data that can be recorded are described in this section. Some of the data recorded is stored in event logs or error logs.

Note: *Error logs are reset following a service or repair.*

Note: *We may provide information in response to requests from law enforcement, other government authorities and third parties acting with lawful authority or through a legal process. Such information could be used by them in legal proceedings.*

Data recorded includes, for example:

- Operating states of system components, for example fuel level, tire pressure and battery charge level.
- Vehicle and component status, for example wheel speed, deceleration, lateral acceleration and seatbelt status.

- Events or errors in essential systems, for example headlamps and brakes.
- System responses to driving situations, for example airbag deployment and stability control.
- Environmental conditions, for example temperature.

Some of this data, when used in combination with other information, for example an accident report, damage to a vehicle or eyewitness statements, could be associated with a specific person.

Services That We Provide

If you use our services, we collect and use data, for example account information, vehicle location and driving characteristics, that could identify you. We transmit this data through a dedicated, protected connection. We only collect and use data to enable your use of our services to which you have subscribed, with your consent or where permitted by law. For additional information, see the terms and conditions of the services to which you have subscribed.

For additional information about our privacy policy, refer to the local Ford website.

Services That Third Parties Provide

We recommend that you review the terms and conditions and data privacy information for any services equipped with your vehicle or to which you subscribe. We take no responsibility for services that third parties provide.

Data Privacy

SERVICE DATA

Service data recorders in your vehicle are capable of collecting and storing diagnostic information about your vehicle. This potentially includes information about the performance or status of various systems and modules in the vehicle, such as engine, throttle, steering or brake systems. In order to properly diagnose and service your vehicle, Ford Motor Company (Ford of Canada in Canada), and service and repair facilities may access or share among them vehicle diagnostic information received through a direct connection to your vehicle when diagnosing or servicing your vehicle. Additionally, Ford Motor Company (Ford of Canada, in Canada) may, where permitted by law, use vehicle diagnostic information for vehicle improvement or with other information we may have about you, for example, your contact information, to offer you products or services that may interest you. Data may be provided to our service providers such as part suppliers that may help diagnose malfunctions, and who are similarly obligated to protect data. We retain this data only as long as necessary to perform these functions or to comply with law. We may provide information where required in response to official requests to law enforcement or other government authorities or third parties acting with lawful authority or court order, and such information may be used in legal proceedings. For U.S. only (if equipped), if you choose to use connected apps and services, you consent that certain diagnostic information may also be accessed electronically by Ford Motor Company and Ford authorized service facilities, and that the diagnostic information may be used to provide services to you, personalizing your experience, troubleshoot, and to improve products and services and offer you products and services that may interest

you, where permitted by law. For Canada only, for more information, please review the Ford of Canada privacy policy at www.ford.ca, including our U.S. data storage and use of service providers in other jurisdictions who may be subject to legal requirements in Canada, the United States and other countries applicable to them, for example, lawful requirements to disclose personal information to governmental authorities in those countries.

EVENT DATA

This vehicle is equipped with an event data recorder. The main purpose of an event data recorder is to record, in certain crash or near crash-like situations, such as an airbag deployment or hitting a road obstacle; this data will assist in understanding how a vehicle's systems performed. The event data recorder is designed to record data related to vehicle dynamics and safety systems for a short period of time, typically 30 seconds or less.

The event data recorder in this vehicle is designed to record such data as:

- How various systems in your vehicle were operating.
- Whether or not the driver and passenger seatbelts were buckled/fastened.
- How far (if at all) the driver was depressing the accelerator and/or the brake pedal.
- How fast the vehicle was traveling.
- Where the driver was positioning the steering wheel.

This data can help provide a better understanding of the circumstances in which crashes and injuries occur.

Data Privacy

Note: *Event data recorder data is recorded by your vehicle only if a non-trivial crash situation occurs; no data is recorded by the event data recorder under normal driving conditions and no personal data or information (for example name, gender, age, and crash location) is recorded. However, parties, such as law enforcement, could combine the event data recorder data with the type of personally identifying data routinely acquired during a crash investigation.*

To read data recorded by an event data recorder, special equipment is required, and access to the vehicle or the event data recorder is needed. In addition to the vehicle manufacturer, other parties, such as law enforcement, that have such special equipment, can read the information if they have access to the vehicle or the event data recorder.

SETTINGS DATA

Your vehicle has electronic control units that have the ability to store data based on your personalized settings. The data is stored locally in the vehicle or on devices that you connect to it, for example, a USB drive or digital music player. You can delete some of this data and also choose whether to share it through the services to which you subscribe. See **Settings** (page 458).

Comfort and Convenience Data

Data recorded includes, for example:

- Seat and steering wheel position.
- Climate control settings.
- Radio presets.

Entertainment Data

Data recorded includes, for example:

- Music, videos or album art.
- Contacts and corresponding address book entries.
- Navigation destinations.

CONNECTED VEHICLE DATA



The modem has a SIM. The modem was enabled when your vehicle was built and periodically sends messages to stay connected to the cell phone network, receive automatic software updates and send vehicle-related information to us, for example diagnostic information. These messages could include information that identifies your vehicle, the SIM and the electronic serial number of the modem. Cell phone network service providers could have access to additional information, for example cell phone network tower identification. For additional information about our privacy policy, visit www.FordConnected.com or refer to your local Ford website.

Note: *The modem continues to send this information unless you disable the modem or stop the modem from sharing vehicle data by changing the modem settings. See **Connected Vehicle** (page 414).*

Note: *The service can be unavailable or interrupted for a number of reasons, for example environmental or topographical conditions and data plan coverage.*

Note: *To find out if your vehicle has a modem, visit www.FordConnected.com.*

Data Privacy

MOBILE DEVICE DATA

If you connect a mobile device to your vehicle, you can display data from your device on the touchscreen for example, music and album art. You can share your vehicle data with mobile apps on your device through the system. See **Apps** (page 455).

The mobile apps function operates by your connected device sending data to us in the United States. The data is encrypted and includes, for example, the vehicle identification number of your vehicle, the SYNC module serial number, odometer, enabled apps, usage statistics and debugging information. We retain it only as long as necessary to provide the service, to troubleshoot, for continuous improvement and to offer you products and services that may be of interest to you according to your preferences and where allowed by law.

If you connect a cell phone to the system, the system creates a profile that links to that cell phone. The cell phone profile enables more mobile features and efficient operation. The profile contains, for example data from your phonebook, read and unread text messages and call history, including history of calls when your cell phone was not connected to the system.

If you connect a media device, the system creates and retains a media device index of supported media content. The system also records a short diagnostic log of approximately 10 minutes of all recent system activity.

The cell phone profile, media device index and diagnostic log remain in your vehicle unless you delete them and are generally accessible only in your vehicle when you connect your cell phone or media device. If you no longer plan to use the system or your vehicle, we recommend you use the master reset function to erase the stored information. See **Settings** (page 458).

System data cannot be accessed without special equipment and access to your vehicle's module.

For additional information about our privacy policy, refer to the local Ford website.

Note: *To find out if your vehicle has connectivity technology, visit www.FordConnected.com.*

EMERGENCY CALL SYSTEM DATA

When the emergency call system is active, it may disclose to emergency services that your vehicle has been in a crash involving the deployment of an airbag or activation of the fuel pump shut-off. Certain versions or updates to the emergency call system may also be capable of electronically or verbally disclosing to emergency services operators your vehicle location or other details about your vehicle or crash to assist emergency services operators to provide the most appropriate emergency services. If you do not want to disclose this information, do not activate the emergency call system.

Note: *You cannot deactivate emergency call systems that are required by law.*

Environment

PROTECTING THE ENVIRONMENT

You can take significant steps toward protecting the environment with correct vehicle usage and the authorized disposal of waste, cleaning and lubrication materials.

For additional information about our sustainability progress and initiatives, visit www.sustainability.ford.com.

At a Glance

AT A GLANCE - ST

Exterior

- Front and rear fascias feature unique ST grille and unique finish.
- ST badging in front grille and on rear liftgate.
- Trim features unique ST gloss black finish.
- E-X-P-L-O-R-E-R lettering across hood.
- Blackout treatment on headlight and taillight lenses.

Interior

- Unique ST interior trim.
- Ford Performance sill plates.
- ST flat-bottom steering wheel with integrated transmission shift paddle controls.
- Selectable Drive Mode controller with 7 settings (Normal, Eco, Sport, Trail, Slippery, Deep Snow/Sand and Tow/Haul).
- Unique electronic sound enhancement in Sport Selectable Drive Mode.

Chassis

- Unique ST-tuned suspension featuring 32 N/mm front coil springs and a 34 mm hollow front stabilizer bar and 106 N/mm rear coil springs and a 21.7 mm hollow rear stabilizer bar.
- Standard ST brake system consists of 345 mm diameter vented front rotors with two piston calipers and low-dust linings; 326 mm solid rear rotors with single-piston brake calipers and electric integrated park brake with low dust linings.

- Optional ST braking system includes 363 mm diameter vented front rotors with heavy duty two-piston calipers and low-dust linings; 350 mm diameter vented rear rotors with heavy-duty single-piston brake calipers and electric integrated park brake with low-dust linings; system requires 21 x 9-inch wheels and P275/45R21 all-season tires.
- Optional low-metallic brake linings are included with optional P275/45R21 summer tire (late availability).
- ST-tuned electric power assist steering rack and pinion.
- AdvanceTrac with stability enhancement system with four modes: Default, Traction Control Off, Sport and Disabled.
- Aluminum ST 20 in (50.8 cm) x 8.5 in (21.6 cm) wheels standard; 21 in (53.3 cm) x 9 in (22.9 cm) wheels optional.
- P255/55R20 all-season tires or optional P275/45R21 all-season tires.

Powertrain

- 3.0L V6 DOHC GTDI engine, 400 horsepower, 415 lb-ft.
- 10R60 10-speed automatic transmission with SelectShift manual shift mode.
- 3.58 axle ratios.
- Unique transmission calibration in Sport Selectable Drive Mode.
- Dual exhaust with quad-tip outlets.

At a Glance

INSTRUMENT PANEL

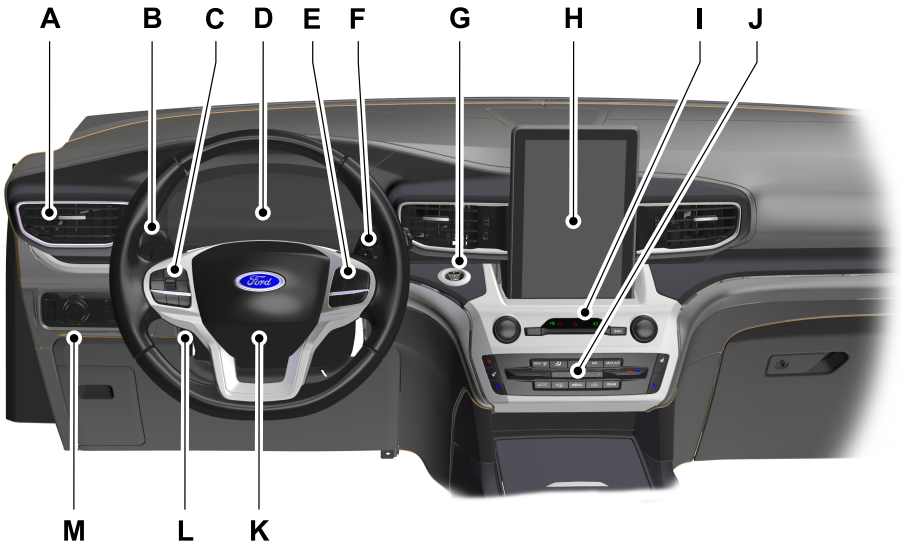

E282065

- A Air vents.
- B Direction indicator. See **Direction Indicators** (page 89).
- C Cruise control. See **Cruise Control** (page 81). Audio control. See **Audio Control** (page 81).
- D Information display. See **General Information** (page 115).
- E Information display control. See **Information Display Control** (page 82).
- F Wiper lever. See **Windshield Wipers** (page 83).
- G Ignition switch. See **Keyless Starting** (page 169).
- H Information and Entertainment display.
- I Hazard flasher switch. See **Hazard Flashers** (page 292).
- J Climate control. See **Automatic Climate Control** (page 137).
- K Horn.

At a Glance

- L Steering wheel adjustment. See **Adjusting the Steering Wheel** (page 79).
- M Lighting control. See **Lighting Control** (page 86). Power liftgate release. See **Power Liftgate** (page 73).

Child Safety

GENERAL INFORMATION

See the following sections for directions on how to properly use safety restraints for children.



WARNING: Always make sure your child is secured properly in a device that is appropriate for their height, age and weight. Child safety restraints must be bought separately from your vehicle. Failure to follow these instructions and guidelines may result in an increased risk of serious injury or death to your child.



WARNING: All children are shaped differently. The National Highway Traffic Safety Administration and other safety organizations, base their recommendations for child restraints on probable child height, age and weight thresholds, or on the minimum requirements of the law. We recommend that you check with a NHTSA Certified Child Passenger Safety Technician

(CPST) to make sure that you properly install the child restraint in your vehicle and that you consult your pediatrician to make sure you have a child restraint appropriate for your child. To locate a child restraint fitting station and CPST, contact NHTSA toll free at 1-888-327-4236 or go to www.nhtsa.dot.gov. In Canada, contact Transport Canada toll free at 1-800-333-0371 or go to www.tc.gc.ca to find a Child Car Seat Clinic in your area. Failure to properly restrain children in child restraints made especially for their height, age and weight, may result in an increased risk of serious injury or death to your child.



WARNING: On hot days, the temperature inside the vehicle can rise very quickly. Exposure of people or animals to these high temperatures for even a short time can cause death or serious heat related injuries, including brain damage. Small children are particularly at risk.

Child Safety

Recommendations for Safety Restraints for Children

Child	Child Size, Height, Weight, or Age	Recommended Restraint Type
Infants or toddlers	Children weighing 40 lb (18 kg) or less (generally age four or younger).	Use a child restraint (sometimes called an infant carrier, convertible seat, or toddler seat).
Small children	Children who have outgrown or no longer properly fit in a child restraint (generally children who are less than 57 in (1.45 m) tall, are greater than age four and less than age 12, and between 40 lb (18 kg) and 80 lb (36 kg) and upward to 100 lb (45 kg) if recommended by your child restraint manufacturer).	Use a belt-positioning booster seat.
Larger children	Children who have outgrown or no longer properly fit in a belt-positioning booster seat (generally children who are at least 57 in (1.45 m) tall or greater than 80 lb (36 kg) or 100 lb (45 kg) if recommended by child restraint manufacturer).	Use a vehicle seatbelt having the lap belt snug and low across the hips, shoulder belt centered across the shoulder and chest, and seat backrest upright.

- You are required by law to properly use child restraints for infants and toddlers in the United States, Canada and Mexico.
- Many states and provinces require that small children use approved booster seats until they reach age eight, a height of 57 in (1.45 m) tall, or 80 lb (36 kg). Check your local and state or provincial laws for specific requirements about the safety of children in your vehicle.
- When possible, properly restrain children 12 years of age and under in a rear seating position of your vehicle. Accident statistics suggest that children are safer when properly restrained in the rear seating positions than in a front seating position. See **Front Passenger Sensing System** (page 48).
- When installing a rear facing child restraint, adjust the vehicle seats to avoid interference between the child restraint and the vehicle seat in front of the child restraint.

Child Safety

INSTALLING CHILD RESTRAINTS

Child Seats



E142594

Use a child restraint (sometimes called an infant carrier, convertible seat, or toddler seat) for Infants, toddlers and children weighing 40 lb (18 kg) or less (generally four-years-old or younger).

Using Lap and Shoulder Belts



WARNING: Do not place a rearward facing child restraint in front of an active airbag. Failure to follow this instruction could result in personal injury or death.



WARNING: Properly secure children 12 years old and under in a rear seating position whenever possible. If you are unable to properly secure all children in a rear seating position, properly secure the largest child on the front seat. If you must use a forward facing child restraint on the front seat, move the seat as far back as possible. Failure to follow these instructions could result in personal injury or death.



WARNING: Depending on where you secure a child restraint, and depending on the child restraint design, you may block access to certain seatbelt buckle assemblies and LATCH lower anchors, rendering those features potentially unusable. To avoid risk of injury, make sure occupants only use seating positions where they are able to be properly restrained.

When installing a child restraint with combination lap and shoulder belts:

- Use the correct seatbelt buckle for that seating position.
- Insert the belt tongue into the proper buckle until you hear a snap and feel it latch. Make sure the tongue is securely fastened in the buckle.
- Keep the buckle release button pointing up and away from the child restraint, with the tongue between the child restraint and the release button, to prevent accidental unbuckling.
- Place the vehicle seat in the upright position before you install the child restraint.
- For second row seating positions, adjust the recliner slightly to improve child restraint fit. If needed, remove the head restraints.
- For third row seating positions, stow the head restraints to improve child restraint fit. See **Head Restraints** (page 144).
- Put the seatbelt in the automatic locking mode. See Step 5 in the procedure that follows. This vehicle does not require the use of a locking clip.

Perform the following steps when installing the child restraint with combination lap and shoulder belts:

Child Safety

Note: Although the child restraint illustrated is a forward facing child restraint, the steps are the same for installing a rear facing child restraint.

Note: Follow all instructions provided by the manufacturer of the child restraint regarding the necessary and proper use of the lock-off device. In some instances, the manufacturer provides these devices only for use in vehicles with seatbelt systems that would otherwise require a locking clip.

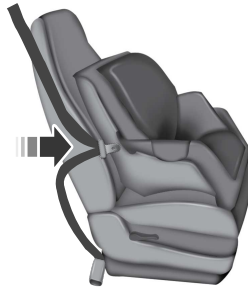

3. While holding the shoulder and lap belt portions together, route the tongue through the child restraint according to the child restraint manufacturer's instructions. Make sure you do not twist the belt webbing.



1. Position the child restraint in a seat with a combination lap and shoulder belt.



2. After positioning the child restraint in the proper seating position, pull down on the shoulder belt and then grasp the shoulder belt and lap belt together behind the belt tongue.

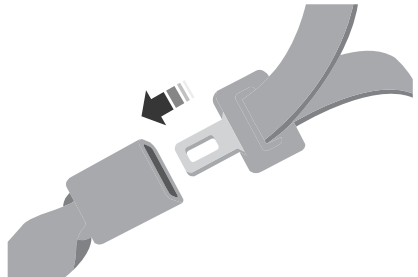

4. Insert the belt tongue into the proper buckle (the buckle closest to the direction the tongue is coming from) for that seating position until you hear a snap and feel the latch engage. Make sure that you securely latch the tongue by pulling on it.

Child Safety



5. To put the retractor in the automatic locking mode, grasp the shoulder portion of the belt and pull downward until you pull all of the belt out.

Note: The automatic locking mode is available on the front passenger and rear seats.

6. Allow the belt to retract to remove slack. The belt clicks as it retracts to indicate it is in the automatic locking mode.
7. Try to pull the belt out of the retractor to make sure the retractor is in the automatic locking mode. You should not be able to pull more belt out. If the retractor did not lock, unbuckle the belt and repeat Steps 5 and 6.

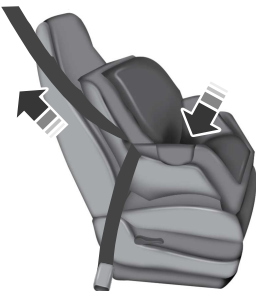

8. Remove remaining slack from the belt. Force the seat down with extra weight, for example, by pressing down or kneeling on the child restraint as you pull up on the shoulder belt to force slack from the belt. This is necessary to remove the remaining slack that exists once you add the extra weight of the child to the child restraint. It also helps to achieve the proper snugness of the child restraint to your vehicle. Sometimes, a slight lean toward the buckle provides extra help to remove remaining slack from the belt.
9. If the child restraint has a tether strap, attach it now.

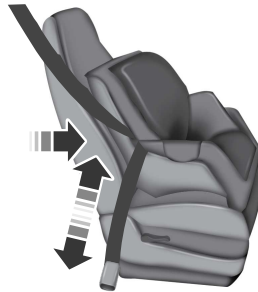

10. Before placing the child in the seat, forcibly move the seat forward and back to make sure you have the seat securely held in place. To check this, grab the seat at the belt path and attempt to move it side to side and forward and back. There should be no more than 1 in (2.5 cm) of movement for proper installation.

We recommend checking with a NHTSA Certified Child Passenger Safety Technician to make sure you properly installed the child restraint. In Canada, check with Transport Canada for referral to a Child Car Seat Clinic.

Child Safety

Using Lower Anchors and Tethers for Children (LATCH)



WARNING: Do not attach two child safety restraints to the same anchor. In a crash, one anchor may not be strong enough to hold two child safety restraint attachments and may break, causing serious injury or death.



WARNING: Depending on where you secure a child restraint, and depending on the child restraint design, you may block access to certain seatbelt buckle assemblies and LATCH lower anchors, rendering those features potentially unusable. To avoid risk of injury, make sure occupants only use seating positions where they are able to be properly restrained.

The LATCH system has three vehicle anchor points: two lower anchors where the seat backrest and seat cushion meet (called the seat bight) and one top tether anchor behind that seating position.

LATCH compatible child restraints have two rigid or webbing mounted attachments that connect to the two lower anchors at the LATCH equipped seating positions in your vehicle. This type of attachment method eliminates the need to use seatbelts to attach the child restraint. However, you can still use the seatbelt to attach the child restraint. For forward-facing child restraints, you must also attach the top tether strap to the proper top tether anchor if one came with your child restraint.

Your vehicle has LATCH lower anchors for child restraint installation at the seating positions marked with the child restraint symbol.

Second Row Bucket Seats and Third Row Seats

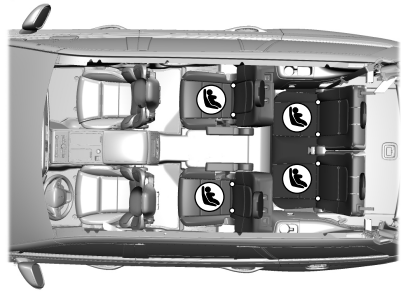

Second Row Bench Seats and Third Row Seats

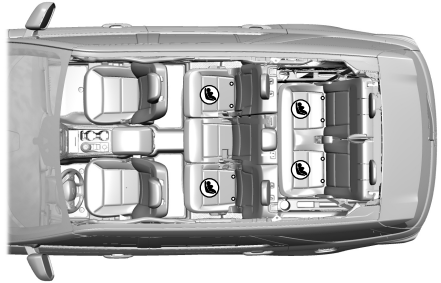

E144054

Child Safety

The LATCH anchors are at the rear section of the rear seat between the cushion and seat backrest below the symbols as shown. Follow the child restraint manufacturer's instructions to properly install a child restraint with LATCH attachments.

Follow the instructions on attaching child restraints with tether straps. See Using Tether Straps later in this chapter.

Attach LATCH lower attachments of the child restraint only to the anchors shown.

Use of Inboard Lower Anchors from the Outboard Seating Positions (Center Seating Use)



WARNING: The standardized spacing for LATCH lower anchors is 11 in (280 mm) center to center. Do not use LATCH lower anchors for the center seating position unless the child restraint manufacturer's instructions permit and specify using anchors spaced at least as far apart as those in this vehicle.

The lower anchors at the center of the second row bench seat are spaced 20.5 in (52 cm) apart. The standardized spacing for LATCH lower anchors is 11 in (28 cm) center to center. You cannot install a child restraint with rigid LATCH attachments at the center seating position. You can only use LATCH compatible child restraints with attachments on belt webbing at this seating position provided that the child restraint manufacturer's instructions permit use with the anchor spacing stated. Do not attach a child restraint to any lower anchor if you have an adjacent child restraint attached to that anchor.

Each time you use the child restraint, check that you properly attached the seat to the lower anchors and tether anchor, if applicable. Tug the child restraint from side to side and forward and back where you secured it to your vehicle. The child restraint should move less than 1 in (2.5 cm) if you properly install the seat.

If you do not properly anchor the child restraint, the risk of injury to a child greatly increases in a crash.

Combining Seatbelt and LATCH Lower Anchors for Attaching Child Restraints

When used in combination, you can attach either the seatbelt or the LATCH lower anchors first, provided you achieve a proper installation. Attach the tether strap afterward, if included with the child restraint.

Using Tether Straps



Many forward-facing child restraints include a tether strap which extends from the back of the child restraint and hooks to an anchoring point called the top tether anchor. Tether straps are available as an accessory for many older child restraints.

Contact the manufacturer of your child restraint for information about ordering a tether strap, or to obtain a longer tether strap if the tether strap on your child restraint does not reach the appropriate top tether anchor in your vehicle.

Once you install the child restraint using either the seatbelt, the lower anchors of the LATCH system, or both, you can attach the top tether strap.

The tether strap anchors in your vehicle are in the following positions (shown from top view):

Child Safety

Second Row Bucket Seats and Third Row Seats

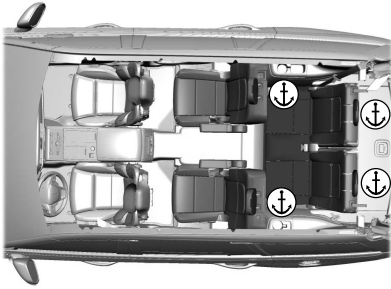

Second Row Bench Seats and Third Row Seats

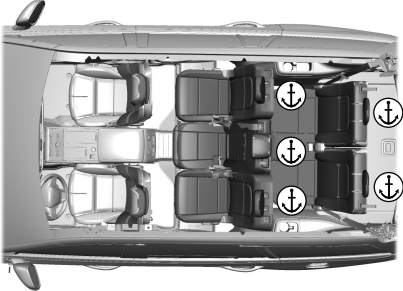

Perform the following steps to install a child restraint with tether anchors:

Note: If you install a child restraint with rigid LATCH attachments, do not tighten the tether strap enough to lift the child restraint off your vehicle seat cushion when the child is seated in it. Keep the tether strap just snug without lifting the front of the child restraint. Keeping the child restraint just touching your vehicle seat gives the best protection in a severe crash.

For second row outermost seating positions, route the child restraint tether strap over the seat backrest, under the head restraint and between the head restraint posts. If needed, remove the head restraint to improve the fit of the child restraint or tether strap.

For the second row center seating position, route the child restraint tether strap over the top of the head restraint. If needed, remove the head restraint to improve the fit of the child restraint or tether strap. See **Head Restraints** (page 144).

For third row seating positions, route the child restraint tether strap over the seat backrest, under the head restraint and between the head restraint posts. If needed, fold the head restraint down to improve the fit of the child restraint or tether strap. See **Head Restraints** (page 144).

1. Route the tether strap.
2. Locate the correct anchor for the selected seating position.
3. Clip the tether strap to the anchor as shown. The tether hook may be twisted $\frac{1}{2}$ turn to improve installation. If you clip the tether strap incorrectly, the child restraint may not be retained properly in the event of a crash.



E190833

Child Safety

4. Tighten the child restraint tether strap according to the manufacturer's instructions.

If you do not properly anchor the child restraint, the risk of injury to a child increases greatly in a crash.

If your child restraint system has a tether strap, and the child restraint manufacturer recommends its use, we also recommend its use.

Second Row Bucket Seats

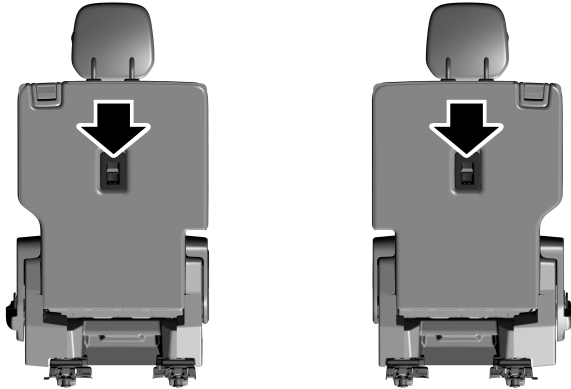

E251594

Child Safety

Second Row Bench Seats



E251593

Third Row Seats

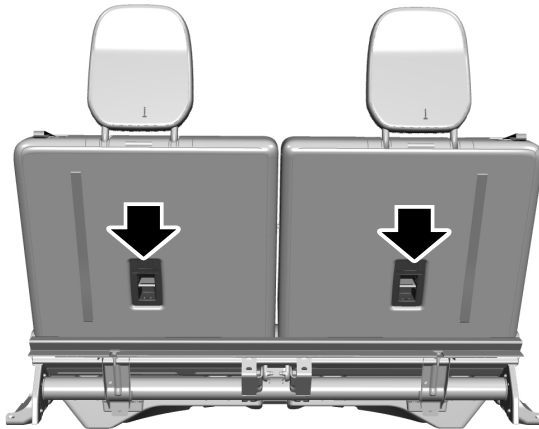

E286303

Note: The cargo tie downs at the rear edge of the floor are not tether anchors.

Child Safety

BOOSTER SEATS



WARNING: Do not put the shoulder section of the seatbelt or allow the child to put the shoulder section of the seatbelt under their arm or behind their back. Failure to follow this instruction could reduce the effectiveness of the seatbelt and increase the risk of injury or death in a crash.

Use a belt-positioning booster seat for children who have outgrown or no longer properly fit in a child safety restraint (generally children who are less than 57 in (1.45 m) tall, are greater than age 4 and less than age 12, and between 40 lb (18 kg) and 80 lb (36 kg) and upward to 100 lb (45 kg) if recommended by your child restraint manufacturer). Many state and provincial laws require that children use approved booster seats until they reach age eight, a height of 57 in (1.45 m) tall, or 80 lb (36 kg).

Booster seats should be used until you can answer YES to ALL of these questions when seated without a booster seat:

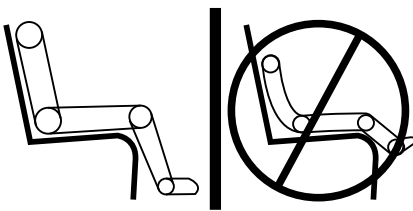

- Can the child sit all the way back against their vehicle seat backrest with knees bent comfortably at the edge of the seat cushion?
- Can the child sit without slouching?

- Does the lap belt rest low across the hips?
- Is the shoulder belt centered on the shoulder and chest?
- Can the child stay seated like this for the whole trip?

Always use booster seats in conjunction with your vehicle lap and shoulder belt.

Types of Booster Seats



- Backless booster seats

If your backless booster seat has a removable shield, remove the shield. If a vehicle seating position has a low seat backrest or no head restraint, a backless booster seat may place your child's head (as measured at the tops of the ears) above the top of the seat. In this case, move the backless booster to another seating position with a higher seat backrest or head restraint and lap and shoulder belts, or consider using a high back booster seat.

Child Safety



If, with a backless booster seat, you cannot find a seating position that adequately supports your child's head, a high back booster seat would be a better choice.

Children and booster seats vary in size and shape. Choose a booster that keeps the lap belt low and snug across the hips, never up across the stomach, and lets you adjust the shoulder belt to cross the chest and rest snugly near the center of the shoulder. The following drawings compare the ideal fit (center) to a shoulder belt uncomfortably close to the neck and a shoulder belt that could slip off the shoulder. The drawings also show how the lap belt should be low and snug across the child's hips.

- High back booster seats



Child Safety

If the booster seat slides on the vehicle seat upon which it is being used, placing a rubberized mesh sold as shelf or carpet liner under the booster seat may improve this condition. Do not introduce any item thicker than this under the booster seat. Check with the booster seat manufacturer's instructions.

CHILD RESTRAINT POSITIONING



WARNING: Do not place a rearward facing child restraint in front of an active airbag. Failure to follow this instruction could result in personal injury or death.



WARNING: Properly secure children 12 years old and under in a rear seating position whenever possible. If you are unable to properly secure all children in a rear seating position, properly secure the largest child on the front seat. If you must use a forward facing child restraint on the front seat, move the seat as far back as possible. Failure to follow these instructions could result in personal injury or death.



WARNING: Always carefully follow the instructions and warnings provided by the manufacturer of any child restraint to determine if the restraint device is appropriate for your child's size, height, weight, or age. Follow the child restraint manufacturer's instructions and warnings provided for installation and use in conjunction with the instructions

and warnings provided by your vehicle manufacturer. A safety seat that is improperly installed or utilized, is inappropriate for your child's height, age, or weight or does not properly fit the child may increase the risk of serious injury or death.



WARNING: Do not allow a passenger to hold a child on their lap when your vehicle is moving. Failure to follow this instruction could result in personal injury or death in the event of a sudden stop or crash.



WARNING: Do not use pillows, books or towels to boost your child's height. Failure to follow this instruction could result in personal injury or death.



WARNING: Properly secure child restraints or booster seats when they are not in use. They could become projectiles in a sudden stop or crash. Failure to follow this instruction could result in personal injury or death.



WARNING: Do not put the shoulder section of the seatbelt or allow the child to put the shoulder section of the seatbelt under their arm or behind their back. Failure to follow this instruction could reduce the effectiveness of the seatbelt and increase the risk of injury or death in a crash.



WARNING: Do not leave children or pets unattended in your vehicle. Failure to follow this instruction could result in personal injury or death.

Child Safety

Recommendations for Attaching Child Safety Restraints for Children

Restraint Type	Combined Weight of Child and Child Restraint	Use Any Attachment Method as Indicated Below by X				
		LATCH (Lower Anchors and Top Tether Anchor)	LATCH (Lower Anchors Only)	Seatbelt and Top Tether Anchor	Seatbelt and LATCH (Lower Anchors and Top Tether Anchor)	Seatbelt Only
Rear facing child restraint	Up to 65 lb (29.5 kg)		X			X
Rear facing child restraint	Over 65 lb (29.5 kg)					X
Forward facing child restraint	Up to 65 lb (29.5 kg)	X		X	X	
Forward facing child restraint	Over 65 lb (29.5 kg)			X	X	

Note: The child restraint must rest tightly against the vehicle seat upon which it is installed. It may be necessary to lift or remove the head restraint. See **Seats** (page 144).

CHILD SAFETY LOCKS



WARNING: You cannot open the rear doors from inside if you have put the child safety locks on.

Child Safety

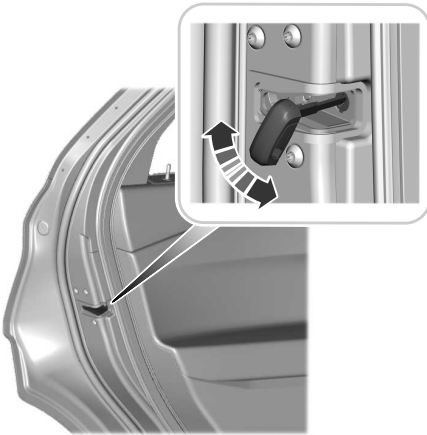

A child safety lock is on the rear edge of each rear door. You must set the child safety lock separately on each door.

Left-Hand Side

Turn the key clockwise to switch the child lock on and counter clockwise to switch it off.

Right-Hand Side

Turn the key counter clockwise to switch the child lock on and clockwise to switch it off.

Note: To make sure the child safety lock is on, pull the inside door handle twice to verify the door does not open.

Note: To open the rear doors from inside the vehicle when the child lock is engaged, roll down the rear window and use the outside door handle. Or have someone outside the vehicle open the door.

Seatbelts

PRINCIPLE OF OPERATION



WARNING: Always drive and ride with your seatback upright and the lap belt snug and low across the hips.



WARNING: Children must always be properly restrained.



WARNING: Do not allow a passenger to hold a child on their lap when your vehicle is moving. Failure to follow this instruction could result in personal injury or death in the event of a sudden stop or crash.



WARNING: All occupants of your vehicle, including the driver, should always properly wear their seatbelts, even when an airbag supplemental restraint system is provided. Failure to properly wear your seatbelt could seriously increase the risk of injury or death.



WARNING: It is extremely dangerous to ride in a cargo area, inside or outside of a vehicle. In a crash, people riding in these areas are more likely to be seriously injured or killed. Do not allow people to ride in any area of your vehicle that is not equipped with seats and seatbelts. Make sure everyone in your vehicle is in a seat and properly using a seatbelt. Failure to follow this warning could result in serious personal injury or death.



WARNING: In a rollover crash, an unbelted person is significantly more likely to die than a person wearing a seatbelt.



WARNING: Each seating position in your vehicle has a specific seatbelt assembly made up of one buckle and one tongue designed to be used as a pair. Use the shoulder belt on the outside shoulder only. Never wear the shoulder belt under the arm. Never use a single seatbelt for more than one person.



WARNING: Even with advanced restraints systems, properly restrain children 12 and under in a rear seating position. Failure to follow this could seriously increase the risk of injury or death.



WARNING: Seatbelts and seats may be hot in a vehicle that is in the sunshine. The hot seatbelts or seats may burn a small child. Check seat covers and buckles before you place a child anywhere near them.

All seating positions in your vehicle have lap and shoulder seatbelts. All occupants of the vehicle should always properly wear their seatbelts, even when an airbag supplemental restraint system is provided.

The seatbelt system consists of:

- Lap and shoulder seatbelts.
- Shoulder seatbelt with automatic locking mode, (except driver seatbelt).
- Height adjuster at the front outermost seating positions.
- Seatbelt pretensioners at the front outermost and second row outermost seating positions.
- Belt tension sensor at the front outermost passenger seating position.



- Seatbelt warning light and chime.

Seatbelts



- Crash sensors and monitoring system with readiness indicator.

The seatbelt pretensioners are designed to tighten the seatbelts when activated. In frontal and near-frontal crashes, the seatbelt pretensioners may be activated alone or, if the crash is of sufficient severity, together with the front airbags. The pretensioners may also activate when a Safety Canopy airbag deploys.

FASTENING THE SEATBELTS

The front outboard and rear safety restraints in the vehicle are combination lap and shoulder belts.

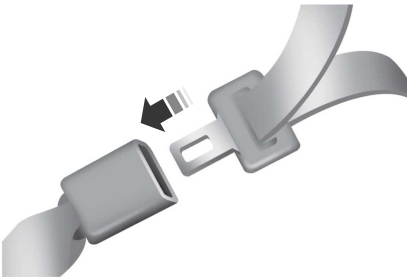

1. Insert the belt tongue into the proper buckle (the buckle closest to the direction the tongue is coming from) until you hear a snap and feel it latch. Make sure that you securely fasten the tongue in the buckle.

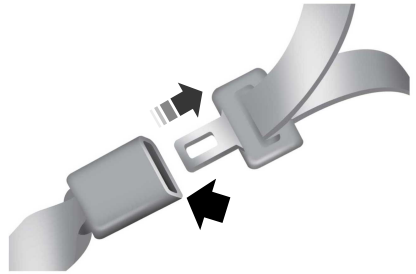

2. To unfasten, press the release button and remove the tongue from the buckle.

Using Seatbelts During Pregnancy

 **WARNING:** Always ride and drive with your seatback upright and properly fasten your seatbelt. Fit the lap portion of the seatbelt snugly and low across the hips. Position the shoulder portion of the seatbelt across your chest. Pregnant women must follow this practice. See the following figure.

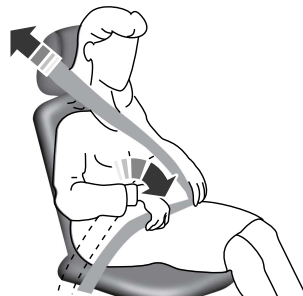

Seatbelts

Pregnant women should always wear their seatbelt. Position the lap belt portion of a combination lap and shoulder belt low across the hips below the belly and worn as tight as comfort allows. Position the shoulder belt to cross the middle of the shoulder and the center of the chest.

Seatbelt Locking Modes



WARNING: If your vehicle is involved in a crash, have the seatbelts and associated components inspected as soon as possible. Failure to follow this instruction could result in personal injury or death.

All safety restraints in the vehicle are combination lap and shoulder belts. The driver seatbelt has the first type of locking mode, and the front outboard passenger and rear seat seatbelts have both types of locking modes described as follows:

Vehicle Sensitive Mode

This is the normal retractor mode, which allows free shoulder belt length adjustment to your movements and locking in response to vehicle movement. For example, if the driver brakes suddenly or turns a corner sharply, or the vehicle receives an impact of about 5 mph (8 km/h) or more, the combination seatbelts lock to help reduce forward movement of the driver and passengers.

In addition, the design of the retractor is to lock if you pull the webbing out too quickly. If the seatbelt retractor locks, slowly lower the height adjuster to allow the seatbelt to retract. If the retractor does not unlock, pull the seatbelt out slowly then feed a

small length of webbing back toward the stowed position. For rear seatbelts, recline the rear seat backrest or push the seat backrest cushion away from the seatbelt. Feed a small length of webbing back toward the stowed position.

Automatic Locking Mode

In this mode, the shoulder belt automatically pre-locks. The belt retracts to remove any slack in the shoulder belt. The automatic locking mode is not available on the driver seatbelt.

When to Use the Automatic Locking Mode

Use this mode any time you install a child safety seat, except a booster, in passenger front or rear seating positions. Properly restrain children 12 years old and under in a rear seating position whenever possible. See **Child Safety** (page 23).

How to Use the Automatic Locking Mode



1. Buckle the combination lap and shoulder belt.
2. Grasp the shoulder portion and pull downward until you pull the entire belt out. Allow the belt to retract. As the belt retracts, you will hear a clicking sound. This indicates the seatbelt is now in the automatic locking mode.

Seatbelts

How to Disengage the Automatic Locking Mode

Unbuckle the combination lap and shoulder belt and allow it to retract completely to disengage the automatic locking mode and turn on the vehicle sensitive (emergency) locking mode.

SEATBELT HEIGHT ADJUSTMENT



WARNING: Position the seatbelt height adjuster so that the seatbelt rests across the middle of your shoulder. Failure to adjust the seatbelt correctly could reduce its effectiveness and increase the risk of injury in a crash.

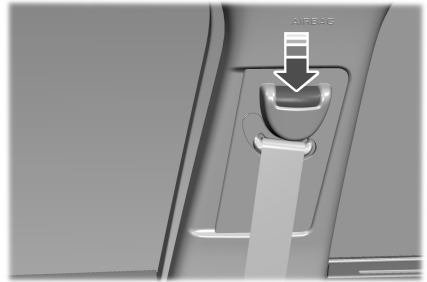

1. Adjust the height of the shoulder belt so the belt rests across the middle of your shoulder.
2. Slide the adjuster up to raise the belt. Press the button and slide it down to lower the belt.

SEATBELT WARNING LAMP AND INDICATOR CHIME



This lamp illuminates and an indicator chime will sound if the driver seatbelt has not been fastened when the vehicle's ignition is turned on.

Conditions of operation

If	Then
The driver seatbelt is not buckled before the ignition switch is turned to the on position...	The seatbelt warning lamp illuminates and the indicator chime sounds for a few seconds.
The driver seatbelt is buckled while the warning lamp is illuminated and the indicator chime is sounding...	The seatbelt warning lamp and indicator chime turn off.
The driver seatbelt is buckled before the ignition switch is turned to the on position...	The seatbelt warning lamp and indicator chime remain off.

Seatbelts

SEATBELT REMINDER



WARNING: The system will only provide protection when you use the seatbelt correctly.

This system monitors all seating positions and provides audio and graphic feedback.



This lamp illuminates and a warning tone sounds if you do not fasten your seatbelt when you switch the ignition on. The lamp and tone switch off when you fasten your seatbelt or about one minute has elapsed.

When the initial warning expires for the driver, more warnings are provided for the driver and front outermost passenger. This lamp illuminates and a warning tone sounds if you or your front passenger do not fasten the seatbelt buckle and the vehicle speed exceeds 6 mph (9.7 km/h). To deactivate the warning, see Deactivating and Activating the Belt-Minder Feature.

Note: To avoid inadvertent warnings, do not place large objects on the front passenger seat.



This lamp illuminates when you switch the ignition on, identifying the number of seating positions with fastened buckles. It illuminates again when a seating position changes from unfastened to fastened.

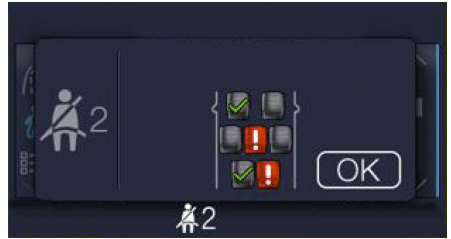

This warning displays and a tone sounds if an occupant unfastens the rear seatbelt buckle or it becomes unfastened.

Note: If a rear seat is unoccupied, or an occupant never fastens the seatbelt buckle to begin with, the warning will not display.

Note: Front seating positions appear in this warning display. Warnings for unfastened front seatbelt buckles appear in the initial warning lamp.

Seatbelt Status

To view the seatbelt status, use the information display controls on the steering wheel. See **General Information** (page 115).

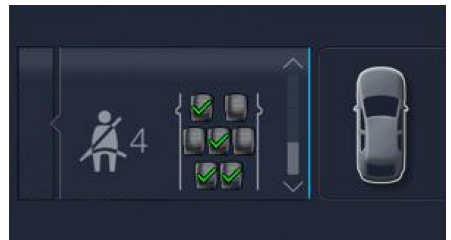

Seatbelts

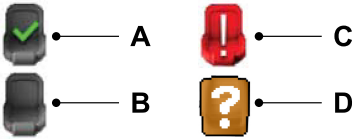

- A Seatbelt fastened.
- B Seatbelt not fastened.
- C Seatbelt recently unfastened.
- D Fault

Deactivating and Activating the Belt-Minder Feature - Front outermost seats only



WARNING: While the system allows you to deactivate it, this system is designed to improve your chances of being safely belted and surviving an accident. We recommend you leave the system activated for yourself and others who may use the vehicle.

Note: *The driver and front passenger warnings switch on and off independently. When you perform this procedure for one seating position, do not buckle the other position as this terminates the process.*

Read Steps 1 - 4 before starting the procedure.

Make sure that:

- You set the parking brake.
- The transmission is in park (P).
- The ignition is off.
- You close all vehicle doors.
- You unbuckle the driver and front passenger seatbelts.

1. Switch the ignition on. Do not start the engine.
2. Wait until the seatbelt warning lamp turns off (about one minute). After Step 2, wait an additional five seconds before proceeding with Step 3. Once you start Step 3, you must complete the procedure within 60 seconds.
3. For the seating position you are switching off, buckle then unbuckle the seatbelt three times at a moderate speed, ending in the unbuckled state. After Step 3, the seatbelt warning lamp turns on.
 - This switches the feature off if it is currently on.
 - This switches the feature on if it is currently off.
4. When the seatbelt warning lamp is on, buckle then unbuckle the seatbelt. After Step 4, the seatbelt warning lamp flashes for confirmation.

CHILD RESTRAINT AND SEATBELT MAINTENANCE

Inspect the vehicle seatbelts and child safety seat systems periodically to make sure they work properly and are not damaged. Inspect the vehicle and child restraint seatbelts to make sure there are no nicks, tears or cuts. Replace if necessary. All vehicle seatbelt assemblies, including retractors, buckles, front seatbelt buckle assemblies, buckle support assemblies (slide bar-if equipped), shoulder belt height adjusters (if equipped), shoulder belt guide on seat backrest (if equipped), child safety seat LATCH and tether anchors, and attaching hardware, should be inspected after a crash. Read the child restraint manufacturer's instructions for additional inspection and maintenance information specific to the child restraint.

Seatbelts

We recommend that all seatbelt assemblies in use in vehicles involved in a crash be replaced. However, if the crash was minor and an authorized dealer finds that the belts do not show damage and continue to operate properly, they do not need to be replaced. Seatbelt assemblies not in use during a crash should also be inspected and replaced if either damage or improper operation is noted.

Properly care for seatbelts. See **Vehicle Care** (page 339).

If, because of body size or driving position, it is not possible to properly fasten the seatbelt over your lap and shoulder, an extension that is compatible with the seatbelts is available free of charge from our dealers. Only use our seatbelt extensions made by the original equipment seatbelt manufacturer with our seatbelts. Ask your authorized dealer if your extension is compatible with your vehicle restraint system.

SEATBELT EXTENSIONS



WARNING: Persons who fit into the vehicle's seatbelt should not use an extension. Unnecessary use could result in serious personal injury in the event of a crash.



WARNING: Only use extensions provided free of charge by our dealers. The dealer will provide an extension designed specifically for this vehicle, model year and seating position. The use of an extension intended for another vehicle, model year or seating position may not offer you the full protection of your vehicle's seatbelt restraint system.



WARNING: Never use seatbelt extensions to install child restraints.



WARNING: Do not use extensions to change the way the seatbelt fits across the torso, over the lap or to make the seatbelt buckle easier to reach.

Personal Safety System™

This system provides an improved overall level of frontal crash protection to front seat occupants and is designed to help further reduce the risk of airbag-related injuries. The system analyzes different occupant conditions and crash severity before activating the appropriate safety devices to help better protect occupants in a variety of frontal crash situations.

Your vehicle's Personal Safety System consists of:

- Driver and passenger dual-stage airbag supplemental restraints.
- Front seat outermost seatbelts with pretensioners, energy management retractors and seatbelt usage sensors.
- Front passenger sensing system.
- Passenger airbag off and on indicators.
- Front crash severity sensors.
- Restraints control module with impact and safing sensors.
- Restraint system warning light and tone.
- The electrical wiring for the airbags, crash sensors, seatbelt pretensioners, front seatbelt usage sensors, front passenger sensing system and indicator lights.

How Does the Personal Safety System Work?

The Personal Safety System can adapt the deployment strategy of the safety devices according to crash severity and occupant conditions. A collection of crash and occupant sensors provides information to the restraints control module. During a crash, the restraints control module may deploy the seatbelt pretensioners, one or both stages of the dual-stage airbags based on crash severity and occupant conditions.

Supplementary Restraints System

PRINCIPLE OF OPERATION

 **WARNING:** Airbags do not inflate slowly or gently, and the risk of injury from a deploying airbag is the greatest close to the trim covering the airbag module.

 **WARNING:** All occupants of your vehicle, including the driver, should always properly wear their seatbelts, even when an airbag supplemental restraint system is provided. Failure to properly wear your seatbelt could seriously increase the risk of injury or death.

 **WARNING:** Even with advanced restraints systems, properly restrain children 12 and under in a rear seating position. Failure to follow this could seriously increase the risk of injury or death.

 **WARNING:** Do not place your arms on the airbag cover or through the steering wheel. Failure to follow this instruction could result in personal injury.

 **WARNING:** Keep the areas in front of the airbags free from obstruction. Do not affix anything to or over the airbag covers. Objects could become projectiles during airbag deployment or in a sudden stop. Failure to follow this instruction could result in personal injury or death.

 **WARNING:** Airbags can kill or injure a child in a child restraint. Never place a rear-facing child restraint in front of an active airbag. If you must use a forward-facing child restraint in the front seat, move the seat upon which the child restraint is installed all the way back.

 **WARNING:** Do not attempt to service, repair, or modify the supplementary restraint system or associated components. Failure to follow this instruction could result in personal injury or death.

 **WARNING:** Several airbag system components get hot after inflation. To reduce the risk of injury, do not touch them after inflation.

 **WARNING:** If a supplementary restraint system component has deployed, it will not function again. Have the system and associated components inspected as soon as possible. Failure to follow this instruction could result in personal injury or death.

The airbags are a supplemental restraint system and are designed to work with the seatbelts to help protect the driver and right front passenger from certain upper body injuries. Airbags do not inflate slowly; there is a risk of injury from a deploying airbag.

Note: *You will hear a loud bang and see a cloud of harmless powdery residue if an airbag deploys. This is normal.*

The airbags inflate and deflate rapidly upon activation. After airbag deployment, it is normal to notice a smoke-like, powdery residue or smell the burnt propellant. This may consist of cornstarch, talcum powder (to lubricate the bag) or sodium compounds (for example, baking soda) that result from the combustion process that inflates the airbag. Small amounts of sodium hydroxide may be present which may irritate the skin and eyes, but none of the residue is toxic.

Supplementary Restraints System

While the system is designed to help reduce serious injuries, contact with a deploying airbag may also cause abrasions or swelling. Temporary hearing loss is also a possibility as a result of the noise associated with a deploying airbag. Because airbags must inflate rapidly and with considerable force, there is the risk of death or serious injuries such as fractures, facial and eye injuries or internal injuries, particularly to occupants who are not properly restrained or are otherwise out of position at the time of airbag deployment. Thus, it is extremely important that occupants be properly restrained as far away from the airbag module as possible while maintaining vehicle control.

Routine maintenance of the airbags is not required.

DRIVER AND PASSENGER AIRBAGS

 **WARNING:** Do not place your arms on the airbag cover or through the steering wheel. Failure to follow this instruction could result in personal injury.

 **WARNING:** Keep the areas in front of the airbags free from obstruction. Do not affix anything to or over the airbag covers. Objects could become projectiles during airbag deployment or in a sudden stop. Failure to follow this instruction could result in personal injury or death.

 **WARNING:** Airbags can kill or injure a child in a child restraint. Never place a rear-facing child restraint in front of an active airbag. If you must use a forward-facing child restraint in the front seat, move the seat upon which the child restraint is installed all the way back.

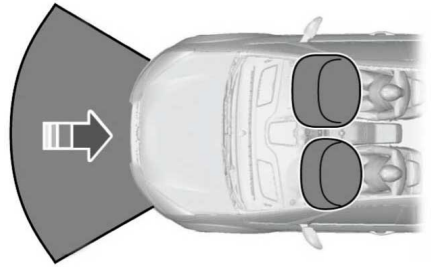

The driver and front passenger airbags will deploy during significant frontal and near frontal crashes.

The driver and passenger front airbag system consists of:

- Driver and passenger airbag modules.
- Front passenger sensing system.



• Crash sensors and monitoring system with readiness indicator. See **Crash Sensors and Airbag Indicator** (page 52).

Proper Driver and Front Passenger Seating Adjustment

 **WARNING:** National Highway Traffic Safety Administration (NHTSA) recommends a minimum distance of at least 10 in (25 cm) between an occupant's chest and the driver airbag module.

To properly position yourself away from the airbag:

- Move your seat to the rear as far as you can while still reaching the pedals comfortably.
- Recline the seat slightly (one or two degrees) from the upright position.

Supplementary Restraints System

After all occupants have adjusted their seats and put on seatbelts, it is very important that they continue to sit properly. A properly seated occupant sits upright, leaning against the seatback, and centered on the seat cushion, with their feet comfortably extended on the floor. Sitting improperly can increase the chance of injury in a crash event. For example, if an occupant slouches, lies down, turns sideways, sits forward, leans forward or sideways, or puts one or both feet up, the chance of injury during a crash is greatly increased.

Children and Airbags

WARNING: Airbags can kill or injure a child in a child restraint. Never place a rear-facing child restraint in front of an active airbag. If you must use a forward-facing child restraint in the front seat, move the seat upon which the child restraint is installed all the way back.



Children must always be properly restrained. Accident statistics suggest that children are safer when properly restrained in the rear seating positions than in the front seating position. Failure to follow these instructions may increase the risk of injury in a crash.

FRONT PASSENGER SENSING SYSTEM

WARNING: Even with advanced restraints systems, properly restrain children 12 and under in a rear seating position. Failure to follow this could seriously increase the risk of injury or death.

WARNING: Sitting improperly, out of position or with the seatback reclined too far can take weight off the seat cushion and affect the decision of the passenger sensing system, resulting in serious injury or death in the event of a crash. Always sit upright against your seat back, with your feet on the floor.

WARNING: Any alteration or modification to the front passenger seat may affect the performance of the front passenger sensing system. This could seriously increase the risk of injury or death.

This system works with sensors that are part of the front passenger seat and seatbelt to detect the presence of a properly-seated occupant and determine if the front passenger frontal airbag should be enabled (may inflate) or not.

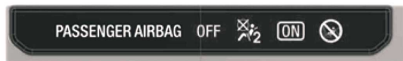

The front passenger sensing system uses a passenger airbag status indicator that illuminates indicating that the front passenger frontal airbag is either on (enabled) or off (disabled).

Supplementary Restraints System

The indicators are on the overhead console.

Note: *The indicators illuminate briefly when you first switch the ignition on to confirm they are functional.*

The front passenger sensing system is designed to disable (will not inflate) the front passenger frontal airbag when the front passenger seat is unoccupied, or a rear facing infant seat, a forward-facing child restraint, or a booster seat is detected. Even with this technology, parents are **strongly** encouraged to always properly restrain children in the rear seat.

- When the front passenger sensing system disables (will not inflate) the front passenger frontal airbag, the airbag off indicator illuminates and stays lit to remind you that the front passenger frontal airbag is disabled.
- If you have installed the child restraint and the airbag on indicator illuminates, switch the vehicle off, remove the child restraint from the vehicle and reinstall the restraint according to the child restraint manufacturer's instructions.

The front passenger sensing system is designed to enable (may inflate) the front passenger frontal airbag anytime the system senses that a person of adult size is sitting properly in the front passenger seat.

- When the front passenger sensing system enables the front passenger frontal airbag (may inflate), the airbag on indicator illuminates and remains illuminated.

If a person of adult size is sitting in the front passenger seat, but the airbag off indicator is lit, it is possible that the person is not sitting properly in the seat. If this happens:

- Switch the vehicle off and ask the person to place the seat backrest in an upright position.
- Have the person sit upright in the seat, centered on the seat cushion, with the person's legs comfortably extended.
- Restart the vehicle and have the person remain in this position for about two minutes. This allows the system to detect that person and enables the passenger frontal airbag.
- If the airbag off indicator remains lit even after this, advise the person to ride in the rear seat.

Occupant	Passenger Airbag Status Indicator	Passenger Airbag
Empty	OFF: Lit	Disabled
	ON: Unlit	
Child	OFF: Lit	Disabled
	ON: Unlit	
Adult	OFF: Unlit	Enabled
	ON: Lit	

Supplementary Restraints System

After all occupants have adjusted their seats and put on seatbelts, it is very important that they continue to sit properly. A properly seated occupant sits upright, leaning against the seat backrest, and centered on the seat cushion, with their feet comfortably extended on the floor. Sitting improperly can increase the chance of injury in a crash event. For example, if an occupant slouches, lies down, turns sideways, sits forward, leans forward or sideways, or puts one or both feet up, the chance of injury during a crash greatly increases.



Make sure the front passenger sensing system is operating properly. See **Crash Sensors and Airbag Indicator** (page 52).

Do not attempt to repair or service the system. Take your vehicle immediately to an authorized dealer.

If it is necessary to modify an advanced front airbag system to accommodate a person with disabilities, contact our Customer Relationship Center. See **Getting the Services You Need** (page 298).

SIDE AIRBAGS



WARNING: Do not place objects or mount equipment on or near the airbag cover, on the side of the front or rear seatbacks, or in areas that may come into contact with a deploying airbag. Failure to follow these instructions may increase the risk of personal injury in the event of a crash.



WARNING: Accessory seat covers not released by Ford Motor Company could prevent the deployment of the airbags and increase the risk of injuries in a crash.



WARNING: Do not lean your head on the door. The side airbag could injure you as it deploys from the side of the seatback.



WARNING: Do not attempt to service, repair, or modify the supplementary restraint system or associated components. Failure to follow this instruction could result in personal injury or death.



WARNING: If a supplementary restraint system component has deployed, it will not function again. Have the system and associated components inspected as soon as possible. Failure to follow this instruction could result in personal injury or death.

The side airbags are on the outermost side of the front seat backrests. In certain sideways crashes or rollover events, the side airbags will be inflated. The airbag was designed to inflate between the door panel and occupant to further enhance the protection provided to occupants in side impact crashes.



Supplementary Restraints System

The system consists of the following:

- A label or embossed side panel indicating that your vehicle has side airbags.
- Side airbags inside the driver and front passenger seat backrests.



Crash sensors and monitoring system with readiness indicator. See **Crash Sensors and Airbag**

Indicator (page 52).

The design and development of the side airbag system included recommended testing procedures that were developed by a group of automotive safety experts known as the Side Airbag Technical Working Group. These recommended testing procedures help reduce the risk of injuries related to the deployment of side airbags.

DRIVER AND PASSENGER KNEE AIRBAGS

Driver and passenger knee airbags are located under or within the instrument panel. During a crash, the restraints control module may activate the driver and passenger knee airbags (individually or both) based on crash severity and respective occupant conditions. Under certain crash and occupant conditions, the driver and passenger knee airbags may deploy (individually or both) but the corresponding front airbag may not activate. As with front and side airbags, it is important to be properly seated and restrained to reduce the risk of death or serious injury.



Make sure the knee airbags are operating properly. See **Crash Sensors and Airbag Indicator**

(page 52).

SAFETY CANOPY™



WARNING: Do not place objects or mount equipment on or near the headliner at the siderail that may come into contact with a deploying curtain airbag. Failure to follow these instructions may increase the risk of personal injury in the event of a crash.



WARNING: Do not lean your head on the door. The curtain airbag could injure you as it deploys from the headliner.



WARNING: Do not attempt to service, repair, or modify the supplementary restraint system or associated components. Failure to follow this instruction could result in personal injury or death.



WARNING: All occupants of your vehicle, including the driver, should always properly wear their seatbelts, even when an airbag supplemental restraint system is provided. Failure to properly wear your seatbelt could seriously increase the risk of injury or death.



WARNING: To reduce risk of injury, do not obstruct or place objects in the deployment path of the airbag.



WARNING: If a supplementary restraint system component has deployed, it will not function again. Have the system and associated components inspected as soon as possible. Failure to follow this instruction could result in personal injury or death.

Supplementary Restraints System

The Safety Canopy will deploy during significant side crashes or when a certain likelihood of a rollover event is detected by the rollover sensor. The Safety Canopy is mounted to the roof side-rail sheet metal, behind the headliner, above each row of seats. In certain sideways crashes or rollover events, the Safety Canopy will be activated, regardless of which seats are occupied. The Safety Canopy is designed to inflate between the side window area and occupants to further enhance protection provided in side impact crashes and rollover events.

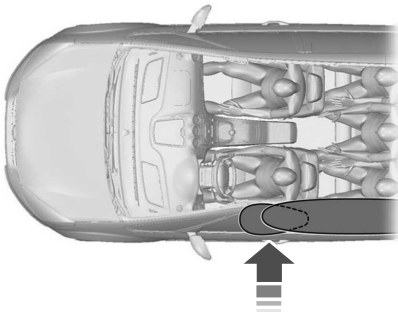

The system consists of the following:

- Safety canopy curtain airbags above the trim panels over the front and rear side windows identified by a label or wording on the headliner or roof-pillar trim.
- A flexible headliner which opens above the side doors to allow air curtain deployment



• Crash sensors and monitoring system with readiness indicator. See **Crash Sensors and Airbag Indicator** (page 52).

Always properly restrain children 12 years old and under in the rear seats. The Safety Canopy will not interfere with children restrained using a properly installed child or booster seat because it is designed to inflate downward from the headliner above the doors along the side window opening.

The design and development of the Safety Canopy included recommended testing procedures that were developed by a group of automotive safety experts known as the Side Airbag Technical Working Group. These recommended testing procedures help reduce the risk of injuries related to the deployment of side airbags (including the Safety Canopy).

CRASH SENSORS AND AIRBAG INDICATOR



WARNING: Modifying or adding equipment to the front of your vehicle could affect the performance of the airbag system, increasing the risk of injury. This includes the hood, bumper system, frame, front body structure, tow hooks, hood pins, push bar and snowplows.

Your vehicle has a collection of crash and occupant sensors which provide information to the restraints control module. The restraints control module deploys (activates) the seatbelt pretensioners, driver airbag, passenger airbag, knee airbag(s), seat mounted side airbags and the Safety Canopy. Based on the type of crash, the restraints control module deploys the appropriate safety devices.

Supplementary Restraints System

The restraints control module also monitors the readiness of the above safety devices plus the crash and occupant sensors. The readiness of the safety system is indicated by a warning indicator light in the instrument cluster or by a backup tone if the warning light is not working. Routine maintenance of the airbag is not required.

A difficulty with the system is indicated by one or more of the following:



- The readiness light will not illuminate immediately after you switch the ignition on.
- The readiness light either flashes or stays lit.
- A series of five beeps is heard. The tone pattern repeats periodically until the problem, the light or both are repaired.

If any of these things happen, even intermittently, have the supplemental restraint system serviced at an authorized dealer immediately. Unless serviced, the system may not function properly in the event of a crash.

The restraint system is designed to activate when the vehicle sustains conditions sufficient to cause the restraint control module to deploy a safety device.

The fact that not all the safety devices activate for all occupants in a crash does not mean something is wrong with the system. Rather, it means the restraints control module determined the accident conditions (crash severity, type of crash, belt usage) were not appropriate to activate these safety devices.

- The front airbags are designed to activate only in frontal and near-frontal crashes (not rollovers, side impacts or rear impacts) unless the crash causes sufficient frontal deceleration.
- The seatbelt pretensioners are designed to activate in frontal, near-frontal and side crashes, and in rollovers.
- The knee airbag(s) may deploy based on crash severity and occupant conditions.
- The side airbags are designed to inflate in certain side impact crashes or rollover events. Side airbags may activate in other types of crashes if your vehicle experiences sufficient sideways motion or deformation, or a certain likelihood of rollover.
- The Safety Canopy is designed to inflate in certain side impact crashes or rollover events. The Safety Canopy may activate in other types of crashes if your vehicle experiences sufficient sideways motion or deformation, or a certain likelihood of rollover.

AIRBAG DISPOSAL

Contact your authorized dealer as soon as possible. Airbags must be disposed of by qualified personnel.

Pedestrian Protection - Hybrid Electric Vehicle (HEV)

PEDESTRIAN ALERT SYSTEM

Due to the quiet operation of hybrid and electric vehicles at low speeds, the system creates a subtle sound to alert pedestrians.

The system is on when your vehicle is running and not in park (P). Some sound may be audible in the passenger compartment.

911 Assist

WHAT IS 911 ASSIST

911 Assist is a SYNC system feature that can call for help.

For more information, visit www.owner.ford.com.

HOW DOES 911 ASSIST WORK

If a crash deploys an airbag, excluding knee airbags and rear inflatable seatbelts, or activates the fuel pump shut-off, your vehicle may be able to contact emergency services by dialing 911 through a paired and connected **Bluetooth**® enabled phone.

Not all crashes deploy an airbag or activate the fuel pump shut-off. If a connected cell phone sustains damage or loses its connection to SYNC during a crash, SYNC searches for and tries to connect to a previously paired cell phone. SYNC then attempts to call the emergency services.

Before making the call:

- SYNC provides about 10 seconds to cancel the call. If you fail to cancel the call, SYNC attempts to dial 911.
- SYNC says the following, or a similar message: SYNC will attempt to call 911, to cancel the call, press Cancel on your screen or press and hold the phone button on your steering wheel.

If you do not cancel the call and SYNC makes a successful call a pre-recorded message plays for the 911 operator. The occupants in your vehicle are able to talk with the operator. Be prepared to provide your name, phone number and location immediately because not all 911 systems are capable of receiving this information electronically.

During an emergency call the system transmits vehicle data to the emergency service.

EMERGENCY CALL REQUIREMENTS



WARNING: Do not wait for 911 Assist to make an emergency call if you can do it yourself. Dial emergency services immediately to avoid delayed response time which could increase the risk of serious injury or death after a crash. If you do not hear 911 Assist within five seconds of the crash, the system or phone may be damaged or non-functional.



WARNING: Always place your phone in a secure location in your vehicle so it does not become a projectile or get damaged in a crash. Failure to do so may cause serious injury to someone or damage the phone which could prevent 911 Assist from working properly.



WARNING: Unless the 911 Assist setting is set on before a crash, the system will not dial for help which could delay response time, potentially increasing the risk of serious injury or death after a crash.

- SYNC must be powered and working properly at the time of the incident and throughout feature activation and use.
- The 911 Assist feature must be set on before the incident.
- You must pair and connect a **Bluetooth**® enabled and compatible cell phone to SYNC.
- A connected **Bluetooth**® enabled phone must have the ability to make and maintain an outgoing call at the time of the incident.

911 Assist

- A connected **Bluetooth**® enabled phone must have adequate network coverage, battery power and signal strength.
- The vehicle must have battery power and be located in the U.S., Canada or in a territory in which 911 is the emergency number.

Note: *If any user sets 911 Assist to on or off, that setting applies for all paired phones. If 911 Assist is switched off and the phone is connected to SYNC, an icon displays on the status bar.*

Note: *Every phone operates differently. While SYNC 911 Assist works with most cellular phones, some may have trouble using this feature.*

EMERGENCY CALL LIMITATIONS

The SYNC 911 Assist feature only operates in the U.S., Canada or in a territory in which 911 is the emergency number.

- Your cellular phone or 911 Assist hardware sustains damage in a crash.
- The vehicle's battery or the SYNC system has no power.
- The phone(s) thrown from your vehicle are the ones paired and connected to the system.

Keys and Remote Controls

GENERAL INFORMATION ON RADIO FREQUENCIES

This device complies with Part 15 of the FCC Rules and with Industry Canada license-exempt RSS standard(s). Operation is subject to the following two conditions: (1) This device may not cause harmful interference, and (2) This device must accept any interference received, including interference that may cause undesired operation.



WARNING: Changes or modifications not expressly approved by the party responsible for compliance could void the user's authority to operate the equipment. The term "IC:" before the radio certification number only signifies that Industry Canada technical specifications were met.

The typical operating range for your transmitter is approximately 33 ft (10 m). Vehicles with the remote start feature will have a greater range.

One of the following could cause a decrease in operating range:

- Weather conditions.
- Nearby radio towers.
- Structures around the vehicle.
- Other vehicles parked next to your vehicle.

The radio frequency used by your remote control can also be used by other radio transmitters, for example amateur radios, medical equipment, wireless headphones, wireless remote controls, cell phones, battery chargers and alarm systems. If the frequencies are jammed, you will not be able to use your remote control. You can lock and unlock the doors with the key.

Note: Make sure to lock your vehicle before leaving it unattended.

Note: If you are in range, the remote control will operate if you press any button unintentionally.

Note: The remote control contains sensitive electrical components. Exposure to moisture or impact may cause permanent damage.

Intelligent Access (If Equipped)

The system uses a radio frequency signal to communicate with your vehicle and authorize your vehicle to unlock when one of the following conditions are met:

- You activate the front exterior door handle switch.
- You press the luggage compartment button.
- You press a button on the transmitter.

If excessive radio frequency interference is present in the area or if the transmitter battery is low, you may need to mechanically unlock your door. You can use the mechanical key blade in your intelligent access key to open the driver door in this situation. See **Remote Control** (page 57).

REMOTE CONTROL

Integrated Keyhead Transmitter

Use the key blade to start your vehicle and unlock or lock the driver door from outside your vehicle. The integrated keyhead transmitter functions as a programmed ignition key that operates all the locks and starts your vehicle, as well as a remote control.

Keys and Remote Controls



E151797

Press the button to release the key blade. Press and hold the button to fold the key blade back in when not in use.



Note: Your vehicle keys came with a security label that provides important key cut information. Keep the label in a safe place for future reference.

Intelligent Access Key (if Equipped)



Your remote control operates the power locks and the remote start system. The key must be in your vehicle to use the push button start.

Note: You may not be able to shift out of park (P) unless the intelligent access key is inside your vehicle.

Removable Key Blade

Your remote control also contains a removable key blade that you can use to unlock your vehicle.

Keys and Remote Controls



Press the release button and pull the key blade out.



Note: Your vehicle keys came with a security label that provides important key cut information. Keep the label in a safe place for future reference.

Replacing the Battery

WARNING: Keep batteries away from children to prevent ingestion. Failure to follow this instruction could result in personal injury or death. If ingested, immediately seek medical attention.

WARNING: If the battery compartment does not securely close, stop using the remote control and replace it as soon as possible. In the meantime, keep the remote control away from children. Failure to follow this instruction could result in personal injury or death.

A message appears in the information display when the remote control battery is low. See **Information Messages** (page 119).

Note: Refer to local regulations when disposing of transmitter batteries.

Note: Do not wipe off any grease on the battery terminals or on the back surface of the circuit board.

Note: Replacing the battery does not erase the programmed key from your vehicle. Your remote control should operate normally.

Integrated Keyhead Transmitter

The remote control uses one coin-type three-volt lithium battery.

Press the button to release the key blade before beginning the procedure.



E151798

1. Insert a suitable tool, for example a screwdriver, in the position shown and gently push the clip.

Keys and Remote Controls

2. Press the clip down to release the battery cover.

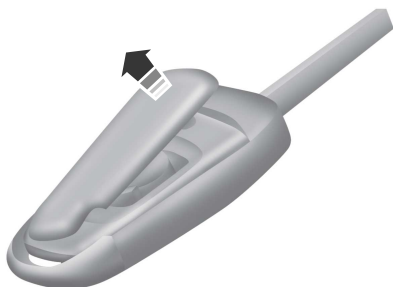

3. Carefully remove the cover.

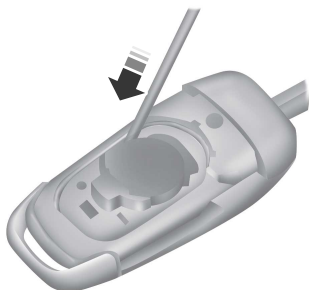

Note: Do not touch the battery contacts or the printed circuit board with the screwdriver.

4. Insert the screwdriver as shown to release the battery.

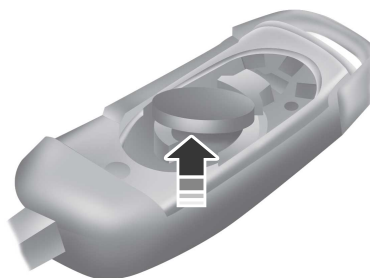

5. Remove the battery.
6. Install a new battery with the + facing upward.
7. Reinstall the battery cover.

Intelligent Access Key

The remote control uses one coin-type three-volt lithium battery.



1. Push the release button and pull the key blade out.

Keys and Remote Controls

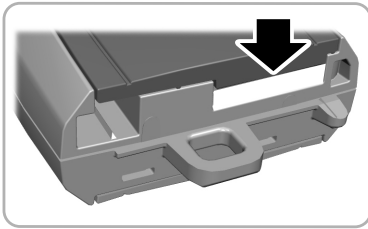

2. Twist a thin coin under the tab hidden behind the key blade head to remove the battery cover.

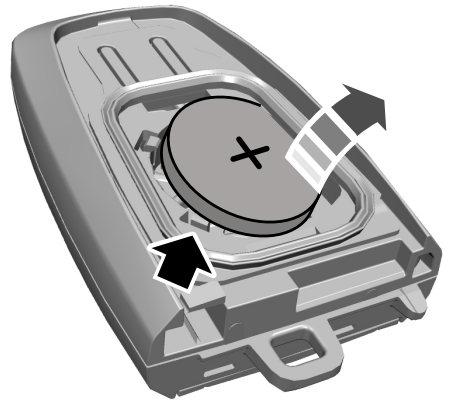

3. Insert a suitable tool, for example a screwdriver, in the position shown and carefully remove the battery.
4. Install a new battery with the + facing up.
5. Reinstall the battery housing cover onto the transmitter and install the key blade.

Memory Feature (If Equipped)

You can use the remote control to recall memory positions.

If programmed to a pre-set position, the remote control recalls memory positions when you unlock your vehicle. If you have the easy entry and exit feature enabled and the ignition is off, the seat moves to the easy entry position. The seat moves to the driver memory position when you switch the ignition on.

Linking a Preset Position to Your Remote Control or Intelligent Access Key

See **Memory Function** (page 150).

Keys and Remote Controls

Car Finder



Press the button twice within three seconds. The horn sounds and the direction indicators flash. We recommend you use this method to locate your vehicle, rather than using the panic alarm.

Sounding the Panic Alarm



Press the button to sound the panic alarm. Press the button again or switch the ignition on to turn it off.

Note: *The panic alarm only operates when the ignition is off.*

Remote Start (If Equipped)



WARNING: Do not start the engine in a closed garage or in other enclosed areas. Exhaust fumes are toxic. Always open the garage door before you start the engine. Failure to follow this instruction could result in personal injury or death.



The remote start button is on the remote control.

This feature allows you to start your vehicle from the outside. Your remote control has an extended operating range.

If your vehicle has automatic climate control, you can configure it to operate when you remote start your vehicle. See **Climate Control** (page 137). A manual climate control system runs at the setting it was set to when you switched your vehicle off.

Many states and provinces have restrictions for the use of remote start.

Check your local and state or provincial laws for specific requirements regarding remote start systems.

The system does not work if:

- The ignition is on.
- The anti-theft alarm triggers.
- You disable the feature.
- The hood is open.
- The transmission is not in park (P).
- The battery voltage is below the minimum operating voltage.
- The service engine soon light is on.

Note: *Do not use remote start if your fuel level is low.*

Remote Control Feedback (If Equipped)

An LED on the remote control provides status feedback of remote start or stop commands.

LED	Status
Solid green	Remote start successful
Solid red	Remote stop successful
Blinking red	Request failed or status not received
Blinking green	Status incomplete

Remote Starting Your Vehicle

Note: *You must press each button within three seconds of each other. If you do not follow this sequence, your vehicle does not start remotely, the direction indicators do not flash twice and the horn does not sound.*

Keys and Remote Controls

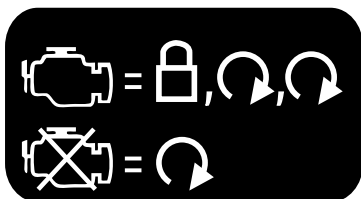

E138626

To remote start your vehicle:

1. Press the lock button to lock all the doors.
2. Press the remote start button twice. The exterior lamps flash twice.

The horn sounds if the system fails to start, unless quiet start is on. Quiet start runs the blower fan at a slower speed to reduce noise. You can switch it on or off in the information display.

Note: *If you have remote started your vehicle with an integrated keyhead transmitter, you must switch on the ignition before driving your vehicle. With an intelligent access transmitter, you must press the brake pedal before driving your vehicle.*

The power windows do not work during remote start and the radio does not turn on automatically.

The parking lamps remain on and your vehicle runs for 5, 10 or 15 minutes, depending on the setting.

Extending the Engine Running Time

Repeat Steps 1 and 2 with the vehicle still running to extend the run time for another remote start period. If you have the duration set to 15 minutes, the duration extends by another 15 minutes. For example, if the vehicle has run from the first remote start for five minutes, the vehicle continues to run now for a total of 30 minutes. You can extend the remote start up to a maximum of 35 minutes.

Wait at least five seconds before remote starting after the engine stops running.

Turning Your Vehicle Off After Remote Starting



Press the button once. Your vehicle and the parking lamps turn off.

You may have to be closer to your vehicle than when starting due to ground reflection and the added noise of your running vehicle.

You can switch this feature on or off in the information display.

REPLACING A LOST KEY OR REMOTE CONTROL

Replacement keys or remote controls can be purchased from an authorized dealer. Authorized dealers can program remote controls for your vehicle.

PRINCIPLE OF OPERATION

MyKey allows you to program keys with restricted driving modes to promote good driving habits. You can program the restrictions to all keys except one. Any keys that you did not program are administrator keys or admin keys.

You can use admin keys to:

- Create a MyKey with certain vehicle restrictions.
- Program certain MyKey settings.
- Clear all MyKey restrictions.

After you program a MyKey, you can view the following information through the information display:

- The total number of admin keys and MyKeys for your vehicle.
- The total distance a MyKey driver traveled with your vehicle.

Note: Every MyKey receives the same restrictions and settings. You cannot program them individually.

Note: For vehicles equipped with a push-button start switch: When both a MyKey and an admin key are present when you start your vehicle, the system recognizes the admin key only.

Standard Settings

Not every vehicle includes the features listed below. If your vehicle has this equipment, then you cannot change the following settings when using a MyKey:

- Seatbelt reminder or Belt-Minder™. MyKey mutes the audio system until drivers, and in some instances, passengers, fasten their seatbelts. **Note:** If your vehicle includes an AM/FM radio or a very basic audio system, then the radio may not mute.
- Earlier low-fuel warning. The low-fuel warning activates earlier for MyKey drivers, giving them more time to refuel.
- Certain driver alerts, stability systems or parking aids turn on automatically when you use the MyKey system. For example, Blind Spot Information System (BLIS), cross traffic alert, lane departure warning or forward collision warning. **Note:** MyKey drivers may be able to turn the lane departure warning feature off, but this feature turns back on automatically with every new key cycle.
- Restricted touchscreen operation in some markets. For example, MyKey may prevent manual navigation destination input while the vehicle is in any gear other than park (P) or when the vehicle reaches a certain rate of speed.
- Satellite radio adult content restrictions, if this feature is available in your market.

Optional Settings

You can configure certain vehicle feature settings when you first create a MyKey. You can also change the settings afterward with an admin key.

Note: *Not every feature applies to every vehicle in every market. When they are available for your vehicle, then they appear in the information display, providing choices to switch them on or off, or to select a more specific setting.*

- Various vehicle speed limits so the MyKey driver cannot exceed certain speeds. The information display shows warnings followed by an audible tone when the MyKey driver reaches the set speed. You cannot override the set speed by fully depressing the accelerator pedal.



WARNING: Do not set MyKey maximum speed limit to a limit that will prevent the driver from maintaining a safe speed considering posted speed limits and prevailing road conditions. The driver is always responsible to drive in accordance with local laws and prevailing conditions. Failure to do so could result in accident or injury.

- Various vehicle speed reminders so MyKey drivers know when their vehicle speed approaches the limits. Warnings appear in the information display and a tone sounds when the MyKey drivers exceed the set vehicle speed.
- The audio system's maximum volume limits to 45% so MyKey drivers can concentrate on the road. A message appears in the information display when MyKey drivers attempt to exceed the limited volume. MyKey also disables the automatic volume control. **Note:** If your vehicle includes an AM/FM radio or a very basic audio system, then the radio may not limit.
- Always on setting. This setting forces certain features to remain on and active for MyKey drivers. For example, E911 or emergency assistance and the do not disturb features stay on even if a MyKey driver uses the feature's control to switch it off. When selected, you will not be able to turn off Advance Trac or traction control (if your vehicle has this feature).

CREATING A MYKEY

Use the touchscreen to create a MyKey:

1. Insert the key you want to program into the ignition. If your vehicle has a push button start, place the remote control into the backup slot. See **Starting a Gasoline Engine** (page 169).
2. Switch the ignition on.
3. Press **SETTINGS**.
4. Press **Vehicle**.
5. Press **MyKey**.
6. Press **Create MyKey**.
7. Press **Yes**.
8. Switch the ignition off.

You have successfully created a MyKey. Make sure you label it so you can distinguish it from the admin keys.

You can also program configurable settings for the key.

Programming and Changing Configurable Settings

Use the touchscreen to access your configurable MyKey settings.

1. Switch the ignition on using an admin key or the remote control you want to program.
2. Press **SETTINGS**.
3. Press **Vehicle**.
4. Press **MyKey**.
5. Select a setting and configure it by following the instructions on the touchscreen.

The programmed restrictions apply when you switch the vehicle off, open and close the driver door and restart your vehicle with the programmed key or remote control.

Note: *You can clear or change your MyKey settings at any time during the same key cycle as you created the MyKey. Once you have switched the vehicle off, you need an admin key to change or clear your MyKey settings. When you make any changes to your MyKey settings, you change the settings for every MyKey. You cannot make individual changes to apply to specific MyKeys.*

CLEARING ALL MYKEYS

When you clear your MyKeys, you remove all restrictions and return all MyKeys to their original admin key status at once. To clear all MyKeys of all MyKey settings, use the touchscreen.

1. Switch the ignition on using an admin key.

2. Press **SETTINGS**.
3. Press **Vehicle**.
4. Press **MyKey**.
5. Press **Clear All MyKeys**.
6. Press **Yes**.
7. A confirmation message appears in the display after you finish clearing your MyKeys.

CHECKING MYKEY SYSTEM STATUS

You can find information about your programmed MyKeys by using the touchscreen. See **Settings** (page 458).

MyKey Distance

Tracks the distance when drivers use a MyKey. The only way to delete the accumulated distance is by using an admin key to clear all MyKeys. If the distance does not accumulate as expected, then the intended user is not using the MyKey, or an admin key user recently cleared and then recreated a MyKey.

Number of MyKeys

Indicates the number of MyKeys you have programmed to your vehicle. Use this feature to detect how many MyKeys you have for your vehicle and determine when you have deleted all MyKeys.

Number of Admin Keys

Indicates how many admin keys you have programmed to your vehicle. Use this feature to determine how many admin keys you have for your vehicle, and detect if an additional MyKey has been programmed.

USING MYKEY WITH REMOTE START SYSTEMS

MyKey is not compatible with non

Ford-approved, aftermarket remote start systems. If you choose to install a remote start system, see an authorized dealer for a Ford-approved remote start system.

MYKEY – TROUBLESHOOTING

Condition	Potential Causes
I cannot create a MyKey.	The key or transmitter used to start the vehicle does not have admin privileges. Vehicles with keyless start: Make sure you place the transmitter into the backup slot. See Passive Anti-Theft System (page 77). The key or transmitter used to start the vehicle is the only admin key. There always has to be at least one admin key. The passive anti-theft system is disabled or in unlimited mode.
I cannot program the configurable settings.	The transmitter used to start your vehicle does not have admin privileges. There are no MyKeys programmed to the vehicle. See Creating a MyKey (page 65).
I cannot clear the MyKeys.	The key or transmitter used to start the vehicle does not have admin privileges. No MyKeys are created. See Creating a MyKey (page 65).
I lost the only admin key.	Purchase a new key or transmitter from an authorized dealer.
I lost a key.	Program a spare key or transmitter. You may need to see an authorized dealer. See Passive Anti-Theft System (page 77).
The MyKey distance does not accumulate.	The MyKey user is not using the MyKey. An admin key holder cleared the MyKeys and created new MyKeys. The key system has been reset.
No MyKey functions with the transmitter.	An admin transmitter is present at vehicle start. There are no MyKeys programmed to your vehicle. See Creating a MyKey (page 65).

Doors and Locks

LOCKING AND UNLOCKING

You can use the power door lock control or the remote control to lock and unlock your vehicle.

Note: Do not use the door latch assembly to attach any accessory, such as handles or steps, as this can cause damage to your vehicle.

Power Door Locks

The power door lock control is on the driver and front passenger door panels.

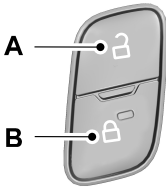

- A Unlock.
- B Lock.

Remote Control

You can use the remote control at any time.

Unlocking the Doors



Press the button to unlock the driver door.

Press the button again within three seconds to unlock all doors. The direction indicators flash.

Press and hold both the lock and unlock buttons on the remote control for three seconds to change between driver door or all doors unlock mode. The direction indicators flash twice to indicate a change to the unlocking mode. Driver door mode

only unlocks the driver door when you press the unlock button once. All door mode unlocks all doors when you press the unlock button once. The unlocking mode applies to the remote control, keyless entry keypad and intelligent access.

Locking the Doors



Press the button to lock all doors. The direction indicators flash.

Press the button again within three seconds to confirm that all the doors close. The doors lock again, the horn sounds and the direction indicators flash if all the doors and the liftgate close.

Mislock

If any door or the liftgate is open, or if the hood is open on vehicles with an anti-theft alarm or remote start, the horn sounds twice and the direction indicators do not flash.

Switching Mislock On and Off

1. Press **Settings** on the touchscreen.
2. Press **Vehicle Settings**.
3. Switch **Mislock Chirp** on or off.

Opening the Power Liftgate



Press the button twice within three seconds.

Opening a Rear Door from the Inside

Pull the interior door handle twice to unlock and open a rear door. The first pull unlocks the door and the second pull opens the door.

Doors and Locks

Note: The rear doors do not open using the interior door handles if your vehicle has the rear door lock disable feature, or with the child locks enabled.

Locking and Unlocking the Doors with the Key Blade

Locking with the Key

Turn the top of the key toward the front of your vehicle.

Unlocking with the Key

Turn the top of the key toward the rear of your vehicle.

Note: If the child safety locks are on and you pull the interior handle, you only turn off the emergency locking, not the child safety lock. You can only open the doors using the external door handle.

Activating Intelligent Access (If Equipped)

You can unlock and lock the vehicle without taking the keys out of your pocket or purse when your intelligent access key is within 3 ft (1 m) of your vehicle. Intelligent access uses a sensor on the back of the door handle for unlocking and a separate sensor on the face of each door handle for locking.

The system does not function if:

- Your vehicle battery has no charge.
- The key battery has no charge.
- The key frequencies jam.

Note: The system may not function if the key is close to metal objects or electronic devices, for example keys or a cell phone.

Note: If the system does not function, use the key blade to lock and unlock your vehicle. See **Remote Control** (page 57).

Unlocking Using Intelligent Access

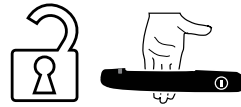

With your intelligent access key within 3 ft (1 m) of your vehicle, touch the unlock sensor on the back of the door handle for a brief period and then pull on the door handle to unlock, being careful to not touch the lock sensor at the same time or pulling the door handle too quickly. The intelligent access system requires a brief delay to authenticate your intelligent access key fob.

Locking Using Intelligent Access



With your intelligent access key within 3 ft (1 m) of your vehicle, touch the outer door handle lock sensor for approximately one second to lock, being careful to not touch the unlock sensor on the back of the door handle at the same time. After locking, you can immediately pull on the door handle to confirm locking occurred without inadvertently unlocking.

Opening the Liftgate

Press the exterior liftgate release button on the top of the liftgate pull-cup handle. See **Power Liftgate** (page 73).

Smart Unlocks for Integrated Keyhead Remote Control (If Equipped)

This prevents you from locking yourself out of your vehicle if the key is still in the ignition.

Doors and Locks

When you open one of the front doors and lock your vehicle with the power door lock control, all the doors lock then unlock and the horn sounds twice if the key is still in the ignition.

You can still lock your vehicle with the key in the ignition by either:

- Using the keyless entry keypad with the driver door closed.
- Pressing the lock button on the remote control even if you have not closed the doors.

If both front doors close, you can lock your vehicle by any method, regardless of whether the key is in the ignition or not.

Smart Unlocks for Intelligent Access Keys (If Equipped)

This helps to prevent you from locking your key inside the passenger compartment or rear cargo area.

When you electronically lock your vehicle with any door open, the transmission in park (P) and the ignition off, the system searches for an intelligent access key in the passenger compartment after you close the last door.

If the system finds a key, all the doors immediately unlock and the horn sounds twice, indicating that a key is inside.

You can override the smart unlock feature and intentionally lock the intelligent access key inside your vehicle.

To override smart unlock, lock your vehicle after you have closed all the doors by:

- Using the keyless entry keypad.
- Pressing the lock button on another intelligent access key.
- Touching the locking area on the front of the door handle with another intelligent access key in your hand.

When you open one of the front doors and lock your vehicle using the power door lock control, all doors lock, then unlock if:

- The ignition is on.
- The ignition is off and the transmission is not in park (P).

Autolock (If Equipped)

Autolock locks all the doors when the following occur:

- All doors close.
- The ignition is on.
- You shift into any gear putting your vehicle in motion.
- Your vehicle reaches a speed greater than 12 mph (20 km/h).

Autolock repeats when:

- You open then close any door when the ignition is on and your vehicle speed is 9 mph (15 km/h) or lower.
- Your vehicle reaches a speed greater than 12 mph (20 km/h).

Autounlock

Autounlock unlocks all the doors when the following occur:

- You stop your vehicle, place the gear selector in park (P), and switch the ignition off or to accessory position.
- You open the driver door within 10 minutes of switching the ignition off or to accessory position.

Note: *The doors do not autounlock if you electronically lock your vehicle after you switch the ignition off and before you open the driver door.*

Enabling or Disabling Autounlock

You can enable or disable the autounlock in the information display or an authorized dealer can do it for you. See **General Information** (page 115).

Doors and Locks

Illuminated Entry

The interior lamps and some exterior lamps illuminate when you unlock the doors with the remote control.

The lamps turn off if:

- The ignition is on.
- You press the remote control lock button.
- More than 25 seconds have elapsed.

The lamps do not turn off if:

- You switch them on with the lighting control.
- Any door is open.

Illuminated Exit

The interior lamps and some exterior lamps illuminate when all doors close and you switch the ignition off.

The lamps turn off if all the doors remain closed and:

- More than 25 seconds have elapsed.
- You lock your vehicle from the outside.

Battery Saver

If you leave the courtesy lamps, interior lamps or headlamps on, the battery saver shuts them off 10 minutes after you switch the ignition off.

Battery Saver for Intelligent Access Keys (If Equipped)

If you leave the ignition switched on and the engine is not running, the battery saver turns the ignition off when it detects a certain amount of battery drain, or after 30 minutes have elapsed.

KEYLESS ENTRY (IF EQUIPPED)

SECURICODE™ Keyless Entry Keypad

The keypad is near the driver window. It illuminates when touched.

Note: *If you enter your entry code too fast on the keypad, the unlock function may not work. Enter your entry code again more slowly.*

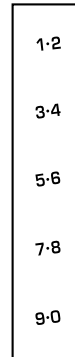

You can use the keypad to do the following:

- Lock or unlock the doors.
- Program and erase user codes.
- Arm and disarm the anti-theft alarm.

You can operate the keypad with the factory-set five-digit entry code. The code is on the owner's wallet card in the glove box and is available from an authorized dealer. You can also program up to five of your own five-digit personal entry codes.

Programming a Personal Entry Code

1. Enter the factory-set five-digit code.

Doors and Locks

2. Press **1-2** on the keypad within five seconds.
3. Enter your personal five-digit code. You must enter each number within five seconds of each other.
4. Press **1-2** on the keypad to save personal code 1.

The doors lock then unlock to confirm that programming was successful.

To program additional personal entry codes, repeat steps 1 through 3, then for step 4:

- Press **3-4** to save personal code 2.
- Press **5-6** to save personal code 3.
- Press **7-8** to save personal code 4.
- Press **9-0** to save personal code 5.

Hints:

- Do not set a code that uses five of the same number.
- Do not use five numbers in sequential order.
- The factory-set code works even if you have set your own personal code.

Erasing a Personal Code

1. Enter the factory-set five-digit code.
2. Press and release **1-2** on the keypad within five seconds.
3. Press and hold **1-2** for two seconds. You must do this within five seconds of completing step 2.

All personal codes erase and only the factory-set five-digit code works.

Anti-Scan Feature

The keypad goes into an anti-scan mode if you enter the wrong code seven times. This mode turns off the keypad for one minute and the keypad lamp flashes.

The anti-scan feature turns off after any of the following occur:

- One minute of keypad inactivity.
- You press the unlock button on the remote control.
- You switch your vehicle on.
- You unlock the vehicle using intelligent access.

Locking and Unlocking the Doors

Locking All Doors

Press and hold **7-8** and **9-0** on the keypad simultaneously with the driver door closed. You do not need to enter a code first.

Unlocking All Doors

Enter the factory-set code or your personal code, then press **3-4** on the keypad within five seconds.

Unlocking Only the Driver Door

Enter the factory-set or your personal five-digit code. You must press each number within five seconds of each other. The interior lamps illuminate.

Note: All doors unlock if the two-stage unlocking feature is turned off. See **Locking and Unlocking** (page 68).

Liftgate

POWER LIFTGATE



WARNING: It is extremely dangerous to ride in a cargo area, inside or outside of a vehicle. In a crash, people riding in these areas are more likely to be seriously injured or killed. Do not allow people to ride in any area of your vehicle that is not equipped with seats and seatbelts. Make sure everyone in your vehicle is in a seat and properly using a seatbelt. Failure to follow this warning could result in serious personal injury or death.



WARNING: Make sure that you fully close the liftgate to prevent exhaust fumes from entering your vehicle. If you are unable to fully close the liftgate, open the air vents or the windows to allow fresh air to enter your vehicle. Failure to follow this instruction could result in personal injury or death.



WARNING: Keep keys out of reach of children. Do not allow children to operate or play near an open or moving power liftgate. You should supervise the operation of the power liftgate at all times.

Note: Make sure that you close the liftgate before operating or moving your vehicle, especially in an enclosure, like a garage or a parking structure. This could damage the liftgate and its components.

Note: Do not hang anything, for example a bike rack, from the glass or liftgate. This could damage the liftgate and its components.

Note: Make sure that you fully close the liftgate to prevent cargo from falling out.

The liftgate only operates with the transmission in park (P).

If there is a problem with the open or close request, a tone sounds for one of the following reasons:

- The ignition is on and the transmission is not in park (P).
- The battery voltage is below the minimum operating voltage.
- The liftgate is not fully closed and your vehicle speed is at or above 3 mph (5 km/h).

If the liftgate starts to close after it has fully opened, this indicates there may be excessive weight on the liftgate or a possible strut failure. A repetitive tone sounds and the liftgate closes under control. If the liftgate continues to close after opening, have the system checked by an authorized dealer. Remove any excessive weight from the liftgate.

Opening and Closing the Liftgate



WARNING: Make sure all persons are clear of the power liftgate area before using the power liftgate control.

Note: Make sure the area behind your vehicle is free from obstruction and that there is enough room for you to operate the liftgate. Objects too close to your vehicle, for example a wall, garage door or another vehicle may come into contact with the moving liftgate. This could damage the liftgate and its components.

Note: Be careful when opening or closing the liftgate in a garage or other enclosed area to avoid damaging the liftgate.

Note: Do not leave the liftgate open when you are driving. This could damage the liftgate and its components.

Liftgate

Opening from the Instrument Panel



With the transmission in park (P), press the button on the instrument panel.

Opening with the Remote Control



Press the button twice within three seconds.

Opening with the Outside Control Button

1. Unlock the liftgate with the remote control or power door unlock control. If a passive key is within 3 ft (1 m) of the liftgate, the liftgate unlocks when you press the liftgate release button.



2. Press the control button to the right of the rear view camera.

Note: Allow the power system to open the liftgate. Manually pushing or pulling the liftgate may activate the system's obstacle detection feature and stop the power operation or reverse its direction, replicate a strut failure, or damage mechanical components.

Closing the Liftgate



WARNING: Keep clear of the liftgate when using the rear switch.

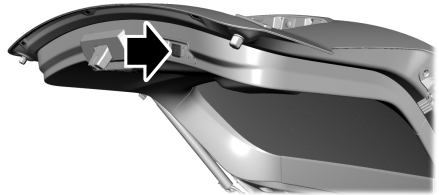

E291351

Press and release the liftgate button.

Stopping the Liftgate Movement

Note: Do not apply sudden excessive force to the liftgate while it is in motion. This could damage the power liftgate and its components.

You can stop the liftgate movement by doing any of the following:

- Pressing the liftgate control button.
- Pressing the liftgate button on the remote control twice.
- Pressing the liftgate button on the instrument panel.
- Moving your foot under and away from the center rear bumper in a single-kick motion.*

Liftgate

*This method only works for vehicles with the hands-free liftgate feature.

Setting the Liftgate Open Height

1. Open the liftgate.
2. Stop the liftgate movement by pressing the control button on the liftgate when it reaches the desired height.

Note: *Once the liftgate has stopped moving, you can also manually move it to the desired height.*

3. Press and hold the liftgate control button on the liftgate until you hear a tone, indicating programming is complete.

Note: *You can only use the liftgate control button to program the height.*

Note: *You cannot program the height if the liftgate position is too low.*

The new open liftgate height is recalled when the power liftgate is opened. To change the programmed height, repeat the above procedure. Once you open the power liftgate, you can manually move it to a different height.

Note: *The system recalls the new programmed height until you reprogram it, even if you disconnect the battery.*

When operating the power liftgate after you have programmed a lower height than fully open, you can fully open the liftgate by manually pushing it upward to the maximum open position.

Obstacle Detection

Note: *Entering your vehicle while the liftgate is closing can cause your vehicle to bounce and activate obstacle detection. To prevent this, let the power liftgate close completely before you enter your vehicle. Before driving off, check the instrument cluster for a liftgate or door ajar message or warning indicator. Failure to do this could result in unintentionally leaving the liftgate open while driving.*

When Closing

The system stops when it detects an obstacle. A tone sounds and the system reverses to open. Once you remove the obstacle, you can power close the liftgate.

When Opening

The system stops when it detects an obstacle and a tone sounds. Once you remove the obstacle, you can continue to operate the liftgate.

Switching the Power Liftgate On or Off

You can switch the power liftgate on or off through the vehicle settings on your touchscreen.

When switched off, the liftgate only unlatches and will not power open or close.

Hands-Free Feature (If Equipped)

Make sure you have the passive key within 3 ft (1 m) of the liftgate.

1. Stand behind your vehicle, and face the liftgate.
2. Move your foot, in a single-kick motion, without pausing, under and away from the rear bumper detection area.

Liftgate

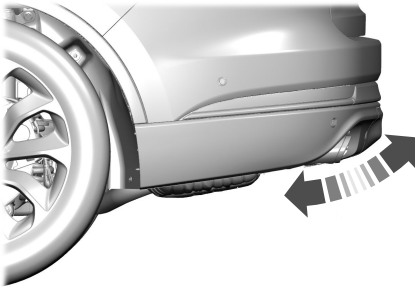

Vehicles With a Trailer Hitch

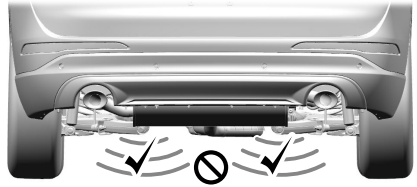

3. The liftgate opens or closes.

Avoid the following actions when using the hands-free opening feature:

- Making physical contact with the bumper.
- Holding your foot under the bumper.
- Sweeping your foot from side to side, or kicking at an odd angle.

Detection Zones

Vehicles Without a Trailer Hitch

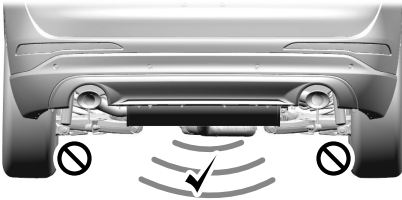

The detection area is in the center of the rear bumper.

The detection area is on the left-hand side and right-hand side of the hitch, between the exhaust and the hitch.

Note: Allow the power system to open the liftgate. Manually pushing or pulling the liftgate may activate the system's obstacle detection feature and stop the power operation or reverse its direction, replicate a strut failure, or damage mechanical components.

Note: Any physical actions that mimic a kicking motion such as splashing water, trailer chains or vacuum hoses may cause the hands-free liftgate to activate. Switch the power liftgate off through your vehicle settings or keep the passive key away from the rear bumper detection area.

Security

PASSIVE ANTI-THEFT SYSTEM

Note: The system is not compatible with non-Ford aftermarket remote start systems. Use of these systems could result in vehicle starting problems and a loss of security protection.

Note: Metallic objects, electronic devices or a second coded key on the same key chain could cause vehicle starting problems if they are too close to the key when starting the engine. Prevent these objects from touching the coded key while starting the engine. Switch the ignition off, move all objects on the key chain away from the coded key and restart the engine if a problem occurs.

Note: Do not leave a duplicate coded key in the vehicle. Always take your keys and lock all doors when leaving the vehicle.

SecuriLock®

The system is an engine immobilization system. It helps to prevent anyone from starting the engine without using a coded key programmed to your vehicle. Using the wrong key could prevent the engine from starting. A message may appear in the information display.

If you are unable to start the engine with a correctly coded key, there is a problem with the system and a message could appear in the information display.

Automatic Arming

The vehicle arms immediately after you switch the ignition off.

Automatic Disarming

Switching the ignition on with a coded key disarms the vehicle.

Replacement Keys

Note: Your vehicle comes with two integrated keyhead transmitters or two intelligent access keys.

The integrated keyhead transmitter functions as a programmed ignition key that operates all the locks and starts the vehicle, as well as a remote control.

The intelligent access key functions as a programmed key that operates the driver door lock and activates the intelligent access with push button start system, as well as a remote control.

If your programmed transmitters or standard SecuriLock coded keys (integrated keyhead transmitters only) are lost or stolen and you do not have an extra coded key, you will need to have your vehicle towed to an authorized dealer. You need to erase the key codes from your vehicle and program new coded keys.

Store an extra programmed key away from the vehicle in a safe place to help prevent any inconveniences. See your authorized dealer to purchase additional spare or replacement keys.

Programming a Spare Intelligent Access Key (If Equipped)

See your authorized dealer to have additional keys programmed to your vehicle.

ANTI-THEFT ALARM

The system will warn you of an unauthorized entry to your vehicle. It will be triggered if any door, the luggage compartment or the hood is opened without using the key, remote control or keyless entry keypad.

The direction indicators will flash and the horn will sound if unauthorized entry is attempted while the alarm is armed.

Security

Take all remote controls to an authorized dealer if there is any potential alarm problem with your vehicle.

Arming the Alarm

The alarm is ready to arm when there is not a key in your vehicle. Electronically lock your vehicle to arm the alarm.

Disarming the Alarm

Disarm the alarm by any of the following actions:

- Unlock the doors or luggage compartment with the remote control or keyless entry keypad.
- Switch your vehicle on or start your vehicle.
- Use a key in the driver door to unlock your vehicle, then switch your vehicle on within 12 seconds.

Note: *Pressing the panic button on the remote control will stop the horn and signal indicators, but will not disarm the system.*

Steering Wheel

ADJUSTING THE STEERING WHEEL - VEHICLES WITH: MANUAL ADJUSTABLE STEERING COLUMN



WARNING: Do not adjust the steering wheel when your vehicle is moving.

Note: Make sure that you are sitting in the correct position. See **Sitting in the Correct Position** (page 144).

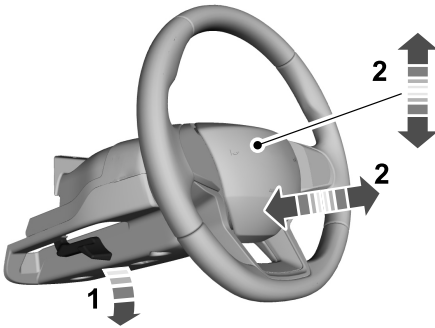

E279960

1. Unlock the steering column.
2. Adjust the steering wheel to the desired position.

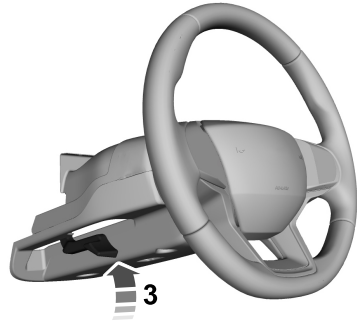

E279962

3. Lock the steering column.

ADJUSTING THE STEERING WHEEL - VEHICLES WITH: POWER ADJUSTABLE STEERING COLUMN



WARNING: Do not adjust the steering wheel when your vehicle is moving.

Note: Make sure that you are sitting in the correct position. See **Sitting in the Correct Position** (page 144).

Steering Wheel



Use the control on the side of the steering column to adjust the position.

To adjust:

- Tilt: Press the top or bottom of the control.
- Telescope: Press the front or rear of the control.

End of Travel Position

The steering column stops just short of the end of the column travel to prevent damage to the steering column. A new stopping position sets if it encounters an object when tilting or telescoping.

To reset the steering column to its normal stopping position:

1. Confirm there is nothing obstructing the motion of the steering column.
2. Press and hold the steering column control until the steering column stops moving.
3. Press the steering column control again.

Note: *The steering column may begin to move again.*

4. When the steering column stops, continue holding the control for a few seconds.
5. Repeat for each direction as necessary.

A new stopping position sets. The next time you tilt or telescope the steering column, it stops just short of the end of the column travel.

Memory Feature

You can save and recall the steering column position with the memory function. See **Memory Function** (page 150).

Pressing the adjustment control during a memory recall cancels the operation.

Easy Entry and Exit Feature

The column moves up when you switch the ignition off. Switch the ignition on to return the system to its previous settings. You can switch this feature on or off through the touchscreen. See **Settings** (page 458).

Note: *If you press any adjustment or memory button when in easy exit mode, the system cancels the operation.*

Note: *Depending on your vehicle, the column may move up and in.*

Steering Wheel

AUDIO CONTROL



E280796



Press to access the previous media selection.



Press to access the next media selection.

VOICE CONTROL

The controls are on the steering wheel.



Press and release to activate voice recognition.

CRUISE CONTROL - VEHICLES WITH: CRUISE CONTROL



E280796



E280796

You can operate the following functions with the control:



Press to decrease volume level.



Press to increase volume level.



Press to silence the current media



Press to access phone mode or to answer a phone call.



Press to end a phone call.

See **What Is Cruise Control** (page 239).

Steering Wheel

CRUISE CONTROL - VEHICLES WITH: STOP AND GO



See **How Does Adaptive Cruise Control With Stop and Go Work** (page 241).

INFORMATION DISPLAY CONTROL



See **Information Displays** (page 110).

HEATED STEERING WHEEL (IF EQUIPPED)

The heated steering wheel button is on the climate controls.



Press the button to switch the heated steering wheel on and off.

Note: You can use the heated steering wheel only when the engine is running.

Note: The system uses a sensor and is designed to control the temperature of the steering wheel and to prevent it from overheating.

Note: In warm temperatures, the steering wheel quickly reaches its maximum temperature and the system reduces the current to the heating element. This could cause you to think that the system has stopped working but it has not. This is normal.

HORN



Press on the center of the steering wheel near the horn icon to activate the horn.

Wipers and Washers

WINDSHIELD WIPERS



Push the lever up or down to operate the windshield wipers.

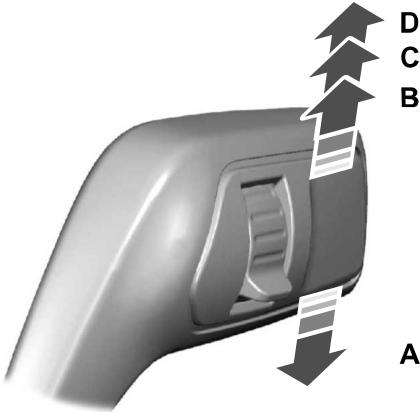

- A Single wipe.
- B Intermittent wipe.
- C Normal wipe.
- D High-speed wipe.

Note: Fully defrost the windshield before you switch the windshield wipers on.

Note: Make sure that you switch the windshield wipers off before entering a car wash.

Note: If streaks or smears appear on the windshield, clean the windshield and the wiper blades. If that does not resolve the issue, install new wiper blades.

Note: Do not operate the wipers on a dry windshield. This may scratch the glass, damage the wiper blades or cause the wiper motor to burn out. Always use the windshield washers before wiping a dry windshield.

Intermittent Wipe

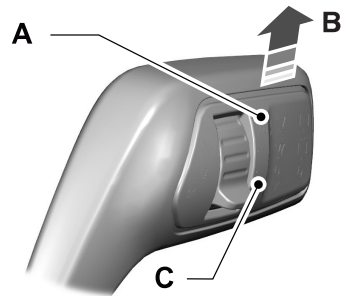

- A Shortest wipe interval.
- B Intermittent wipe.
- C Longest wipe interval.

Use the rotary control to adjust the intermittent wipe interval.

Speed Dependent Wipers

When your vehicle speed increases, the interval between wipes decreases.

AUTOWIPERS (IF EQUIPPED)

Wet or winter driving conditions with ice, snow or salty road mist can cause inconsistent and unexpected wiping or smearing.

Wipers and Washers

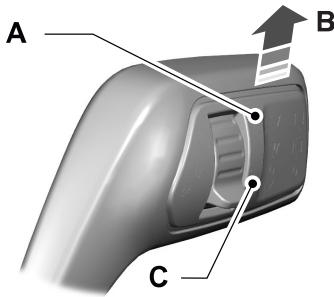

- A High sensitivity.
- B Autowipers On.
- C Low sensitivity.

Use the rotary control to adjust the sensitivity of the autowipers. When you select low sensitivity, the wipers operate when the sensor detects a large amount of water on the windshield. When you select high sensitivity, the wipers operate when the sensor detects a small amount of water on the windshield.

Keep the outside of the windshield clean. The rain sensor is very sensitive and the wipers may operate if dirt, mist or insects hit the windshield.

In these conditions, you can do the following:

- Lower the sensitivity of the autowipers to reduce the amount of smearing on the windshield.
- Switch to normal or high-speed wipe.
- Switch autowipers off.

Note: Fully defrost the windshield before you switch the windshield wipers on.

Note: Make sure that you switch the windshield wipers off before entering a car wash.

Note: If streaks or smears appear on the windshield, clean the windshield and the wiper blades. If that does not resolve the issue, install new wiper blades.

Note: If you switch autolamps and autowipers on, the headlamps turn on when the windshield wipers continuously operate.

Autowipers Settings

Autowipers defaults to on and remains on until you switch it off in the information display. When you switch off autowipers, the wipers operate in intermittent mode.

WINDSHIELD WASHERS



E242323



Pull the lever toward you to operate the windshield washers.

When you release the lever, the wipers operate for a short time. When activated, a courtesy wipe occurs a short time after the wipers stop to clear any remaining washer fluid.

Note: You can switch courtesy wipe on or off in the touchscreen.

Note: Do not operate the washers when the washer reservoir is empty. This could cause the washer pump to overheat.

Wipers and Washers

REAR WINDOW WIPER AND WASHERS

Rear Window Wiper

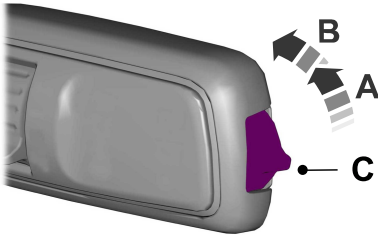

- A Intermittent wipe.
- B Continuous wipe.
- C Rear window wiper off.

Depending on your vehicle, when you switch on the front wipers and move the gearshift lever to reverse (R), the rear intermittent wipe may turn on.

Note: Make sure you switch the rear window wiper off before entering a car wash.

Rear Window Washer



Push the lever away from you to operate the rear window washer. When you release the lever, the wipers operate for a short time.

Do not operate the washers when the washer reservoir is empty. This could cause the washer pump to overheat.

Rear Camera Washer (If Equipped)

Switching on the rear washer also turns on the rear camera washer.

Lighting

GENERAL INFORMATION

Condensation in the Exterior Front Lamps and Rear Lamps

Exterior front lamps and rear lamps have vents to accommodate normal changes in air pressure.

Condensation can be a natural by-product of this design. When moist air enters the lamp assembly through the vents, there is a possibility that condensation can occur when the temperature is cold. When normal condensation occurs, a fine mist can form on the interior of the lens. The fine mist eventually clears and exits through the vents during normal operation.

Clearing time may take as long as 48 hours under dry weather conditions.

Examples of acceptable condensation are:

- The presence of a fine mist (no streaks, drip marks or large droplets).
- A fine mist covers less than 50% of the lens.

Examples of unacceptable condensation are:

- A water puddle inside the lamp.
- Streaks, drip marks or large droplets present on the interior of the lens.

If you see any unacceptable condensation, have your vehicle checked by an authorized dealer.

LIGHTING CONTROL

Lighting Control Selections

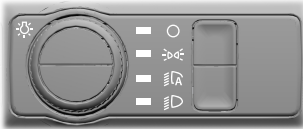

E281337

Turn the dial to make a selection.

Note: *The indicator illuminates next to the active selection.*



Lamps off.



Parking lamps, instrument panel lamps, license plate lamps and rear lamps.



Autolamps.



Headlamps on.

Note: *The lighting control defaults to autolamps every time you switch your vehicle on.*

Switching High Beam Headlamps On and Off

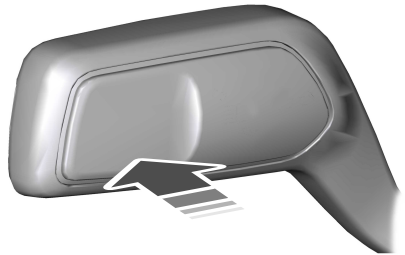

Push the lever away from you to switch the high beam on.

Push the lever forward again or pull the lever toward you to switch the high beams off.

Lighting

Flashing High Beam Headlamps

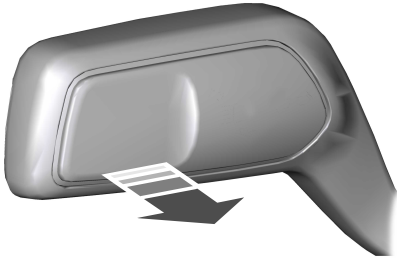

E248604

Pull the lever toward you and release it to flash the high beam headlamps.

AUTOLAMPS



WARNING: The system does not relieve you of your responsibility to drive with due care and attention. You may need to override the system if it does not turn the headlamps on in low visibility conditions, for example daytime fog.

Autolamps turn the headlamps on in low light situations or when the wipers operate.



Switch the lighting control to the autolamps position.

Note: The lighting control defaults to autolamps each time you switch your vehicle on.

The headlamps remain on for a period of time after you switch the ignition off. Use the touchscreen to adjust the period of time that the headlamps remain on.

Note: If you switch the autolamps on, you cannot switch the high beams on until the system turns the low beams on.

Windshield Wiper Activated Headlamps

When you switch the autolamps on, the headlamps turn on within 10 seconds of switching the wipers on. They turn off approximately 60 seconds after you switch the windshield wipers off.

The headlamps do not turn on with the wipers:

- During a single wipe.
- When using the windshield washers.
- If the wipers are in intermittent mode.

Note: If you switch the autolamps and the autowipers on, the headlamps turn on when the windshield wipers continuously operate.

INSTRUMENT LIGHTING DIMMER

The instrument lighting dimmer buttons are on the lighting control.



Repeatedly press one of the buttons to adjust the brightness.



HEADLAMP EXIT DELAY

After you switch the ignition off, you can switch the headlamps on by pulling the direction indicator lever toward you. You will hear a short tone. The headlamps will switch off automatically after three minutes with any door open or 30 seconds after the last door has been closed. You can cancel this feature by pulling the direction indicator lever toward you again or switching the ignition on.

Lighting

DAYTIME RUNNING LAMPS - VEHICLES WITH: CONFIGURABLE DAYTIME RUNNING LAMPS



WARNING: The daytime running lamps system does not activate the rear lamps and may not provide adequate lighting during low visibility driving conditions. Make sure you switch the headlamps on, as appropriate, during all low visibility conditions. Failure to do so may result in a crash.

Switch the daytime running lamps on or off using the touchscreen:

1. Select **Settings**. See **Settings** (page 458).
2. Select **Vehicle**.
3. Select **Lighting**.

The daytime running lamps turn on when:

1. The lamps are on in the information display.
2. You switch the ignition on.
3. The transmission is not in park (P) for vehicles with automatic transmissions or you release the parking brake for vehicles with manual transmissions.
4. The lighting control is in the autolamps position.
5. The headlamps are off.

The other lighting control switch positions do not turn on the daytime running lamps.

If the daytime running lamps are off in the information display, the lamps stay off in all switch positions.

DAYTIME RUNNING LAMPS - VEHICLES WITH: DAYTIME RUNNING LAMPS (DRL)



WARNING: The daytime running lamps system does not activate the rear lamps and may not provide adequate lighting during low visibility driving conditions. Make sure you switch the headlamps on, as appropriate, during all low visibility conditions. Failure to do so may result in a crash.

The system turns the lamps on in daylight conditions.

Daytime running lamps are always on unless the headlamps are on or your vehicle is in park (P).

FRONT FOG LAMPS (IF EQUIPPED)

Using the Front Fog Lamps

To switch the lamps on or off:

1. Set the lighting control to the parking lamps, headlamps or autolamps position.

Note: *When the lighting control is in the autolamps position, you cannot switch the fog lamps on unless the low beam headlamps are on.*

2.



Press the button on the lighting control to switch the front fog lamps on or off.

Note: *Only switch the front fog lamps on during reduced visibility.*

Note: *The brightness of the daytime running lamps may decrease when the front fog lamps are on.*

Lighting

Note: The lights on the front fog lamps turn off when you switch the high beams on.

Front Fog Lamp Indicator



It illuminates when you switch the front fog lamps on.

ADAPTIVE HEADLAMPS (IF EQUIPPED)

The headlamp beams move in the same direction as the steering wheel. This provides more visibility when driving around curves.

- A. Without adaptive headlamps.
- B. With adaptive headlamps.

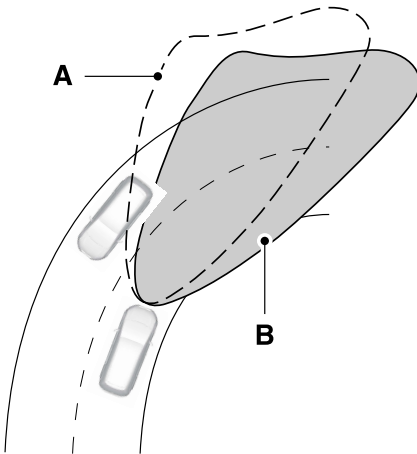

The system only works with the lighting control in the autolamp position.

You can switch the system on or off in the touchscreen.

Note: There is a delay of two to five seconds before the system operates when you drive your vehicle.

Note: The system is only active at speeds above 3 mph (5 km/h).

System Check (If Equipped)

The system has a power-up movement check feature. When you start your vehicle, the lamps track left to right, then back to center to alert the driver that the system is working properly.

DIRECTION INDICATORS

Switching the Direction Indicators On and Off



Push the lever up or down to switch the direction indicators on.

Note: Tap the lever up or down to make the direction indicators flash three times.

Set the lever to the middle position to switch the direction indicators off.

Lighting

Direction Indicator



Flashes when you switch the direction indicators on.

Note: An increase in the rate of flashing warns of a failed indicator bulb.

INTERIOR LAMPS

The lamps turn on under the following conditions:

- You open any door.
- You press a button on the remote control.
- You press the all lamps on button on the overhead console.

Front Interior Lamp



The front interior lamp switches are on the overhead console.

Note: The position of each button on the overhead console depends on your vehicle.

All Lamps On or Off



Press to switch all interior lamps on or off.

Individual Map Lamps



Press to switch the left-hand individual dome lamp on and off.



Press to switch the right-hand individual dome lamp on and off.

Interior Lamp Function



Press to switch the interior lamp function on and off.

When the interior lamp function is off and you open a door, the courtesy and door lamps stay off.

When the interior lamp function is on and you open a door, the courtesy and door lamps turn on.

Note: The indicator lamp lights amber when the door function is off.

Rear Interior Lamps



The rear interior lamps may be above the rear seat or above the rear windows.



Press to switch the lamps on or off.

Note: If you switch the rear lamps on through the overhead console, you cannot switch them off with the rear lamp switch.

AMBIENT LIGHTING - VEHICLES WITH: 8 INCH CENTER DISPLAY SCREEN

Use the touchscreen to select the following:

Lighting



Select the settings option on the feature bar.



Select ambient lighting.



E280369

Switching Ambient Lighting On

Touch a color once.

Changing the Color

Touch any color once.

Adjusting the Brightness

Drag the selected color up or down.

Switching Ambient Lighting Off

Touch the selected color once or drag the selected color down to zero brightness.

AMBIENT LIGHTING - VEHICLES WITH: 10.1 INCH CENTER DISPLAY SCREEN

Use the touchscreen to select the following:



Select the settings option on the feature bar.



Select ambient lighting.

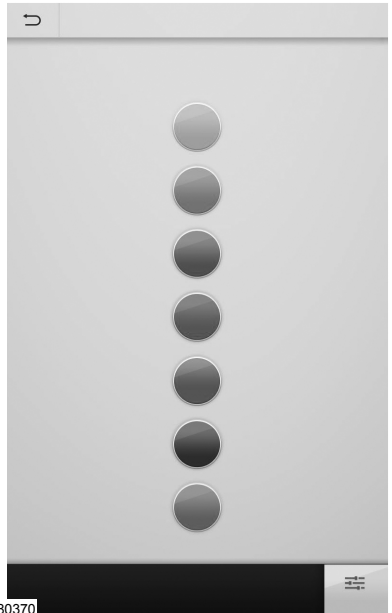

E280370

Switching Ambient Lighting On

Touch a color once.

Changing the Color

Touch any color once.

Adjusting the Brightness

Drag the selected color left or right.

Switching Ambient Lighting Off

Touch the selected color once or drag the selected color left to zero brightness.

Automatic High Beam Control

WHAT IS AUTOMATIC HIGH BEAM CONTROL

The system turns on high beams if it is dark enough and no other traffic is present. If it detects an approaching vehicle's headlamps or tail lamps, or street lighting ahead, the system turns the high beams off. Low beams remain on.

A camera sensor, centrally mounted behind the windshield of your vehicle, continuously monitors conditions to turn the high beams on and off.

SWITCHING AUTOMATIC HIGH BEAM CONTROL ON AND OFF



WARNING: Do not use the system in poor visibility, for example fog, heavy rain, spray or snow.

Use the touchscreen to select the following:

1. Select **Settings**.
2. Select **Vehicle**.
3. Select **Lighting**.

Activating the Automatic High Beam Control



Switch the lighting control to the autolamps position. See **Autolamps** (page 87).

Note: The lighting control defaults to autolamps each time you switch your vehicle on.

When active, the high beams turn on if all the following conditions occur:

- The ambient light level is low enough.
- There is no traffic in front of your vehicle.
- The vehicle speed is greater than approximately 25 mph (40 km/h).

When active, the high beams turn off if at least one of the following conditions occur:

- The ambient light level is high enough that you do not require high beams.
- The system detects an approaching vehicle's headlamps or tail lamps.
- The system detects severe rain, snow or fog.
- A blocked vehicle camera.
- The vehicle speed falls below approximately 19 mph (30 km/h).

Note: The deactivation speed is lower on curves.

Note: Certain curvy road situations may delay high beam reactivation.

Note: If you have a blocked sensor, the system may not operate properly. Keep the windshield free from obstruction or damage.

Note: The system may not operate properly in cold or inclement conditions. You can switch on the high beams by overriding the system.

Note: If the system detects a blockage, for example bird droppings, bug splatter, snow or ice, the system goes into low beam mode until you clear the blockage. If you have a blocked camera, a message may appear in the information display.

Note: Using much larger tires or equipping vehicle accessories such as snowplows can modify your vehicle's ride height and degrade automatic high beam control performance.

Automatic High Beam Control

AUTOMATIC HIGH BEAM CONTROL INDICATORS



The indicator illuminates to confirm when the system is ready to assist.

OVERRIDING AUTOMATIC HIGH BEAM CONTROL



WARNING: The system does not relieve you of your responsibility to drive with due care and attention. You may need to override the system if it does not turn the high beams on or off.



WARNING: You may need to override the system when approaching other road users.



WARNING: You may need to override the system during inclement weather.

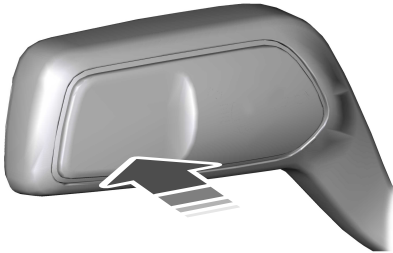

Push the lever away from you to switch between high beam and low beam.

Windows and Mirrors

POWER WINDOWS



WARNING: Do not leave children unattended in your vehicle and do not let them play with the power windows. Failure to follow this instruction could result in personal injury.



WARNING: When closing the power windows, verify they are free of obstruction and make sure that children and pets are not in the proximity of the window openings.



Press the control to open the window. Lift the control to close the window.

Note: If you hear a pulsing noise when just one of the windows is open. Lower the opposite window slightly to reduce this noise.

One-Touch Down

Note: One-touch down applies to the front windows only.

Fully press the switch and release it. Press again or lift it to stop the window.

One-Touch Up

Note: One-touch up applies to the front windows only.

Fully lift the switch and release it. Press or lift it again to stop the window.

Resetting One-Touch Up

Start the engine.

1. Lift and hold the window switch until you fully close the door window. Continue to hold the switch for a few seconds after you close the window.
2. Release the window switch.

3. Press and hold the window switch until you fully open the door window.
4. Release the window switch.
5. Lift and hold the window switch until you fully close the window.
6. Test for correct window operation by carrying out the one-touch down and one-touch up features.

Bounce-Back

The window stops when closing. It reverses some distance if there is an obstacle in the way.

Overriding the Bounce-Back Feature



WARNING: If you override bounce-back, the window does not reverse if it detects an obstacle. Take care when closing the windows to avoid personal injury or damage to your vehicle.

The window stops if you release the switch before the window fully closes. Pull up the window switch and hold within a few seconds of the window reaching the bounce-back position. The window travels up with no bounce-back protection.

Window Lock



Windows and Mirrors

Press the control to lock or unlock the rear window controls. It illuminates when you lock the rear window controls.

Accessory Delay

You can use the window switches for several minutes after you switch the ignition off or until you open either front door.

GLOBAL OPENING

You can use the remote control to open the windows with the ignition off.

Note: You can enable or disable this feature in the information display, or see an authorized dealer. See **General Information** (page 115).

Note: To operate this feature, accessory delay must not be active.

Remote Control Front Windows

After you unlock your vehicle with the remote control, you can open the windows for a short period of time. Press and hold the remote control unlock button to open the windows. Release the button once movement starts. Press the lock or unlock button to stop movement.

EXTERIOR MIRRORS - EXCLUDING: ST

Power Exterior Mirrors



WARNING: Do not adjust the mirrors when your vehicle is moving. This could result in the loss of control of your vehicle, serious personal injury or death.

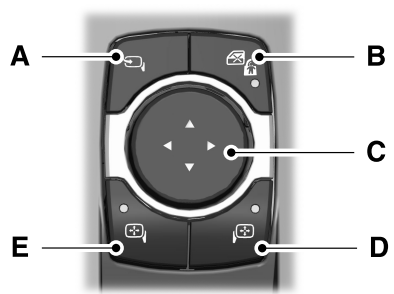

- A Power-folding mirror control.
- B Window lockout.
- C Adjustment control.
- D Right-hand mirror.
- E Left-hand mirror.

To adjust your mirrors, switch your vehicle on with the ignition in accessory mode or the engine running and then:

1. Select the mirror you want to adjust. The control light turns on.
2. Use the adjustment control to adjust the position of the mirror.
3. Press the mirror control again. The control light turns off.

Fold-Away Exterior Mirrors

Push the mirror toward the door window glass. Make sure that you fully engage the mirror in its support when returning it to its original position.

Auto-Folding Mirrors (If Equipped)

The exterior mirrors fold in toward the glass after you place the transmission into park (P), turn off the vehicle and lock the vehicle. The exterior mirrors unfold and return to their driving position after you unlock the vehicle.

Windows and Mirrors

You can switch this feature on and off through the information display. See **General Information** (page 115).

You can fold the mirrors on demand by pressing the power-folding mirror control on the door. The control lights and the mirrors fold in toward the glass. Press the control again to unfold the mirrors. The control light turns off.

Note: *If you use the power-folding control to fold the mirrors on demand with the auto fold feature on, you must use the control again to unfold them.*

Loose Mirror

If you manually fold your power-folding mirrors, they may not work properly even after you re-position them. You need to reset them if:

- The mirrors vibrate when you drive.
- The mirrors feel loose.
- The mirrors do not stay in the folded or unfolded position.
- One of the mirrors is not in its normal driving position.

To reset the power-fold feature, use the power-folding mirror control to fold and unfold the mirrors. You may hear a loud noise as you reset the power-folding mirrors. This sound is normal. Repeat this process as needed each time you manually fold the mirrors.

Heated Exterior Mirrors (If Equipped)

See **Heated Exterior Mirrors** (page 142).

Memory Mirrors (If Equipped)

You can save and recall the mirror positions through the memory function. See **Memory Function** (page 150).

Auto-dimming Feature (If Equipped)

The driver exterior mirror dims when the interior auto-dimming mirror turns on.

Direction Indicator Mirrors (If Equipped)

When the vehicle is running, the forward-facing portion of the appropriate mirror housing blinks when you switch on the direction indicator.

Puddle Lamps (If Equipped)

The lamps on the bottom part of the mirror housing light when you use your transmitter to unlock the doors or when you open a door.

360-Degree Camera (If Equipped)

See **360 Degree Camera** (page 237).

Blind Spot Information System

See **Blind Spot Information System** (page 259).

EXTERIOR MIRRORS - ST

Power Exterior Mirrors



WARNING: Do not adjust the mirrors when your vehicle is moving. This could result in the loss of control of your vehicle, serious personal injury or death.

Windows and Mirrors

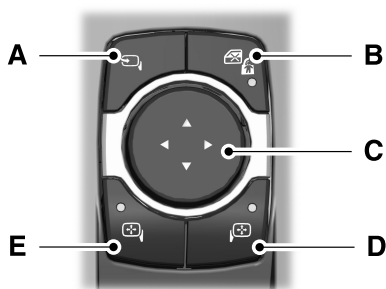

- A Power-folding mirror control.
- B Window lockout.
- C Adjustment control.
- D Right-hand mirror.
- E Left-hand mirror.

To adjust your mirrors, switch your vehicle on, with the ignition in accessory mode or the engine running.

1. Select the mirror you want to adjust. The control light turns on.
2. Use the adjustment control to adjust the position of the mirror.
3. Press the mirror control again. The control light turns off.

Fold-Away Exterior Mirrors (if

Equipped)

Push the mirror toward the door window glass. Make sure that you fully engage the mirror in its support when returning it to its original position.

Auto-Folding Mirrors

The exterior mirrors automatically fold in toward the glass after you place the transmission into park (P), switch the vehicle off, open and close the driver door and lock the vehicle. The exterior mirrors automatically unfold and return to their driving position after you unlock the vehicle and open and close the driver door.

You can switch this feature on and off through the instrument cluster display. See **General Information** (page 115).

You can fold the mirrors on demand by pressing the power-folding mirror control on the door. The control light turns on and the mirrors fold in toward the glass. Press the control again to unfold the mirrors. The control light turns off.

Note: *If you use the power-folding control to fold the mirrors on demand with the auto fold feature on, you must use the control again to unfold them.*

Loose Mirror

If you manually fold your power-folding mirrors, they may not work properly even after you reposition them. You need to reset them if:

- The mirrors vibrate when you drive.
- The mirrors feel loose.
- The mirrors do not stay in the folded or unfolded position.
- One of the mirrors is not in its normal driving position.

To reset the power-fold feature, use the power-folding mirror control to fold and unfold the mirrors. You may hear a loud noise as you reset the power-folding mirrors. This sound is normal. Repeat this process as needed each time you manually fold the mirrors.

Windows and Mirrors

Heated Exterior Mirrors

See **Heated Exterior Mirrors** (page 142).

Memory Mirrors

You can save and recall the mirror positions through the memory function. See **Memory Function** (page 150).

Auto-dimming Feature (If Equipped)

The driver exterior mirror dims when the interior auto-dimming mirror turns on.

Direction Indicator Mirrors (If Equipped)

When the vehicle is running, the forward-facing portion of the appropriate mirror housing blinks when you switch on the direction indicator.

Puddle Lamps

The lamps on the bottom part of the mirror housing illuminate when you use your remote control to unlock the doors or when you open a door.

360-Degree Camera (If Equipped)

See **360 Degree Camera** (page 237).

Blind Spot Information System

See **Blind Spot Information System** (page 259).

INTERIOR MIRROR



WARNING: Do not adjust the mirrors when your vehicle is moving. This could result in the loss of control of your vehicle, serious personal injury or death.

Note: Do not clean the mirror housing or glass with harsh abrasives, fuel or other petroleum-based cleaning products.

You can adjust the interior mirror to your preference. Some mirrors also have a second pivot point. This lets you move the mirror head up or down and from side to side.

Manual Dimming Mirror

Pull the tab below the mirror toward you to reduce the effect of bright light from behind.

Automatic Dimming Mirror (If Equipped)

Note: Do not block the sensors on the front and back of the mirror. A rear center passenger or raised rear center head restraint may also block light from reaching the sensor.

The mirror dims to reduce the effect of bright light from behind. It returns to normal when the bright light from behind is no longer present or if you shift into reverse (R).

SUN VISORS

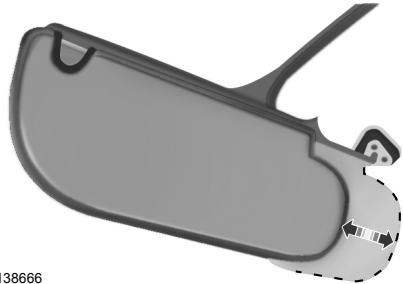

E138666

Rotate the sun visor toward the side window and extend it rearward for extra shade.

Windows and Mirrors

Illuminated Vanity Mirror

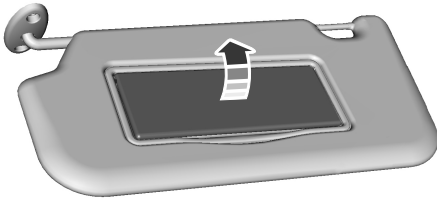

E162197

Lift the cover to switch the lamp on.

SUN SHADES

Rear Side Windows

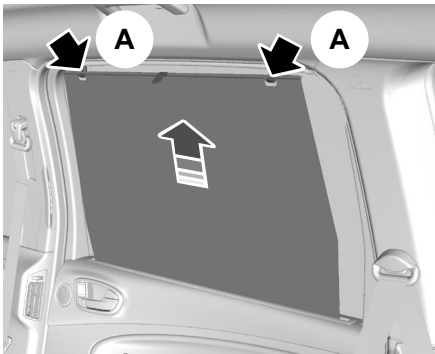

E74809

Pull the blind up and attach it to the hooks A.

MOONROOF (IF EQUIPPED)

WARNING: Do not leave children unattended in your vehicle and do not let them play with the moonroof. Failure to follow this instruction could result in personal injury.

WARNING: When closing the moonroof, verify that it is free of obstruction and make sure that children and pets are not in the proximity of the roof opening.

The moonroof controls are on the overhead console and have a one-touch open and close feature. To stop it during one-touch operation, press the control a second time.

Opening and Closing the Moonroof



A **Moonroof open.** Press and release to open the moonroof.

B **Moonroof vent or close.** Press and release to vent or close the moonroof.

Windows and Mirrors

- C **Sunshade open.** Press and release to open the sunshade. The sunshade opens with the moonroof. You can also manually open the sunshade with the moonroof closed.
- D **Sunshade close.** Press and release to close the sunshade.

Note: The sunshade stops short of the fully open position for the comfort of rear passengers. To fully open the sunshade, press the control again.

Note: When closing, the sunshade stops at the first panel for the dual panel moonroof. Press and release again to continue to fully close the sunshade.

Rear SunShade Opening and Closing (If Equipped)

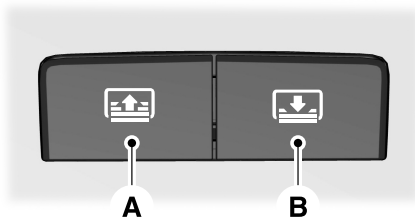

- A **Sunshade close.** Press and release to close the sunshade.
- B **Sunshade open.** Press and release to open the sunshade. The sunshade opens with the moonroof. You can also manually open the sunshade with the moonroof closed.

Note: The rear sunshade open and close controls can be on the rear console or fold down armrest bezel.

Note: The sunshade stops short of its fully opened position for the comfort of rear passengers. To fully open the sunshade, press the control again.

Bounce-Back

The moonroof reverses some distance if it detects an obstacle when closing.

To override this feature, press and hold the moonroof close control within two seconds after the roof comes to a stop following a bounce-back reversal.

Instrument Cluster

GAUGES - VEHICLES WITH: 6.5 INCH INSTRUMENT CLUSTER DISPLAY SCREEN

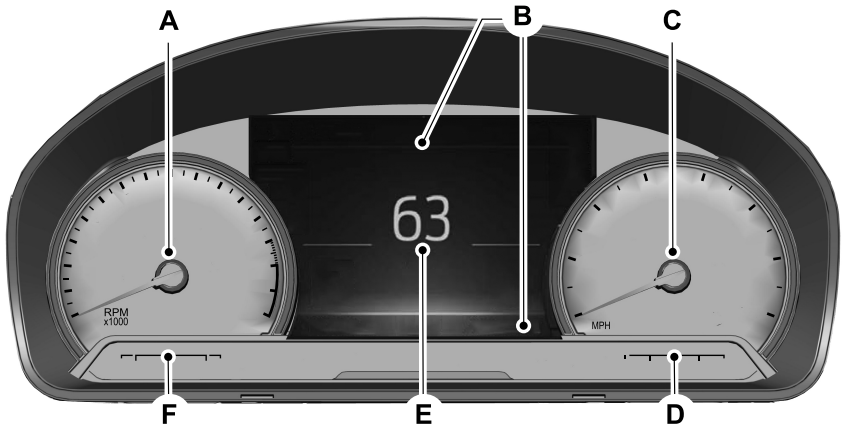

- A Tachometer.
- B Information bar.
- C Speedometer.
- D Fuel gauge.
- E Information display.
- F Engine coolant temperature gauge.

Information Bar

Displays information related to the navigation, outside air temperature, odometer and distance to empty.

Information Display

Displays information related to the navigation, outside air temperature, odometer and distance to empty.

Information Display

Information that appears depends on your vehicle settings. See **General Information** (page 115).

Fuel Gauge

The fuel gauge indicates about how much fuel is in the fuel tank.

The arrow adjacent to the fuel pump symbol indicates on which side of your vehicle the fuel filler door is located.

Instrument Cluster

Note: *The fuel gauge may vary slightly when your vehicle is moving or on a slope.*

Low Fuel Reminder

A low fuel level reminder displays and sounds when the distance to empty reaches 75 mi (120 km) to empty for MyKey, and at 50 mi (80 km), 25 mi (40 km), 10 mi (20 km) and 0 mi (0 km) for all vehicle keys.

Note: *The low fuel reminder can appear at different fuel gauge positions depending on fuel economy conditions. This variation is normal.*

Distance to Empty

Indicates the approximate distance your vehicle can travel on the fuel remaining in the tank. Changes in driving pattern can cause the value to not only decrease but also increase or stay constant for periods of time.

Engine Coolant Temperature Gauge



WARNING: Do not remove the coolant reservoir cap when the engine is on or the cooling system is hot. Wait 10 minutes for the cooling system to cool down. Cover the coolant reservoir cap with a thick cloth to prevent the possibility of scalding and slowly remove the cap. Failure to follow this instruction could result in personal injury.

Indicates engine coolant temperature. At normal operating temperature, the level indicator will be in the normal range. If the engine coolant temperature exceeds the normal range, stop your vehicle as soon as safely possible, switch off the engine and let the engine cool.

GAUGES - VEHICLES WITH: 12.3 INCH INSTRUMENT CLUSTER DISPLAY SCREEN

Note: *Clusters shown in single gauge view.*

Note: *Displays may appear slightly different depending on region.*

Instrument Cluster

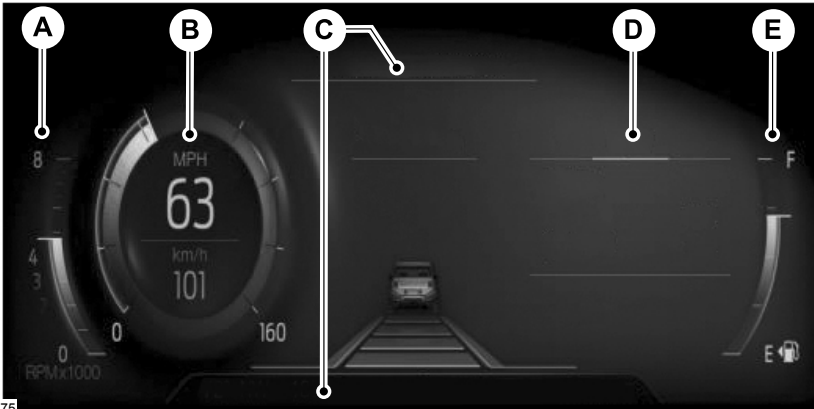

E281475

- A Gauge display.
- B Speedometer.
- C Information bar.
- D Information display.
- E Fuel gauge.

Gauge Display

Displays different gauge selections depending on supported options. Options include Tachometer or Engine Coolant Temperature.

Information Bar

Displays information related to the current audio source, navigation, outside air temperature and distance to empty.

Information Display

Information that appears depends on current gauge view and on-demand settings. See **General Information** (page 115).

Fuel Gauge

The fuel gauge indicates about how much fuel is in the fuel tank.

The arrow adjacent to the fuel pump symbol indicates on which side of your vehicle the fuel filler door is located.

Note: *The fuel gauge may vary slightly when your vehicle is moving or on a slope.*

Low Fuel Reminder

A low fuel level reminder displays and sounds when the distance to empty reaches 75 mi (120 km) to empty for MyKey, and at 50 mi (80 km), 25 mi (40 km), 10 mi (20 km) and 0 mi (0 km) for all vehicle keys.

Instrument Cluster

Note: The low fuel reminder can appear at different fuel gauge positions depending on fuel economy conditions. This variation is normal.

Distance to Empty

Indicates the approximate distance your vehicle can travel on the fuel remaining in the tank. Changes in driving pattern can cause the value to not only decrease but also increase or stay constant for periods of time.

Engine Coolant Temperature Gauge



WARNING: Do not remove the coolant reservoir cap when the engine is on or the cooling system is hot. Wait 10 minutes for the cooling system to cool down. Cover the coolant reservoir cap with a thick cloth to prevent the possibility of scalding and slowly remove the cap. Failure to follow this instruction could result in personal injury.

Indicates engine coolant temperature. At normal operating temperature, the level indicator will be in the normal range. If the engine coolant temperature exceeds the normal range, stop your vehicle as soon as safely possible, switch off the engine and let the engine cool.

GAUGES - VEHICLES WITH: 4.2 INCH INSTRUMENT CLUSTER DISPLAY SCREEN

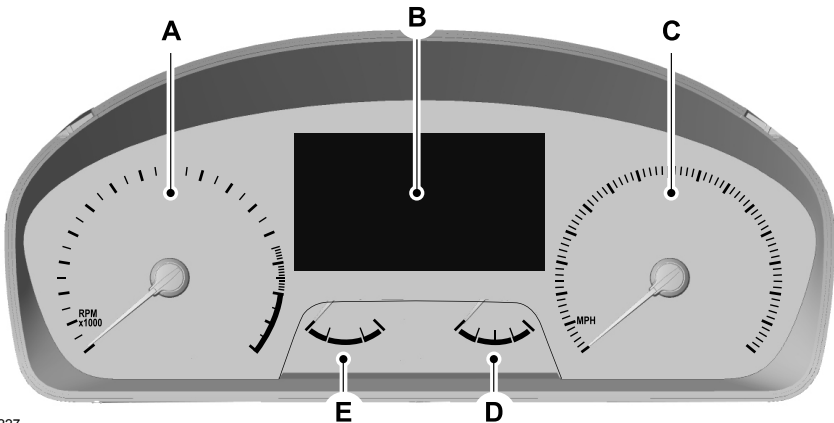

E282227

Instrument Cluster

- A Tachometer.
- B Information display.
- C Speedometer.
- D Fuel gauge.
- E Engine coolant temperature gauge.

Information Display

Information that appears depends on your vehicle settings. See **General Information** (page 115).

Fuel Gauge

The fuel gauge indicates about how much fuel is in the fuel tank.

The arrow adjacent to the fuel pump symbol indicates on which side of your vehicle the fuel filler door is located.

Note: *The fuel gauge may vary slightly when your vehicle is moving or on a slope.*

Low Fuel Reminder

A low fuel level reminder displays and sounds when the distance to empty reaches 75 mi (120 km) to empty for MyKey, and at 50 mi (80 km), 25 mi (40 km), 10 mi (20 km) and 0 mi (0 km) for all vehicle keys.

Note: *The low fuel reminder can appear at different fuel gauge positions depending on fuel economy conditions. This variation is normal.*

Engine Coolant Temperature Gauge

Indicates engine coolant temperature. At normal operating temperature, the level indicator will be in the normal range. If the engine coolant temperature exceeds the normal range, stop your vehicle as soon as safely possible, switch off the engine and let the engine cool.



WARNING: Do not remove the coolant reservoir cap when the engine is on or the cooling system is hot. Wait 10 minutes for the cooling system to cool down. Cover the coolant reservoir cap with a thick cloth to prevent the possibility of scalding and slowly remove the cap. Failure to follow this instruction could result in personal injury.

WARNING LAMPS AND INDICATORS

The following warning lamps and indicators alert you to a vehicle condition that may become serious. Some lamps illuminate when you start your vehicle to make sure they work. If any lamps remain on after starting your vehicle, refer to the respective system warning lamp for further information.

Note: *Some warning indicators appear in the information display and function the same as a warning lamp, but do not display when you start your vehicle.*

Adaptive Cruise Control (if Equipped)



The cruise control system indicator light changes color to indicate what mode the system is in. See **How Does Adaptive Cruise Control With Stop and Go Work** (page 241).

Instrument Cluster

On (white light): Illuminates when you switch on the adaptive cruise control system. Turns off when you switch the cruise control system off.

Engaged (green light): Illuminates when you engage the adaptive cruise control system. Turns off when you disengage the cruise control system.

Anti-Lock Braking System



If it illuminates when you are driving, this indicates a system error. You continue to have the normal braking (without ABS) unless the brake system warning lamp also illuminates. Have the system checked.

Automatic High Beam Control



Illuminates when this feature is on. See **What Is Automatic High Beam Control** (page 92).

Auto Hold Active



Illuminates when the system holds your vehicle stationary.



Auto Hold Unavailable



Illuminates when the system is on, but unavailable to hold your vehicle stationary.



Auto Start-stop (If Equipped)



Illuminates when the engine shuts down or in conjunction with a message.

Battery



If it illuminates while driving, it indicates a system error. Immediately switch off all unnecessary electrical equipment and have the system checked.

Blind Spot Monitor



Illuminates when you switch this feature off or in conjunction with a message. See **Blind Spot Information System** (page 259).

Brake System Warning Lamp



WARNING: Driving your vehicle with the warning lamp on is dangerous. A significant decrease in braking performance may occur. It may take you longer to stop your vehicle. Have your vehicle checked as soon as possible. Driving extended distances with the parking brake engaged can cause brake failure and the risk of personal injury.

Note: *Indicators vary depending on region.*

This lamp is a dual function lamp and illuminates when:

- You apply the parking brake with the ignition on.
- Your vehicle has a brake fault or low brake fluid level, regardless of parking brake position.



If the lamp illuminates when you are moving, you may have the parking brake applied. Make sure the parking brake is off. Have your vehicle checked as soon as possible if the lamp continues to illuminate.

Instrument Cluster

Cruise Control (If Equipped)



Illuminates when you switch this feature on.

Direction Indicator



Illuminates when you switch on the left or right direction indicator or the hazard flasher. If the indicators stay on or flash faster, check for a burned out bulb. See **Changing a Bulb** (page 337).

Door Ajar



Illuminates when the ignition is on and any door is not completely closed.

Electric Park Brake

Note: Indicators vary depending on region.



Illuminates or flashes when the electric parking brake has a system error. See **Electric Parking Brake** (page 211).



Engine or Motor Coolant Temperature



Illuminates when your vehicle coolant temperature is high. Stop your vehicle as soon as possible, switch off your vehicle and let it cool. See **Engine Coolant Check** (page 324).

Engine Oil



If it illuminates with the engine running or when you are driving, this indicates a system error. Stop your vehicle as soon as it is safe to do so and switch the engine off. Check the engine oil level. See **Engine Oil Check** (page 319).

Note: Do not resume your journey if it illuminates despite the level being correct. Immediately have the system checked.

Fasten Seatbelt



Illuminates and a tone sounds to remind you to fasten your seatbelt. See **Seatbelt Reminder** (page 42).

Fasten Rear Seatbelt



Illuminates and a tone sounds to signal the rear seatbelts are not fastened.

Front Airbag



If it does not illuminate when you switch the ignition on, continues to flash or remains on when the engine is running, this indicates a malfunction. Have your vehicle checked as soon as possible.

Front Fog Lamps (If Equipped)



Illuminates when you switch the front fog lamps on.

High Beam



Illuminates when you switch the high beam headlamps on. It flashes when you use the headlamp flasher.

Instrument Cluster

High Voltage Electric System Failure (If Equipped)



It illuminates if your hybrid electric vehicle has an electrical component fault or failure that causes your vehicle to shutdown or enter a limited operating mode. A message may appear in the instrument cluster display.

Hill Descent (If Equipped)



Illuminates when you switch hill descent on.

Hood Ajar



Illuminates when the ignition is on and the hood is not completely closed.

Lamps On



Illuminates when you switch the low beam headlamps or the parking lamps on.

Liftgate Ajar



Illuminates when the liftgate is not completely closed.

Low Beam Warning



Illuminates when the low beam headlamp bulb is not properly functioning.

Low Fuel Level



Illuminates when the fuel level is low or the fuel tank is nearly empty. Refuel as soon as possible.

Low Tire Pressure Warning



Illuminates when the tire pressure is low. If the lamp remains on with the engine running or when driving, check the tire pressure as soon as possible.

It also momentarily illuminates when you switch the ignition on to confirm the lamp is functional. If it does not illuminate when you switch the ignition on, or begins to flash at any time, have the system checked.

Low Washer Fluid



Illuminates when the windshield washer fluid is low.

Powertrain Fault



Illuminates when the system detects a powertrain or a 4WD/AWD fault. Contact an authorized dealer as soon as possible.

Ready to Drive (If Equipped)



Illuminates when you have switched on your hybrid electric vehicle and it is ready to drive. A corresponding message may appear stating ready to drive.

Service Engine Soon



It illuminates when you switch the ignition on prior to engine start to check the bulb and to indicate whether your vehicle is ready for Inspection and Maintenance testing.

Instrument Cluster

Normally, it illuminates until the engine is cranked and automatically turns off if no system errors are present. However, if after 15 seconds it flashes eight times, this indicates that your vehicle is not ready for Inspection and Maintenance testing. See **Catalytic Converter** (page 193).

If it illuminates when the engine is running this indicates a system error. The On Board Diagnostics system has detected an error in the vehicle emission control system.

If it flashes, engine misfire may be occurring. Continuing to drive your vehicle may cause reduced power or the engine to stop. Failure to respond to the warning lamp may cause component damage not covered by the vehicle Warranty. Have your vehicle checked as soon as possible.

Stability Control



It flashes when the system is active. If it remains illuminated or does not illuminate when you switch the ignition on, this indicates a system error. During a system error the system switches off. Immediately have the system checked. See **Using Stability Control** (page 222).

Stability Control Off



Illuminates when you switch the system off. It goes out when you switch the system back on or when you switch the ignition off.

AUDIBLE WARNINGS AND INDICATORS

Key in Ignition Warning Chime (If Equipped)

Sounds when you open the driver's door and you have left the key in the ignition.

Keyless Warning Alert (If Equipped)

Sounds the horn twice when you exit your vehicle with the intelligent access key, after the last door is closed and your keyless vehicle is in RUN, indicating your vehicle is still on.

Headlamps On Warning Chime

Sounds when you remove the key from the ignition and open the driver's door and you have left the headlamps or parking lamps on.

Parking Brake On Warning Chime

Sounds when you have left the parking brake on and drive your vehicle. If the warning chime remains on after you have released the parking brake, have the system checked by an authorized dealer immediately.

Information Displays

GENERAL INFORMATION - VEHICLES WITH: 6.5 INCH INSTRUMENT CLUSTER DISPLAY SCREEN



WARNING: Driving while distracted can result in loss of vehicle control, crash and injury. We strongly recommend that you use extreme caution when using any device that may take your focus off the road. Your primary responsibility is the safe operation of your vehicle. We recommend against the use of any hand-held device while driving and encourage the use of voice-operated systems when possible. Make sure you are aware of all applicable local laws that may affect the use of electronic devices while driving.

You can control various systems on your vehicle using the information display controls on the steering wheel. Corresponding information appears in the instrument cluster display.

Instrument Cluster Display Controls

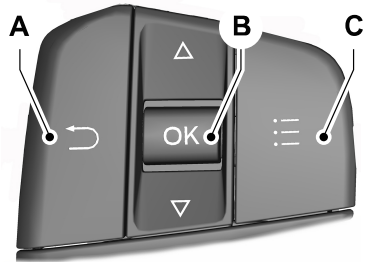

- A Return button.
- B OK button.
- C Menu button.

Return Button

Use the return button to go back or to exit.

OK Button

Use the **OK** button to make a selection. You can also use it to scroll through a menu.

Menu Button

Use the menu button on the main screen to display the submenu.

6 Inch Display Menu



This icon indicates a feature's status. A check in the box indicates the feature is on, and unchecked indicates the feature is off.

Note: Some options may appear slightly different or not at all if the items are optional.

Note: Some MyKey menu options only appear if MyKey is enabled and at least one MyKey is programmed.

Information Displays

Select Screens

Select Screens
Menu options covered in Personalized Settings. See Personalized Settings (page 117).

Audio

Audio
Menu options covered in the SYNC chapter. See General Information (page 427).

Navigation

Navigation
Menu options covered in the SYNC chapter. See General Information (page 427).

Phone

Phone
Menu options covered in the SYNC chapter. See General Information (page 427).

Settings

Settings	
Brake Coach	
Oil Life	Percent Oil Life Indication XXX% Hold Ok to Reset
Tire Monitor	Hold Ok to Reset
Neutral Tow	Hold Ok to Initialize

Note: Additional vehicle settings are available through your touchscreen. See **Settings** (page 458).

Information Displays

Display Setup

Display Setup	
Speedometer units	
Driving History ¹	Hold Ok to Reset

¹Hybrid only

Note: Additional display settings are available through your touchscreen. See **Settings** (page 458).

Hybrid Display Information (if Equipped)

Unique hybrid vehicle information displays on your instrument cluster display when you shut off your vehicle or come to a stop.

Brake Coach

Appears after the vehicle has come to a stop. It coaches you to brake in a manner that maximizes the amount of energy returned through the regenerative braking system.

The percent displayed indicates the regenerative braking efficiency, with 100% representing the maximum amount of energy recovery.

Note: While regenerative braking works in all drive modes, the brake coach display may not be available in all drive modes.

Brake coach can be turned on or off in the settings menu.

Trip Summary

Displays upon shutting off your vehicle. The values are cumulative since you last started your vehicle.

The information shown is the same as the This Trip on demand screen. See **Personalized Settings** (page 117).

GENERAL INFORMATION - VEHICLES WITH: 12.3 INCH INSTRUMENT CLUSTER DISPLAY SCREEN



WARNING: Driving while distracted can result in loss of vehicle control, crash and injury. We strongly recommend that you use extreme caution when using any device that may take your focus off the road. Your primary responsibility is the safe operation of your vehicle. We recommend against the use of any hand-held device while driving and encourage the use of voice-operated systems when possible. Make sure you are aware of all applicable local laws that may affect the use of electronic devices while driving.

You can control various systems on your vehicle using the information display controls on the steering wheel. Corresponding information appears in the instrument cluster display.

Information Displays

Instrument Cluster Display Controls

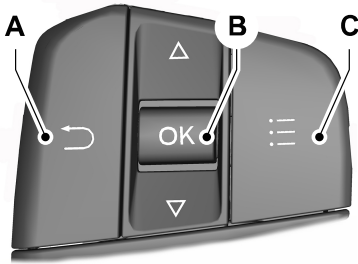

- A Return button.
- B OK button.
- C Menu button.

Return Button

Use the return button to go back or to exit.

Select Screens

Select Screens
Menu options covered in Personalized Settings. See Personalized Settings (page 117).

Audio

Audio
Menu options covered in the SYNC chapter. See General Information (page 427).

Navigation

Navigation
Menu options covered in the SYNC chapter. See General Information (page 427).

OK Button

Use the **OK** button to make a selection. You can also use it to scroll through a menu.

Menu Button

Use the menu button on the main screen to display the submenu.

12 Inch Display Menu



This icon indicates a feature's status. A check in the box indicates the feature is on, and unchecked indicates the feature is off.

Note: Some options may appear slightly different or not at all if the items are optional.

Note: Some MyKey menu options only appear if MyKey is enabled and at least one MyKey is programmed.

Information Displays

Phone

Phone
Menu options covered in the SYNC chapter. See General Information (page 427).

Settings

Settings	
Brake Coach	
Oil Life	Percent Oil Life Indication XXX% Hold Ok to Reset
Tire Monitor	Hold Ok to Reset
Neutral Tow	Hold Ok to Initialize

Note: Additional vehicle settings are available through your touchscreen. See **Settings** (page 458).

Display Setup

Display Setup	
Add Tachometer to View	
Speedometer units	
Driving History ¹	Hold Ok to Reset

¹Hybrid only

Note: Additional display settings are available through your touchscreen. See **Settings** (page 458).

Hybrid Display Information (if Equipped)

Unique hybrid vehicle information displays on your instrument cluster display when you shut off your vehicle or come to a stop.

Brake Coach

Appears after the vehicle has come to a stop. It coaches you to brake in a manner that maximizes the amount of energy returned through the regenerative braking system.

The percent displayed indicates the regenerative braking efficiency, with 100% representing the maximum amount of energy recovery.

Information Displays

Note: While regenerative braking works in all drive modes, the brake coach display may not be available in all drive modes.

Brake coach can be turned on or off in the settings menu.

Trip Summary

Displays upon shutting off your vehicle. The values are cumulative since you last started your vehicle.

The information shown is the same as the This Trip on demand screen. See

Personalized Settings (page 117).

GENERAL INFORMATION - VEHICLES WITH: 4.2 INCH INSTRUMENT CLUSTER DISPLAY SCREEN



WARNING: Driving while distracted can result in loss of vehicle control, crash and injury. We strongly recommend that you use extreme caution when using any device that may take your focus off the road. Your primary responsibility is the safe operation of your vehicle. We recommend against the use of any hand-held device while driving and encourage the use of voice-operated systems when possible. Make sure you are aware of all applicable local laws that may affect the use of electronic devices while driving.

You can control various systems on your vehicle using the quick action menu (QAM) buttons on the right-hand side of the steering wheel. The information display provides the corresponding information.

Information Display Controls

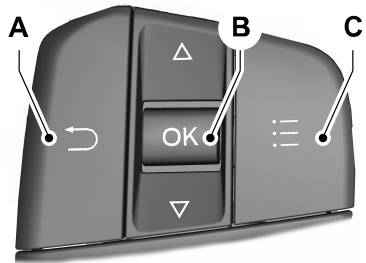

- A Return button.
- B OK button.
- C Menu button.

Return Button

Use the return button to go back or to exit.

OK Button

Use the **OK** button to make a selection. You can also use it to scroll through a menu.

Menu Button

Use the menu button on the main screen to display the submenu.

4 Inch Display Menu



This icon shows the features on or off status. A check in the box indicates the feature is on, and unchecked indicates the feature is off.

Note: Some options may appear different or not at all if the items are optional.

Note: Some MyKey menu options only appear if MyKey is enabled and at least one MyKey is programmed.

Information Displays

Trip Menu

Trip Menu	
Trip 1	
Trip 2	
Reset Individual Values	Select Your Setting
Configure View	Select Your Setting

- Trip Odometer - Registers the distance traveled of individual journeys or the total distance since the function was last reset.
- Trip Timer - Registers the elapsed time of individual journeys or the total time since the function was last reset.
- Average Fuel - Indicates the average fuel consumption of individual journeys or the average fuel consumption since the function was last reset.
- Average Speed - Indicates the average vehicle speed of individual journeys or the average vehicle speed since the function was last reset.
- Distance to Empty - Indicates the approximate distance your vehicle can travel on the fuel remaining in the tank. Changes in driving pattern can cause the value to not only decrease but also increase or stay constant for periods of time.

Note: Hold **OK** to reset fuel history and average fuel economy.

MyView

MyView
Digital Speedometer
Fuel Economy
Trip/Audio
Calm Screen

Navigation

Navigation
Menu options covered in the SYNC chapter. See General Information (page 427).

Information Displays

Audio

Audio
Menu options covered in the SYNC chapter. See General Information (page 427).

Phone

Phone
Menu options covered in the SYNC chapter. See General Information (page 427).

Settings

Settings		
Information	Contains vehicle status information. Select Your Setting.	
Display	Language	Select Your Setting
	Measure unit	
	Temperature unit	
	Tire Pressure	
Driver Assistance	Select Your Setting	
Vehicle Maintenance	Oil Level	Select Your Setting
	Oil Life	
	Brake Fluid Life	
	Tire Pressure	
MyKey	MyKey Info	
	Create MyKey	

Note: Additional vehicle settings are available through your touchscreen. See **Settings** (page 458).

PERSONALIZED SETTINGS

Select one of these options to display on your main screen.

Information Displays

Note: Some options may appear slightly different or not at all if the items are optional.

Select Screens
Calm Screen
Fuel Economy
Trip 1
Trip 2
This Trip ¹
EV Coach ¹
Tire Pressure
Intelligent AWD
Off Road
Trailer Light Check
Seatbelts
Auto StartStop ²
Now Playing

¹Hybrid only

²Non-hybrid only

After making your selection:

1. Select a setting and press the **OK** button. This can offer more information on some features.

Note: Hold **OK** to reset fuel history and average fuel economy.

Fuel Economy

An Instant Fuel Economy gauge is provided along with average fuel economy. Average fuel economy is continuously averaged since the last reset.

Hybrid features:

- When the gasoline engine is off the instant fuel economy gauge is replaced with an electric driving message.

Note: Hold **OK** to reset fuel history and average fuel economy.

Trip 1 and 2

Provides trip timer, trip average fuel economy and total trip distance traveled. For hybrid vehicles, the trip also shows the distance traveled on electric power only.

Information Displays

Hybrid Information (If Equipped)

This Trip

Provides trip timer, trip average fuel economy, total trip distance traveled, and distance traveled on electric power only with the engine off. If the gasoline engine has not turned on during the trip then trip average fuel economy is not shown. This Trip automatically resets each time you start your vehicle.

EV Coach

EV Coach can help you to get the most out of your vehicle's electric driving and regenerative braking capabilities.

When you are accelerating or maintaining speed you will see a blue or white solid bar indicating vehicle power. You may also see a blue rectangular box which shows the power level at which the engine will turn on.

- When your power level is within the box the color of the bar will be blue. This means you are in Electric operation and the engine is off.
- When your power level is outside of the box the color of the bar will be white. This means you are in Hybrid operation with a combination of the electric motor and the engine providing vehicle power.

When you are decelerating with either your foot off the accelerator pedal or on the brake pedal you will see a green or white solid bar indicating the power being used to slow down the vehicle. You may also see a green rectangular box which shows the amount of power that can be recaptured by the regenerative braking system and returned to the high voltage battery.

- When your power level is completely within the box the color of the bar will be all green. This means that the regenerative braking system is being used to efficiently slow the vehicle down and return the maximum percentage of energy to the high voltage battery.
- When your power level is outside of the green box then the bar will be white. This means that both the regenerative braking system and conventional braking system are being used.

INFORMATION MESSAGES

Note: Depending on your vehicle options and instrument cluster type, not all of the messages display or are available. Certain messages may be abbreviated or shortened depending upon which cluster type you have.



E222314

Press the **OK** button to acknowledge and remove some messages from the information display. Other message will be removed automatically after a short time.

Certain messages need to be confirmed before you can access the menus.

Information Displays

Active Park

Message	Action
Active Park Fault	The system requires service. Have the system checked as soon as possible.

Adaptive Cruise Control

Message	Action
Adaptive Cruise Malfunction	A radar concern is preventing the adaptive cruise from engaging. See How Does Adaptive Cruise Control With Stop and Go Work (page 241).
Front Sensor Not Aligned	
Adaptive Cruise Not Available	Conditions exist such that the adaptive cruise cannot function properly. See How Does Adaptive Cruise Control With Stop and Go Work (page 241).
Adaptive Cruise Not Available Sensor Blocked See Manual	The radar is blocked because of poor radar visibility due to inclement weather, ice, mud or water in front of radar. You can typically clean the sensor to resolve. See How Does Adaptive Cruise Control With Stop and Go Work (page 241).
Normal Cruise Active Adaptive Braking Off	Displays when the system disables automatic braking.
Adaptive Cruise - Driver Resume Control	Displays when the system reinstates adaptive cruise control to you.
Adaptive Cruise Speed Too Low to Activate	Displays when the vehicle speed is too slow to activate the adaptive cruise.

Adaptive Headlamps

Message	Action
Check Headlamp System See Manual	Displays when the system detects a concern. Have the system checked as soon as possible.

Information Displays

AdvanceTrac™ and Traction Control

Message	Action
Service AdvanceTrac	The system detects a condition that requires service. Have the system checked as soon as possible.
AdvanceTrac Off	The status of the AdvanceTrac system after you switch it off.
AdvanceTrac On	The status of the AdvanceTrac system after you switch it on.
AdvanceTrac OFF in 4x4 LOW	The system is off while the vehicle is in 4x4 low.
AdvanceTrac SPORT MODE	The status of the AdvanceTrac sport mode after you switch it on.
Traction Control Off	The status of the traction control system after you switch it off.
Traction Control On	The status of the traction control system after you switch it on.

Alarm

Message	Action
Vehicle Alarm To Stop Alarm, Start Vehicle.	Alarm triggered due to unauthorized entry. See Anti-Theft Alarm (page 77).

Battery and Charging System (12 volt)

Message	Action
Check Charging System	The charging system needs servicing. If the warning stays on or continues to come on, have the system checked as soon as possible.
Charging System Service Soon	The charging system needs servicing. If the warning stays on or continues to come on have the system checked as soon as possible.
Charging System Service Now	The charging system needs servicing. Have the system checked as soon as possible.

Information Displays

Message	Action
Battery State of Charge Low	The battery management system determines that the 12V battery is at a low state of charge. Start the engine to charge the battery or charge the battery using an aftermarket battery charger. This message clears once you restart your vehicle and the battery state of charge has recovered.
Turn Power Off To Save Battery	The battery management system determines that the battery is at a low state of charge. Turn the ignition off as soon as possible to protect the battery. This message will clear once the vehicle has been started and the battery state of charge has recovered. Turning off unnecessary electrical loads will allow faster battery state-of-charge recovery.
Low Battery Features Temporarily Turned Off	Displays when the battery management system detects an extended low-voltage condition. Various vehicle features will be disabled to help preserve the battery. Turn off as many of the electrical loads as soon as possible to improve system voltage. If the system voltage has recovered, the disabled features will operate again as normal.

Battery and Charging System (High Voltage)

Message	Action
Stop Safely Now	Displays when the stop safety hazard warning lamp is illuminated. This indicates an electrical component that requires service. This causes the vehicle to shut down or enter into limited operating mode.

Blind Spot Information and Cross Traffic Alert System

Message	Action
Blind Spot System Fault	A system error has occurred. Have the system checked as soon as possible.
Blind Spot Not Available Sensor Blocked See Manual	The system sensors are blocked. See Blind Spot Information System (page 259).
Cross Traffic Alert Applying Brakes	The system detects a vehicle and automatically applied the brakes.

Information Displays

Message	Action
Cross Traffic Not Available Sensor Blocked See Manual	The blind spot information system and cross traffic alert system sensors are blocked. See Cross Traffic Alert (page 263).
Cross Traffic System Fault	A system error has occurred. Have the system checked as soon as possible.
Cross Traffic Alert Deactivated Trailer Attached	The system automatically turns off and displays this message when you connect a trailer to the vehicle that does not have a trailer blind spot system or when you switch the trailer blind spot system off through the information display. See Cross Traffic Alert (page 263).
Blind Spot Alert Deactivated Trailer Attached	The system automatically turns off and displays this message when you connect a trailer to the vehicle that does not have a trailer blind spot system or when you switch the trailer blind spot system off through the information display. See Blind Spot Information System (page 259).

Doors and Locks

Message	Action
Driver Door Ajar	The driver door is not completely closed.
Passenger Door Ajar	The passenger door is not completely closed.
Rear Left Door Ajar	The rear left door is not completely closed.
Rear Right Door Ajar	The rear right door is not completely closed.
Liftgate Ajar	The liftgate is not completely closed.
Hood Ajar	The hood is not completely closed.
Switches Inhibited Security Mode	The system has disabled the door switches.
Doors Locked Unlock Before Opening	Displays when the door lock is turned on and you attempt to open the door.

Information Displays

Message	Action
Driver Door Fault Use Inside Override Lever In Map Pocket	Indicates a driver door fault that requires manually opening the door by the override lever. Have the system checked as soon as possible.
Door Fault Service Required	Indicates a fault with the electronic door system. Have the system checked as soon as possible.
Child Lock Malfunction Service Required	There is a system malfunction with the child locks. Have the system checked as soon as possible.
Child Lock ON	Indicates that the rear seat interior door release switches and power windows are switched off, preventing rear seat occupants from opening the doors or windows.
Child Lock OFF	Indicates that the rear seat interior door release switches and power windows are switched on, allowing the rear seat occupants to open the doors and windows.
Factory Keypad Code {X X X X X}	The factory keypad code displays in the information display after the system resets the keypad. See Passive Anti-Theft System (page 77).

Driver Alert

Message	Action
Driver Alert Warning Rest Now	Stop and rest as soon as it is safe to do so.
Driver Alert Warning Rest Suggested	Take a rest soon.

Fuel

Message	Action
Fuel Level Low	An early reminder of a low fuel condition.
Check Fuel Fill Inlet	The fuel fill inlet may not be properly closed.
Fuel Door Opening	Wait for up to 15 seconds while the fuel system depressurizes.

Information Displays

Message	Action
Fuel Door Open	The fuel system has finished depressurizing and you can begin to refuel.
Close Fuel Door to Avoid ""Check Engine"" Light	A reminder to close the fuel door. Failure to follow this instruction can cause the check engine light to illuminate.
Refuel Error See Manual	There is an error in attempting to refill your vehicle.

Hill Descent Control

Message	Action
Hill Descent Control OFF	Displays when you deactivate hill descent control mode.
For Hill Descent Reduce Speed 20 MPH or Less	Displays when hill descent speed exceeds 20 mph (32 km/h).
For Hill Descent Reduce Speed 32 Km/h or Less	Displays when hill descent speed exceeds 20 mph (32 km/h).
For Hill Descent Select Gear	Displays when hill descent control mode requires you to shift the transmission into gear.
Hill Descent Driver Resume Control	Displays when the hill control mode requires you to resume control.
Hill Descent Control Fault	Displays when a hill descent system fault is present.
Hill Descent Control Off System Cooling	Displays when you disable the hill descent control mode to cool the brake system.
Hill Descent Control Ready	Displays when hill descent control mode is ready.
Hill Descent Control Active	Displays when you activate the hill descent control mode.

Information Displays

Hill Start Assist

Message	Action
Hill Start Assist Not Available	Hill start assist is not available. Have the system checked as soon as possible. See Hill Start Assist (page 213).

Keys and Intelligent Access

Message	Action
To START Press Brake	A reminder to press the brake while starting your vehicle.
No Key Detected	The key is not detected by the system.
Restart Now or Key is Needed	The Start Stop button is pressed to shut off the engine and an Intelligent Access key is not detected inside your vehicle.
Full Accessory Power Active	Your vehicle is in the accessory ignition state.
Starting System Fault	There is a problem with your vehicle's starting system. Have the system checked as soon as possible.
Key Program Successful	During spare key programming, an intelligent access key is programmed to the system.
Max Number of Keys Learned	During spare key programming, the maximum number of keys have been programmed.
Key Program Failure	Displays during spare key programming, when intelligent access key programming fails.
Not Enough Keys Learned	Displays during spare key programming when you have not programmed enough keys.
Key Battery Low Replace Soon	Displays when the key battery is low. Change the battery as soon as possible.
Vehicle Switched Off	Displays when you switch the vehicle off.
Vehicle is ON	Informs you that upon exiting your vehicle that the vehicle is still on.

Information Displays

Lane Keeping System

Message	Action
Lane Keeping Sys. Malfunction Service Required	The system has malfunctioned. Have the system checked as soon as possible.
Front Camera Temporarily Not Available	The system has detected a condition that has caused the system to be temporarily unavailable.
Front Camera Low Visibility Clean Screen	The system has detected a condition that requires the windshield to be cleaned to operate properly.
Front Camera Malfunction Service Required	The system has malfunctioned. Have the system checked as soon as possible.
Keep Hands on Steering Wheel	The system requests the driver to keep their hands on the steering wheel.

Maintenance

Message	Action
Low Engine Oil Pressure	Stop your vehicle as soon as safely possible and turn off the engine. Check the oil level. If the warning stays on or continues to come on with your engine running, have the system checked as soon as possible.
Change Engine Oil Soon	The engine oil life is low and needs to be changed soon.
Oil Change Required	The engine oil life is low and needs to be changed immediately.
Brake Fluid Level Low	The brake fluid level is low and the brake system should be inspected immediately. See Brake Fluid Check (page 328).
Check Brake System	The brake system needs servicing. Stop the vehicle in a safe place. Contact an authorized dealer.
Engine Coolant Over Temperature	The engine coolant temperature is excessively high.
Washer Fluid Level Low	The washer fluid is low and needs to be refilled.

Information Displays

Message	Action
Transport Mode Contact Dealer	Indicates that your vehicle is still in Transport mode. This may not allow some features to operate properly. Have the system checked as soon as possible.
Factory Mode Contact Dealer	Indicates that your vehicle is still in Factory mode. This may not allow some features to operate properly. Have the system checked as soon as possible.
See Manual	Informs the driver that the powertrain needs service due to a powertrain malfunction.
Power Reduced to Lower Engine Temp	The engine has reduced power to help reduce high engine temperature.
Brake Applied Power Reduced	The brake system has reduced stopping power.

MyKey

Message	Action
MyKey not Created	You cannot program a MyKey.
MyKey Active Drive Safely	MyKey is active.
Speed Limited to {avg speed XXXX} km/h	When switching on your vehicle and MyKey is in use, displays that the MyKey speed limit is on.
Near Vehicle Top Speed	MyKey is in use and the MyKey speed limit is on and the vehicle speed is approaching 81 mph (130 km/h).
Vehicle at Top Speed of MyKey Setting	You have reached the speed limit set for your MyKey.
Check Speed Drive Safely	You have an active MyKey with a programmed set speed limit.
Buckle Up to Unmute Audio	Belt-Minder turns on with a MyKey in use.
AdvanceTrac On - MyKey Setting	With a MyKey in use, AdvanceTrac turns on.

Information Displays

Message	Action
Traction Control On - MyKey Setting	With a MyKey in use, traction control turns on.
MyKey Park Aid Cannot be Deactivated	With a MyKey in use, park aid is always on.
Lane Keeping Alert On MyKey Setting	With a MyKey in use, lane keeping alert turns on.

Park Aid

Message	Action
Check Front Park Aid	The system detects a fault that requires service. Have your vehicle checked as soon as possible.
Check Rear Park Aid	The system detects a fault that requires service. Have your vehicle checked as soon as possible.
Rear Park Aid Not Available Sensor Blocked See Manual	The radar is blocked due to bad weather, ice, mud or water in front of radar. You can typically clean the sensor to resolve. See Rear Parking Aid (page 225).
Front Park Aid Not Available Sensor Blocked See Manual	The radar is blocked due to bad weather, ice, mud or water in front of radar. You can typically clean the sensor to resolve. See Front Parking Aid (page 227).
Park Aid Not Available Sensor Blocked See Manual	The radar is blocked due to bad weather, ice, mud or water in front of radar. You can typically clean the sensor to resolve. See Principle of Operation (page 225).
Front Park Aid On Off	Displays the park aid status.
Rear Park Aid On Off	Displays the park aid status.

Information Displays

Park Brake

Message	Action
Park Brake Engaged	The parking brake is set, the engine is running and you drive your vehicle more than 3 mph (5 km/h). If the warning stays on after the parking brake is released, contact an authorized dealer as soon as possible.
To Release: Press Brake and Switch	The electric parking brake is set and a manual release is attempted without the brake pedal being pressed.
Park Brake Use Switch to Release	The electric parking brake is set and an automatic release is attempted but cannot be performed. Perform a manual release.
Release Park Brake	The electric parking brake is set and your vehicle speed exceeds 3 mph (5 km/h). Release park brake before continued driving.
Park Brake Not Applied	The electric parking brake is not fully applied.
Park Brake Not Released	The electric parking brake is not fully released.
Park Brake Maintenance Mode	The electric parking brake system has been put into a special mode that is used to allow service of the rear brakes. Have the system checked as soon as possible.
Park Brake Limited Function Service Required	The electric park brake system has detected a condition that requires service. Some functionality may still be available. Have the system checked as soon as possible.
Park Brake Malfunction Service Now	The electric parking brake system has detected a condition that requires service. Have the system checked as soon as possible.
Park Brake System Overheated	Numerous park brake applies have overheated the system. Wait 2 minutes before attempting to apply again.

Information Displays

Power Steering

Message	Action
Steering Fault Service Now	The power steering system has detected a condition that requires service. Have the system checked as soon as possible.
Steering Loss Stop Safely	The power steering system is not working. Stop your vehicle in a safe place. Have the system checked as soon as possible.
Steering Assist Fault Service Required	The power steering system has detected a condition within the power steering system or passive entry or passive start system that requires service. Have the system checked as soon as possible.
Steering Lock Malfunction Service Now	The steering lock system has detected a condition that requires service. Have the system checked as soon as possible.

Pre-Collision Assist

Message	Action
Pre-Collision Assist Not Available Sensor Blocked	You have a blocked sensor due to inclement weather, ice, mud or water in front of the radar sensor. You can typically clean the sensor to resolve.
Pre-Collision Assist Not Available	A fault with the system has occurred. Have the system checked as soon as possible.

Remote Start

Message	Action
To Drive: Press Brake and Gear Shift Button	Displays as a reminder to apply the brake and push the gear shift button to drive the vehicle after a remote start.

Information Displays

Seats

Message	Action
Occupant Sensor BLOCKED Remove Objects Near Passenger Seat	Objects are by the passenger seat. After the objects are moved away from the seat, if the warning stays on or continues to come on have the system checked as soon as possible.
Memory Recall Not Permitted While Driving	Displays as a reminder that memory seats are not available while driving.
Memory X Saved	Displays to show where your memory setting has been saved.

Starting System

Message	Action
To START Press Brake	Displays when starting the vehicle as a reminder to apply the brake.
Cranking Time Exceeded	Displays when the starter has exceeded its cranking time in attempting to start the vehicle.
Engine Start Pending Please Wait	Displays when the starter is attempting to start the vehicle.
Pending Start Cancelled	Displays when the pending start has been cancelled.

Information Displays

Tire Pressure Monitoring System

Message	Action
Tire Pressure Low	One or more tires on your vehicle have low tire pressure. See Tire Pressure Monitoring System (page 364).
Tire Pressure Monitor Fault	The tire pressure monitoring system is malfunctioning. If the warning stays on or continues to come on, have the system checked as soon as possible. See Tire Pressure Monitoring System (page 364).
Tire Pressure Sensor Fault	A tire pressure sensor is malfunctioning, or your spare tire is in use. For more information on how the system operates under these conditions, See Tire Pressure Monitoring System (page 364). If the warning stays on or continues to come on, have the system checked as soon as possible.

Trailer

Message	Action
Trailer Connected	A correct trailer connection is sensed during a given ignition cycle.
Trailer Disconnected	A trailer connection becomes disconnected, either intentionally or unintentionally, and has been sensed during a given ignition cycle.
Trailer Sway Reduce Speed	The trailer sway control has detected trailer sway.
Trailer Wiring Fault	There are certain faults in your vehicle wiring and trailer wiring/brake system. See Towing a Trailer (page 283).
Trailer Left Turn Lamps Fault Check Lamps	There is a fault with your trailer turn lamp. Check your lamp.
Trailer Right Turn Lamps Fault Check Lamps	There is a fault with your trailer turn lamp. Check your lamp.
Trailer Battery Not Charging See Manual	There is a fault with your trailer battery. See Towing a Trailer (page 283).
Trailer Lighting Module Fault See Manual	There is a fault with your vehicle trailer lighting module. See Towing a Trailer (page 283).

Information Displays

Transmission

Message	Action
Shift to Park	You switched the engine off and shift select lever is in any position other than park (P).
Transmission Warming Up Please Wait	Transmission is too cold. Wait for it to warm up before you drive.
Press Brake Pedal	Displays when the brake pedal needs to be depressed.
Transmission Over Temperature Stop Safely	The transmission is overheating and needs to cool. Stop in a safe place as soon as it's possible.
Transmission Service Required	Have the system checked as soon as possible.
Transmission Too Hot Press Brake	The transmission is overheating and needs to cool. Stop in a safe place as soon as it's possible.
Transmission Limited Function See Manual	The transmission has limited functionality. Have the system checked as soon as possible.
Transmission Not in Park	A reminder to shift into park. In addition, this message is typical after reconnecting or recharging the battery until you cycle the ignition to the on mode. See Changing the 12V Battery (page 329).
SHIFT SYS FAULT Confirm Park Brake Apply Before Exiting the Vehicle	Displays when there is a system fault and the park brake needs to be depressed before exiting the vehicle. Have the system checked as soon as possible.
SHIFT SYS FAULT Service Required	Have the system checked as soon as possible.
SHIFT SYS FAULT Vehicle is Shifting to Park	Displays when there is a system fault while the vehicle is shifting to park. Have the system checked as soon as possible.
SHIFT SYS FAULT Reverse Unavailable Service Required	Displays when there is a system fault while the vehicle is shifting to reverse. Have the system checked as soon as possible.

Information Displays

Message	Action
SHIFT SYS FAULT Drive Unavailable Select S for Drive Service Required	Have the system checked as soon as possible.
SHIFT SYS FAULT Neutral Unavail- able Service Required	Have the system checked as soon as possible.
SHIFT SYS FAULT Sport Unavailable Service Required	Have the system checked as soon as possible.
Invalid Gear Selec- tion	Displays when an invalid gear has been selected.
Depress Brake to Shift from Park	Displays when the brake pedal needs to be depressed to enable the transmission to shift from park.
Neutral Tow Engaged Turn Igni- tion Off for Towing	Reminder to switch off the ignition while in neutral tow.
Neutral Tow Engaged Depress Brake and Select Park to Exit Neutral Tow	Displays when neutral hold is active and you want to exit neutral tow.
Neutral Tow Remove Park Brake for Towing	Reminder to remove park brake while in neutral tow.
Neutral Tow Disengaged	Displays when the neutral tow is off.
Neutral Tow Enabled Leave Transmission in Neutral	Displays when neutral tow is on.

Information Displays

4WD

Message	Action
4WD Temporarily Disabled	The four wheel drive system has automatically disabled itself due to the system overheating.
4WD Temporarily Locked	The four wheel drive system is locking up the torque transfer clutch to help reduce clutch temperature.
4WD Off	Displays when the system automatically disables to protect itself. This may be caused by operating the vehicle with a mini spare tire installed, if the system detects dissimilar size tires, or if there is an issue with another vehicle system preventing 4WD operation. The system resumes normal operation and clears this message after you cycle the ignition on and off and drive a short distance with the road tire re-installed or after the other vehicle system issues are resolved.
4WD Restored	Displays after the system cools and the four wheel drive system resumes normal function.
4WD Fault Service Required	The four wheel drive system is not operating properly and the powertrain fault indicator illuminates. If the warning stays illuminated or continues to illuminate, contact an authorized dealer as soon as possible.
Change 4WD Power Transfer Unit Lube	Displayed when the transfer case fluid requires service.
4WD Power Transfer Unit Lube Set to New	Displayed when the transfer case fluid has been changed and reset to new.

Climate Control

AUTOMATIC CLIMATE CONTROL



E286493

Note: Depending on your vehicle option package, the controls may look different from what you see here.

Note: You can switch temperature units between Fahrenheit and Celsius.

Note: You can control some of the climate features through the touchscreen.

Note: For Hybrid Electric Vehicles and Plug-In Hybrid Electric Vehicles, the air conditioning compressor may run, and you may feel airflow when the climate control is off to provide cooling to the battery.

Accessing the Air Distribution Controls



Press and release the button to activate the selection screen.

From the screen, switch directed air from the windshield, instrument panel or footwell vents on or off. You can direct air through any combination of these vents. See **Climate** (page 445).

Accessing the Menu



Press and release the button to access different climate features.

Smart Zone - Hybrid Electric Vehicle (HEV), Plug-In Hybrid Electric Vehicle (PHEV)

If there is not an occupant in the front passenger seat, the climate control system may default to single zone to improve fuel economy, if you were previously in dual zone operation. When this occurs, dual zone turns off and the passenger set point changes to match the driver set point.

Press the dual zone button on the touchscreen or adjust the passenger set point to use dual zone operation without a passenger present. The system remains in dual zone operation until you switch the vehicle off.

You can disable or re-enable the Smart Zone feature by pressing and holding the dual zone button on the touchscreen. Both set point displays begin flashing to signify when the feature disables. The system returns to previous state after you release the dual zone button.

Accessing Rear Climate Controls



Press and release the button to access additional controls for the rear climate system.

Setting the Blower Motor Speed



Press and release + or - to adjust the volume of air circulated in the vehicle.

Climate Control

Setting the Temperature



Press the toggle button on the left-hand side of the climate control upward or downward to set the left-hand temperature.

Note: *This control also adjusts the right-hand side temperature when you switch off dual zone mode.*

Press the toggle button on the right-hand side of the climate control upward or downward to set the right-hand temperature.

Switching Auto Mode On and Off



Press and release the button to switch on automatic operation. Repeatedly press the button to adjust auto mode.

The system adjusts the blower motor speed, air distribution, air conditioning operation, and outside or recirculated air to reach and maintain the temperature you have set.

Under high humidity conditions, the system adjusts the blower motor speed, air distribution and air conditioning operation to reduce window fogging.

Note: *The system starts at the previous setting when you switch on **AUTO** mode.*

Note: *You can also switch off dual zone mode by pressing and holding the button for more than two seconds.*

Auto Mode Indicator Status

Auto Mode Indicator Status	Description
One indicator illuminated.	<ul style="list-style-type: none">• The blower motor speed is reduced.<ul style="list-style-type: none">• Use this setting to minimize the amount of noise from the blower motor.• This setting increases the time taken to cool the interior.
Two indicators illuminated.	<ul style="list-style-type: none">• The blower motor speed is moderate.
Three indicators illuminated.	<ul style="list-style-type: none">• The blower motor speed is increased.<ul style="list-style-type: none">• Use this setting to reduce the time taken to cool the interior.• This setting increases the amount of noise from the blower motor.

Climate Control

Switching the Air Conditioning On and Off



Press and release the button.

Use air conditioning with recirculated air to improve cooling performance and efficiency.

Note: In certain conditions, for example, maximum defrost, the air conditioning compressor may continue to operate even though you switch off the air conditioning.

Note: The A/C LED light may turn on and off based on the temperature setting or the current conditions.

Switching the Climate Control On and Off



Press and release the button.

Switching Maximum Air Conditioning On and Off



Press and release the button for maximum cooling.

The driver and passenger temperatures are set to LO, recirculated air flows through the instrument panel air vents, air conditioning turns on and the blower motor adjusts to the highest speed.

Switching Maximum Defrost On and Off



Press and release the button for maximum defrosting.

The driver and passenger temperatures are set to HI, air flows through the windshield air vents, and the blower motor adjusts to the highest speed.

Note: Depending on your region, air conditioning turns on.

You can also use this setting to defog and clear the windshield of a thin covering of ice.

Note: To prevent window fogging, you cannot select recirculated air when maximum defrost is on.

Note: The heated rear window also turns on when you select maximum defrost.

Switching Recirculated Air On and Off



Press and release the button to switch between outside air and recirculated air.

The air currently in the passenger compartment recirculates. This may reduce the time needed to cool the interior, when used with A/C, and reduce unwanted odors from entering your vehicle.

Note: Recirculated air may turn off automatically, or prevent you from switching on in all air flow modes except MAX A/C to reduce the risk of fogging. Recirculation may also turn on and off automatically in various air distribution control combinations to improve heating or cooling efficiency.

HINTS ON CONTROLLING THE INTERIOR CLIMATE

General Hints

Note: Prolonged use of recirculated air may cause the windows to fog up.

Note: You may feel a small amount of air from the footwell air vents regardless of the air distribution setting.

Note: To reduce humidity build-up inside your vehicle, do not drive with the system switched off or with recirculated air always switched on.

Climate Control

Note: Do not place objects under the front seats as this may interfere with the airflow to the rear seats.

Note: Remove any snow, ice or leaves from the air intake area at the base of the windshield.

Note: To improve the time to reach a comfortable temperature in hot weather, drive with the windows open until you feel cold air through the air vents.

Automatic Climate Control

Note: Adjusting the settings when your vehicle interior is extremely hot or cold is not necessary. Automatic mode is best recommended to maintain set temperature.

Note: The system adjusts to heat or cool the interior to the temperature you select as quickly as possible.

Note: For the system to function efficiently, the instrument panel and side air vents should be fully open.

Note: If you select **AUTO** during cold outside temperatures, the system directs air flow to the windshield and side window air vents. In addition, the blower motor may run at a slower speed until the engine warms up.

Note: If you select **AUTO** during hot temperatures and the inside of the vehicle is hot, the system uses recirculated air to maximize interior cooling. Blower motor speed may also reduce until the air cools.

Quickly Heating the Interior

1. Press and release **AUTO**.
2. Adjust the temperature function to the setting you prefer.

Recommended Settings for Heating

1. Press and release **AUTO**.

2. Adjust the temperature function to the setting you prefer. Use 72°F (22°C) as a starting point, then adjust the setting as necessary.

Quickly Cooling the Interior

1. Press and release **MAX A/C**.

Recommended Settings for Cooling

1. Press and release **AUTO**.
2. Adjust the temperature function to the setting you prefer. Use 72°F (22°C) as a starting point, then adjust the setting as necessary.

Defogging the Side Windows in Cold Weather

1. Press and release defrost or maximum defrost.
2. Adjust the temperature control to the setting you prefer. Use 72°F (22°C) as a starting point, then adjust the setting as necessary.

REAR PASSENGER CLIMATE CONTROLS (IF EQUIPPED)



Note: Depending on your vehicle option package, the controls may look different from what you see here.

Climate Control

Directing Air to the Overhead Air Vents



Press and release the button to direct airflow to the overhead air vents.

Directing Air to the Rear Footwell Air Vents



Press and release the button to direct airflow to rear footwell air vents.

Rear Climate Control Lock Indicator



When illuminated, you can only operate the rear passenger settings through the front controls.

Setting the Rear Blower Motor Speed

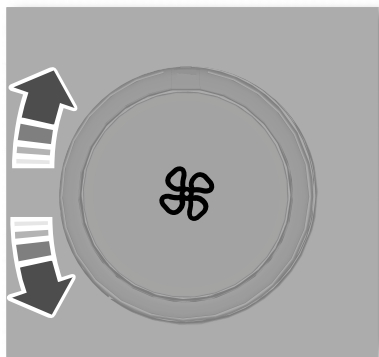

Turn the control to adjust the volume of air circulated in the rear passenger compartment.

Setting the Rear Temperature

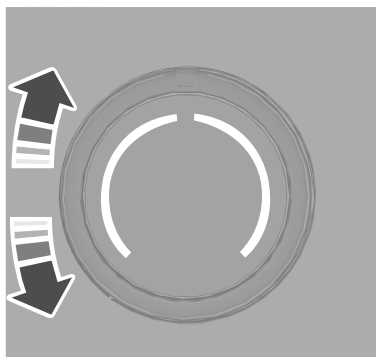

Turn the control to set the temperature in the rear passenger compartment.

Switching the Rear Climate Control On and Off



Press and release the button.

Switching the Rear Heated Seats On and Off (If Equipped)



See **Heated Seats** (page 156).

HEATED WINDSHIELD (IF EQUIPPED)

Windshield Wiper De-Icer



When you switch the heated rear window on, the windshield wiper de-icer turns on.

Climate Control

HEATED REAR WINDOW



Press the button to clear the rear window of thin ice and fog. The heated rear window turns off after a short period of time.

Note: Do not use harsh chemicals, razor blades or other sharp objects to clean or remove decals from the inside of the heated rear window. The vehicle warranty may not cover damage to the heated rear window grid lines.

HEATED EXTERIOR MIRRORS

(IF EQUIPPED)

When you switch the heated rear window on, the heated exterior mirrors turn on.

Note: Do not remove ice from the mirrors with a scraper or adjust the mirror glass when it is frozen in place.

Note: Do not clean the mirror housing or glass with harsh abrasives, fuel or other petroleum-based cleaning products. The vehicle warranty may not cover damage caused to the mirror housing or glass.

REMOTE START (IF EQUIPPED)

The climate control system adjusts the interior temperature during remote start.

You can switch this feature on or off and adjust the settings using the touchscreen. See **Settings** (page 458).

You cannot adjust the climate control setting during remote start operation. Switch the ignition on to make adjustments.

Based on your remote start settings, the following vehicle-dependent features may or may not remain on after remote starting your vehicle:

- Climate controlled seats.
- Heated steering wheel.
- Heated mirrors.
- Heated rear window.
- Windshield wiper de-icer.

Note: For dual zone climate controlled seats, the passenger seat setting defaults to match the driver seat during remote start.

Automatic Settings

If **Auto** is on, the system sets the interior temperature to 72°F (22°C) and heats or cools the vehicle interior as required to achieve comfort.

Note: In cold weather, the heated rear window and heated mirrors turn on.

Last Settings

If **Last Settings** is on, the system uses the settings last selected before you turned off the vehicle.

Heated and Cooled Features

In **Auto** mode, certain heated features may switch on during cold weather, and cooled features during hot weather.

Interior Air Quality

WHAT IS THE CABIN AIR FILTER

The cabin air filter improves the quality of air in your vehicle by trapping dust, pollen and other particles.

REPLACING THE CABIN AIR FILTER

Replace the filter at regular intervals. See **Scheduled Maintenance** (page 476).

The cabin air filter is behind the glove compartment.

To remove the lower glove compartment and access the filter:

1. Open the glove compartment.

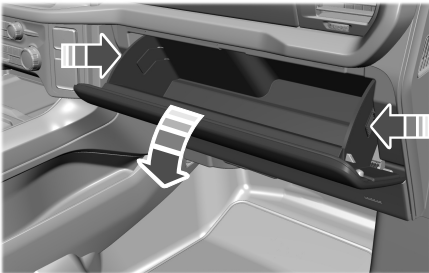

2. Press the tab on each side.
3. Fully lower the glove compartment.
4. Pull the glove compartment toward you.

Seats

SITTING IN THE CORRECT POSITION



WARNING: Sitting improperly, out of position or with the seatback reclined too far can take weight off the seat cushion and affect the decision of the passenger sensing system, resulting in serious injury or death in the event of a crash. Always sit upright against your seat back, with your feet on the floor.



WARNING: Do not recline the seat backrest too far as this can cause the occupant to slide under the seatbelt, resulting in personal injury in the event of a crash.



WARNING: Do not place objects higher than the top of the seat backrest. Failure to follow this instruction could result in personal injury or death in the event of a sudden stop or crash.

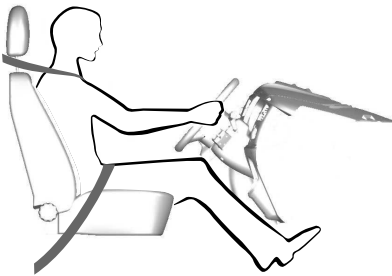

When you use them properly, the seat, head restraint, seatbelt and airbags will provide optimum protection in the event of a crash.

We recommend that you follow these guidelines:

- Sit in an upright position with the base of your spine as far back as possible.
- Do not recline the seat backrest so that your torso is more than 30 degrees from the upright position.
- Adjust the head restraint so that the top of it is level with the top of your head and as far forward as possible. Make sure that you remain comfortable.
- Keep sufficient distance between yourself and the steering wheel. We recommend a minimum of 10 in (25 cm) between your breastbone and the airbag cover.
- Hold the steering wheel with your arms slightly bent.
- Bend your legs slightly so that you can press the pedals fully.
- Position the shoulder strap of the seatbelt over the center of your shoulder and position the lap strap tightly across your hips.

Make sure that your driving position is comfortable and that you can maintain full control of your vehicle.

HEAD RESTRAINTS



WARNING: Fully adjust the head restraint before you sit in or operate your vehicle. This will help minimize the risk of neck injury in the event of a crash. Do not adjust the head restraint when your vehicle is moving.

Seats



WARNING: The head restraint is a safety device. Whenever possible it should be installed and properly adjusted when the seat is occupied. Failure to adjust the head restraint properly could reduce its effectiveness during certain impacts.

Note: Adjust the seat backrest to an upright driving position before adjusting the head restraint. Adjust the head restraint so that the top of it is level with the top of your head and as far forward as possible. Make sure that you remain comfortable. If you are extremely tall, adjust the head restraint to its highest position.

Adjusting the Head Restraints

Front Seat Head Restraints



The head restraints consist of:

- A An energy absorbing head restraint.
- B Two steel stems.
- C Guide sleeve adjust and release button.

Raising the Head Restraint

Pull the head restraint up.

Lowering the Head Restraint

1. Press and hold the C button.
2. Push the head restraint down.

Second Row Center Seat Head Restraint (If Equipped)

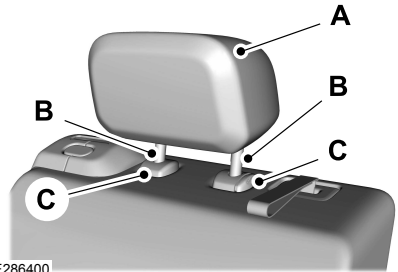

The head restraints consist of:

- A An energy absorbing head restraint.
- B Two steel stems.
- C Guide sleeve adjust and release buttons.

Removing the Head Restraint

1. Press and hold the C buttons.
2. Pull the head restraint up.

Installing the Head Restraint

Align the steel stems into the guide sleeves and push the head restraint down until it locks.

Seats

Second Row Outermost Seat Head Restraints

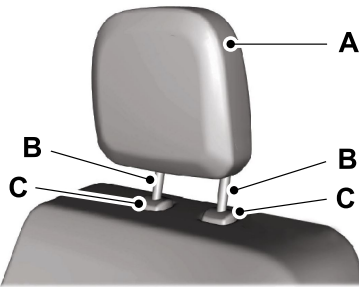

The head restraints consist of:

- A An energy absorbing head restraint.
- B Two steel stems.
- C Guide sleeve unlock and remove buttons.

Removing the Head Restraint

1. Press and hold the C buttons.
2. Pull the head restraint up.

Installing the Head Restraint

Align the steel stems into the guide sleeves and push the head restraint down until it locks.

Third Row Seat Head Restraints

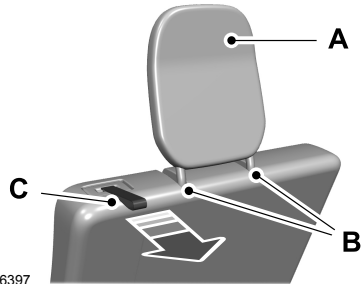

E286397

The head restraints consist of:

- A An energy absorbing head restraint.
- B Two steel stems.
- C Fold strap.

Folding the Head Restraint

Pull the fold strap (C). Pull the head restraint back up to reset.

Note: Press the stow or fold button on the power folding seats to fold the head restraint.

MANUAL SEATS (IF EQUIPPED)

Moving the Seat Backward and Forward



WARNING: Do not adjust the driver seat or seat backrest when your vehicle is moving. This may result in sudden seat movement, causing the loss of control of your vehicle.

Seats



WARNING: Make sure the seat fully locks into place by rocking it backward and forward. Not securing the seat into the locked position can be dangerous in a crash and could cause serious personal injury or death.

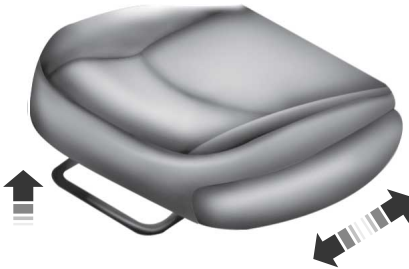

E190838

Adjusting the Seat Backrest



WARNING: Always drive and ride with your seatback upright and the lap belt snug and low across the hips.



WARNING: Do not place cargo or any objects behind the seat backrest before returning it to the original position. Pull on the seat backrest to make sure that it has fully latched after returning the seat backrest to its original position. An unlatched seat may become dangerous if you stop suddenly or have a crash.



E291151

POWER SEATS



WARNING: Do not adjust the driver seat or seat backrest when your vehicle is moving. This may result in sudden seat movement, causing the loss of control of your vehicle.



WARNING: Do not place cargo or any objects behind the seatback before returning it to the original position.

Seats

10-Way Seat Controls

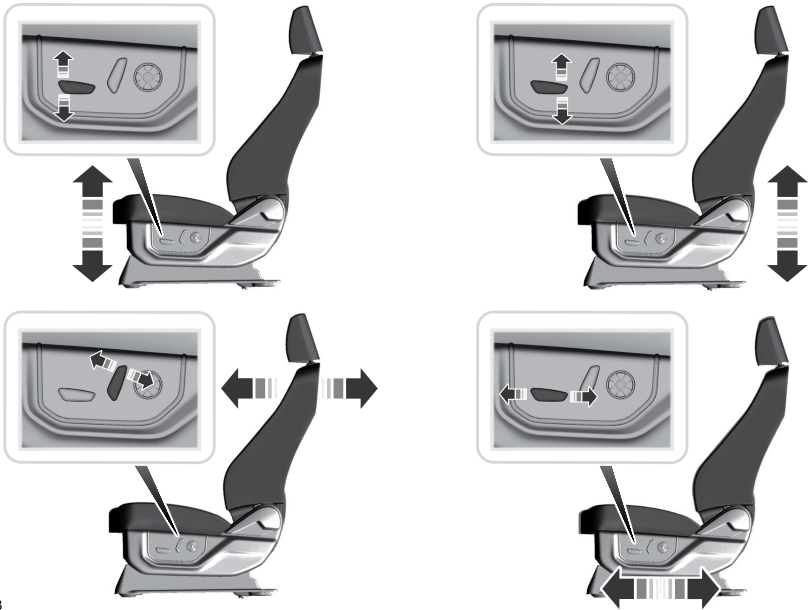

E176038

Adjusting the Lumbar Support (if Equipped)



Seats

8-Way Seat Controls

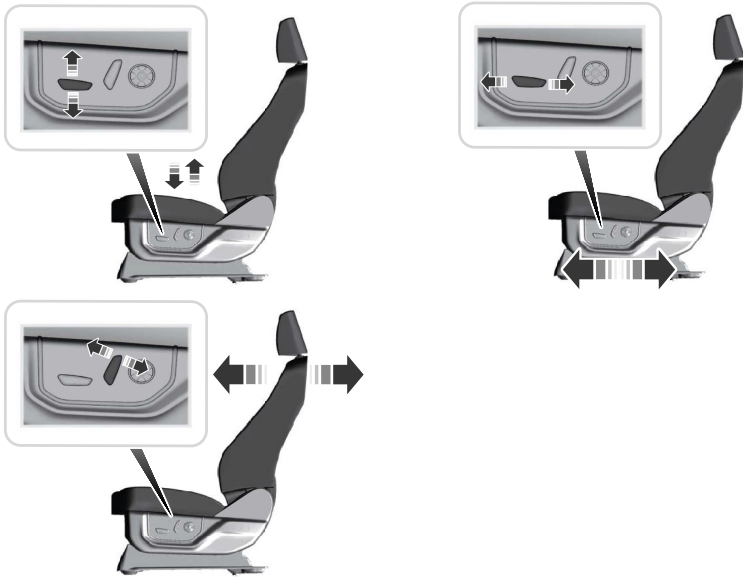

Adjusting the Multi-Contour Front Seats With Active Motion (If Equipped)

Note: The engine must be running or the vehicle must be in accessory mode to activate the seats.

Note: Allow a few seconds for any selection to activate. The seat backrest and cushion massage cannot function at the same time.

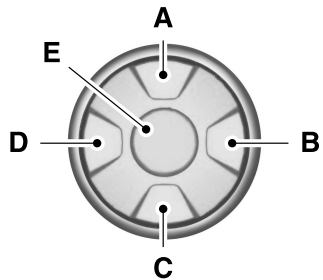

Seats

	Massage Mode	Lumbar and Bolster Mode
A	Back massage intensity adjustment	Upper lumbar
B	Massage intensity decrease and off*	Lumbar decrease
C	Cushion massage intensity adjustment	Lower lumbar**
D	Massage intensity increase	Lumbar increase
E	On and off	-

*The massage feature defaults to an alternating massage mode with back massage intensity adjustment. The lumbar and bolster feature defaults to the middle lumbar mode.

**Press C a second time to adjust the back bolster. Press C a third time to adjust the cushion bolster.

You can also adjust this feature through the touchscreen. When switched on, the system displays directions for you to adjust the lumbar settings in your seat or to set the massage function.

- Driver seat.
- Power mirrors.
- Optional power steering column.

The memory control is on the driver door.



MEMORY FUNCTION (IF EQUIPPED)



WARNING: Before activating the memory seat, make sure that the area immediately surrounding the seat is clear of obstructions and that all occupants are clear of moving parts.



WARNING: Do not use the memory function when your vehicle is moving.

This feature recalls the position of the following:

Saving a PreSet Position

1. Switch the ignition on.
2. Adjust the memory features to your preferred position.
3. Press and hold the preferred preset button until you hear a single tone.

You can save up to three preset memory positions. You can save a memory preset at any time.

Seats

Recalling a PreSet Position

Press and release the preset button associated with your preferred driving position. The memory features move to the position stored for that preset.

Note: *You can only recall a preset memory position when the ignition is off, or when the transmission is in park (P) or neutral (N) and the vehicle is not moving if the ignition is on.*

You can also recall a preset memory position by:

- Pressing the unlock button on your remote control if it is linked to a preset position.
- Unlocking the driver door handle if a linked remote control is present.

Note: *Using a linked remote control to recall your memory position when the ignition is off moves the seat to the Easy Entry position.*

Note: *Pressing any active memory feature adjustment control, or any memory button during a memory recall, cancels the operation.*

Linking a PreSet Position to your Remote Control

Your vehicle can save the preset memory positions for up to three remote controls.

1. With the ignition on, move the memory features to the preferred positions.
2. Press and hold the preferred preset button for about five seconds. A tone sounds after about two seconds. Continue holding until you hear a second tone.
3. Within three seconds, press the lock button on the remote control you are linking.

To unlink a remote control, follow the same procedure – except in step 3, press the unlock button on the remote control.

Note: *If more than one linked remote control or intelligent access key is in range, the memory function moves to the settings of the first key to recall a memory position.*

Easy Entry and Exit Feature

If you enable the easy entry and exit feature, it moves the driver seat position rearward up to 2 in (5 cm) when you switch the ignition off.

The driver seat returns to the previous position when you switch the ignition on.

You can enable or disable this feature through the touchscreen. See **Settings** (page 458).

REAR SEATS

Adjusting the Second Row Rear Seats



WARNING: Always drive and ride with your seatback upright and the lap belt snug and low across the hips.



WARNING: Do not recline the seat backrest too far as this can cause the occupant to slide under the seatbelt, resulting in personal injury in the event of a crash.

Seats

Adjusting the Seat Backrest

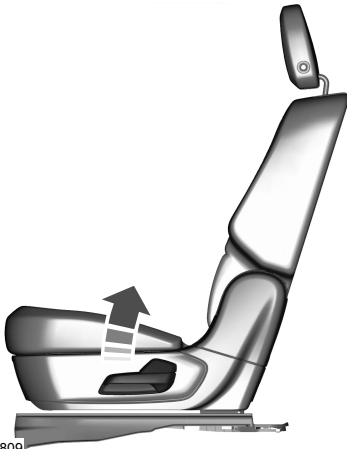

E281809

Lift the handle and adjust the seat backrest rearward or forward.

Folding the Seat Backrest Flat

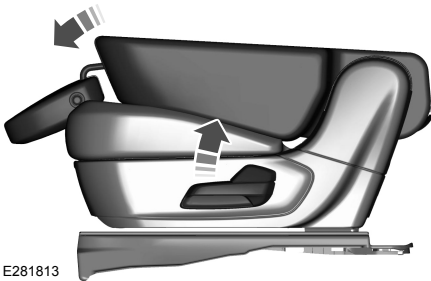

E281813

Lift the handle and fold the seat backrest forward until it is flat.

Note: For bench seats, make sure you unbuckle the center seatbelt before folding the seat backrest.

Moving the Seat Backward and Forward (If Equipped)



E190838

Adjusting the Second Row Seats for Easy Entry

⚠ WARNING: Do not drive your vehicle with a seat that is unlatched or in the folded position. Failure to follow this instruction could result in personal injury or death in the event of a sudden stop or crash.

⚠ WARNING: Do not place cargo or any objects behind the seat backrest before returning it to the original position. Pull on the seat backrest to make sure that it has fully latched after returning the seat backrest to its original position. An unlatched seat may become dangerous if you stop suddenly or have a crash.

⚠ WARNING: Do not adjust a seat or release a seat floor latch when the vehicle is moving. Failure to follow this instruction could result in personal injury or death in a sudden stop or crash.

Note: You may have to move the front row seat forward to allow the second row seat to be fully folded.

Seats

Note: You can move the second row outermost seats forward to allow access to the third row seats.

This feature allows for easier entry and exit to and from the third row seat.



E281814

1. Lift the handle on top of the seat backrest. The seat backrest folds forward and engages the seat track.

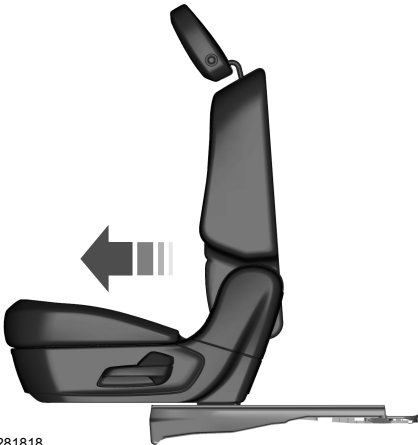

E281818

2. Push the seat forward.

3. To return the seat to the seating position, push the seat backrest and move the track rearward. Make sure the seat backrest locks in the upright position.

Adjusting the Second Row Seats with Power Easy Entry (If Equipped)

WARNING: Do not fold a seat if it is occupied. Failure to follow this instruction could result in personal injury.

The easy entry seat allows for easier entry and exit to and from the third row seat.

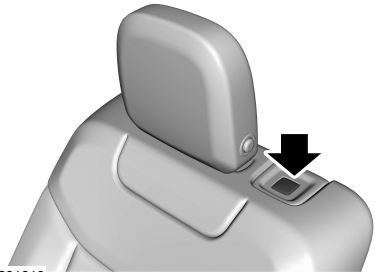

E281819

Press the button on top of the second row seat backrest to move the seat forward. This provides access to the third row.

Folding the Second Row Center Seat



E281821

Seats

Pull the strap to fold the seat backrest flat.

To return the seat to the upright position, rotate the seat backrest until it locks.

Adjusting the Second Row Outermost Seats

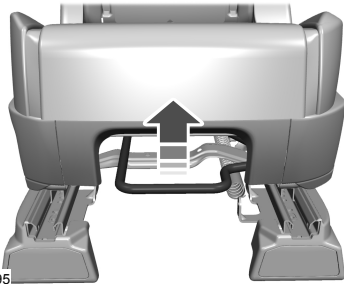

E286395

Lift the handle to move the seat forward or rearward.

Exiting the Third Row Seats

WARNING: Do not place cargo or any objects behind the seatback before returning it to the original position.

WARNING: Check under the seat cushion to make sure no cargo or objects are under the seat cushion before returning the seat cushion to its original position, and that the seat cushion locks into place. Failure to do so may prevent the seat from operating properly in the event of a crash, which could increase the risk of serious injury.

WARNING: Do not adjust a seat or release a seat floor latch when the vehicle is moving. Failure to follow this instruction could result in personal injury or death in a sudden stop or crash.

WARNING: Do not drive your vehicle with a seat that is unlatched or in the folded position. Failure to follow this instruction could result in personal injury or death in the event of a sudden stop or crash.

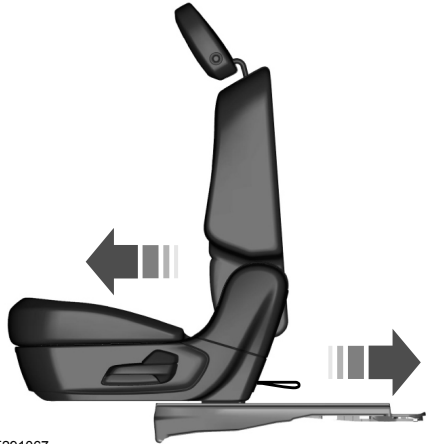

E291067

1. Pull the strap on the back of the second row seat. This moves the seat forward.
2. To return the seat to the seating position, push the seat backrest and move the track rearward. Make sure the seat backrest locks in the upright position.

Folding the Third Row Manual Seat

1. Remove all objects from the seat.

Seats

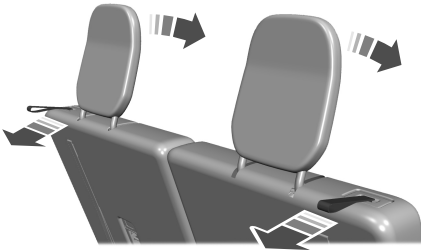

E286398

2. Fold the head restraints by pulling the head restraint release strap.
3. From the rear of the vehicle, fold the seat backrest by pulling and holding the strap while pushing the seat backrest forward. Release the strap once the seat backrest starts rotating forward.

Note: Do not use the seat anchors as cargo tie downs.

Note: Make sure that the area under the seat is free of objects before stowing it.

Unfolding the Third Row Manual Seat



WARNING: Do not place cargo or any objects behind the seat backrest before returning it to the original position. Pull on the seat backrest to make sure that it has fully latched after returning the seat backrest to its original position. An unlatched seat may become dangerous if you stop suddenly or have a crash.

Note: Make sure that there are no objects such as books, purses or briefcases on the load floor before unstowing the seat. Failure to remove all objects from the top of the load floor prior to unstowing it may cause damage to the seat.

Note: Make sure the area under the load floor is free of objects before unstowing it.

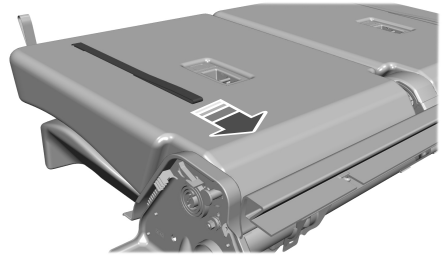

E286399

1. To return the seat backrest to the upright position, pull the long strap until the seat backrest locks.
2. Pull the head restraints up to their normal positions.

Adjusting the Third Row Power Seats

Note: The power rear seat functions disable 10 minutes after you switch the ignition off. The transmission must be in park (P) and the liftgate must be open to operate the seats.

The buttons are inside the liftgate area.

Seats

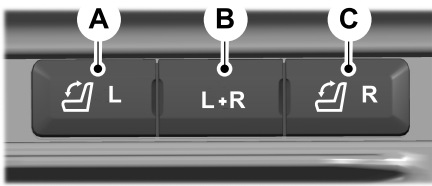

E291063

- A Press to fold the left-hand third row seat.
- B Press to fold and unfold both third row seats.
- C Press to fold the right-hand third row seat.

To return the third-row seat backrest to the original position, press the corresponding control again.

If the seats are inoperable, do the following:

1. Make sure that the engine is running and the tailgate is open.
2. Make sure that there are no objects on the seats that would prevent them from folding completely.
3. Press and hold button B for one minute until both seats completely fold and unfold.
4. Press button A and button C to confirm each seat is operational.

Note: During this procedure, the seat may appear to be fully unfolded. Continue holding the switch for a few seconds.

If the power rear seat disables after 10 minutes, you can enable the seat by:

- Opening any door.
- Pressing the unlock button on the key fob.
- Pressing any keyless entry keypad button.
- Switching the ignition on.

HEATED SEATS

WARNING: Use caution when using the heated seat if you are unable to feel pain to your skin because of advanced age, chronic illness, diabetes, spinal cord injury, medication, alcohol use, exhaustion or other physical conditions. The heated seat could cause burns even at low temperatures, especially if used for long periods of time. Failure to follow this instruction could result in personal injury.

WARNING: Do not poke sharp objects into the seat cushion or seat backrest. This could damage the heated seat element and cause it to overheat. Failure to follow this instruction could result in personal injury.

WARNING: Do not place anything on the seat that blocks the heat, for example a seat cover or a cushion. This could cause the seat to overheat. Failure to follow this instruction could result in personal injury.

Front Seats

Do not do the following:

- Place heavy objects on the seat.
- Operate the heated seat if water or any other liquid spills on the seat. Allow the seat to dry thoroughly.

Note: The engine must be running to use this feature.

Seats



Press the heated seat symbol to cycle through the various heat settings and off. More indicator lights indicate warmer settings.

Note: The heated seats switch on during a remote start if they are enabled.

Note: The heated seats may switch on when you start your vehicle if they were on when you previously switched your vehicle off.

Automatic Climate Controlled Seats (If Equipped)

When you switch on the auto setting, the seats switch between the heated seats and ventilated seats to match your climate control setting.

Second Row Heated Seats

The heated seat controls are on the rear of the center console.

VENTILATED SEATS (IF EQUIPPED)

Do not do the following:

- Spill liquid on the front seats. This may cause the air vent holes to become blocked and not work properly.
- Place cargo or objects under the seats. They may block the air intake causing the air vents to not work properly.

The engine must be running to use this feature.



Press this symbol to cycle through the various ventilation settings and off. More indicator lights indicate higher fan speeds.

Note: The ventilated seats switch on during a remote start if they are enabled.

Note: The ventilated seats may switch on when you start your vehicle if they were on when you previously switched your vehicle off.

If the engine falls below 350 RPM when the ventilated seats are on, the system turns off. You need to switch it back on.

Note: To improve comfort, use the ventilated seats along with the vehicle's air conditioning system.

Automatic Climate Controlled Seats (If Equipped)

When you switch on the auto setting, the seats switch between the heated seats and ventilated seats to match your climate control setting.

Rear Occupant Alert System

WHAT IS THE REAR OCCUPANT ALERT SYSTEM

The rear occupant alert system monitors vehicle conditions and notifies you to check for rear seat occupants when you switch the ignition off.

HOW DOES THE REAR OCCUPANT ALERT SYSTEM WORK

The system monitors when rear doors have been opened and closed to indicate the potential presence of an occupant in the rear seat.

A message displays in the information and entertainment display screen and an audible warning sounds when you switch the ignition off after any of the following conditions have been met:

- A rear door is opened or closed while the ignition is on.
- You switch the ignition on within 15 minutes of a rear door opening and closing.
- You switch the ignition on within 15 minutes of the alert having displayed or sounded.

REAR OCCUPANT ALERT SYSTEM PRECAUTIONS



WARNING: On hot days, the temperature inside the vehicle can rise very quickly. Exposure of people or animals to these high temperatures for even a short time can cause death or serious heat related injuries, including brain damage. Small children are particularly at risk.



WARNING: Do not leave children or pets unattended in your vehicle. Failure to follow this instruction could result in personal injury or death.

REAR OCCUPANT ALERT SYSTEM LIMITATIONS

The system does not detect the presence of objects or passengers in the rear seat. It monitors when rear doors are opened and closed.

Note: *It is possible to receive an alert when there is no rear seat occupant, but alert conditions are met.*

Note: *It is possible to receive no alert when there is an occupant in the rear seat, if alert conditions are not met. For example, if a rear seat occupant does not enter the vehicle through a rear door.*

Note: *The audible warning does not sound when the front door is opened before you switch the ignition off.*

SWITCHING REAR OCCUPANT ALERT SYSTEM ON AND OFF

1. Press **Settings** on the touchscreen.
2. Press **Vehicle**.
3. Switch **Rear Occupant Alert** on or off.

Note: *The default setting is on.*

Note: *Performing a master reset causes the system to switch on again.*

Semiannual Reminder (If Equipped)

When you switch the system off, a message appears every six months as a reminder that the system is off. You can switch the system back on or leave it off.

Rear Occupant Alert System

REAR OCCUPANT ALERT SYSTEM INDICATORS



Message
Check rear seats for occupants.

Displays when you switch your vehicle off after the alert conditions are met.

The message displays for a short period of time. Press **Close** to acknowledge and remove the message.

Note: Depending on your SYNC version, the graphic may look different from what you see here.

REAR OCCUPANT ALERT SYSTEM AUDIBLE WARNINGS

Sounds when you switch your vehicle off after the alert conditions are met.

The warning sounds for a short period of time.

Garage Door Opener (If Equipped)

WHAT IS THE GARAGE DOOR OPENER

HomeLink Wireless Control System



The universal garage door opener replaces the common hand-held garage door opener with a three-button transmitter integrated into the driver's sun visor.

HOW DOES THE GARAGE DOOR OPENER WORK

The system includes two primary features, a garage door opener and a platform for remote activation of devices within the home. You can program garage doors as well as entry gate operators, security systems, entry door locks and home or office lighting.

Additional system information can be found online at www.homelink.com or by calling the toll-free help line at 1-800-355-3515.

Note: You can program a maximum of three devices. To change or replace any of the three devices after it has been initially programmed, you must first erase the current settings. See **Clearing the Garage Door Opener** (page 162).

GARAGE DOOR OPENER PRECAUTIONS



WARNING: Do not use the system with any garage door opener that does not have the safety stop and reverse feature as required by U.S. Federal Safety Standards (this includes any garage door opener manufactured before April 1, 1982). A garage door opener which cannot detect an object, signaling the door to stop and reverse, does not meet current federal safety standards. Using a garage door opener without these features increases the risk of serious injury or death.

Note: Make sure that the garage door and security device are free from obstruction when you are programming. Do not program the system with your vehicle in the garage.

Note: Make sure you keep the original remote control transmitter for use in other vehicles as well as for future system programming.

Note: We recommend that upon the sale or lease termination of your vehicle, you erase the programmed function buttons for security reasons. See **Clearing the Garage Door Opener** (page 162).

GARAGE DOOR OPENER LIMITATIONS

Canadian radio-frequency laws require transmitter signals to time-out (or quit) after several seconds – which may not be long enough for HomeLink to pick up the signal.

U.S. gate operators time-out in the same manner.

Garage Door Opener (If Equipped)

Note: If programming a garage door opener or gate operator, it is advised to unplug the device during the “cycling” process to prevent possible overheating.

PROGRAMMING THE GARAGE DOOR OPENER TO YOUR HAND-HELD TRANSMITTER

This process is to program your in-vehicle HomeLink function button with your hand-held transmitter.

Note: The programming steps below assume you will be programming HomeLink that was not previously programmed. If your HomeLink was previously programmed, you may need to erase your HomeLink buttons. See **Clearing the Garage Door Opener** (page 162).

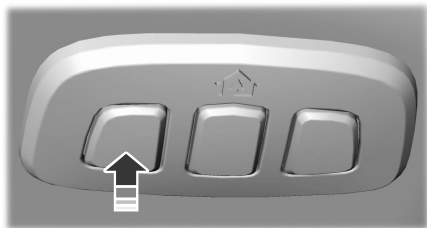

1. With your vehicle parked outside of the garage, switch your ignition to the on position, but do not start your vehicle.
2. Press and release one of the three HomeLink function buttons that you would like to program.
3. Hold your hand-held garage door transmitter 1–3 in (2–8 cm) away from the HomeLink button you want to program.

4. Press and hold the hand-held transmitter button you want to program while watching the indicator light on HomeLink. Continue to hold the hand-held button until the HomeLink indicator light flashes rapidly or is continuously on.

Note: You may need to use a different method if you live in Canada or have difficulties programming your gate operator or garage door opener. See **Programming the Garage Door Opener to Your Gate Opener Motor** (page 162).

5. Press and hold the HomeLink button you programmed for two seconds, then release. You may need to do this twice to activate the door.

Note: If the indicator light stays on, the programming is complete.

Note: If the HomeLink indicator flashes rapidly, repeat step 5.

Note: If your device still does not operate, you must program your garage door. See **Programming the Garage Door Opener to Your Garage Door Opener Motor** (page 161).

6. To program additional buttons, repeat Steps 1 – 4.

PROGRAMMING THE GARAGE DOOR OPENER TO YOUR GARAGE DOOR OPENER MOTOR



Garage Door Opener (If Equipped)

1. Press the learn button on the garage door opener motor, you have 30 seconds to complete the next two steps.
2. Return to your vehicle.

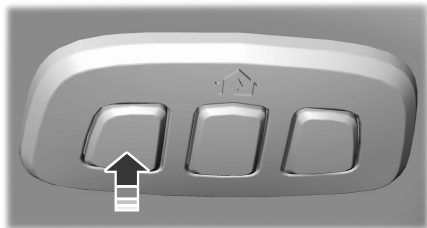

3. Press and hold one of the three HomeLink function buttons you want to program for two seconds, then release. Repeat this step. Depending on your brand of garage door opener, you may need to repeat this sequence a third time.

PROGRAMMING THE GARAGE DOOR OPENER TO YOUR GATE OPENER MOTOR

Gate Operator / Canadian Programming

Canadian radio-frequency laws require transmitter signals to “time-out” (or quit) after several seconds of transmission – which may not be long enough for HomeLink to pick up the signal during programming. Similar to this Canadian law, some U.S. gate operators “time-out” in the same manner.

Note: If programming a garage door opener or gate operator, it is advised to unplug the device during the “cycling” process to prevent possible overheating.

1. Press and release, every two seconds, your hand-held transmitter until the HomeLink indicator light changes to a rapidly blinking or continuously on light.
2. Release the hand-held transmitter button.
3. Press and hold the HomeLink function button you want to program for two seconds, then release. You may need to do this twice to activate the door.

Note: If the indicator light stays on, the programming is complete.

Note: If the HomeLink indicator flashes rapidly, repeat Step 3.

Note: If your device still does not operate, you must program your garage door. See **Programming the Garage Door Opener to Your Garage Door Opener Motor** (page 161).

4. To program additional buttons, repeat Steps 1 – 4.

CLEARING THE GARAGE DOOR OPENER

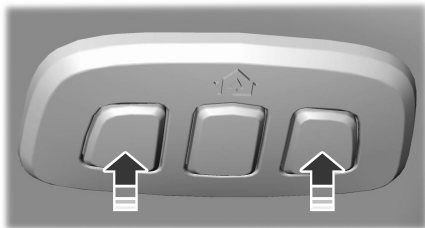

1. Press and hold the outer two function buttons simultaneously for approximately 10 seconds until the indicator light above the buttons flashes rapidly.

Garage Door Opener (If Equipped)

2. When the indicator light flashes, release the buttons.

Note: *You cannot erase individual buttons.*

REPROGRAMMING THE GARAGE DOOR OPENER

To program a device to a previously trained button, follow these steps:

1. Press and hold the desired button. Do NOT release the button.
2. The indicator light begins to flash after 20 seconds. Without releasing the button, follow programming steps.

GARAGE DOOR OPENER RADIO FREQUENCIES

FCC and RSS-210 Industry Canada Compliance



WARNING: Changes or modifications not expressly approved by the party responsible for compliance could void the user's authority to operate the equipment. The term "IC:" before the radio certification number only signifies that Industry Canada technical specifications were met.

This device complies with Part 15 of the FCC Rules and with RSS-210 of Industry Canada. Operation is subject to the following two conditions: (1) this device may not cause harmful interference, and (2) this device must accept any interference received, including interference that could cause undesired operation.

This equipment complies with FCC radiation exposure limits set forth for an uncontrolled environment. End Users must follow the specific operating instructions for satisfying RF exposure compliance. This transmitter must be at least 8 in (20 cm) from the user and must not be co-located or operating in conjunction with any other antenna or transmitter.

Auxiliary Power Points

12 Volt DC Power Point



WARNING: Do not plug optional electrical accessories into the cigar lighter socket. Incorrect use of the cigar lighter can cause damage not covered by the vehicle warranty, and can result in fire or serious injury.

Note: When you switch the ignition on, you can use the socket to power 12 volt appliances with a maximum current rating of 15 amps.

Note: If the power supply does not work after you switch the ignition off, switch the ignition on.

Note: Do not hang any accessory from the accessory plug.

Note: Do not use the power point over the vehicle capacity of 12 volt DC 180 watts or a fuse may blow.

Note: Always keep the power point caps closed when not in use.

Do not insert objects other than an accessory plug into the power point. This damages the power point and may blow the fuse.

Run the vehicle for full capacity use of the power point.

To prevent the battery from running out of charge:

- Do not use the power point longer than necessary when the vehicle is not running.
- Do not leave devices plugged in overnight or when you park your vehicle for extended periods.

USB Port and Power Point Locations

USB Ports and Power Points may be in the following locations:

- On the lower instrument panel.
- Inside the center console.
- On the front of the center console.
- On the rear of the center console.
- In the cargo area.
- On the passenger side floor panel.
- 3rd row on the quarter trim panels.

Note: Some of the USB ports may not have data transfer capabilities.

Note: Incorrect use of the USB ports can cause damage not covered by the vehicle warranty.

110 Volt AC Power Point



WARNING: Do not keep electrical devices plugged into the power outlet whenever the device is not in use. The outlet provides power when the vehicle is on. Failure to follow this instruction could result in personal injury.



WARNING: Do not use an extension cord or connect multiple devices to the power outlet. Doing so could result in overloading the power outlet. Failure to follow this instruction could result in fire, personal injury or property damage.

Note: The power point turns off when you switch off the ignition, when the vehicle is not in accessory mode or when the battery voltage drops below 11 volts.

You can use the power point for electric devices that require up to 150 watts. It is on the rear of the center console.

Auxiliary Power Points

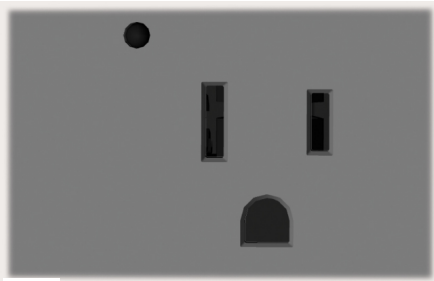

E247586

When the indicator light on the power point is:

- On: The power point is working, the ignition is ON or the vehicle is in accessory mode.
- Off: The power point is OFF, the ignition is OFF or the vehicle is not in accessory mode.
- Flashing: The power point is in fault mode.

Due to the different technologies used on its construction, some devices may exceed the capacity shown on its label when they are initially plugged-in.

The power outlet temporarily turns off power when in fault mode if the device exceeds the 150 watt limit. Unplug your device and switch the ignition off. Switch the ignition back on, but do not plug your device back in. Let the system cool off and switch the ignition off to reset the fault mode. Switch the ignition back on and make sure the indicator light remains on.

Do not use the power point for certain electric devices, including:

- Cathode-ray, tube-type televisions.
- Motor loads, such as vacuum cleaners, electric saws and other electric power tools or compressor-driven refrigerators.

- Measuring devices, which process precise data, such as medical equipment or measuring equipment.
- Other appliances requiring an extremely stable power supply such as microcomputer-controlled electric blankets or touch-sensor lamps.

Wireless Accessory Charger (If Equipped)

WHAT IS THE WIRELESS ACCESSORY CHARGER

The wireless accessory charger allows you to charge one compatible Qi wireless charging device on the charging area.

WIRELESS ACCESSORY CHARGER PRECAUTIONS



WARNING: Wireless charging devices can affect the operation of implanted medical devices, including cardiac pacemakers. If you have any implanted medical devices, we recommend that you consult with your physician.

Keep the charging area clean and remove foreign objects prior to charging a device.

Do not place items with a magnetic strip or radio-frequency identification chip, for example passports, parking tickets, transportation passes or credit cards, near the charging area when charging a device. Damage could occur to the magnetic strip or radio-frequency identification chip.

Do not place metal objects, for example remote controls, coins and candy wrappers, on or near the charging area when charging a device. Metal objects may heat up and degrade the charging performance, in addition to causing interruptions in charging.

Charging could be interrupted, degraded, or could stop if any of the following occur:

- The system detects a foreign object.
- The device is misaligned on the charging area.
- The device moves on the active charging area when the vehicle is in motion.

- The vehicle ambient temperature is too high.
- You attempt to charge a non-Qi compatible device on the wireless charger.

Note: *During charging, the device and the charger could heat up, this is normal. If the battery gets hotter than usual, the device may stop charging.*

LOCATING THE WIRELESS ACCESSORY CHARGER



The charging area is on the center console or in the media bin below the instrument panel.

CHARGING A WIRELESS DEVICE

Place the device on the center of the charging surface with the charging side down. The charging stops after your device reaches a full charge.

You can use the charger when the vehicle is in accessory mode, when the vehicle is running, or when SYNC is on.



Displays on the status bar when wireless charging is in progress.

Note: *The charging performance may be affected if your device is in a case. It may be necessary to remove the case to wirelessly charge your device.*

Note: *Software and firmware updates may affect device compatibility, including the use of unofficial software or firmware. You should verify charging functionality with your specific devices in-vehicle.*

Storage Compartments

CUP HOLDERS

Note: *Stow items in the cupholders carefully as items may become loose during hard braking, acceleration or crashes, including hot drinks which may spill.*

OVERHEAD CONSOLE

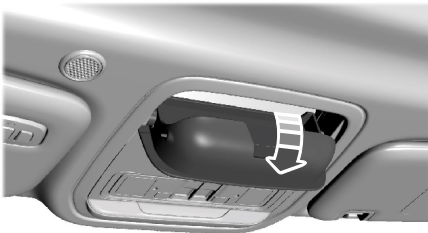

Press the rear edge of the overhead console door to open the glasses holder.

Starting and Stopping the Engine

GENERAL INFORMATION

WARNING: Extended idling at high engine speeds can produce very high temperatures in the engine and exhaust system, creating the risk of fire or other damage.

WARNING: Do not park, idle or drive your vehicle on dry grass or other dry ground cover. The emission system heats up the engine compartment and exhaust system, creating the risk of fire.

WARNING: Do not start the engine in a closed garage or in other enclosed areas. Exhaust fumes are toxic. Always open the garage door before you start the engine. Failure to follow this instruction could result in personal injury or death.

WARNING: Exhaust leaks may result in entry of harmful and potentially lethal fumes into the passenger compartment. If you smell exhaust fumes inside your vehicle, have your vehicle inspected immediately. Do not drive if you smell exhaust fumes.

The powertrain control system meets all Canadian interference-causing equipment standard requirements regulating the impulse electrical field or radio noise.

Note: If you use your vehicle regularly above the altitude of 7,500 ft (2,286 m) and under the temperature of -4.0°F (-20°C), it is recommended to use the alternative engine oil. See **Capacities and Specifications** (page 378).

If you disconnect the battery, your vehicle may exhibit some unusual driving characteristics for approximately 6 mi (10 km) after you reconnect it. This is because the engine management system must realign itself with the engine. You can disregard any unusual driving characteristics during this period.

When you start the engine, avoid pressing the accelerator pedal before and during operation. Only use the accelerator pedal when you have difficulty starting the engine.

IGNITION SWITCH

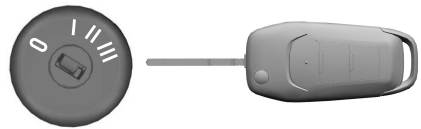

0 (off) - The ignition is off.

Note: When you switch the ignition off and leave your vehicle, do not leave your key in the ignition. This could cause your vehicle battery to lose charge.

I (accessory) - Allows the electrical accessories, such as the radio, to operate while the engine is not running.

Note: Do not leave the ignition key in this position for too long. This could cause your vehicle battery to lose charge.

II (on) - All electrical circuits are operational and the warning lamps and indicators illuminate.

III (start) - Cranks the engine.

Starting and Stopping the Engine

KEYLESS STARTING (IF EQUIPPED)

Note: The system may not function if the remote control is close to metal objects or electronic devices, for example keys or a cell phone.

Note: A valid remote control must be located inside your vehicle to switch the ignition on and start your vehicle.

Ignition Modes



The keyless starting system has three modes:

Off: Turns the ignition off.

- Without applying the brake pedal, press and release the button once when the ignition is in the on mode, or when your vehicle is running but is not moving.

On: All electrical circuits are operational and the warning lamps and indicators illuminate.

- Without applying the brake pedal, press and release the button once.

Start: Starts your vehicle. The engine may not start when your vehicle starts.

- Press the brake pedal, and then press the button for any length of time.

STARTING A GASOLINE ENGINE

When you start the engine, the idle speed increases. This helps to warm up the engine. If the engine idle speed does not slow down, have your vehicle checked as soon as possible.

Note: You can crank the engine for a total of 60 seconds without the engine starting before the starting system temporarily disables. The 60 seconds does not have to be all at once. For example, if you crank the engine three times for 20 seconds each time, without the engine starting, you reached the 60-second time limit. A message appears in the information display alerting you that you exceeded the cranking time. You cannot attempt to start the engine for at least 15 minutes. After 15 minutes, you are limited to a 15-second engine cranking time. You need to wait 60 minutes before you can crank the engine for 60 seconds again.

Before starting your vehicle, check the following:

- Make sure all occupants fasten their seatbelt.
- Make sure the headlamps and electrical accessories are off.
- Make sure the parking brake is on.
- Make sure the transmission is in park (P).
- Switch the ignition on. For vehicles with a keyless ignition, see the following instructions.

Vehicles with an Ignition Key

Note: Do not touch the accelerator pedal.

- Fully press the brake pedal.
- Turn the key to the start position to start your vehicle.

Starting and Stopping the Engine

Note: The engine may continue cranking for up to 15 seconds or until it starts.

Note: If you cannot start the engine on the first try, wait for a short period and try again.

Vehicles with Keyless Start

Note: Do not touch the accelerator pedal.

Note: You must have your intelligent access key in your vehicle in order to shift the transmission out of park (P).

1. Fully press the brake pedal.
2. Press the push button ignition switch.

The system does not function if:

- The passive key frequencies are jammed.
- The key battery has no charge.

If you are unable to start your vehicle, do the following:

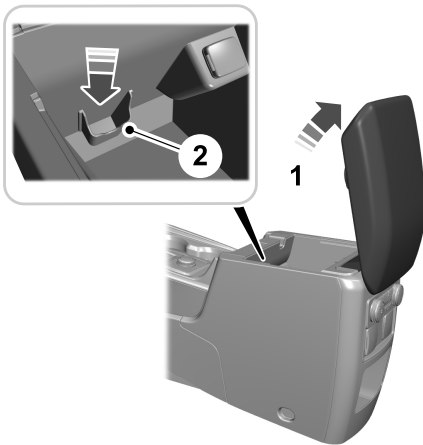

1. Open the floor console storage compartment lid.
2. Insert the passive key into the backup slot.

3. With the key in this position, press the brake pedal then press the push button ignition switch to switch the ignition on and start your vehicle.

Fast Restart

The fast restart feature allows you to restart your vehicle within 20 seconds of switching it off, even if it does not detect a valid passive key.

After 20 seconds, you can no longer start your vehicle if it does not detect a valid passive key. Within 20 seconds of switching the engine off, press the brake pedal and press the push button ignition switch.

Once your vehicle starts, it remains running until you press the push button ignition switch, even if your vehicle does not detect a valid passive key. If you open and close a door while your vehicle is running, the system searches for a valid passive key. You cannot start your vehicle if the system does not detect a valid passive key within 20 seconds.

Failure to Start

If you cannot start the engine after three attempts, wait 10 seconds and follow this procedure:

1. Fully press the brake pedal.
2. Shift into park (P).
3. Fully press the accelerator pedal and hold it there.
4. Attempt to start your vehicle and wait until the engine stops cranking.
5. Release the accelerator pedal.
6. Start the engine.

Starting and Stopping the Engine

Automatic Engine Shutdown

For vehicles with a keyless ignition, this feature shuts down the engine if it has been idling for an extended period. The ignition also turns off in order to save battery power. Before your vehicle shuts down, a message appears in the information display showing a timer counting down from 30 seconds. If you do not intervene within 30 seconds, your vehicle shuts down. Another message appears in the information display to inform you that your vehicle has shut down to save fuel. Start your vehicle as you normally do.

Automatic Engine Shutdown Override

You can stop the shutdown, or reset the timer, at any point before the 30-second countdown has expired by doing any of the following:

- You can reset the timer by interacting with your vehicle, for example pressing the brake or accelerator pedal.
- You can temporarily switch off the shutdown feature any time the ignition is on. Use the vehicle settings on your touchscreen to switch the **30min Max Idle** on or off. The feature only remains off for the current ignition cycle.
- During the 30-second countdown, the system prompts you to press OK or RESET to temporarily switch the feature off for the current ignition cycle only.

Note: *You cannot permanently switch off the automatic shutdown feature. When you temporarily switch it off, it turns on at the next ignition cycle.*

Stopping the Engine When Your Vehicle is Stationary

Vehicles with an Ignition Key

1. Shift into park (P).

2. Switch the ignition off.
3. Apply the parking brake.

Vehicles with Keyless Start

1. Shift into park (P).
2. Press the push button ignition switch.
3. Apply the parking brake.

Note: *The ignition, all electrical circuits and all warning lamps and indicators will be turned off.*

Note: *If the engine is idling for 30 minutes, the ignition and engine automatically shut down.*

Stopping the Engine When Your Vehicle is Moving



WARNING: Switching off the engine when your vehicle is still moving results in a significant decrease in braking assistance. Higher effort is required to apply the brakes and to stop your vehicle. A significant decrease in steering assistance could also occur. The steering does not lock, but higher effort could be required to steer your vehicle. When you switch the ignition off, some electrical circuits, for example airbags, also turn off. If you unintentionally switch the ignition off, shift into neutral (N) and restart the engine.

Vehicles with an Ignition Key

1. Switch the ignition off.
2. Shift into neutral and use the brakes to bring your vehicle to a safe stop.
3. Apply the parking brake.

Vehicles with Keyless Start

1. Press and hold the push button ignition switch, or press it three times within two seconds.

Starting and Stopping the Engine

2. Shift into neutral and use the brakes to bring your vehicle to a safe stop.
3. Shift into park (P).
4. Apply the parking brake.

Guarding Against Exhaust Fumes



WARNING: Exhaust leaks may result in entry of harmful and potentially lethal fumes into the passenger compartment. If you smell exhaust fumes inside your vehicle, have your vehicle inspected immediately. Do not drive if you smell exhaust fumes.

Important Ventilating Information

If you stop your vehicle and then leave the engine idling for long periods, we recommend that you do one of the following:

- Open the windows at least 1 in (3 cm).
- Set your climate control to outside air.

STARTING A HYBRID ELECTRIC VEHICLE SYSTEM

Before starting your vehicle, check the following:

- Make sure all occupants fasten their seatbelt.
- Make sure the headlamps and electrical accessories are off.
- Make sure the parking brake is on.
- Make sure the transmission is in park (P).

Note: Do not touch the accelerator pedal.

1. Fully press the brake pedal.
2. Press the push button ignition switch.

Note: The green ready indicator illuminates letting you know that your vehicle is ready for driving. Since your vehicle comes with a silent key start, the engine may not start when your vehicle starts. See **Hybrid Vehicle Operation** (page 178).

When the engine starts for the first time on your drive, the idle speed increases, this helps to warm up the engine. If the engine idle speed does not slow down, have your vehicle checked by an authorized dealer.

The system does not function if:

- The passive key frequencies are jammed.
- The key battery has no charge.

If you are unable to start your vehicle, do the following:

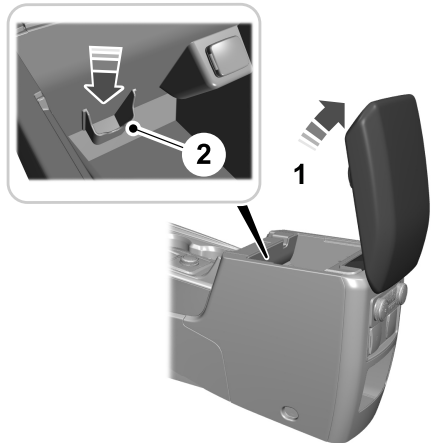

1. Open the floor console storage compartment lid.
2. Insert the passive key into the backup slot.
3. With the key in this position, press the brake pedal then press the push button ignition switch to switch the ignition on and start your vehicle.

Starting and Stopping the Engine

Fast Restart

The fast restart feature allows you to restart your vehicle within 20 seconds of switching it off, even if it does not detect a valid passive key.

Within 20 seconds of switching your vehicle off, press the brake pedal and press the push button ignition switch. After 20 seconds, you can no longer start your vehicle if it does not detect a valid passive key.

Once your vehicle starts, it remains running until you press the push button ignition switch, even if your vehicle does not detect a valid passive key. You cannot start your vehicle if the system does not detect a valid passive key within 20 seconds.

Automatic Engine Shutdown

For vehicles with a keyless ignition, this feature shuts down the engine if it has been idling for an extended period. The ignition also turns off in order to save battery power. Before your vehicle shuts down, a message appears in the information display showing a timer counting down from 30 seconds. If you do not intervene within 30 seconds, your vehicle shuts down. Another message appears in the information display to inform you that your vehicle has shut down to save fuel. Start your vehicle as you normally do.

Note: *Automatic Engine Shutdown may be more frequent for hybrid vehicles.*

Automatic Engine Shutdown Override

Note: *You cannot permanently switch off the automatic shutdown feature. When you switch it off temporarily, it turns on at the next ignition cycle.*

You can stop the shutdown, or reset the timer, at any point before the 30-second countdown expires by doing any of the following:

- You can reset the timer by interacting with your vehicle, for example pressing the brake or accelerator pedal.
- You can temporarily switch off the shutdown feature any time the ignition is on using the information display. See **Information Displays** (page 110). The feature only remains off for the current ignition cycle.
- During the 30-second countdown, the system prompts you to press OK or RESET to temporarily switch the feature off for the current ignition cycle only.

Switching Off Your Vehicle When It Is Stationary

1. Put the transmission in park (P).
2. Press the push button ignition switch once.
3. Apply the parking brake.

Note: *This switches off the ignition, warning lamps and indicators.*

Switching Off Your Vehicle When It Is Moving



WARNING: Switching off the engine when your vehicle is still moving results in a significant decrease in braking assistance. Higher effort is required to apply the brakes and to stop your vehicle. A significant decrease in steering assistance could also occur. The steering does not lock, but higher effort

Starting and Stopping the Engine

could be required to steer your vehicle. When you switch the ignition off, some electrical circuits, for example airbags, also turn off. If you unintentionally switch the ignition off, shift into neutral (N) and restart the engine.

1. Put the transmission into neutral (N) and use the brakes to bring your vehicle to a safe stop.
2. When your vehicle has stopped, put the transmission in park (P).
3. Press and hold the push button ignition switch for one second, or press it three times within two seconds.
4. Apply the parking brake.

Guarding Against Exhaust Fumes



WARNING: Exhaust leaks may result in entry of harmful and potentially lethal fumes into the passenger compartment. If you smell exhaust fumes inside your vehicle, have your vehicle inspected immediately. Do not drive if you smell exhaust fumes.

Important Ventilating Information

If you stop your vehicle and then leave the engine idling for long periods of time, we recommend that you do one of the following:

- Open the windows at least 1 in (3 cm).
- Set your climate control to outside air.

ENGINE BLOCK HEATER (IF EQUIPPED)



WARNING: Failure to follow engine block heater instructions could result in property damage or serious personal injury.



WARNING: Do not use your heater with ungrounded electrical systems or two-pronged adapters. There is a risk of electrical shock.



WARNING: Do not fully close the hood, or allow it to drop under its own weight when using the engine block heater. This could damage the power cable and may cause an electrical short resulting in fire, injury and property damage.

Note: *The heater is most effective when outdoor temperatures are below 0°F (-18°C).*

The heater acts as a starting aid by warming the engine coolant. This allows the climate control system to respond quickly. The equipment includes a heater element, installed in the engine block and a wire harness. You can connect the system to a grounded 120-volt AC electrical source.

We recommend that you do the following for a safe and correct operation:

- Use a 16-gauge outdoor extension cord that is product certified by Underwriter's Laboratory (UL) or Canadian Standards Association (CSA). This extension cord must be suitable for use outdoors, in cold

Starting and Stopping the Engine

temperatures, and be clearly marked Suitable for Use with Outdoor Appliances. Do not use an indoor extension cord outdoors. This could result in an electric shock or become a fire hazard.

- Use as short an extension cord as possible.
- Do not use multiple extension cords.
- Make sure that when in operation, the extension cord plug and heater cord plug connections are free and clear of water. This could cause an electric shock or fire.
- If the block heater cord is under the hood, Do Not remove the wiring from its original location. Do Not close the hood on the extension wiring.
- Make sure your vehicle is parked in a clean area, clear of combustibles.
- Make sure the heater, heater cord and extension cord are firmly connected.
- Check for heat anywhere in the electrical hookup once the system has been operating for approximately 30 minutes.
- Make sure the system is unplugged and properly stowed before starting and driving your vehicle. Make sure the protective cover seals the prongs of the block heater cord plug when not in use.
- Make sure the heater system is checked for proper operation before winter.

The heater uses 0.4 to 1.0 kilowatt-hours of energy per hour of use. The system does not have a thermostat. It achieves maximum temperature after approximately three hours of operation. Using the heater longer than three hours does not improve system performance and unnecessarily uses electricity.

Using the Engine Block Heater

Make sure the receptacle terminals are clean and dry prior to use. Clean them with a dry cloth if necessary.

Unique Driving Characteristics

AUTO-START-STOP (IF EQUIPPED)

The system helps reduce fuel consumption by automatically stopping and restarting the engine when your vehicle has stopped. The engine restarts automatically when you release the brake pedal.

In some situations, your vehicle may restart automatically, for example:

- To maintain interior comfort.
- To recharge the battery.

Note: Power assist steering turns off when the engine is off.

Note: If your vehicle is flex fuel capable, Auto-Start-Stop will be inhibited for a short time after a refuel event while the system is verifying the fuel type being used.



WARNING: Apply the parking brake, shift into park (P), switch the ignition off and remove the key before you leave your vehicle. Failure to follow this instruction could result in personal injury or death.



WARNING: Apply the parking brake, shift into park (P), switch the ignition off and remove the key before you open the hood or have any service or repair work completed. If you do not switch the ignition off, the engine could restart at any time. Failure to follow this instruction could result in personal injury or death.



WARNING: The system may require the engine to automatically restart when the auto-start-stop indicator illuminates green or flashes amber. Failure to follow this instruction could result in personal injury.

The Auto-Start-Stop system status is available at a glance within the information display. See **Information Displays** (page 110).

Enabling Auto-Start-Stop

The system automatically enables every time you start your vehicle if:

- You do not press the Auto-Start-Stop button (not illuminated).
- Your vehicle exceeds an initial speed of 3 mph (5 km/h) after you have initially started your vehicle.
- You have stopped your vehicle.
- Your foot is on the brake pedal.
- The driver door is closed.
- The interior compartment has cooled or warmed to an acceptable level.
- The front windshield defroster is off.
- You have not turned the steering wheel rapidly or you do not have it at a sharp angle.
- The vehicle is not on a steep road grade.
- The battery is within optimal operating conditions (battery state of charge and temperature in range).
- The engine coolant is near operating temperature.
- Elevation is below about 12,000 ft (3,650 m).
- Ambient temperature is moderate.
- The trailer is not connected.
- If you select Normal, Eco, Snow/Wet or Grass/Gravel/Snow modes.
- You are not in 4H or 4L.
- You have not selected Manual shift mode.
- Hill descent control is not active.
- You have not selected Tow haul, Sport, Sand or Mud/Rut modes.

Unique Driving Characteristics

Note: Note when in Sport mode it can be enabled by pressing the Auto-Start-Stop button.



The green Auto-Start-Stop indicator light on the instrument cluster will illuminate to indicate when the automatic engine stop occurs.



If the instrument cluster is equipped with a grey Auto-Start-Stop indicator light, it illuminates when automatic engine stop is not available due to one of the above noted conditions not being met.

Automatic Engine Restart

Any of the following conditions will result in an automatic restart of the engine:

- You have removed your foot from the brake pedal.
- You press the accelerator pedal.
- You press the accelerator and the brake pedal at the same time.
- The driver safety belt becomes unfastened or the driver door is ajar.
- Your vehicle is moving.
- The interior compartment does not meet customer comfort when air conditioning or heat is on.
- Fogging of the windows could occur and the air conditioning is on.
- The battery is not within optimal operating conditions.
- You have exceeded the maximum engine off time.
- When you press the Auto-Start-Stop button with the engine automatically stopped.
- The front defroster is turned to the Max setting.
- When you shift into park (P), the engine will restart.

Any of the following conditions may result in an automatic restart of the engine:

- You have increased the blower fan speed or changed the climate control temperature.
- You have an electrical accessory turned on or plugged in.

Note: You may notice that the climate seat fan fluctuates during an automatic restart.

Disabling Auto-Start-Stop



E255783

Press the Auto-Start-Stop button on the center console to switch the system off. The button will illuminate. Deactivating using the button lasts only 1 key cycle. Press the button again to restore Auto-Start-Stop function.

Note: If the Shift to park (P), Restart Engine message appears and the amber Auto-Start-Stop indicator light flashes, this indicates automatic restart is unavailable. You must restart the vehicle manually. See **Information Displays** (page 110).

If your vehicle is in engine off Auto-Start-Stop, shifting from drive (D) to reverse (R) will not cause a restart if you do not press the brake pedal. The message Auto-Start-Stop Press Brake to Start Engine appears. You must press the brake pedal within 60 seconds or the system requires you to shift into park (P) and manually restart your vehicle.

Unique Driving Characteristics

HYBRID VEHICLE OPERATION - HYBRID ELECTRIC VEHICLE (HEV)

This hybrid vehicle combines electric and gasoline propulsion to provide breakthrough performance and improved efficiency. Familiarizing yourself with these unique characteristics provides an optimal driving experience from your vehicle.

Starting

READY When you start your vehicle, a green READY indicator light appears in the instrument cluster letting you know that your vehicle is ready for driving.

The engine may not start because your vehicle has a silent key start feature. This fuel saving feature allows your vehicle to be ready to drive without requiring the gas engine to be running. The indicator remains on when your vehicle is on, whether the engine is running or not, to indicate your vehicle is capable of movement using the electric motor, gas engine or both. Typically, the engine does not start unless the vehicle is cold, a climate control change is requested or you press the accelerator pedal.

Driving

The gas engine automatically starts and stops to provide power when needed and to save fuel when not needed. When coasting at low speeds, coming to a stop, or standing, the gas engine normally shuts down and your vehicle operates in electric-only mode.

Conditions that may cause the engine to start up or remain running include:

- Considerable vehicle acceleration.
- Climbing a hill.

- Charge level of high voltage battery is low.
- High or low outside temperatures in order to provide system heating or cooling.
- Engine not warm enough to provide passenger requested cabin temperature.
- Towing a trailer.
- Selectable drive modes: Certain selectable drive modes may cause the engine to run. See **What Is Drive Mode Control** (page 273).
- Live in Drive: Use of the paddle shifters while in drive (D) may cause the engine to run. See **Automatic Transmission** (page 197).

Stopping

The gas engine may shut off to conserve fuel as you come to a stop. Restarting your vehicle is not required. Simply step on the accelerator when you are ready to drive.

Transmission Operation

The engine and electric motor together propel the vehicle through the automatic transmission. This is normal hybrid operating and helps deliver fuel efficiency and performance.

Battery

Your hybrid is equipped with a high voltage battery. A cool battery maintains battery life and provides the best possible performance. The high voltage battery is cooled by the vehicle's air conditioning system. When the air conditioning system is on, you may notice a slight increase in air temperature coming from the climate control vents while the battery is cooling. You may also notice cool air flowing from the vents when the air conditioning or blower is off.

Unique Driving Characteristics

Braking

Your hybrid is equipped with standard hydraulic braking and regenerative braking. Regenerative braking is performed by your transmission and it captures brake energy and stores it in the high voltage battery.

You may also notice during extending downhill driving that your engine continues to run instead of shutting off. During this engine braking, the engine stays on, but it is not using any fuel. You may also hear a slight whine or whistle when operating your vehicle. This is the normal operation of the electric motor in the hybrid system.

Driving to Optimize Fuel Economy

Note: *Having your engine running is not always an indication of inefficiency. In some cases, it is actually more efficient than driving in electric mode.*

Your fuel economy should improve throughout your hybrid's break-in period. As with any vehicle, your driving habits and accessory usage can significantly impact your fuel economy. For best results, keep these tips in mind:

- Keep the tires properly inflated and only use the recommended size.
- Aggressive driving increases the amount of energy required to move your vehicle. In general, you can achieve better fuel economy with mild to moderate acceleration and deceleration. Moderate braking is particularly important since it allows you to maximize the energy captured by the regenerative braking system.

Additional Tips:

- Do not carry extra loads.
- Be mindful of adding external accessories that may increase aerodynamic drag.
- Observe posted speed limits.
- Perform all scheduled maintenance.
- There is no need to wait for your engine to warm up. The vehicle is ready to drive immediately after starting.

Unique Driving Characteristics

HYBRID VEHICLE FREQUENTLY ASKED QUESTIONS - HYBRID ELECTRIC VEHICLE (HEV)

Question	Answer
What are the series of clicks from the cargo area when I switch the ignition on?	The high voltage battery is electrically isolated from the rest of the vehicle when the ignition is off. When you switch the ignition on, the high voltage contacts inside the battery are closed. This makes the electricity available to the motor and generator and allows your vehicle to proceed. The clicks are the sound of these contacts as they close and open during start up and shut down.
Why does the engine sometimes start at key-on?	The vehicle's computer determines if an engine start is required at key-on. Silent key starts the engine if it is necessary for cabin heating, windshield defrost, or if the outside temperature is low.
Why does it take a long time before the engine shuts down?	There are several reasons the engine stays on for an extended amount of time when you first start it. One common reason is to make sure that the emission's components are warm enough to minimize tailpipe emissions. As the climate gets cooler, this engine-on time is extended.
Why does my engine stay on when it is extremely cold outside?	In order to make sure that the climate control system can begin heating the cabin or defrosting the windshield as soon as you request it, the engine coolant temperature has to be kept sufficiently hot. Keeping the engine on is required to maintain the correct coolant temperature.
Can I put E15 or E85 in my vehicle, and how will it affect my fuel economy?	Your hybrid vehicle can use E15 fuel (15% ethanol, 85% gasoline), but you could notice slightly reduced fuel economy because ethanol contains less energy per gallon than gasoline. Your hybrid vehicle is not designed to use E85 (85% ethanol).
How long will my high voltage battery last? Does it need maintenance?	The high voltage battery system is designed to last the life of the vehicle and requires no maintenance.

Fuel and Refueling

SAFETY PRECAUTIONS



WARNING: Do not overfill the fuel tank. The pressure in an overfilled tank may cause leakage and lead to fuel spray and fire.



WARNING: The fuel system may be under pressure. If you hear a hissing sound near the fuel filler inlet, do not refuel until the sound stops. Otherwise, fuel may spray out, which could cause serious personal injury.



WARNING: Fuels can cause serious injury or death if misused or mishandled.



WARNING: Fuel may contain benzene, which is a cancer-causing agent.



WARNING: When refueling always shut the engine off and never allow sparks or open flames near the fuel tank filler valve. Never smoke or use a cell phone while refueling. Fuel vapor is extremely hazardous under certain conditions. Avoid inhaling excess fumes.

Follow these guidelines when refueling:

- Extinguish all smoking materials and any open flames before refueling your vehicle.
- Always switch the engine off before refueling.
- Automotive fuels can be harmful or fatal if swallowed. Fuel is highly toxic and if swallowed can cause death or permanent injury. If fuel is swallowed immediately call a physician, even if no symptoms are immediately apparent. The toxic effects of fuel may not be apparent for hours.

- Avoid inhaling fuel vapors. Inhaling fuel vapor can lead to eye and respiratory tract irritation. In severe cases, excessive or prolonged breathing of fuel vapor can cause serious illness and permanent injury.
- Avoid getting fuel in your eyes. If you splash fuel in your eyes, immediately remove contact lenses (if worn), flush with water for 15 minutes and seek medical attention. Failure to seek proper medical attention could lead to permanent injury.
- Fuels can be harmful if absorbed through the skin. If you splash fuel on your skin, clothing or both, promptly remove contaminated clothing and thoroughly wash your skin with soap and water. Repeated or prolonged skin contact causes skin irritation.
- Be particularly careful if you are taking Antabuse or other forms of Disulfiram for the treatment of alcoholism. Breathing fuel vapors could cause an adverse reaction, serious personal injury or sickness. Immediately call a physician if you experience any adverse reactions.

FUEL QUALITY - E85

Choosing the Right Fuel - Flex Fuel Vehicles

Flex fuel vehicles have one of the following identifiers:

- Yellow fuel filler cap.
- Yellow bezel around the fuel filler inlet.
- Yellow fuel filler housing.
- Yellow E85 label on the fuel tank filler door.

Fuel and Refueling



Your vehicle is designed to operate on regular unleaded gasoline with a minimum pump (R+M)/2 octane rating of 87 or regular unleaded gasoline blended with a maximum of 85% ethanol (E85).

Some fuel stations, particularly those in high altitude areas, offer fuels posted as regular unleaded gasoline with an octane rating below 87. The use of these fuels could result in engine damage that will not be covered by the vehicle warranty.

For best overall vehicle and engine performance, premium fuel with an octane rating of 91 or higher is recommended. The performance gained by using premium fuel is most noticeable in hot weather as well as other conditions, for example when towing a trailer. See **Towing** (page 283).

Do not be concerned if the engine sometimes knocks lightly. However, if the engine knocks heavily while using fuel with the recommended octane rating, contact an authorized dealer to prevent any engine damage.

We recommend Top Tier detergent gasolines, where available to help minimize engine deposits and maintain optimal vehicle and engine performance. For additional information, refer to www.toptiergas.com.

Note: *Use of any fuel for which the vehicle was not designed can impair the emission control system, cause loss of vehicle performance, and cause damage to the engine which may not be covered by the vehicle Warranty.*

Do not use:

- Diesel fuel.
- Fuels containing kerosene or paraffin.
- Fuels containing more than 85% ethanol or E100 fuel.
- Fuels containing methanol.
- Fuels containing metallic-based additives, including manganese-based compounds.
- Fuels containing the octane booster additive, methylcyclopentadienyl manganese tricarbonyl (MMT).
- Leaded fuel, using leaded fuel is prohibited by law.

The use of fuels with metallic compounds such as methylcyclopentadienyl manganese tricarbonyl (commonly known as MMT), which is a manganese-based fuel additive, will impair engine performance and affect the emission control system.

Switching Between E85 and Gasoline

We do not recommend repeatedly alternating between E85 and gasoline. If you switch from using E85 to gasoline, or from gasoline to E85, add as much fuel as possible, at least half a tank. Drive your vehicle immediately for a minimum of 5 mi (8 km) to allow it to adapt to the change in ethanol concentration. If you use E85 exclusively, we recommend that you fill the fuel tank with regular unleaded gasoline at each scheduled oil change.

Fuel and Refueling

FUEL QUALITY - GASOLINE

Choosing the Right Fuel

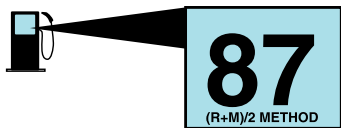

Your vehicle is designed to operate on regular unleaded gasoline with a minimum pump (R+M)/2 octane rating of 87.

Some fuel stations, particularly those in high altitude areas, offer fuels posted as regular unleaded gasoline with an octane rating below 87. The use of these fuels could result in engine damage that will not be covered by the vehicle warranty.

For best overall vehicle and engine performance, premium fuel with an octane rating of 91 or higher is recommended. The performance gained by using premium fuel is most noticeable in hot weather as well as other conditions, for example when towing a trailer. See **Towing** (page 283).

Do not be concerned if the engine sometimes knocks lightly. However, if the engine knocks heavily while using fuel with the recommended octane rating, contact an authorized dealer to prevent any engine damage.

We recommend Top Tier detergent gasolines, where available to help minimize engine deposits and maintain optimal vehicle and engine performance. For additional information, refer to www.toptiergas.com.

Note: Use of any fuel for which the vehicle was not designed can impair the emission control system, cause loss of vehicle performance, and cause damage to the engine which may not be covered by the vehicle Warranty.

Do not use:

- Diesel fuel.
- Fuels containing kerosene or paraffin.
- Fuel containing more than 15% ethanol or E85 fuel.
- Fuels containing methanol.
- Fuels containing metallic-based additives, including manganese-based compounds.
- Fuels containing the octane booster additive, methylcyclopentadienyl manganese tricarbonyl (MMT).
- Leaded fuel, using leaded fuel is prohibited by law.

The use of fuels with metallic compounds such as methylcyclopentadienyl manganese tricarbonyl (commonly known as MMT), which is a manganese-based fuel additive, will impair engine performance and affect the emission control system.

FUEL FILLER FUNNEL LOCATION

The fuel filler funnel is in the spare wheel storage tray.

RUNNING OUT OF FUEL

Running out of fuel can cause damage not covered by the vehicle Warranty.

Fuel and Refueling

If your vehicle runs out of fuel:

- Add a minimum of 1.3 gal (5 L) of fuel to restart the engine.
- You may need to switch the ignition from off to on several times after refueling to allow the fuel system to pump the fuel from the tank to the engine. When restarting, cranking time takes a few seconds longer than normal.

Note: *If your vehicle is on a steep slope, more fuel may be required.*

Filling a Portable Fuel Container

 **WARNING:** Flow of fuel through a fuel pump nozzle can produce static electricity. This can cause a fire if you are filling an ungrounded fuel container.

Use the following guidelines to avoid electrostatic charge build-up, which can produce a spark, when filling an ungrounded fuel container:

- Only use an approved fuel container to transfer fuel to your vehicle. Place the container on the ground when filling it.
- Do not fill a fuel container when it is inside your vehicle (including the cargo area).
- Keep the fuel pump nozzle in contact with the fuel container when filling it.
- Do not use a device that holds the fuel pump nozzle lever in the fill position.

Adding Fuel From a Portable Fuel Container

 **WARNING:** Do not insert the nozzle of a fuel container or an aftermarket funnel into the fuel filler neck. This may damage the fuel system filler neck or its seal and cause fuel to run onto the ground.

 **WARNING:** Do not try to pry open or push open the capless fuel system with foreign objects. This could damage the fuel system and its seal and cause injury to you or others.

 **WARNING:** Do not dispose of fuel in the household refuse or the public sewage system. Use an authorized waste disposal facility.

When refueling the vehicle fuel tank from a fuel container, use the fuel filler funnel included with your vehicle. See **Fuel Filler Funnel Location** (page 183).

Note: *Do not use aftermarket funnels as they may not work with the capless fuel system and can damage it.*

When refueling the vehicle fuel tank from a fuel container, do the following:

1. Fully open the fuel filler door.
2. Fully insert the fuel filler funnel into the fuel filler inlet.

Fuel and Refueling

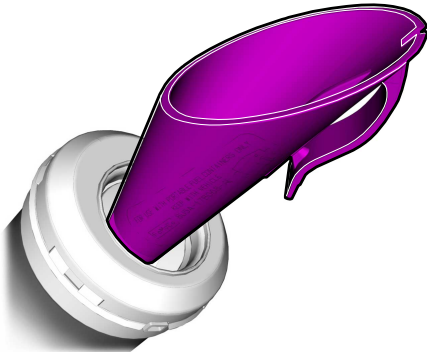

3. Add fuel to your vehicle from the fuel container.
4. Remove the fuel filler funnel.
5. Fully close the fuel filler door.
6. Clean the fuel filler funnel and place it back in your vehicle or correctly dispose of it.

Note: *Extra funnels can be purchased from an authorized dealer if you choose to dispose of the funnel.*

REFUELING - EXCLUDING: HYBRID ELECTRIC VEHICLE (HEV)

Refueling System Overview

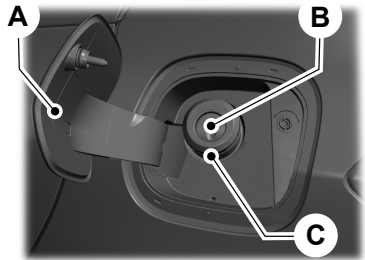

- A Fuel filler door.
- B Fuel tank filler valve.
- C Fuel tank filler pipe.

Your vehicle does not have a fuel tank filler cap.

Fuel and Refueling

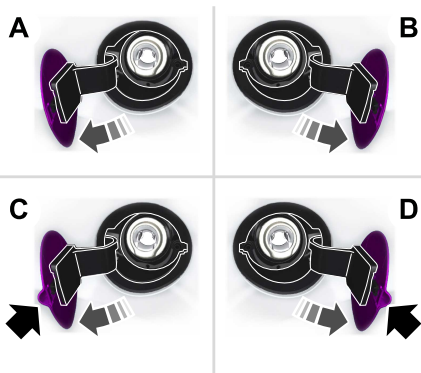

- A Left-hand side. To open the fuel filler door, press the center rear edge of the fuel filler door and then release.
- B Right-hand side. To open the fuel filler door, press the center rear edge of the fuel filler door and then release.
- C Left-hand side. Pull the rear of the fuel filler door to open it.
- D Right-hand side. Pull the rear of the fuel filler door to open it.

Refueling Your Vehicle

WARNING: When refueling always shut the engine off and never allow sparks or open flames near the fuel tank filler valve. Never smoke or use a cell phone while refueling. Fuel vapor is extremely hazardous under certain conditions. Avoid inhaling excess fumes.

WARNING: The fuel system may be under pressure. If you hear a hissing sound near the fuel filler inlet, do not refuel until the sound stops. Otherwise, fuel may spray out, which could cause serious personal injury.

WARNING: Do not pry open the fuel tank filler valve. This could damage the fuel system. Failure to follow this instruction could result in fire, personal injury or death.

WARNING: Do not remove the fuel pump nozzle from its fully inserted position when refueling.

WARNING: Stop refueling when the fuel pump nozzle automatically shuts off for the first time. Failure to follow this will fill the expansion space in the fuel tank and could lead to fuel overflowing.

WARNING: Do not overfill the fuel tank. The pressure in an overfilled tank may cause leakage and lead to fuel spray and fire.

WARNING: Wait at least five seconds before removing the fuel pump nozzle to allow any residual fuel to drain into the fuel tank.

WARNING: Read and follow all the instructions on the pump island.

1. Fully open the fuel filler door.
2. Select the correct fuel pump nozzle for your vehicle.

Fuel and Refueling

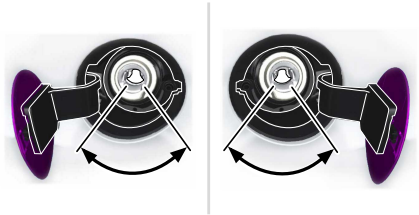
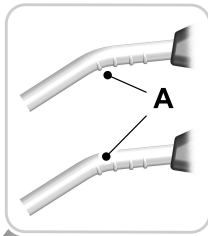

3. Insert the fuel pump nozzle up to the first notch on the nozzle A. Keep the fuel pump nozzle resting on the fuel tank filler pipe.

5. Operate the fuel pump nozzle within the area shown.

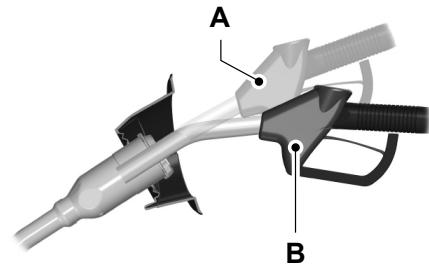
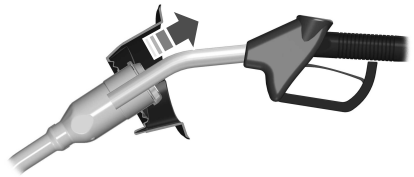

E139203

4. Hold the fuel pump nozzle in position B when refueling. Holding the fuel pump nozzle in position A can affect the flow of fuel and shut off the fuel pump nozzle before the fuel tank is full.

6. When the nozzle shuts off, wait at least 5 seconds, then slightly raise the fuel pump nozzle and slowly remove it.
7. Fully close the fuel filler door.

Do not attempt to start the engine if you have filled the fuel tank with incorrect fuel. Incorrect fuel use could cause damage that the vehicle Warranty may not cover. See your authorized dealer immediately.

Refueling System Warning (If Equipped)

If the fuel tank filler valve does not fully close, a message could appear in the information display.

Message
Check Fuel Fill Inlet

If the message appears, do the following:

1. Stop your vehicle as soon as it is safe to do so and switch the engine off.
2. Shift into park (P) or neutral (N).

Fuel and Refueling

3. Apply the parking brake.
4. Fully open the fuel filler door.
5. Check the fuel tank filler valve for any debris that may be restricting its movement.
6. Remove any debris from the fuel tank filler valve.
7. Fully insert a fuel pump nozzle or the fuel filler funnel provided with your vehicle into the fuel filler pipe. See **Fuel Filler Funnel Location** (page 183). This action should dislodge any debris that may be preventing the fuel tank filler valve from fully closing.
8. Remove the fuel pump nozzle or fuel filler funnel from the fuel filler pipe.
9. Fully close the fuel filler door.

Note: *The message may not immediately reset. If the message continues to appear and a warning lamp illuminates, see your authorized dealer as soon as possible.*

REFUELING - HYBRID ELECTRIC VEHICLE (HEV)

WARNING: When refueling always shut the engine off and never allow sparks or open flames near the fuel tank filler valve. Never smoke or use a cell phone while refueling. Fuel vapor is extremely hazardous under certain conditions. Avoid inhaling excess fumes.

WARNING: The fuel system may be under pressure. If you hear a hissing sound near the fuel filler inlet, do not refuel until the sound stops. Otherwise, fuel may spray out, which could cause serious personal injury.

WARNING: Do not pry open the fuel tank filler valve. This could damage the fuel system. Failure to follow this instruction could result in fire, personal injury or death.

WARNING: Do not remove the fuel pump nozzle from its fully inserted position when refueling.

WARNING: Stop refueling when the fuel pump nozzle automatically shuts off for the first time. Failure to follow this will fill the expansion space in the fuel tank and could lead to fuel overflowing.

WARNING: Do not overfill the fuel tank. The pressure in an overfilled tank may cause leakage and lead to fuel spray and fire.

WARNING: Wait at least five seconds before removing the fuel pump nozzle to allow any residual fuel to drain into the fuel tank.

WARNING: Read and follow all the instructions on the pump island.

1. When you stop your vehicle, shift into park (P) and switch the ignition off.



Fuel and Refueling

- Press the button on the left side of the instrument panel next to the headlamp switch to open the fuel filler door. The fuel filler door can take up to 15 seconds to open before you can insert a fuel filler nozzle.

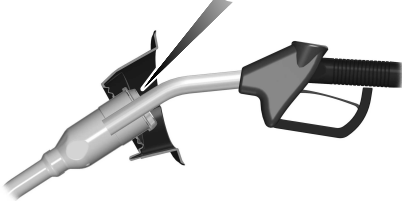
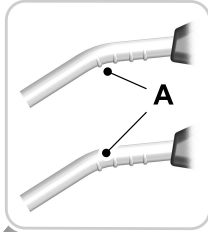

- Insert the fuel pump nozzle up to the first notch on the nozzle A. Keep it resting on the cover of the fuel tank filler pipe opening.

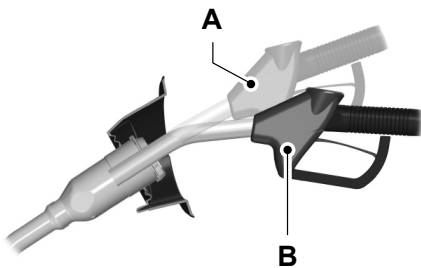

E139203

- Hold the fuel pump nozzle in position B when refueling. Holding the fuel pump nozzle in position A can affect the flow of fuel and shut off the fuel pump nozzle before the fuel tank is full.

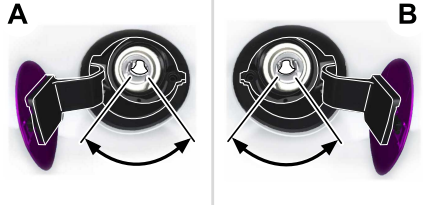

- Operate the fuel pump nozzle within the area shown.

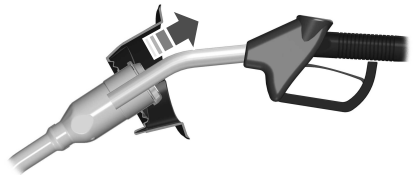

- When the pump shuts off, wait 5 seconds, then slowly lift and remove the nozzle.
- Fully close the fuel filler door.

Note: To close the fuel filler door, press the center rear edge of the fuel filler door and then release.

Complete the refueling process within 20 minutes. If 20 minutes elapses, press the button on the left side of the instrument panel again. Fuel pump nozzle automatic shut off could occur if you do not press the button on the left side instrument panel.

System Warnings

If the fuel filler door fails to open, an information message appears in the information display.

Fuel and Refueling

Message	Action
Please wait for fuel door to open	Your vehicle has a sealed fuel system that may be under pressure. This information message appears while the fuel system is depressurizing with the fuel filler door closed. Wait for the fuel system to depressurize and for the fuel filler door to unlatch.
Fuel Door Open	This information message appears when the fuel system depressurizes and the fuel filler door opens. Fully open the fuel filler door to refuel and fully close the fuel filler door when refueling is complete.
Fuel door ajar Close fully to avoid ""Check Engine"" light	Your vehicle has a sealed fuel system that requires the fuel filler door to be fully closed after refueling. This warning message appears when the fuel filler door is ajar. Please fully close the fuel filler door to avoid a "Check Engine" Light.

Message	Action
	If you see this message and a "Check Engine" lamp illuminates, please fully close the fuel filler door. The "Check Engine" Light should clear within five seconds. If the "Check Engine" light persists, please see your dealer.
Refuel Error See Manual	A warning message appears in the information display when the fuel system fails to depressurize or the fuel filler door fails to open. You may have to use the fuel filler door manual override lever.

If the Refuel Error information message appears, do the following:

1. Check the fuel filler door for anything that may be obstructing its movement, for example ice or snow.
2. Remove any obstruction from the fuel filler door.
3. Press the button on the left side of the instrument panel to open the fuel filler door.
4. If the fuel filler door fails to open and the Refuel Error message remains in the information display, use the fuel filler door manual override lever.

Fuel Filler Door Manual Override Lever



WARNING: The fuel system may be under pressure. If you hear a hissing sound near the fuel filler inlet, do not refuel until the sound stops. Otherwise, fuel may spray out, which could cause serious personal injury.

Fuel and Refueling

Note: The transmission must be in park (P) or neutral (N).

When using the manual override lever do the following:

1. Switch the ignition on.

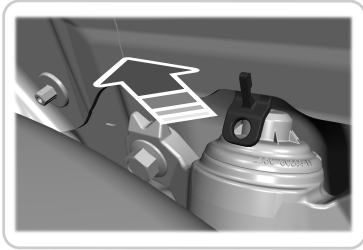

Note: The manual override lever is in the driver side rear wheel well area.

2. Pull the manual override lever.
3. Switch the ignition off.
4. Complete the refueling process within 20 minutes.

FUEL CONSUMPTION

Advertised Capacity

The advertised capacity is the maximum amount of fuel that you can add to the fuel tank when the fuel gauge indicates empty. See **Capacities and Specifications** (page 384).

In addition, the fuel tank contains an empty reserve. The empty reserve is an unspecified amount of fuel that remains in the fuel tank when the fuel gauge indicates empty.

Note: The amount of fuel in the empty reserve varies and should not be relied upon to increase driving range.

Calculating Fuel Economy

Your vehicle calculates fuel economy figures through the trip computer average fuel function. See **Information Displays** (page 110).

The first 1,000 mi (1,600 km) of driving is the break-in period of the vehicle. Resetting average fuel in your trip computer after 2,000–3,000 mi (3,200–4,800 km) provides a more accurate measurement.

Conditions Influencing Fuel Efficiency

See **Driving Economically** (page 288).

Engine Emission Control

EMISSION LAW



WARNING: Do not remove or alter the original equipment floor covering or insulation between it and the metal floor of the vehicle. The floor covering and insulation protect occupants of the vehicle from the engine and exhaust system heat and noise. On vehicles with no original equipment floor covering insulation, do not carry passengers in a manner that permits prolonged skin contact with the metal floor. Failure to follow these instructions may result in fire or personal injury.

U.S. federal laws and certain state laws prohibit removing or rendering inoperative emission control system components. Similar federal or provincial laws may apply in Canada. We do not approve of any vehicle modification without first determining applicable laws.



Tampering with emissions control systems including related sensors or the Diesel Exhaust Fluid system can result in reduced engine power and the illumination of the service engine soon light.

Tampering With a Noise Control System

Federal laws prohibit the following acts:

- Removal or rendering inoperative by any person other than for purposes of maintenance.
- Repair or replacement of any device or element of the design incorporated into a new vehicle for the purpose of noise control prior to its sale or delivery to the ultimate purchaser or while it is in use.
- The use of the vehicle after any person removes or renders inoperative any device or element of the design.

The U.S. Environmental Protection Agency may presume to constitute tampering as follows:

- Removal of hood blanket, fender apron absorbers, fender apron barriers, underbody noise shields or acoustically absorptive material.
- Tampering or rendering inoperative the engine speed governor, to allow engine speed to exceed manufacturer specifications.

If the engine does not start, runs rough, experiences a decrease in engine performance, experiences excess fuel consumption or produces excessive exhaust smoke, check for the following:

- A plugged or disconnected air inlet system hose.
- A plugged engine air filter element.
- Water in the fuel filter and water separator.
- A clogged fuel filter.
- Contaminated fuel.
- Air in the fuel system, due to loose connections.
- An open or pinched sensor hose.
- Incorrect engine oil level.

Engine Emission Control

- Incorrect fuel for climatic conditions.
- Incorrect engine oil viscosity for climactic conditions.

Note: *Some vehicles have a lifetime fuel filter that is integrated with the fuel tank. Regular maintenance or replacement is not needed.*

Note: *If these checks do not help you correct the concern, have your vehicle checked as soon as possible.*

Noise Emissions Warranty, Prohibited Tampering Acts and Maintenance

On January 1, 1978, Federal regulation became effective governing the noise emission on trucks over 10,000 lb (4,536 kg) Gross Vehicle Weight Rating (GVWR). The preceding statements concerning prohibited tampering acts and maintenance, and the noise warranty found in the Warranty Guide, are applicable to complete chassis cabs over 10,000 lb (4,536 kg) GVWR.

CATALYTIC CONVERTER



WARNING: Do not park, idle or drive your vehicle on dry grass or other dry ground cover. The emission system heats up the engine compartment and exhaust system, creating the risk of fire.



WARNING: The normal operating temperature of the exhaust system is very high. Never work around or attempt to repair any part of the exhaust system until it has cooled. Use special care when working around the catalytic converter. The catalytic converter heats up to a very high temperature after only a short period of engine operation and stays hot after the engine is switched off.



WARNING: Exhaust leaks may result in entry of harmful and potentially lethal fumes into the passenger compartment. If you smell exhaust fumes inside your vehicle, have your vehicle inspected immediately. Do not drive if you smell exhaust fumes.

Your vehicle has various emission control components and a catalytic converter that enables it to comply with applicable exhaust emission standards.

To make sure that the catalytic converter and other emission control components continue to work properly:

- Do not crank the engine for more than 10 seconds at a time.
- Do not run the engine with a spark plug lead disconnected.
- Do not push-start or tow-start your vehicle. Use booster cables. See **Jump Starting the Vehicle** (page 293).
- Use only the specified fuel listed.
- Do not switch the ignition off when your vehicle is moving.
- Avoid running out of fuel.
- Have the items listed in scheduled maintenance information performed according to the specified schedule.

Note: *Resulting component damage may not be covered by the vehicle Warranty.*

The scheduled maintenance items listed in scheduled maintenance information are essential to the life and performance of your vehicle and to its emissions system.

If you use anything other than Ford, Motorcraft or Ford-authorized parts for maintenance replacements or for service of components affecting emission control, such non-Ford parts should be equivalent to genuine Ford Motor Company parts in performance and durability.

Engine Emission Control

Illumination of the service engine soon indicator, charging system warning light or the temperature warning light, fluid leaks, strange odors, smoke or loss of engine power could indicate that the emission control system is not working properly.

An improperly operating or damaged exhaust system may allow exhaust to enter the vehicle. Have a damaged or improperly operating exhaust system inspected and repaired immediately.

Do not make any unauthorized changes to your vehicle or engine. By law, vehicle owners and anyone who manufactures, repairs, services, sells, leases, trades vehicles, or supervises a fleet of vehicles are not permitted to intentionally remove an emission control device or prevent it from working. Information about your vehicle's emission system is on the Vehicle Emission Control Information Decal located on or near the engine. This decal also lists engine displacement.

Please consult your warranty information for complete details.

On-Board Diagnostics (OBD-II)

Your vehicle has a computer known as the on-board diagnostics system (OBD-II) that monitors the engine's emission control system. The system protects the environment by making sure that your vehicle continues to meet government emission standards. The OBD-II system also assists a service technician in properly servicing your vehicle.



When the service engine soon indicator illuminates, the OBD-II system has detected a malfunction. Temporary malfunctions may cause the service engine soon indicator to illuminate. Examples are:

1. Your vehicle has run out of fuel—the engine may misfire or run poorly.
2. Poor fuel quality or water in the fuel—the engine may misfire or run poorly.
3. The fuel fill inlet may not have closed properly. See **Refueling** (page 185).
4. Driving through deep water—the electrical system may be wet.

You can correct these temporary malfunctions by filling the fuel tank with good quality fuel, properly closing the fuel fill inlet or letting the electrical system dry out. After three driving cycles without these or any other temporary malfunctions present, the service engine soon indicator should stay off the next time you start the engine. A driving cycle consists of a cold engine startup followed by mixed city and highway driving. No additional vehicle service is required.

If the service engine soon indicator remains on, have your vehicle serviced at the first available opportunity. Although some malfunctions detected by the OBD-II may not have symptoms that are apparent, continued driving with the service engine soon indicator on can result in increased emissions, lower fuel economy, reduced engine and transmission smoothness and lead to more costly repairs.

Readiness for Inspection and Maintenance (I/M) Testing

Some state and provincial and local governments may have Inspection/Maintenance (I/M) programs to inspect the emission control equipment on your vehicle. Failure to pass this inspection could prevent you from getting a vehicle registration.



If the service engine soon indicator is on or the bulb does not work, your vehicle may need service. See On-Board Diagnostics.

Engine Emission Control

Your vehicle may not pass the I/M test if the service engine soon indicator is on or not working properly (bulb is burned out), or if the OBD-II system has determined that some of the emission control systems have not been properly checked. In this case, the vehicle is not ready for I/M testing.

If the vehicle's engine or transmission has just been serviced, or the battery has recently run down or been replaced, the OBD-II system may indicate that the vehicle is not ready for I/M testing. To determine if the vehicle is ready for I/M testing, turn the ignition key to the on position for 15 seconds without cranking the engine. If the service engine soon indicator blinks eight times, it means that the vehicle is not ready for I/M testing; if the service engine soon indicator stays on solid, it means that your vehicle is ready for I/M testing.

The OBD-II system checks the emission control system during normal driving. A complete check may take several days.

If the vehicle is not ready for I/M testing, you can perform the following driving cycle consisting of mixed city and highway driving:

1. 15 minutes of steady driving on an expressway or highway followed by 20 minutes of stop-and-go driving with at least four 30-second idle periods.
2. Allow your vehicle to sit for at least eight hours with the ignition off. Then, start the vehicle and complete the above driving cycle. The vehicle must warm up to its normal operating temperature. Once started, do not turn off the vehicle until the above driving cycle is complete.

If the vehicle is still not ready for I/M testing, you need to repeat the above driving cycle.

High Voltage Battery (If Equipped)

GENERAL INFORMATION - HYBRID ELECTRIC VEHICLE (HEV)



WARNING: This battery pack should only be serviced by an authorized electric vehicle technician. Improper handling can result in personal injury or death.



WARNING: Apply the parking brake, shift into park (P), switch the ignition off and remove the key before you open the hood or have any service or repair work completed. If you do not switch the ignition off, the engine could restart at any time. Failure to follow this instruction could result in personal injury or death.



WARNING: Do not touch the electronic ignition system parts after you have switched the ignition on or when the engine is running. The system operates at high voltage. Failure to follow this instruction could result in serious personal injury or death.



WARNING: Keep your hands and clothing clear of the engine cooling fan.

The high-voltage battery system is a high-voltage, lithium-ion battery system. The pack is located underneath the vehicle. The high voltage battery system uses an advanced active liquid heating and cooling system to regulate high voltage battery temperature and help maximize the life of the high voltage battery.

Note: *The high-voltage battery does not require regular service maintenance.*

Your vehicle consists of various high-voltage components and wiring. All of the high-voltage power flows through specific wiring assemblies labeled as such or covered with a solid orange convolute, or orange striped tape, or both. Do not come in contact with these components.

Transmission

AUTOMATIC TRANSMISSION



WARNING: Apply the parking brake and make sure your vehicle is in park (P). Power the vehicle off and remove the keys or remote control whenever you leave your vehicle. Failure to follow this instruction could result in personal injury or death.



WARNING: Do not apply the brake pedal and accelerator pedal simultaneously. Applying both pedals simultaneously for more than a few seconds limits vehicle performance, which may result in difficulty maintaining speed in traffic and could lead to serious injury.

Note: You may not be able to shift out of park (P) unless the intelligent access key is inside your vehicle.

Automatic Transmission Position Indicators

The instrument cluster displays the current position.

P R N D M

P R N D L

Note: The position may illuminate on the transmission selector.

Understanding Your Transmission Selector Positions

Your vehicle has an electronic transmission shifter. The transmission selector is on the center console.



E227917

- P Park.
- R Reverse.
- N Neutral.
- D Drive.
- M Manual.
- L Low.

The instrument cluster displays the current gear.

Note: Your vehicle may come with low (L) or manual (M) in the center of the selector depending on trim level.

Park (P)

With the transmission in park (P), your vehicle locks the transmission and prevents the wheels from turning. Always come to a complete stop before putting your vehicle into and out of park (P).

When you switch the ignition off, your vehicle shifts into park (P). If you switch the ignition off while your vehicle is moving, the transmission first shifts into neutral (N) until it reaches a speed less than 3 mph (5 km/h) and then shifts into park (P).

Transmission

The electric parking brake could apply when you shift to park (P) without the brake pedal fully pressed. The electric parking brake applies when you shift to park (P) on large slopes. The electric parking brake releases with the drive away release function or manually. See **Electric Parking Brake** (page 211).

Note: *A warning tone sounds if you open the driver door and you have not shifted the transmission selector to park (P).*

Automatic Return to Park

What is Automatic Return to Park (P)

Your vehicle shifts in park (P) if you attempt to exit your vehicle without the transmission in park (P).

How Does Automatic Return to Park (P) Work

Your vehicle shifts into park (P) when your vehicle is stationary and any of the following occur:

- You switch the vehicle off.
- You open the driver door with your seatbelt unlatched.
- You unlatch the driver seatbelt when the driver door is open.

Note: *Do not use automatic return to park (P) when your vehicle is moving, except in an emergency. See **Starting and Stopping the Engine** (page 168).*

Automatic Return to Park (P) Limitations

Automatic return to park (P) may not work if the door ajar switch is malfunctioning.

Have the system checked immediately if any of the following occur:

- Door ajar indicator does not illuminate with the driver door open.
- Door ajar indicator illuminates with the driver door closed.
- Transmission not in park message appears with the driver door closed, after you shift out of park (P).

Reverse (R)

With the transmission selector in reverse (R), your vehicle moves backward. Always come to a complete stop before shifting into and out of reverse (R).

Neutral (N)

With the transmission selector in neutral (N), you can start your vehicle and it is free to roll. Hold the brake pedal down when in this position.

Temporary Neutral Mode

What is Temporary Neutral Mode

This mode keeps your vehicle in neutral (N) when you switch your vehicle off. Use this mode at an automatic car wash if you exit your vehicle or switch your vehicle off.

Note: *Do not tow your vehicle in this mode.*

Note: *Automatic return to park (P) delays when your vehicle is in this mode.*

Temporary Neutral Mode Limitations

Your vehicle may shift to park (P) after 30 minutes, or when the vehicle battery charge level is low. Prolonged use of this mode can cause the vehicle battery to run out of charge.

Do not tow your vehicle in this mode. Failure to follow these instructions could result in vehicle damage not covered by the vehicle warranty.

Entering Temporary Neutral Mode

1. Switch your vehicle on.

Transmission

2. Bring your vehicle to a complete stop.
3. Press and hold the brake pedal.
4. Shift into neutral (N).

Note: *A instructional message appears.*

5. Press the manual (M), or low (L) button.

Note: *A confirmation message appears when your vehicle enters the mode.*

6. Release the brake pedal.

Note: *Your vehicle is free to roll.*

7. Switch your vehicle off.

Note: *Do not tow your vehicle in this mode.*

Note: *The neutral (N) indicator on the transmission selector may flash in this mode.*

Exiting Temporary Neutral Mode

1. Press the brake pedal.
2. Shift into park (P), or switch your vehicle on and shift into drive (D), or reverse (R).

Drive (D)

Drive (D) is the normal driving position for the best fuel economy and smoothness. Shift the transmission selector to drive (D) to allow your vehicle to move forward and shift automatically through the forward gears.

The transmission shifts to the appropriate gear for optimum performance based on ambient temperature, road slope, vehicle load and your input.

Manual Mode (M) - Vehicles with Paddle Shifters

With the transmission selector in manual (M), the driver can change gears up or down. After selecting the Manual (M) button while the transmission range selector is in the Drive (D) position, you now have control of selecting the gear you desire using shift buttons on the steering wheel.

To exit manual mode, push the manual (M) button on your transmission selector.

Low (L) - Vehicles without Paddle Shifters

With the transmission selector in low (L), your vehicle provides maximum engine braking. You can shift the transmission into low (L) at any vehicle speed. Do not use under extended or normal driving conditions as it results in lower fuel economy.

Manually Shifting Gears

Shifting Using Paddle Shifters

The instrument cluster displays the current gear. The current gear flashes when your vehicle cannot shift into the requested gear. Your vehicle will not shift if the requested gear raises or lowers the engine speed beyond the limit.

Your vehicle may shift when you fully press the accelerator or brake pedal.

Note: *Prolonged driving with high engine speed could cause vehicle damage not covered by vehicle warranty.*

Note: *When the vehicle shifts into the requested gear, it could affect drive modes.*

Transmission



Manually Shifting Gears in Drive (D)

Use this feature when overtaking another vehicle, or to temporarily change gear.

- Pull any paddle to switch the feature on.
- Pull the right (+) paddle to upshift.
- Pull the left (-) paddle to downshift.
- Hold the (+) paddle for a few seconds to switch the feature off.

Note: If you do not pull either paddle, the feature switches off after a short period of time.

Manually Shifting Gears in Manual (M)

Use this feature for engine braking on hilly or mountainous roads, or to select a specific gear.

- Shift to manual (M) to switch the feature on.
- Pull the right (+) paddle to upshift.
- Pull the left (-) paddle to downshift.
- Shift to drive (D) to switch the feature off.

Tow Mode (If Equipped)

TOW HAUL To activate tow mode, use the drive mode switch on the center console. See **Selecting a Drive Mode** (page 273).

The indicator light illuminates and a message displays in the instrument cluster when the system becomes active. Select a different mode to switch the system off.

The Tow Mode Feature:

- Moves upshifts to higher engine speeds to reduce the frequency of transmission shifting.
- Provides engine braking in all forward gears, which slows your vehicle and assists you in controlling your vehicle when descending a slope.
- Depending on driving conditions and load conditions, it may downshift the transmission, slow your vehicle and control your vehicle speed when descending a hill, without pressing the accelerator pedal. The amount of downshift braking provided varies based upon the amount you press the brake pedal.

The tow mode feature improves transmission operation when towing a trailer or a heavy load. All transmission gear ranges are available when using tow mode.

Transmission Not in Park (P) Audible Warning

Sounds if you open the driver door before shifting into park (P).

Manual Park Release (MPR)



WARNING: When doing this procedure, you need to take the transmission out of park (P) which means your vehicle can roll freely. To avoid unwanted vehicle movement, apply the parking brake prior to doing this procedure. Use wheel chocks if appropriate.

Transmission



WARNING: If the parking brake is fully released, but the brake warning lamp remains illuminated, the brakes may not be working properly. Have your vehicle checked as soon as possible.



WARNING: Do not drive your vehicle until you verify that the stoplamps are working.

Use the manual park release to move your transmission from the park (P) position in the event of an electrical malfunction or emergency.

Activating the Manual Park Release Cable

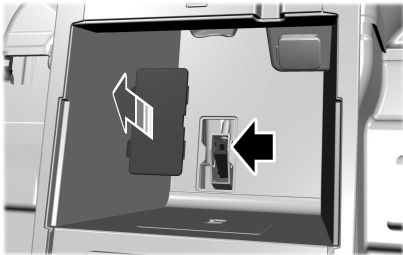

1. Apply the parking brake. See **Electric Parking Brake** (page 211).

Note: If the vehicle battery is dead, for example, no electrical power is available, you require an external power to apply the parking brake.

2. Using a flat head screwdriver, maximum length 5 in (120 mm), as shown in the picture, carefully open the access cover under the arm rest console.

3. Switch the vehicle ignition on without starting the vehicle by pressing the ignition push to start without pressing the brake.
4. Once in the driver seat, fully apply the brake pedal and hold. Do not release.

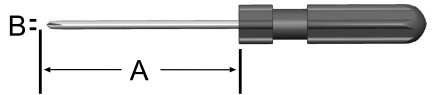

Note: A: 2.0 in (50 mm) B: 0.1 in (3.3 mm)

5. Insert a screwdriver type tool into the Manual Park Release (MPR) lever slot. Pull the manual park release lever toward the rear until the detent in the slot pops up, against the tool. Allow full upward travel of detent, approximately 0.28 in (7 mm) in the park override mode (Click). You can remove the tool. If done correctly, a message on the instrument cluster displays Park Not Available, Transmission Not in Park, or Shift System Fault.
6. With your foot still fully applied on the brake pedal, disengage the parking brake. See **Electric Parking Brake** (page 211).
7. Your vehicle remains in neutral (N) for emergency towing purposes.
8. Switch off the ignition.
9. Once safe, and there is no risk of your vehicle rolling, disconnect the negative (black) battery cable from the battery.

Transmission

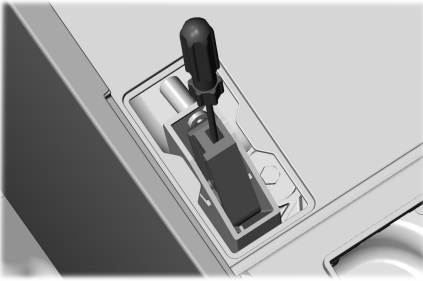

Returning Your Vehicle to Normal Mode

1. Reconnect the negative (black) battery cable to the battery.
2. Apply the parking brake. See **Electric Parking Brake** (page 211).

Note: *If the vehicle battery is dead, for example, no electrical power is available, you require an external power to apply the parking brake.*

3. Fully apply the brake pedal and hold, do not release.
4. Insert the screwdriver tool fully into the manual park release lever slot. Push the tool downwards. The system detent releases and the manual park release lever moves forward, allowing the vehicle to go back into park (P). Remove the tool.
5. Install the access cover.
6. With your foot fully applied on the brake pedal, start your vehicle. Confirm that your vehicle is in the park (P) position and that the instrument cluster indicates park (P).

7. If the instrument cluster does not display the park (P) position or there is a message stating park (P) is not available, transmission not in park (P) or a shift system fault, apply the parking brake before exiting your vehicle and have your vehicle checked immediately.

If Your Vehicle Gets Stuck in Mud or Snow

If your vehicle gets stuck in mud or snow, rock it out by shifting between forward and reverse gears, stopping between shifts in a steady pattern. Press lightly on the accelerator in each gear.

Note: *Do not rock the vehicle if the engine is not at normal operating temperature or damage to the transmission could occur.*

Note: *Do not rock the vehicle for more than a minute or damage to the transmission and tires may occur, or the engine could overheat.*

Four-Wheel Drive (If Equipped)

PRINCIPLE OF OPERATION

This system is a proactive system. It has the ability to anticipate wheel slip and transfer torque to the front wheels before slip occurs. Even when wheel slip is not present, the system is continuously adjusting to the torque distribution, in an attempt to improve straight line and cornering behavior, both on and off road.

The system automatically turns on every time you switch the ignition on.

If any component requires maintenance, a message appears in the information display.

USING FOUR-WHEEL DRIVE



WARNING: Vehicles with a higher center of gravity (utility and four-wheel drive vehicles) handle differently than vehicles with a lower center of gravity (passenger cars). Avoid sharp turns, excessive speed and abrupt steering in these vehicles. Failure to drive cautiously increases the risk of losing control of your vehicle, vehicle rollover, personal injury and death.

The intelligent 4WD system continuously monitors vehicle conditions and adjusts the power distribution between the front and rear wheels. It combines transparent all-surface operation with highly capable four-wheel drive.

The 4WD system is always active and requires no driver input. It is capable of handling all road conditions including street and highway driving as well as off-road and winter driving. You can optimize more 4WD control by selecting different drive modes. See **Selecting a Drive Mode** (page 273).

Note: A warning message displays in the information display when a 4WD system fault is present. See **Information Messages** (page 119). A 4WD system fault causes the 4WD system to default to rear-wheel drive only mode. When this warning message is displayed, have your vehicle serviced at an authorized dealer.

Note: A warning message displays in the information display if the 4WD system overheats. See **Information Messages** (page 119). This condition could occur if the vehicle is operated in extreme conditions with excessive wheel slip, such as deep sand. To resume normal 4WD function as soon as possible, stop the vehicle in a safe location and stop the engine for at least 10 minutes. After the engine is restarted and the 4WD system is adequately cooled, the warning message turns off and normal 4WD function returns.

Operating Four-Wheel Drive (4WD) Vehicles With Spare Tires

Do not use a different size spare tire other than the tire provided. If the mini-spare tire is installed, the 4WD system will disable and enter rear-wheel drive only mode to protect driveline components. Some limited 4WD traction could be provided if the mini-spare is installed on one of the front wheels. If you are in driving conditions where limited 4WD traction is needed while the mini-spare is installed, it is recommended the mini-spare be installed on the front axle. See **Information Messages** (page 119).

If the mini-spare is installed, this condition is indicated by a warning in the information display. If there is a warning message in the information display from using the spare tire, this indicator should turn off after reinstalling or replacing the normal road tire and cycling the ignition off and on. We recommended reinstalling or

Four-Wheel Drive (If Equipped)

replacing the normal road tire as soon as possible. Major dissimilar tire sizes between the front and rear axles could cause the 4WD system to stop functioning and default to rear-wheel drive or damage the 4WD system.

The slip response system could activate if the mini spare is installed on the front wheels. If the mini spare was installed on the rear wheels the slip response system will fully disable. In situations where there is a wintery mix or an off road situation, and you need to use a mini spare, you must install the mini spare in the front tire position and move a full size tire to the rear tire position for the slip response system to function.

Operating Four-Wheel drive (4WD) Vehicles with Mismatched Tires



WARNING: Only use replacement tires and wheels that are the same size, load index, speed rating and type (such as P-metric versus LT-metric or all-season versus all-terrain) as those originally provided by Ford. The recommended tire and wheel size may be found on either the Safety Compliance Certification Label (affixed to either the door hinge pillar, door-latch post, or the door edge that meets the door-latch post, next to the driver's seating position), or the Tire Label which is located on the B-Pillar or edge of the driver's door. If this information is not found on these labels, then you should contact your authorized dealer as soon as possible. Use of any tire or wheel not recommended by Ford can affect the safety and performance of your vehicle, which could result in an increased risk of loss of vehicle control, vehicle rollover, personal injury and death.

Major dissimilar tire sizes between the front and rear axles (for example, 17 inch low profile tires on the front axle and 22 inch high profile tires on the rear axle) could cause the 4WD system to stop functioning and default to rear-wheel drive or damage the 4WD system.

For optimum 4WD Performance, it is recommended to follow the tire rotation maintenance schedule. To avoid potential 4WD malfunction or 4WD system damage, it is recommended to replace all four tires rather than mixing significantly worn tires with new tires. For example, using 3 worn tread tires and 1 new tread tire all of the same original tire size/brand, can be tolerated by the 4WD system as long as the worn tires still have usable tread depth.

How Your Vehicle Differs from Other Vehicles

Truck and utility vehicles can differ from some other vehicles. Your vehicle could be higher to allow it to travel over rough terrain without getting hung up or damaging underbody components.

The differences that make your vehicle so versatile also make it handle differently than an ordinary passenger car.

Maintain steering wheel control at all times, especially in rough terrain. Since sudden changes in terrain can result in abrupt steering wheel motion, make sure you grip the steering wheel from the outside. Do not grip the spokes.

Drive cautiously to avoid vehicle damage from concealed objects such as rocks and stumps.

You should either know the terrain or examine maps of the area before driving. Map out your route before driving in the area. To maintain steering and braking control of your vehicle, you must have all four wheels on the ground and they must be rolling, not sliding or spinning.

Four-Wheel Drive (If Equipped)

Driving in Special Conditions With Four-Wheel drive (4WD)

Note: Use of the 4WD system in slippery, deep snow, and sand drive modes on dry surfaces could produce some vibration, driveline bind up, or excessive tire wear as these drive modes are intended for slippery and loose surfaces.

Note: The design of 4WD vehicles are for driving on sand, snow, mud and rough roads and have operating characteristics that are somewhat different from conventional vehicles, both on and off the highway.

Basic Operating Principles in Special Conditions

- Drive slower in strong crosswinds which can affect the normal steering characteristics of your vehicle.
- Be extremely careful when driving on pavement made slippery by loose sand, water, gravel, snow or ice.

If Your Vehicle Goes Off the Edge of the Pavement

- If your vehicle goes off the edge of the pavement, slow down, but avoid severe brake application, ease the vehicle back onto the pavement only after reducing your speed. Do not turn the steering wheel too sharply while returning to the road surface.
- It could be safer to stay on the apron or shoulder of the road and slow down gradually before returning to the pavement. You could lose control if you do not slow down or if you turn the steering wheel too sharply or abruptly.
- It often could be less risky to strike small objects, such as highway reflectors, with minor damage to your vehicle rather than attempt a sudden return to the pavement which could cause the vehicle to slide sideways out of control or rollover. Remember, your safety and the safety of others should be your primary concern.

If Your Vehicle Gets Stuck



WARNING: Apply the parking brake, shift into park (P), switch the ignition off and remove the key before you leave your vehicle. Failure to follow this instruction could result in personal injury or death.



WARNING: If the parking brake is fully released, but the brake warning lamp remains illuminated, the brakes may not be working properly. Have your vehicle checked as soon as possible.



WARNING: Do not spin the wheels at over 34 mph (55 km/h). The tires may fail and injure a passenger or bystander.

Four-Wheel Drive (If Equipped)

If your vehicle gets stuck in mud or snow you can rock it out by shifting between forward and reverse gears, stopping between shifts, in a steady pattern. Press lightly on the accelerator in each gear.

If your vehicle comes with AdvanceTrac® with Roll Stability Control™, it could be beneficial to disengage the AdvanceTrac® with Roll Stability Control™ system while attempting to rock the vehicle.

Note: Do not rock the vehicle if the engine is not at normal operating temperature or damage to the transmission could occur.

Note: Do not rock the vehicle for more than a few minutes or damage to the transmission and tires could occur or the engine could overheat.

Emergency Maneuvers

- In an unavoidable emergency situation where a sudden sharp turn must be made, remember to avoid "over-driving" your vehicle (for example, turn the steering wheel only as rapidly and as far as required to avoid the emergency). Excessive steering can result in less vehicle control, not more. Additionally, smooth variations of the accelerator and/or brake pedal pressure should be utilized if changes in vehicle speed are called

for. Avoid abrupt steering, acceleration or braking which could result in an increased risk of loss of vehicle control, vehicle rollover and/or personal injury. Use all available road surface to return the vehicle to a safe direction of travel.

- In the event of an emergency stop, avoid skidding the tires and do not attempt any sharp steering wheel movements.
- If the vehicle goes from one type of surface to another (i.e., from concrete to gravel) there is a change in the way the vehicle responds to a maneuver (steering, acceleration or braking). Again, avoid these abrupt inputs.

Sand

When driving over sand, try to keep all four wheels on the most solid area of the trail. Avoid reducing the tire pressures but shift to a lower gear and drive steadily through the terrain. Apply the accelerator slowly and avoid spinning the wheels.

Avoid excessive speed because vehicle momentum can work against you and cause the vehicle to become stuck to the point that assistance could be required from another vehicle. Remember, you could be able to back out the way you came if you proceed with caution.

Mud and Water

If you must drive through high water, drive slowly. Traction or brake capability could be limited.

Note: Driving through deep water could damage your vehicle.

When driving through water, determine the depth; avoid water higher than the bottom of the hubs (if possible) and proceed slowly. If the ignition system gets wet, the vehicle could stall.

Four-Wheel Drive (If Equipped)

Once through water, always try the brakes. Wet brakes do not stop the vehicle as effectively as dry brakes. Drying can be improved by moving your vehicle slowly while applying light pressure on the brake pedal.

Be cautious of sudden changes in vehicle speed or direction when you are driving in mud. Even 4WD vehicles can lose traction in slick mud. As when you are driving over sand, apply the accelerator slowly and avoid spinning your wheels. If the vehicle does slide, steer in the direction of the slide until you regain control of the vehicle.

After driving through mud, clean off residue stuck to rotating driveshafts and tires. Excess mud stuck on tires and rotating driveshafts causes an imbalance that could damage drive components.



“Tread Lightly” is an educational program designed to increase public awareness of land-use regulations and responsibilities in our nation’s wilderness areas. Ford Motor Company joins the U.S. Forest Service and the Bureau of Land Management in encouraging you to help preserve our national forest and other public and private lands by “treading lightly.”

Driving on Hilly or Sloping Terrain

Although natural obstacles could make it necessary to travel diagonally up or down a hill or steep incline, you should always try to drive straight up or straight down.

Note: Avoid driving crosswise or turning on steep slopes or hills. A danger lies in losing traction, slipping sideways and possibly rolling over. Whenever driving on a hill, determine beforehand the route you will use. Do not drive over the crest of a hill without seeing what conditions are on the other side. Do not drive in reverse over a hill without the aid of an observer.

When climbing a steep slope or hill, start in a lower gear rather than downshifting to a lower gear from a higher gear once the ascent has started. This reduces strain on the engine and the possibility of stalling.

If you do stall out, do not try to turn around because you might roll over. It is better to back down to a safe location.

Apply just enough power to the wheels to climb the hill. Too much power can cause the tires to slip, spin or lose traction, resulting in loss of vehicle control.



Descend a hill in the same gear you would use to climb up the hill to avoid excessive brake application and brake overheating. Do not descend in neutral; instead, disengage overdrive or manually shift to a lower gear. When descending a steep hill, avoid sudden hard braking as you could lose control. The front wheels have to be turning in order to steer the vehicle.

Four-Wheel Drive (If Equipped)

Your vehicle has anti-lock brakes, therefore apply the brakes steadily. Do not “pump” the brakes.

Driving on Snow and Ice



WARNING: If you are driving in slippery conditions that require tire chains or cables, then it is critical that you drive cautiously. Keep speeds down, allow for longer stopping distances and avoid aggressive steering to reduce the chances of a loss of vehicle control which can lead to serious injury or death. If the rear end of your vehicle slides while cornering, steer in the direction of the slide until you regain control of your vehicle.

Note: Excessive tire slippage can cause driveline damage.

4WD vehicles have advantages over 2WD vehicles in snow and ice but can skid like any other vehicle.

Should you start to slide while driving on snowy or icy roads, turn the steering wheel in the direction of the slide until you regain control.

Avoid sudden applications of power and quick changes of direction on snow and ice. Apply the accelerator slowly and steadily when starting from a full stop.

Avoid sudden braking as well. Although a 4WD vehicle could accelerate better than a two-wheel drive vehicle in snow and ice, it will not stop any faster, because as in other vehicles, braking occurs at all four wheels. Do not become overconfident as to road conditions.

Make sure you allow sufficient distance between you and other vehicles for stopping. Drive slower than usual and consider using one of the lower gears. In emergency stopping situations, apply the brake steadily. Since your vehicle comes with a four wheel (ABS), do not “pump” the brakes. See **Hints on Driving With Anti-Lock Brakes** (page 211).

Maintenance and Modifications

The suspension and steering systems on your vehicle have been designed and tested to provide predictable performance whether loaded or empty and durable load carrying capability. For this reason, we strongly recommend that you do not make modifications such as adding or removing parts (such as lowering kits or stabilizer bars) or by using replacement parts not equivalent to the original factory equipment.

Any modifications to a vehicle that raise the center of gravity can make it more likely the vehicle will rollover as a result of a loss of control. We strongly recommend that caution be used with any vehicle equipped with a high load or device (such as ladder or luggage racks).

Failure to maintain your vehicle properly could void the warranty, increase your repair cost, reduce vehicle performance and operational capabilities and adversely affect driver and passenger safety. Frequent inspection of vehicle chassis components is recommended if the vehicle is subjected to off-highway usage.

Rear Axle

LIMITED SLIP DIFFERENTIAL

(IF EQUIPPED)

This axle provides added traction on slippery surfaces, particularly when one wheel is on a poor traction surface. Under normal conditions, the limited-slip axle functions like a standard rear axle. The axle may exhibit a slight noise or vibration during tight turns with low vehicle speed. This is normal behavior and indicates the axle is working.

Brakes

GENERAL INFORMATION

Note: Occasional brake noise is normal. If a metal-to-metal, continuous grinding or continuous squeal sound is present, the brake linings may be worn. Have your vehicle checked. If the vehicle has continuous vibration or shudder in the steering wheel while braking, have your vehicle checked.

Note: Brake dust may accumulate on the wheels, even under normal driving conditions. Some dust is inevitable as the brakes wear and does not contribute to brake noise. Wet brakes result in reduced braking efficiency. Gently press the brake pedal a few times when driving from a car wash or standing water to dry the brakes.

See **Cleaning the Wheels** (page 344).

Brake Over Accelerator

In the event the accelerator pedal becomes stuck or entrapped, apply steady and firm pressure to the brake pedal to slow the vehicle and reduce engine power. If you experience this condition, apply the brakes and bring your vehicle to a safe stop. Switch the engine off, move the transmission to park (P) and apply the parking brake. Inspect the accelerator pedal and the area around it for any items or debris that may be obstructing its movement. If none are found and the condition persists, have your vehicle checked. If your vehicle has to be towed, we recommend that you contact a professional towing service.

Emergency Brake Assist

Emergency brake assist detects when you brake heavily by measuring the rate at which you press the brake pedal. It provides maximum braking efficiency as long as you press the pedal. Emergency brake assist can reduce stopping distances in critical situations.

Anti-lock Brake System

This system helps you maintain steering control during emergency stops by keeping the brakes from locking.



This lamp illuminates momentarily when you switch the ignition on to confirm the lamp is functional.

If the warning lamp does not illuminate during start up, remains on or flashes, the system may be disabled. Have the system checked. If the anti-lock brake system is disabled, normal braking is still operational.

See **Warning Lamps and Indicators** (page 105).

Note: Indicators vary depending on region.



This lamp illuminates momentarily when you switch the ignition on to confirm the lamp is functional. If it does not illuminate when you switch the ignition on, or if it begins to flash at any time except the time during applying or releasing the parking brake, have the system checked.

Regenerative Braking System

This feature simulates the engine braking of an internal combustion engine and assist the standard brake system while recovering some of the energy of motion and storing it in the battery to improve fuel economy. The standard brake system is designed to fully stop the car if regenerative braking is not available. During regenerative braking, the motor is spun as a generator to create electrical current. This recharges the battery and slows the vehicle. Once the accelerator pedal is released, the motor changes from an energy user to an energy producer.

Brakes

When you release the accelerator pedal or press the brake pedal, the brake controller automatically detects the amount of deceleration requested and optimizes how much of the deceleration will be produced by regenerative braking. The remaining portion is generated by standard friction braking. When the battery is almost fully charged, the amount of regenerative braking is limited to avoid overcharging, and the requested deceleration is produced by standard friction braking alone.

Regenerative braking does not take the place of the standard friction brakes; it only assists them. Regenerative braking is designed to interact with the anti-lock brake system. Regenerative braking disables when the anti-lock brake system is activated or the battery is fully charged.

HINTS ON DRIVING WITH ANTI-LOCK BRAKES

The anti-lock brake system does not eliminate the risks when:

- You drive too closely to the vehicle in front of you.
- Your vehicle is hydroplaning.
- You take corners too fast.
- The road surface is poor.

Note: *If the system activates, the brake pedal could pulse and may travel further. Maintain pressure on the brake pedal. You may also hear a noise from the system. This is normal.*

ELECTRIC PARKING BRAKE



WARNING: Apply the parking brake and shift into park (P) before leaving your vehicle.



WARNING: If you drive extended distances with the parking brake applied, you could cause damage to the brake system.



WARNING: The electric parking brake does not operate if the vehicle battery has run out of charge.

Your vehicle has an electric parking brake. You operate it with a switch instead of a lever. The switch is on the center console or to the left-hand side of the steering wheel, on the lower part of the instrument panel.

Note: *The electric parking brake makes noises during operation. This is normal.*

Applying the Electric Parking Brake



Pull the switch up.



The red warning lamp flashes during operation and illuminates when the parking brake is applied.



Note: *It remains illuminated for a short period of time after you switch the ignition off.*

If it continues to flash or does not illuminate, the system has malfunctioned. Have your vehicle checked as soon as possible.

Note: *You can apply the electric parking brake when the ignition is off.*

Brakes

Note: If you shift your vehicle into park (P) on a slope and the transmission cannot securely hold the vehicle, the electric parking brake automatically applies. See **Transmission** (page 197).

Applying the Electric Parking Brake in an Emergency

Note: Do not apply the electric parking brake when your vehicle is moving, except in an emergency. If you repeatedly use the electric parking brake to slow or stop your vehicle, you could cause damage to the brake system.

You can use the electric parking brake to slow or stop your vehicle in an emergency.



Pull the switch up and hold it.



The red warning lamp illuminates, a tone sounds and the stoplamps turn on.



The electric parking brake continues to slow your vehicle down unless you release the switch.

Manually Releasing the Electric Parking Brake

Switch the ignition on.

Press and hold the brake pedal.



Push the switch down.



The red warning lamp turns off.



If it remains illuminated or flashes, the system has malfunctioned. Have your vehicle checked as soon as possible.

Pulling Away on a Hill When Towing a Trailer

Press and hold the brake pedal.



Pull the switch up and hold it.

Shift into gear.

Press the accelerator pedal until the engine has developed sufficient torque to prevent your vehicle from rolling down the hill.



Release the switch and pull away in a normal manner.

Automatically Releasing the Electric Parking Brake

Close the driver door.

Shift into gear.

Press the accelerator pedal and pull away in a normal manner.



The red warning lamp turns off.



If it remains illuminated or flashes, the electric parking brake has not released. Manually release the parking brake.

Releasing the Electric Parking Brake if the Vehicle Battery is Running Out of Charge

Connect a booster battery to the vehicle battery to release the electric parking brake if the vehicle battery is running out of charge. See **Jump Starting the Vehicle** (page 293).

Brakes

HILL START ASSIST



WARNING: The system does not replace the parking brake. When you leave your vehicle, always apply the parking brake.



WARNING: You must remain in your vehicle when the system turns on. At all times, you are responsible for controlling your vehicle, supervising the system and intervening, if required. Failure to take care may result in the loss of control of your vehicle, serious personal injury or death.



WARNING: The system will turn off if a malfunction is apparent or if you rev the engine excessively. Failure to take care may result in the loss of control of your vehicle, serious personal injury or death.

The system makes it easier to pull away when your vehicle is on a slope without the need to use the parking brake.

When the system is active, your vehicle remains stationary on the slope for two to three seconds after you release the brake pedal. This allows time to move your foot from the brake to the accelerator pedal. The system releases the brakes automatically once the engine has developed sufficient torque to prevent your vehicle from rolling down the slope. This is an advantage when pulling away on a slope, for example from a car park ramp, traffic lights or when reversing uphill into a parking space.

The system activates on any slope that causes your vehicle to roll.

Note: *There is no warning light to indicate the system is either on or off.*

Using Hill Start Assist

1. Press the brake pedal to bring your vehicle to a complete standstill. Keep the brake pedal pressed and shift into first gear when facing uphill or reverse (R) when facing downhill.
2. If the sensors detect that your vehicle is on a slope, the system activates automatically.
3. When you remove your foot from the brake pedal, your vehicle remains on the slope without rolling away for about two to three seconds. This hold time automatically extends if you are in the process of driving off.
4. Drive off in the normal manner. The system releases the brakes automatically.

Note: *When you remove your foot from the brake pedal and press the pedal again when the system is active, you will experience significantly reduced brake pedal travel. This is normal.*

Switching the System On and Off

Vehicles with Manual Transmission

You can switch this feature on or off in the information display. The system remembers the last setting when you start your vehicle.

Vehicles with Automatic Transmission

You cannot turn the system on or off. When you switch the ignition on, the system automatically turns on.

Brakes

AUTO HOLD



WARNING: The system does not replace the parking brake. When you leave your vehicle, always apply the parking brake.



WARNING: You must remain in your vehicle when the system turns on. At all times, you are responsible for controlling your vehicle, supervising the system and intervening, if required. Failure to take care may result in the loss of control of your vehicle, serious personal injury or death.



WARNING: The system turns off if there is a malfunction.

The system is designed to apply the brakes to hold your vehicle at a standstill after you stop your vehicle and release the brake pedal. This could be beneficial in certain situations, for example when waiting on a hill or in traffic.

Switching Auto Hold On and Off



Press the button on the center console. The button illuminates when you switch the system on.

Note: You can only switch the system on after you close the driver door, and start the engine.

Note: The system remembers the last setting when you start your vehicle.

Make sure you switch the system off before towing with your vehicle or before using an automatic car wash.

Using Auto Hold

1. Use the brakes to bring your vehicle to a complete stop. The auto hold active indicator illuminates in the information display.

2. Release the brake pedal. The system holds your vehicle at a standstill. The auto hold active indicator remains illuminated in the information display.

Note: The system only activates if you apply enough brake pressure. If your vehicle is on a steep slope, you might need to press the brake pedal harder before the system activates.

Note: Under certain conditions, the system could apply the electric parking brake. The brake system warning lamp illuminates. The electric parking brake releases when you press the accelerator pedal. See **Electric Parking Brake** (page 211).

Note: If auto-start-stop turns off the engine, auto hold remains active.

Note: The system deactivates if you shift into reverse (R) and press the brake pedal.

3. Pull away in the normal manner. The system releases the brakes and the auto hold active indicator turns off.

Auto Hold Indicator

The auto hold indicator illuminates in the information display when the system is on and is either active or unavailable.



Illuminates when the system is active. Your vehicle remains stationary after you release the brake pedal.



Illuminates when the system is on but unavailable to hold your vehicle at a standstill.



The system could be unavailable when any of the following occur:

- During an active park assist maneuver.
- Your vehicle is in stay in neutral mode.

Brakes

- The driver door is open.
- You shift into reverse (R) before the system is active.

Reverse Braking Assist (If Equipped)

WHAT IS REVERSE BRAKING ASSIST

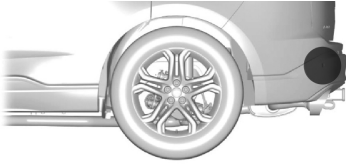

Reverse braking assist is designed to reduce impact damage or assist in avoiding a collision while in reverse (R). Using sensors on the rear of the vehicle, it can detect a possible collision and apply the brakes. If full braking occurs, the system attempts to stop the vehicle a safe distance from the obstacle.

REVERSE BRAKING ASSIST PRECAUTIONS

WARNING: You are responsible for controlling your vehicle at all times. The system is designed to be an aid and does not relieve you of your responsibility to drive with due care and attention. Failure to follow this instruction could result in the loss of control of your vehicle, personal injury or death.

WARNING: To help avoid personal injury, always use caution when in reverse (R) and when using the sensing system.

WARNING: The system may not operate properly during severe weather conditions, for example snow, ice, heavy rain and spray. Always drive with due care and attention. Failure to take care may result in a crash.

WARNING: Traffic control systems, fluorescent lamps, inclement weather, air brakes, external motors and fans may affect the correct operation of the sensing system. This may cause reduced performance or false alerts.

WARNING: Some situations and objects prevent hazard detection. For example low or direct sunlight, inclement weather, unconventional vehicle types, and pedestrians. Apply the brakes when necessary. Failure to follow this instruction could result in the loss of control of your vehicle, personal injury or death.

WARNING: Do not use the system with accessories that extend beyond the front or rear of your vehicle, for example a trailer hitch or bike rack. The system is not able to make corrections for the additional length of the accessories.

The system only applies the brakes for a short period of time when an event occurs. Act as soon as you notice the brakes apply to remain in control of the vehicle. If you do not intervene the vehicle may start to move again.

Note: *Certain add-on devices around the bumper or fascia may create false alerts. For example, large trailer hitches, bicycle or surfboard racks, license plate brackets, bumper covers or any other device that may block the normal detection zone of the system. Remove the add-on device to prevent false alerts.*

Note: *The system does not react to small or moving objects, particularly those close to the ground.*

Note: *The system does not operate during hard acceleration or steering.*

Reverse Braking Assist (If Equipped)

Note: If your vehicle sustains damage to the bumper or fascia leaving it misaligned or bent, it could alter the sensing zone causing inaccurate measurement of obstacles or false alerts.

Note: Vehicle loading and suspension changes can impact the angle of the sensors and may change the normal detection zone of the system resulting in inaccurate measurement of obstacles or false alerts.

Note: When you connect a trailer, the system may detect the trailer and provide an alert, or the system turns off. If the system does not turn off, manually switch the system off after you connect the trailer.

Note: You may experience reduced system performance on road surfaces that limit deceleration. For example, roads with ice, loose gravel, mud or sand.

SWITCHING REVERSE BRAKING ASSIST ON AND OFF

You can switch the system on or off through the touchscreen. See **Settings** (page 458).

Note: The system is unavailable when rear parking aid or cross traffic alert is off.

OVERRIDING REVERSE BRAKING ASSIST

There could be instances when unexpected or unwanted braking occurs. Firmly pressing the accelerator pedal or switching the feature off overrides the system.

REVERSE BRAKING ASSIST INDICATORS

If the system determines that a collision with an obstacle may occur, full braking may apply.



A message and warning indicator appear when the system applies the brakes.

Reverse Braking Assist (If Equipped)

REVERSE BRAKING ASSIST – TROUBLESHOOTING

REVERSE BRAKING ASSIST – INFORMATION MESSAGES

Message	Description
Reverse Brake Assist	Displays when the system applies the brakes and remains on for a few seconds.
Reverse Brake Assist Not Available See Manual	Make sure that all doors, liftgate or tailgate and hood are closed. Drive the vehicle on a straight road for a short period. Make sure the parking aids and cross traffic alert systems are on. If the message remains on, have the system checked as soon as possible.
Reverse Brake Assist Fault	Displays when a system error has occurred. Have your vehicle checked as soon as possible.
Reverse Brake Assist Off	Displays when reverse brake assist is off.

Reverse Braking Assist (If Equipped)

REVERSE BRAKING ASSIST – FREQUENTLY ASKED QUESTIONS

Why is reverse braking assist unavailable?

- Make sure you switch the system on. See **Switching Reverse Braking Assist On and Off** (page 217).
- Make sure that the liftgate, hood and all doors are closed.
- Make sure the cross traffic alert system is on. See **Cross Traffic Alert** (page 263).
- Make sure the rear parking aid system is on. See **Rear Parking Aid** (page 225).
- Make sure traction control is on. See **Using Traction Control** (page 220).
- The vehicle has sustained a rear end impact. Have the sensors checked for proper coverage and operation.
- An ABS, traction control or stability control event may have occurred. The system resumes operation when the event is complete.
- Make sure the rear view camera and 360 degree camera are not dirty or obstructed. If it is dirty, clean the camera. See **Rear View Camera** (page 234). See **360 Degree Camera** (page 237). If the message still appears after cleaning the camera, wait a short time and the message should clear. If the message does not clear, have the system checked.
- Make sure the sensors are not blocked or faulted. See **Cross Traffic Alert** (page 263). See **Rear Parking Aid** (page 225).

- You recently had your vehicle serviced, or the battery disconnected. Drive your vehicle a short distance to resume system operation.
- The system does not function when you connect a trailer. Operation resumes when you disconnect the trailer.

Note: *If the answers to why the system is unavailable do not assist in returning reverse braking assist to available, have the system checked as soon as possible.*

Traction Control

PRINCIPLE OF OPERATION

The traction control system helps avoid drive wheel spin and loss of traction.

If your vehicle begins to slide, the system applies the brakes to individual wheels and, when needed, reduces engine power at the same time. If the wheels spin when accelerating on slippery or loose surfaces, the system reduces engine power in order to increase traction.

USING TRACTION CONTROL



WARNING: Operating your vehicle with the traction control disabled could lead to an increased risk of loss of vehicle control, vehicle rollover, personal injury and death.

The system automatically turns on each time you switch the ignition on.

If your vehicle is stuck in mud or snow, switching traction control off may be beneficial as this allows the wheels to spin.

Note: *When you switch traction control off, stability control remains fully active.*

Switching the System Off

When you switch the system off or on, a message appears in the information display showing system status.

You can switch the system off by using the switch.

Using a Switch (If Equipped)

Use the traction control switch on the center console near the shifter to switch the system off or on.



The traction control switch.

System Indicator Lights and Messages



The stability and traction control light:

- Temporarily illuminates on engine start-up.
- Flashes when a driving condition activates either of the systems.
- Illuminates if a problem occurs in either of the systems.



The stability and traction control off light temporarily illuminates on engine start-up and stays on when you switch the traction control system off.

Stability Control

PRINCIPLE OF OPERATION



WARNING: Vehicle modifications involving braking system, aftermarket roof racks, suspension, steering system, tire construction and wheel and tire size may change the handling characteristics of your vehicle and may adversely affect the performance of the electronic stability control system. In addition, installing any stereo loudspeakers may interfere with and adversely affect the electronic stability control system. Install any aftermarket stereo loudspeaker as far as possible from the front center console, the tunnel, and the front seats in order to minimize the risk of interfering with the electronic stability control sensors. Reducing the effectiveness of the electronic stability control system could lead to an increased risk of loss of vehicle control, vehicle rollover, personal injury and death.



WARNING: Remember that even advanced technology cannot defy the laws of physics. It's always possible to lose control of a vehicle due to inappropriate driver input for the conditions. Aggressive driving on any road condition can cause you to lose control of your vehicle increasing the risk of personal injury or property damage. Activation of the electronic stability control system is an indication that at least some of the tires have exceeded their ability to grip the road; this could reduce the operator's ability to control the vehicle potentially resulting in a loss of vehicle control, vehicle rollover, personal injury and death. If your electronic stability control system activates, SLOW DOWN.

The system automatically turns on each time you switch the ignition on.

If a driving condition activates either the stability control or the traction control system you may experience the following conditions:

- The stability and traction control light flashes.
- Your vehicle slows down.
- Reduced engine power.
- A vibration in the brake pedal.
- The brake pedal is stiffer than usual.
- If the driving condition is severe and your foot is not on the brake, the brake pedal may move as the systems applies higher brake forces.

The stability control system has several features built into it to help you maintain control of your vehicle:

Electronic Stability Control

The system enhances your vehicle's ability to prevent skids or lateral slides by applying brakes to one or more of the wheels individually and, if necessary, reducing engine power.

Roll Stability Control

The system enhances your vehicle's ability to prevent rollovers by detecting your vehicle's roll motion and the rate at which it changes by applying the brakes to one or more wheels individually.

Curve Control

The system enhances your vehicle's ability to follow the road when cornering severely or avoiding objects in the roadway. Curve Control operates by reducing engine power and, if necessary, applying brakes to one or more of the wheels individually.

Stability Control

Traction Control

The system enhances your vehicle's ability to maintain traction of the wheels by detecting and controlling wheel spin. See **Using Traction Control** (page 220).

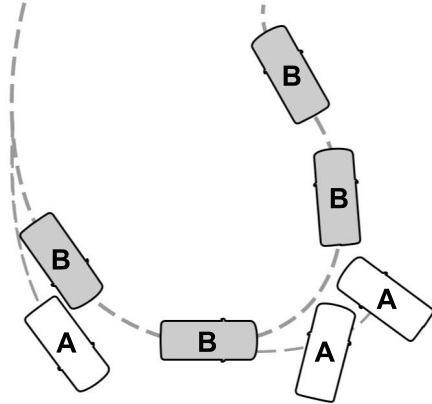

- A Vehicle without stability control skidding off its intended route.
- B Vehicle with stability control maintaining control on a slippery surface.

USING STABILITY CONTROL

Electronic Stability Control - Base Model

The system automatically turns on each time you switch the ignition on.

You cannot switch the stability control and roll stability control systems off, but when you shift into reverse (R), the systems deactivate.

You can switch the traction control system off or on. See **Using Traction Control** (page 220).

Electronic Stability Control - ST Model



The system turns on each time you switch the ignition on. You can switch off the traction control portion of the system independently. See **Using Traction Control** (page 220).

Stability Control

ESC Features for ST model				
Button Functions	Mode	Stability Control Off Light	Electronic Stability Control	Traction Control System
Default at start-up	Default - Traction Control On and Normal AdvanceTrac	On during bulb check	Enabled	Enabled
Button momentarily pressed - single press	Traction Control Off	On	Enabled	Disabled
Button pressed and held for five seconds	AdvanceTrac Off	On	Disabled	Disabled
Button pressed when in Traction Control Off or AdvanceTrac Off	Return to Default	Off	Enabled	Enabled

Note: Do not use the AdvanceTrac Off setting on public roadways.

Hill Descent Control

WHAT IS HILL DESCENT CONTROL



WARNING: Hill descent control cannot control descent in all surface conditions and circumstances, such as ice or extremely steep grades. Hill descent control is a driver assist system and cannot substitute for good judgment by the driver. Failure to do so may result in loss of vehicle control, crash or serious injury.



WARNING: The system does not replace the parking brake. When you leave your vehicle, always apply the parking brake.

Note: *The system does not function below 3 mph (5 km/h).*

Hill descent control allows the driver to set and maintain vehicle speed while descending steep slopes in various surface conditions.

The system can maintain vehicle speeds on downhill slopes between 3–20 mph (5–32 km/h). Above 20 mph (32 km/h), the system remains on but the descent speed cannot be set or maintained.

The system requires a cool down interval after a period of sustained use. The amount of time that the system can remain active before cooling varies with conditions. The system provides a warning in the message center and a tone sounds when the system is about to disengage for cooling. At this time, manually apply the brakes as needed to maintain descent speed.

SWITCHING HILL DESCENT CONTROL ON AND OFF



Press the button on the center console. A light illuminates in the control and a tone sounds when the system is active.

SETTING THE HILL DESCENT SPEED



WARNING: The system does not replace the parking brake. When you leave your vehicle, always apply the parking brake.



WARNING: The system does not control speed in low traction conditions or extremely steep slopes. The system is designed to be an aid and does not relieve you of your responsibility to drive with due care and attention. Failure to follow this instruction could result in personal injury.

To increase the descent speed, press the accelerator pedal until you reach the speed you prefer.

To decrease the descent speed, press the brake pedal until you reach the speed you prefer.

When you reach the speed you prefer, either by accelerating or decelerating, remove your feet from the pedals. The system maintains the chosen vehicle speed.

HILL DESCENT CONTROL INDICATOR



Illuminates when you switch hill descent control on.

Parking Aids

PRINCIPLE OF OPERATION



WARNING: To help avoid personal injury, always use caution when in reverse (R) and when using the sensing system.



WARNING: The system may not detect objects with surfaces that absorb reflection. Always drive with due care and attention. Failure to take care may result in a crash.



WARNING: Traffic control systems, inclement weather, air brakes, external motors and fans may affect the correct operation of the sensing system. This may cause reduced performance or false alerts.



WARNING: The system may not detect small or moving objects, particularly those close to the ground.

Note: If your vehicle has MyKey™, the sensing system cannot be switched off when a MyKey™ is present. See **Principle of Operation** (page 64).

Note: Keep the sensors on the bumper or fascia free from snow, ice and large accumulations of dirt. If the sensors are covered, the system's accuracy can be affected. Do not clean the sensors with sharp objects.

Note: If your vehicle sustains damage to the bumper or fascia, leaving it misaligned or bent, the sensing zone may be altered causing inaccurate measurement of obstacles or false alerts.

Note: Certain add-on devices installed around the bumper or fascia may create false alerts. For example, large trailer hitches, bike or surfboard racks, license plate brackets, bumper covers or any other device that may block the normal detection zone of the system. Remove the add-on device to prevent false alerts.

Note: When you connect a trailer to your vehicle, the rear parking aid may detect the trailer and therefore provide an alert. Disable the rear parking aid when you connect a trailer to prevent the alert.

The sensing system warns the driver of obstacles within a certain range of your vehicle. The system turns on automatically whenever you switch the ignition on.

You can switch the system off through the touchscreen, information display or from the pop-up message that appears once you shift the transmission into reverse (R). If your vehicle has a parking aid button, you can switch the system off by pressing the button.

If a fault is present in the system, a warning message appears in the information display. See **Information Messages** (page 119).

REAR PARKING AID



WARNING: The system may not detect objects with surfaces that absorb reflection. Always drive with due care and attention. Failure to take care may result in a crash.



WARNING: The system may not detect small or moving objects, particularly those close to the ground.

Parking Aids



WARNING: To help avoid personal injury, always use caution when in reverse (R) and when using the sensing system.



WARNING: The parking aid system can only assist you to detect objects when your vehicle is moving at parking speeds. To help avoid personal injury you must take care when using the parking aid system.

Note: Keep the sensors free from snow, ice and large accumulations of dirt.

Note: Do not cover up the sensors.

Note: Do not clean the sensors with sharp objects.

Note: If your vehicle sustains damage leaving the sensors misaligned, this may cause inaccurate measurements or false alerts.

Note: Some accessories, for example large trailer hitches or bike or surfboard racks, can cause reduced performance or false alerts.

The sensors are on the rear bumper.

The sensors are active when the transmission is in reverse (R) and the vehicle speed is less than 5 mph (8 km/h). When the parking aid system sounds a tone, the audio system may reduce the set volume.

A warning tone sounds when your vehicle approaches an object. As your vehicle moves closer to an object, the rate of the tone increases. The warning tone continuously sounds when an object is 12 in (30 cm) or less from the center of the rear bumper.

Note: There is a decreased coverage area at the outer corners.



The sensor coverage area is up to 70 in (180 cm) from the rear bumper.

If the system detects a fault, a warning message appears in the information display.

The system detects large objects when you shift into reverse (R) and any of the following occur:

- Your vehicle is moving backward at low speed.
- Your vehicle is stationary, but an object is approaching the rear of your vehicle at low speed.
- Your vehicle is moving backward at low speed and an object is moving toward your vehicle, for example another vehicle, at low speed.

If your vehicle remains stationary for two seconds, the audible warning turns off. If your vehicle moves backward, the tone sounds again.

Note: If the detected object is 12 in (30 cm) or less from the rear bumper, the audible warning does not turn off.

Parking Aids

Object Distance Indicator (If Equipped)

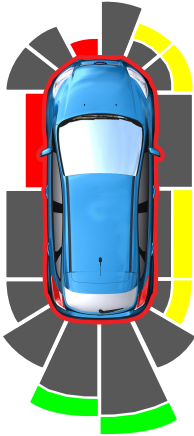

The system provides object distance indication through the information display.

- As the distance to the object decreases, the indicator blocks illuminate and move toward the vehicle icon.
- If the system does not detect an object, the distance indicator blocks are gray.

When you shift into reverse (R), the system provides audible warnings and visual indication when your vehicle is moving, and the detected object is moving toward your vehicle. When you stop your vehicle, the audible warnings stop after two seconds. Visual indication remains on when the transmission is in reverse (R).

FRONT PARKING AID (IF EQUIPPED)

WARNING: The system may not detect objects with surfaces that absorb reflection. Always drive with due care and attention. Failure to take care may result in a crash.

WARNING: The system may not detect small or moving objects, particularly those close to the ground.

WARNING: To help avoid personal injury, always use caution when in reverse (R) and when using the sensing system.

WARNING: The parking aid system can only assist you to detect objects when your vehicle is moving at parking speeds. To help avoid personal injury you must take care when using the parking aid system.

Note: Keep the sensors free from snow, ice and large accumulations of dirt.

Note: Do not cover up the sensors.

Note: Do not clean the sensors with sharp objects.

Note: If your vehicle sustains damage leaving the sensors misaligned, this may cause inaccurate measurements or false alerts.

Note: Some accessories, for example large trailer hitches or bike or surfboard racks can cause reduced performance or false alerts.

The sensors are on the front bumper.

The sensors are active when the transmission is in any position other than park (P). When the parking aid system sounds a tone, the audio system may reduce the set volume.

Parking Aids

A warning tone sounds when your vehicle approaches an object. As your vehicle moves closer to an object, the rate of the tone increases. The warning tone continuously sounds when an object is 12 in (30 cm) or less from the front bumper.

Note: *There is a decreased coverage area at the outer corners.*

The system turns off when the vehicle speed reaches 5 mph (8 km/h).



The sensor coverage area is up to 28 in (70 cm) from the center of the bumper.

If the transmission is in reverse (R), the system detects objects when your vehicle is moving at low speed or an object is moving toward your vehicle, for example another vehicle at low speed. When you stop your vehicle, the audible warning turns off after two seconds.

If the transmission is in any forward gear, the system provides audible warnings when your vehicle is moving and an object is within the detection area. When you stop your vehicle, the audible warning turns off after two seconds and the visual warning turns off after four seconds.

If the system detects a fault, a warning message appears in the information display.

Object Distance Indicator (If Equipped)

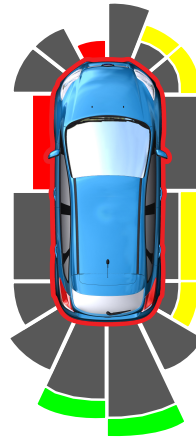

The system provides object distance indication through the information display.

- As the distance to the object decreases, the indicator blocks illuminate and move toward the vehicle icon.
- If there is no object detected, the distance indicator blocks are gray.

When you shift into any forward gear, the system provides audible warnings and visual indication when your vehicle is moving at a speed of approximately 5 mph (8 km/h) or below and the system detects an object within the detection zone. When you stop your vehicle, the audible warnings stop after two seconds and visual indication stops after four seconds.

Note: *If the detected object is 12 in (30 cm) or less from your vehicle, visual indication remains on.*

Parking Aids

When you shift into neutral (N), the system only provides visual indication if your vehicle is moving at a speed of approximately 5 mph (8 km/h) or below, for example, your vehicle is moving on a slope, and the system detects an object moving toward your vehicle. When you stop your vehicle, visual indication stops after four seconds.

SIDE SENSING SYSTEM (IF EQUIPPED)



WARNING: The system may not detect objects with surfaces that absorb reflection. Always drive with due care and attention. Failure to take care may result in a crash.



WARNING: The system may not detect small or moving objects, particularly those close to the ground.



WARNING: To help avoid personal injury, always use caution when in reverse (R) and when using the sensing system.



WARNING: The parking aid system can only assist you to detect objects when your vehicle is moving at parking speeds. To help avoid personal injury you must take care when using the parking aid system.

The system uses the front and rear outermost parking aid sensors to detect objects that are near to the sides of your vehicle. The system displays them on a virtual map in the information display as your vehicle moves past them.

The sensors are on the front and rear bumpers.

Note: Keep the sensors free from snow, ice and large accumulations of dirt.

Note: Do not cover up the sensors.

Note: Do not clean the sensors with sharp objects.

Note: If your vehicle sustains damage leaving the sensors misaligned, this may cause inaccurate measurements or false alerts.

The system may not function if:

- You switch the ignition on, off and back on within a few seconds.
- Your vehicle remains stationary for over two minutes.
- The anti-lock brake system activates.
- The traction control system activates.

Note: If you switch traction control off, the side sensing system also turns off.

Note: Some accessories, for example large trailer hitches or bike or surfboard racks can cause reduced performance or false alerts.

To reinitialize the system, you may have to drive your vehicle approximately 10 ft (3 m).



The sensor coverage area is up to 24 in (60 cm) from the side of your vehicle.

Parking Aids

When the system detects an object within the coverage area and the driving path of your vehicle, an audible warning sounds. As your vehicle moves closer to the object, the rate of the tone increases.

Note: *The system does not detect an object that is moving toward the side of your vehicle, for example another vehicle moving at low speed, if it does not pass a front or rear sensor.*

Object Distance Indicator (If Equipped)

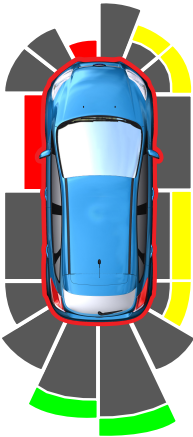

The system provides object distance indication through the information display.

- As the distance to the object decreases, the indicator blocks illuminate and move toward the vehicle icon.
- If there is no object detected, the distance indicator blocks are gray.

When you shift into reverse (R), the system provides audible warnings and a visual indication when detected objects are within 24 in (60 cm) and are inside the driving path of your vehicle. When you stop your vehicle, the audible warnings turn off after two seconds.

When you shift into any forward gear, the system provides audible warnings and a visual indication when your vehicle is moving at a speed of approximately 5 mph (8 km/h) or below and the system detects an object within the detection zone. When you stop your vehicle, the audible warnings turn off after two seconds and the visual indication turns off after four seconds.

When you shift into neutral (N), the system only provides a visual indication if your vehicle is moving at a speed of approximately 5 mph (8 km/h) or below. For example, your vehicle is moving on a slope, and the system detects an object moving toward your vehicle. When you stop your vehicle, the visual indication turns off after four seconds.

If the system is not available, the side distance indicator blocks do not display.

ACTIVE PARK ASSIST (IF EQUIPPED)

WARNING: You must remain in your vehicle when the system turns on. At all times, you are responsible for controlling your vehicle, supervising the system and intervening, if required. Failure to take care may result in the loss of control of your vehicle, serious personal injury or death.

WARNING: The sensors may not detect objects in heavy rain or other conditions that cause interference.

Parking Aids



WARNING: You are responsible for controlling your vehicle at all times. The system is designed to be an aid and does not relieve you of your responsibility to drive with due care and attention. Failure to follow this instruction could result in the loss of control of your vehicle, personal injury or death.



WARNING: Do not use the system with accessories that extend beyond the front or rear of your vehicle, for example a trailer hitch, bike rack or side mirror extensions such as telescoping mirrors or towing mirrors. The system is not able to make corrections for the additional length of the accessories.

The system assists parking into and out of parking spaces. It uses sensors to detect parking spaces. The system then steers, accelerates, brakes and shifts gear as required to maneuver into or out of a parking space.

Using Active Park Assist



The active park assist button is near the transmission selector on the center console.

Press the active park assist button to bring up full screen notifications. Press either the active park assist button or the soft keys on the display screen to switch between Parallel Park In, Perpendicular Park In or Parallel Park Out parking modes.

Driving into a Parking Space

Note: When parking perpendicularly, the system backs your vehicle into parking spaces.

1. Press the active park assist button.

Note: The system does not recognize parking space lines and centers your vehicle between objects.

Note: The system detects other vehicles and curbs to find a parking space.

Note: The system searches for parallel parking spaces on the passenger side. Press the active park assist button again to make the system search for perpendicular spaces.

2. Use the direction indicator lever to search for a parking space on the driver or passenger side of your vehicle.
3. Drive your vehicle approximately 3 ft (1 m) away from and parallel to the other parked vehicles when searching for a parking space.

Note: A tone sounds and a message appears in the information display when active park assist finds a suitable parking space.

4. Press and hold the brake pedal.
5. Release the steering wheel and shift into neutral (N).
6. Press and hold the active park assist button.
7. Release the brake pedal to allow the vehicle to park.

Note: When parallel parking between objects, the system parks closer to the object in front of your vehicle to allow easier access to your luggage compartment.

Note: When perpendicular parking, the system aligns the front end of your vehicle with the object next to it.

Note: When perpendicular parking, if the system detects only one object, it allows enough distance to open the door on either side.

Note: You can slow down your vehicle at any time by pressing the brake pedal.

Note: When parking is complete the vehicle shifts into park (P).

Parking Aids

Leaving a Parking Space

The system assists leaving only parallel parking spaces.

1. Press the active park assist button.
2. Use the direction indicator lever to choose the direction to leave.
3. Press and hold the brake pedal.
4. Release the steering wheel and shift into neutral (N).
5. Release the parking brake.
6. Press and hold the active park assist button.
7. Release the brake pedal to allow the vehicle to move.

Note: You can slow down your vehicle at any time by pressing the brake pedal.

Note: After the system drives your vehicle to a position where you can exit the parking space in a forward movement, a message appears instructing you to take full control of your vehicle.

Canceling Active Park Assist

To cancel parking assistance at any time, shift out of neutral (N).

Note: If you turn the steering wheel or open the driver door the parking assistance also cancels.

Pausing Active Park Assist

To pause parking assistance at any time, release the active park assist button.

The vehicle stops moving until you press and hold the active park assist button again.

Note: If you open the passenger or rear doors the parking assistance also pauses.

Active Park Assist Troubleshooting

Symptom	Possible Cause
The system does not correctly operate.	The system is unable to detect a vehicle, curb or object to park next to, or in-between. This could occur because of sensors not operating correctly, not enough room for your vehicle, or the traction control is off.
The system does not search for a parking space.	You may have switched traction control off.
	The transmission is in reverse (R). Your vehicle must be moving forward to be able to detect a parking space.
The system does not offer a parking space.	There could be blockage on the sensors. For example, snow, ice or large accumulations of dirt. Blocked sensors can affect how the system functions.
	The sensors in the front or rear bumper could be damaged.
	There is not enough room in the parking space for your vehicle to safely park.

Parking Aids

Symptom	Possible Cause
	There is not enough space for the parking maneuver on the opposite side of the parking space.
	The parking space is more than 5 ft (1.5 m) or less than 2 ft (0.5 m) away.
	The vehicle speed is greater than 22 mph (35 km/h) for parallel parking or greater than 19 mph (30 km/h) for perpendicular parking.
	You recently disconnected or replaced the battery. After you reconnect the battery you must drive your vehicle on a straight road for a short period of time.
The system does not correctly position your vehicle in a parking space.	An irregular curb along the parking space prevents the system from correctly aligning your vehicle.
	Vehicles or objects bordering the space may not be correctly parked.
	Your vehicle stopped too far past the parking space.
	The tires may not be correctly installed or maintained. For example, not inflated correctly, improper size, or of different sizes.
	A repair or alteration changes the detection capabilities.
	A parked vehicle has a high attachment. For example, a salt sprayer, snowplow or moving truck bed.
	The parking space length or position of parked objects changes after your vehicle passes the space.
	You are using a spare tire or a tire more significantly worn than the other tires.
	The temperature around your vehicle quickly changes. For example, driving from a heated garage into cold outside temperature, or after leaving a car wash.

Parking Aids

REAR VIEW CAMERA



WARNING: The rear view camera system is a reverse aid supplement device that still requires the driver to use it in conjunction with the interior and exterior mirrors for maximum coverage.



WARNING: Objects that are close to either corner of the bumper or under the bumper, might not be seen on the screen due to the limited coverage of the camera system.



WARNING: Reverse your vehicle slowly. Failure to follow this instruction could result in the loss of control of your vehicle, personal injury or death.



WARNING: Use caution when the rear cargo door is ajar. If the rear cargo door is ajar, the camera will be out of position and the video image may be incorrect. All guidelines disappear when the rear cargo door is ajar. Failure to follow this instruction could result in personal injury.



WARNING: Use caution when turning camera features on or off when the transmission is not in park (P). Make sure your vehicle is not moving.

Note: Some vehicles may not come equipped with guidelines.

The rear view camera system provides a video image of the area behind your vehicle.

During operation, lines appear in the display which represent your vehicle's path and proximity to objects behind your vehicle.



E253742

The camera is located on the luggage compartment door.

Using the Rear View Camera System

The rear view camera system displays what is behind your vehicle when you place the transmission in reverse (R).

Note: The reverse sensing system is not effective at speeds above 3 mph (5 km/h) and may not detect certain angular or moving objects.

The system uses three types of guides to help you see what is behind your vehicle:

- Active guidelines (if equipped): Show the intended path of your vehicle when reversing.
- Fixed guidelines: Show the actual path your vehicle is moving in while reversing in a straight line. This can be helpful when backing into a parking space or aligning your vehicle with another object behind you.
- Centerline: Helps align the center of your vehicle with an object (for example, a trailer).

Note: If the transmission is in reverse (R) and the luggage compartment door or liftgate is open, no rear view camera features will display.

Parking Aids

Note: When towing, the camera only sees what you are towing. This might not provide adequate coverage as it usually provides in normal operation and some objects might not be seen. In some vehicles, the guidelines may disappear when you connect the trailer tow connector.

The camera may not operate correctly under the following conditions:

- Nighttime or dark areas if one or both reverse lamps are not operating.
- Mud, water or debris obstructs the camera's view. Clean the lens with a soft, lint-free cloth and non-abrasive cleaner. You can also use the rear washer to clean the camera. See **Rear Window Wiper and Washers** (page 85).
- The rear of your vehicle is hit or damaged, causing the camera to become misaligned.

Camera System Settings

The rear view camera system settings can be accessed through the touchscreen. See **Settings** (page 458).

Camera Guidelines

Note: Active guidelines are only available when the transmission is in reverse (R).

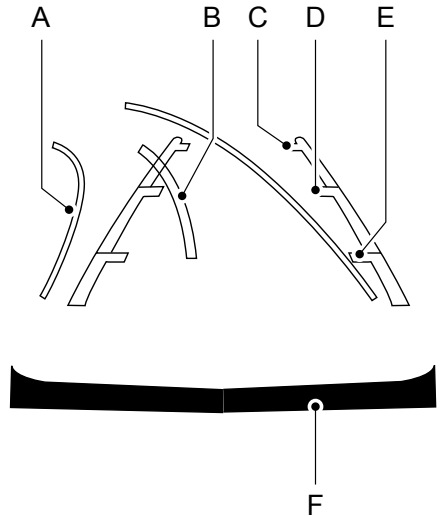

E142436

- A Active guidelines (If equipped)
- B Centerline
- C Fixed guideline: Green zone
- D Fixed guideline: Yellow zone
- E Fixed guideline: Red zone
- F Rear bumper

Active guidelines are only shown with fixed guidelines. To use active guidelines, turn the steering wheel to point the guidelines toward an intended path. If you change the steering wheel position while reversing, your vehicle might deviate from the original intended path.

Parking Aids

The fixed and active guidelines fade in and out depending on the steering wheel position. The active guidelines do not display when the steering wheel position is straight.

Always use caution while reversing. Objects in the red zone are closest to your vehicle and objects in the green zone are farther away. Objects are getting closer to your vehicle as they move from the green zone to the yellow or red zones. Use the side view mirrors and rear view mirror to get better coverage on both sides and rear of the vehicle.

Obstacle Distance Indicator (if

Equipped)

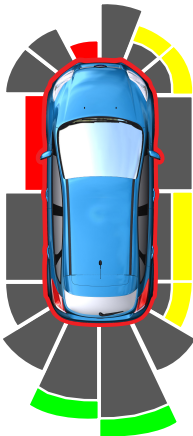

The system will provide an image of your vehicle and the sensor zones. The zones will highlight green, yellow and red when the parking aid sensors detect an object in the coverage area.

Manual Zoom



WARNING: When manual zoom is on, the full area behind your vehicle may not show. Be aware of your surroundings when using the manual zoom feature.

Note: *Manual zoom is only available when the transmission is in reverse (R).*

Note: *When you enable manual zoom, only the centerline is shown.*

Selectable settings for this feature are Zoom in (+) and Zoom out (-). Press the symbol in the camera screen to change the view. The default setting is Zoom OFF.

This allows you to get a closer view of an object behind your vehicle. The zoomed image keeps the bumper in the image to provide a reference. The zoom is only active while the transmission is in reverse (R).

Rear Camera Delay

Selectable settings for this feature are ON and OFF.

The default setting for the rear camera delay is OFF.

When shifting the transmission out of reverse (R) and into any gear other than park (P), the camera image remains in the display until:

- Your vehicle speed reaches approximately 5 mph (8 km/h).
- You shift your vehicle into park (P).

Parking Aids

360 DEGREE CAMERA (IF EQUIPPED)



WARNING: The 360 degree camera system still requires the driver to use it in conjunction with looking out of the windows, and checking the interior and exterior mirrors for maximum coverage.



WARNING: Objects that are close to either corner of the bumper or under the bumper, might not be seen on the screen due to the limited coverage of the camera system.



WARNING: Use caution when turning camera features on or off when the transmission is not in park (P). Make sure your vehicle is not moving.



WARNING: You are responsible for controlling your vehicle at all times. The system is designed to be an aid and does not relieve you of your responsibility to drive with due care and attention. Failure to follow this instruction could result in the loss of control of your vehicle, personal injury or death.

Note: Use caution using the 360 view when any of the doors are ajar. If a door is ajar, the camera becomes out of position and the video image could be incorrect.

The 360 degree camera system consists of front, side and rear cameras. The system:

- Allows you to see what is directly in front or behind your vehicle.
- Provides cross traffic view in front and behind your vehicle.

- Allows you to see a top-down view of the area outside your vehicle, including the blind spots.
- Provides you with visibility around your vehicle in parking maneuvers such as:
 - Centering in a parking space.
 - Obstacles near the vehicle.
 - Parallel parking.



The front camera enable button is near the display screen and turns on the front camera when your vehicle is not in reverse (R).

Using the System

Note: The 360 degree camera system turns off when your vehicle is in motion at low speed, except when in reverse (R).

The front and rear cameras have multiple screens which consist of normal view with 360, normal view, and split view. When in park (P), neutral (N) or drive (D), only the front images display when you press the button. When in reverse (R), only the rear images display.



Press to access the different camera views.



Normal + 360 view: Contains the normal camera view next to a 360 degree camera view.



Normal view: Provides an image of what is directly in front or behind your vehicle.



Split view: Provides an extended view of what is in front or behind your vehicle.



Zooms in on the image.

Parking Aids

Keep Out Zone

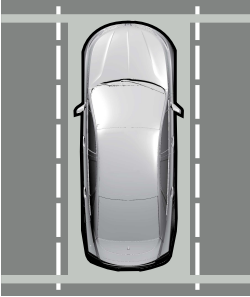

E225016

The yellow dotted lines running parallel to your vehicle represent the keep out zone.

Front Camera



WARNING: The front camera system still requires the driver to use it in conjunction with looking out of your vehicle.

Note: *The system turns off the front video image when your vehicle is in motion at low speeds, except when in reverse (R).*

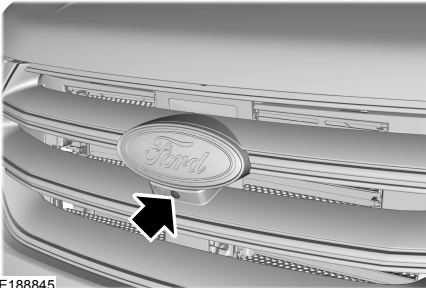

E188845

The front video camera is on the grille and provides a video image of the area in front of your vehicle. To use the front video camera system, place the transmission in any gear except reverse (R). An image displays once you press the front camera enable button. The image on the screen may vary according to your vehicle's orientation or road condition.

Side Camera

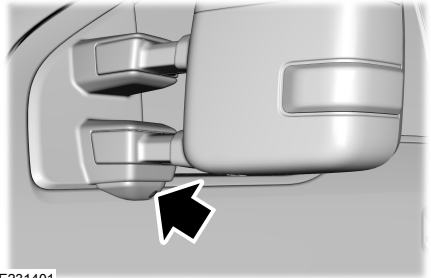

E231401

The side view camera, in the outside mirror, provides a video image of the area on the sides of your vehicle as part of the front 360 + normal view and rear 360 + normal view. It aids you while parking your vehicle either forward or backward.

Cruise Control

WHAT IS CRUISE CONTROL

Cruise control lets you maintain a set speed without keeping your foot on the accelerator pedal.

Requirements

Use cruise control when the vehicle speed is greater than 20 mph (30 km/h).

SWITCHING CRUISE CONTROL ON AND OFF



WARNING: Do not use cruise control on winding roads, in heavy traffic or when the road surface is slippery. This could result in loss of vehicle control, serious injury or death.

The cruise controls are on the steering wheel.

Switching Cruise Control On



Press the button to put the system in standby mode.

Switching Cruise Control Off



Press the button when in standby mode or switch the ignition off.

Note: When you switch cruise control off the set speed clears.

SETTING THE CRUISE CONTROL SPEED



WARNING: When you are going downhill, your vehicle speed could increase above the set speed. The system does not apply the brakes.

Drive to the speed you prefer.

SET+

Press the toggle button upward or downward to set the current speed.

SET-

Take your foot off the accelerator pedal.

Note: The indicator changes color in the information display.

Changing the Set Speed

SET+

Press and release the toggle button upward to increase the set speed in small increments.

Press and hold the toggle button upward to accelerate. Release the button when you have reached your preferred speed.

SET-

Press and release the toggle button downward to decrease the set speed in small increments.

Press and hold the toggle button downward to decelerate. Release the button when you have reached your preferred speed.

Note: If you accelerate by pressing the accelerator pedal, the set speed does not change. When you release the accelerator pedal, your vehicle returns to the speed that you previously set.

Cruise Control

CANCELING THE SET SPEED



Press the button, or tap the brake pedal to cancel the set speed.

Note: *The system remembers the set speed.*

Note: *The system cancels if the vehicle speed drops below 10 mph (16 km/h) under the set speed when driving uphill.*

RESUMING THE SET SPEED



Press the button.

CRUISE CONTROL INDICATORS



Illuminates when you switch the system on.

Adaptive Cruise Control (If Equipped)

HOW DOES ADAPTIVE CRUISE CONTROL WITH STOP AND GO WORK

Adaptive cruise control with stop and go uses radar and camera sensors to adjust the speed of your vehicle to maintain a set gap from the vehicle in front of you in the same lane while following it to a complete stop. You can also engage the system to follow a vehicle in front of you and adjust set speed while stopped.

WHAT IS ADAPTIVE CRUISE CONTROL WITH LANE CENTERING

Adaptive cruise control with lane centering uses radar and camera sensors to help keep your vehicle in the lane by applying continuous assistance steering torque input toward the lane center on highways.

Note: *The adaptive cruise control gap setting operates normally.*

WHAT IS INTELLIGENT ADAPTIVE CRUISE CONTROL

Intelligent adaptive cruise control combines speed sign recognition with adaptive cruise control to adjust the cruise set speed to the speed limit detected by the speed sign recognition system. For example, if the speed sign recognition system detects a 50 mph (80 km/h) speed limit, the cruise set speed is updated to 50 mph (80 km/h) +/- the driver's selected speed offset.

Note: *The adaptive cruise control gap setting operates normally.*

ADAPTIVE CRUISE CONTROL PRECAUTIONS - VEHICLES WITH: LANE CENTERING

Adaptive cruise control precautions apply to lane centering unless stated otherwise or contradicted by a lane centering precaution. See **Adaptive Cruise Control Precautions** (page 241).



WARNING: Do not use the system when towing a trailer. Failure to follow this instruction could result in the loss of control of your vehicle, personal injury or death.



WARNING: Do not use the system if any changes or modifications to the steering wheel have been made. Any changes or modifications to the steering wheel could affect the functionality or performance of the system. Failure to follow this instruction could result in the loss of control of your vehicle, personal injury or death.

ADAPTIVE CRUISE CONTROL PRECAUTIONS - VEHICLES WITH: STOP AND GO



WARNING: You are responsible for controlling your vehicle at all times. The system is designed to be an aid and does not relieve you of your responsibility to drive with due care and attention. Failure to follow this instruction could result in the loss of control of your vehicle, personal injury or death.

Adaptive Cruise Control (If Equipped)

 **WARNING:** Pay close attention to changing road conditions such as entering or leaving a highway, on roads with intersections or roundabouts, roads without visible lanes of travel, roads that are winding, slippery, unpaved, or steep slopes.

 **WARNING:** The system does not control speed in low traction conditions or extremely steep slopes. The system is designed to be an aid and does not relieve you of your responsibility to drive with due care and attention. Failure to follow this instruction could result in personal injury.

 **WARNING:** The system is not a crash warning or avoidance system.

 **WARNING:** Do not use the system when towing a trailer that has aftermarket electronic trailer brake controls. Failure to follow this instruction could result in the loss of control of your vehicle, personal injury or death.

 **WARNING:** Do not use tire sizes other than those recommended because this can affect the normal operation of the system. Failure to do so may result in a loss of vehicle control, which could result in serious injury.

 **WARNING:** Do not use the system with a snow plow blade installed.

 **WARNING:** Do not use the system in poor visibility, for example fog, heavy rain, spray or snow.

When Following a Vehicle

 **WARNING:** When following a vehicle that is braking, your vehicle does not always decelerate quickly enough to avoid a crash without driver intervention. Apply the brakes when necessary. Failure to follow this instruction could result in personal injury or death.

Hilly Condition Usage

You should select a lower gear when the system is active in situations such as prolonged downhill driving on steep grades, for example in mountainous areas. The system needs additional engine braking in these situations to reduce the load on the vehicle's regular brake system to prevent it from overheating.

Note: *An audible alarm sounds and the system shuts down if it applies brakes for an extended period of time. This allows the brakes to cool. The system functions normally again after the brakes cool.*

ADAPTIVE CRUISE CONTROL LIMITATIONS - VEHICLES WITH: LANE CENTERING

Adaptive cruise control limitations apply to lane centering unless stated otherwise or contradicted by a lane centering limitation. See **Adaptive Cruise Control Limitations** (page 243).

The system may not correctly operate in any of the following conditions:

- The lane is too narrow or wide.
- The system does not detect at least one lane marking or when lanes merge or split.
- Limited steering torque input is applied.

Adaptive Cruise Control (If Equipped)

- Areas under construction or new infrastructure.
- When modifications to the steering system have been made.
- When using a spare tire.

Note: *The driving assistance torque is limited and may not be sufficient for all driving situations such as driving through tight curves or driving through curves at high speeds.*

Note: *In exceptional conditions, the system may deviate from the center line.*

ADAPTIVE CRUISE CONTROL LIMITATIONS - VEHICLES WITH: STOP AND GO

Sensor Limitations

WARNING: On rare occasions, detection issues can occur due to the road infrastructures, for example bridges, tunnels and safety barriers. In these cases, the system may brake late or unexpectedly. At all times, you are responsible for controlling your vehicle, supervising the system and intervening, if required.

WARNING: If the system malfunctions, have your vehicle checked as soon as possible.

WARNING: Large contrasts in outside lighting can limit sensor performance.

WARNING: The system only warns of vehicles detected by the radar sensor. In some cases there may be no warning or a delayed warning. Apply the brakes when necessary. Failure to follow this instruction could result in personal injury or death.

WARNING: The system may not detect stationary or slow moving vehicles below 6 mph (10 km/h).

WARNING: The system does not detect pedestrians or objects in the road.

WARNING: The system does not detect oncoming vehicles in the same lane.

WARNING: The system may not operate properly if the sensor is blocked. Keep the windshield free from obstruction.

WARNING: The sensor may incorrectly track lane markings as other structures or objects. This can result in a false or missed warning.



The camera is mounted on the windshield behind the interior mirror.

Adaptive Cruise Control (If Equipped)

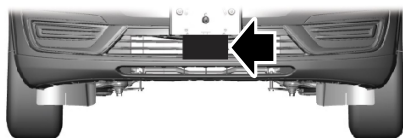

The radar sensor is in the lower grille.

Note: You cannot see the sensor. It is behind a fascia panel.

Note: Keep the front of your vehicle free of dirt, metal badges or objects. Vehicle front protectors, aftermarket lights, additional paint or plastic coatings could also degrade sensor performance.

A message displays if something obstructs the camera or the sensor. When something blocks the sensor, the system cannot detect a vehicle ahead and does not function. See **Adaptive Cruise Control – Information Messages** (page 250).

The radar sensor has a limited field of view. It may not detect vehicles at all or detect a vehicle later than expected in some situations. The lead vehicle image does not illuminate if the system does not detect a vehicle in front of you.

Detection issues can occur:

A

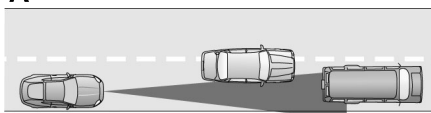

B

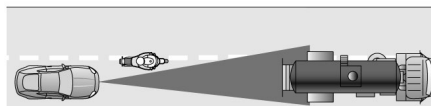

C

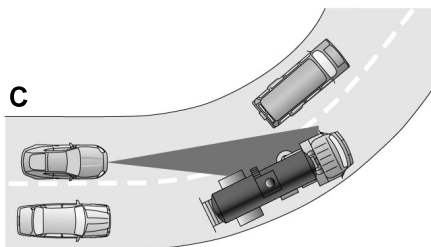

- A When driving on a different line than the vehicle in front.
- B With vehicles that edge into your lane. The system can only detect these vehicles once they move fully into your lane.
- C There may be issues with the detection of vehicles in front when driving into and coming out of a bend or curve in the road.

In these cases, the system may brake late or unexpectedly.

If something hits the front end of your vehicle or damage occurs, the radar-sensing zone may change. This could cause missed or false vehicle detection.

Adaptive Cruise Control (if Equipped)

Optimal system performance requires a clear view of the road by the windshield-mounted camera.

Optimal performance may not occur if:

- The camera is blocked.
- There is poor visibility or lighting conditions.
- There are bad weather conditions.

SWITCHING ADAPTIVE CRUISE CONTROL ON AND OFF

The cruise controls are on the steering wheel. See **Cruise Control** (page 82).

Switching Adaptive Cruise Control On



Press the button to set the system in standby mode.

The indicator, current gap setting and set speed appear in the information display.

Switching Adaptive Cruise Control Off



Press the button when the system is in standby mode, or switch the ignition off.

Note: You erase the set speed when you switch the system off.

Automatic Cancellation or Deactivation

The system may cancel if:

- The tires lose traction.
- You apply the parking brake.

The system may cancel and set the parking brake if:

- You unbuckle the seatbelt and open the driver door after you stop your vehicle.
- Your vehicle is at a stop continuously for more than three minutes.

The system may turn off or prevent activating when requested if:

- The vehicle has a blocked sensor.
- The brake temperature is too high.
- There is a failure in the system or a related system.

SETTING THE ADAPTIVE CRUISE CONTROL SPEED

Drive to the speed you prefer.



Press the toggle button upward or downward to set the current speed.



Take your foot off the accelerator pedal.

The indicator, current gap setting and set speed appear in the information display.



A vehicle image illuminates if there is a vehicle detected in front of you.

Note: When adaptive cruise control is active, the speedometer may vary slightly from the set speed displayed in the information display.

Adaptive Cruise Control (If Equipped)

Setting the Adaptive Cruise Speed from a Complete Stop

SET+ Press the toggle button upward or downward while keeping the brake pedal fully pressed.

SET-

The set speed adjusts to 20 mph (30 km/h).

The indicator, current gap setting and set speed appear in the information display.

Note: *The system activates from a complete stop only when it detects a lead vehicle in close proximity.*

Manually Changing the Set Speed

SET+ Press and release the toggle button upward to increase the set speed in small increments.

Press and hold the toggle button upward to increase the set speed in large increments. Release the button when the set speed is equal to your desired speed.

SET- Press and release the toggle button downward to decrease the set speed in small increments.

Press and hold the toggle button downward to decrease the set speed in large increments. Release the button when the set speed is equal to your desired speed.

You can also press the accelerator or brake pedal until you reach the speed you prefer. Press the toggle button upward or downward to select the current speed as the set speed.

The system may apply the brakes to slow the vehicle to the new set speed. The set speed continuously displays in the information display when the system is active.

SETTING THE ADAPTIVE CRUISE CONTROL GAP

SET Press the button to cycle through the four gap settings.



The selected gap appears in the instrument cluster display as shown by the bars in the image.

Note: *The gap setting is time dependent and therefore, the distance adjusts with your vehicle speed.*

Note: *It is your responsibility to select a gap appropriate to the driving conditions.*

Adaptive Cruise Control Gap Settings

Graphic Display, Bars Indicated Between Vehicles	Gap Distance	Dynamic Behavior
1	Closest.	Sport.
2	Close.	Normal.
3	Medium.	Normal.
4	Far.	Comfort.

Adaptive Cruise Control (If Equipped)

Each time you switch the system on, it selects the last chosen gap setting.

Following a Vehicle

When a vehicle ahead of you enters the same lane or a slower vehicle is ahead in the same lane, the vehicle speed adjusts to maintain the gap setting.

Note: *When you are following a vehicle and you switch on a turn signal lamp, adaptive cruise control may provide a small, temporary acceleration to help you pass.*

Your vehicle maintains a consistent gap from the vehicle ahead until:

- The vehicle in front of you accelerates to a speed above the set speed.
- The vehicle in front of you moves out of the lane you are in.
- You set a new gap distance.

The system applies the brakes to slow down your vehicle to maintain a safe gap distance from the vehicle in front of you. The system only applies limited braking. You can override the system by applying the brakes.

Note: *The brakes may emit noise when applied by the system.*

If the system determines that its maximum braking level is not sufficient, an audible warning sounds, a message appears in the instrument cluster display and an indicator flashes when the system continues to brake. Take immediate action.

CANCELING THE SET SPEED



Press the button or tap the brake pedal.

The set speed does not erase.

RESUMING THE SET SPEED



Press the button.

Your vehicle speed returns to the previously set speed and gap setting. The set speed displays continuously in the information display when the system is active.

Note: *Only use resume if you are aware of the set speed and intend to return to it.*

Resuming the Set Speed from a Complete Stop

If your vehicle follows a vehicle to a complete stop and remains stationary for less than three seconds, your vehicle accelerates from a stationary position to follow the vehicle ahead.



If your vehicle follows a vehicle to a complete stop and remains stationary for more than three seconds, press and release the button or press the accelerator pedal to follow the vehicle ahead.

OVERRIDING THE SET SPEED

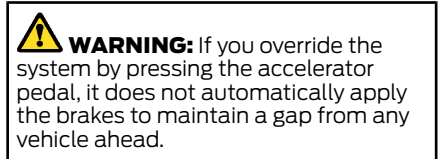

When you press the accelerator pedal, you override the set speed and gap distance.

Use the accelerator pedal to intentionally exceed the set speed limit.

Adaptive Cruise Control (If Equipped)

When you override the system, the green indicator illuminates and the vehicle icon does not appear in the instrument cluster display.

The system resumes operation when you release the accelerator pedal. The vehicle speed decreases to the set speed, or a lower speed if following a slower vehicle.

ADAPTIVE CRUISE CONTROL INDICATORS - VEHICLES WITH: INTELLIGENT ADAPTIVE CRUISE CONTROL

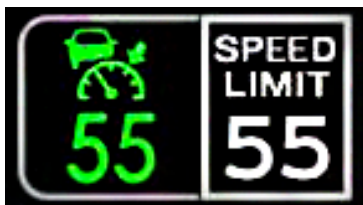

E292490

A bracket appears around the set speed and the detected speed limit sign in the information display.

System Warnings

If the set speed is increased beyond the speed limit or speed limit plus a positive tolerance value, the set speed indicator flashes.

The warning does not occur if:

- You override the set speed using the accelerator pedal.
- The vehicle speed exceeds the set speed due to being on a downhill slope.

ADAPTIVE CRUISE CONTROL INDICATORS - VEHICLES WITH: LANE CENTERING



Illuminates when you switch lane centering on. The color of the indicator changes to indicate the system status.

Gray indicates the system is on but inactive.

Green indicates the system is active and applying assistance steering torque input to keep your vehicle in the center of the lane.

Amber with an audible tone and then gray indicates a system auto-cancellation.

ADAPTIVE CRUISE CONTROL INDICATORS - VEHICLES WITH: STOP AND GO



Illuminates when you switch adaptive cruise control on. The color of the indicator changes to indicate the system status.

White indicates the system is on but inactive.

Green indicates that you set the speed and the system is active.

SWITCHING FROM ADAPTIVE CRUISE CONTROL TO CRUISE CONTROL



WARNING: Normal cruise control will not brake when your vehicle is approaching slower vehicles. Always be aware of which mode you have selected and apply the brakes when necessary.

Adaptive Cruise Control (If Equipped)

Use the touchscreen to select the following:

1. Select **Settings**.
2. Select **Driver Assist**.
3. Select **Cruise Control**.
4. Select **Normal**.



The cruise control indicator replaces the adaptive cruise control indicator if you select normal cruise control. The gap setting does not display, and the system does not respond to lead vehicles. Automatic braking remains active to maintain set speed. The system remembers the last setting when you start your vehicle.

SWITCHING LANE CENTERING ON AND OFF

The cruise controls are on the steering wheel. See **Cruise Control** (page 81).



Press the button.

The indicator appears in the information display. When the system is on, the color of the indicator changes to indicate the system status. See **Adaptive Cruise Control Indicators** (page 248).

Note: *Adaptive cruise control must be on before you can switch lane centering on.*

Activating Lane Centering

The system only activates when all of the following occur:

- You have adaptive cruise control with stop-and-go on.
- Your hands are on the steering wheel.
- The system detects both lane markings.

Note: *If it does not detect valid lane markings, the system stays inactive until valid markings are available.*

You can override the system at any time by steering your vehicle.

System Alerts and Automatic Cancellation

You must keep your hands on the steering wheel at all times.

When the system is active and detects no steering activity for a certain period of time, the system alerts you to put your hands on the steering wheel. If you do not react to the warnings the system cancels and slows your vehicle down to idle speeds while maintaining steering control.

The system also alerts you if your vehicle crosses lane markings without detected steering activity.

Note: *The system may detect a light grip or touch on the steering wheel as hands-off driving.*

When an external condition cancels the system, for example, no lane markings available, a tone sounds and a message appears in the information display.

RES If your vehicle starts to slow down, you must provide steering input to the wheel and press and release the button to regain full system performance.

Automatic cancellation can also occur if:

- The lane becomes too wide or too narrow.
- The system cannot detect valid lane markings.
- Lane markings are crossed.

Note: *The system disables until the next key cycle if your vehicle slows down due to driver inactivity twice within a key cycle.*

Adaptive Cruise Control (If Equipped)

SWITCHING INTELLIGENT MODE ON AND OFF



WARNING: You are responsible for controlling your vehicle at all times. The system is designed to be an aid and does not relieve you of your responsibility to drive with due care and attention. Failure to follow this instruction could result in the loss of control of your vehicle, personal injury or death.

1. Press **Settings** on the touchscreen.
2. Press **Driver Assistance**.
3. Press **Cruise Control**.
4. Press **Intelligent**.

Changing the Set Speed with Intelligent Adaptive Cruise Control

When intelligent mode is on, the system adjusts the set speed to the speed limit detected by the camera and the speed limit information provided by the navigation system.

Note: *The set speed adjusts when the system detects a different maximum speed limit.*

Note: *The speed limit information provided by the navigation map data may be inaccurate or out of date. See **Navigation** (page 449).*

Note: *The system alerts you if the set speed increases beyond the speed limit. See **Adaptive Cruise Control Indicators** (page 248).*

If the system does not detect a speed limit, the vehicle speed remains at the current set speed.

You can override the set speed at any time. You may need to override or cancel the system in certain situations such as inclement weather or if an incorrect speed is set.

Note: *The system may not detect and read speed limit signs with conditional information, for example, when a sign is flashing, during specific time ranges, or when children are present.*

Note: *Under certain conditions, the system may not adjust the vehicle speed until after your vehicle passes the speed limit sign.*

ADJUSTING THE SET SPEED TOLERANCE

You can set a permanent speed tolerance that is above or below the detected speed limit.

1. Press **Settings** on the touchscreen.
2. Press **Driver Assistance**.
3. Press **Cruise Control**.
4. Press **Intelligent**.
5. Press **Tolerance**.
6. Use **+** and **-** to set the tolerance.

Note: *You cannot set the tolerance more than 20 mph (30 km/h) above or below the recognized speed.*

ADAPTIVE CRUISE CONTROL – TROUBLESHOOTING

ADAPTIVE CRUISE CONTROL – INFORMATION MESSAGES - VEHICLES WITH: LANE CENTERING

Note: *Depending on your vehicle options and instrument cluster type, not all messages display or are available.*

Adaptive Cruise Control (If Equipped)

Note: *The system could abbreviate or shorten certain messages depending upon which cluster type you have.*

Message	Action
Keep Hands on Steering Wheel	Return your hands to the steering wheel and provide steering input to cancel the message.
Lane Centering Assist Not Available	To reset the feature when the vehicle is stationary, return the gear selector to park and turn the vehicle off. Restart the vehicle with your foot on the brake pedal.
Resume Control	You must immediately take full control of the vehicle.
Press Accelerator Pedal to Resume	Resume adaptive cruise control with lane centering by applying foot pressure on the accelerator pedal. You can also resume the feature by pressing the resume button on the steering wheel.

Adaptive Cruise Control (If Equipped)

ADAPTIVE CRUISE CONTROL – INFORMATION MESSAGES - VEHICLES WITH: INTELLIGENT ADAPTIVE CRUISE CONTROL

Note: Depending on your vehicle options and instrument cluster type, not all messages display or are available.

Note: Certain messages may be abbreviated or shortened depending upon which cluster type you have.

Message	Action
Intelligent Cruise Control Speed Sign Recognition Not Available	Conditions exist preventing the system from being available.

Adaptive Cruise Control (If Equipped)

ADAPTIVE CRUISE CONTROL – INFORMATION MESSAGES - VEHICLES WITH: STOP AND GO

Note: Depending on your vehicle options and instrument cluster type, not all messages display or are available.

Note: The system could abbreviate or shorten certain messages depending upon which cluster type you have.

Message	Action
Adaptive Cruise Malfunction	A malfunction is preventing the adaptive cruise from engaging.
Front Sensor Not Aligned	Contact an authorized dealer to have the radar checked for proper coverage and operation.
Adaptive Cruise Not Available	Conditions exist preventing the system from being available.
Adaptive Cruise Not Available Sensor Blocked See Manual	You have a blocked radar because of poor radar visibility due to inclement weather or ice, mud, or water in front of the radar. You can typically clean the sensor to resolve this. Due to the nature of radar technology, it is possible to get a blockage warning with no actual block. This happens, for example, when driving in sparse rural or desert environments. A false blocked condition either self clears, or clears after you restart your vehicle.
Normal Cruise Active Adaptive Braking Off	You have selected normal cruise control. The system does not brake or react to traffic.
Adaptive Cruise - Driver Resume Control	Displays when the adaptive cruise control is going to cancel and you must take control.
Adaptive Cruise Speed Too Low to Activate	Displays when the vehicle speed is too slow to activate the adaptive cruise control and there is no lead vehicle in range.

Driving Aids

DRIVER ALERT

PRINCIPLE OF OPERATION

WARNING: You are responsible for controlling your vehicle at all times. The system is designed to be an aid and does not relieve you of your responsibility to drive with due care and attention. Failure to follow this instruction could result in the loss of control of your vehicle, personal injury or death.

WARNING: The system may not function if the sensor is blocked.

WARNING: Take regular rest breaks if you feel tired. Do not wait for the system to warn you.

WARNING: Certain driving styles may result in the system warning you even if you are not feeling tired.

WARNING: In cold and severe weather conditions the system may not function. Rain, snow and spray can all limit sensor performance.

WARNING: The system will not operate if the sensor cannot track the road lane markings.

WARNING: If damage occurs in the immediate area surrounding the sensor, have your vehicle checked as soon as possible.

WARNING: The system may not correctly operate if your vehicle is fitted with a suspension kit not approved by us.

Note: Keep the windshield free from obstructions. For example, bird droppings, insects and snow or ice.

Note: If the camera is blocked or if the windshield is damaged, the system may not function.

Note: The system remembers the on or off setting in the information display menu through ignition cycles.

Note: If enabled in the menu, the system activates at speeds above 40 mph (64 km/h). When below the activation speed, the information display informs the driver that the system is unavailable.

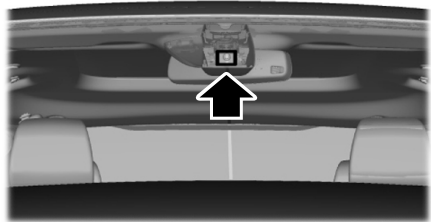

E249505

The system automatically monitors your driving behavior using various inputs including the front camera sensor.

If the system detects that your driving alertness is reduced below a certain threshold, the system alerts you using a chime and a message in the cluster display.

USING DRIVER ALERT

Switching the System On and Off

Switch the system on or off using the touchscreen. See **Settings** (page 458).

When active, the system monitors your alertness level based upon your driving behavior in relation to the lane markings, and other factors.

System Warnings

Note: The system does not issue warnings below approximately 40 mph (64 km/h).

Driving Aids

Note: If you receive a warning you should consider resting, even if the current assessment is within the typical range.

The warning system has two stages. At first, the system issues a temporary warning that you need to take a rest. This message only appears for a short time. If the system detects further reduction in driving alertness, it may issue another warning that remains in the information display for a longer time. You can press OK on the steering wheel control to clear the warning.

Resetting the System

You can reset the system by either:

- Switching the ignition off and on.
- Stopping the vehicle and then opening and closing the driver's door.

LANE KEEPING SYSTEM

 **WARNING:** You are responsible for controlling your vehicle at all times. The system is designed to be an aid and does not relieve you of your responsibility to drive with due care and attention. Failure to follow this instruction could result in the loss of control of your vehicle, personal injury or death.

 **WARNING:** Always drive with due care and attention when using and operating the controls and features on your vehicle.

 **WARNING:** In cold and severe weather conditions the system may not function. Rain, snow and spray can all limit sensor performance.

 **WARNING:** Large contrasts in outside lighting can limit sensor performance.

 **WARNING:** The system will not operate if the sensor cannot track the road lane markings.

 **WARNING:** The sensor may incorrectly track lane markings as other structures or objects. This can result in a false or missed warning.

 **WARNING:** The system may not operate properly if the sensor is blocked. Keep the windshield free from obstruction.

 **WARNING:** If damage occurs in the immediate area surrounding the sensor, have your vehicle checked as soon as possible.

 **WARNING:** The system may not correctly operate if your vehicle is fitted with a suspension kit not approved by us.

Note: The system works above 40 mph (64 km/h).

Note: The system works as long as the camera can detect one lane marking.

Note: When you select aid or alert and aid mode and the system detects no steering activity for a short period, the system alerts you to put your hands on the steering wheel. **The system may detect a light grip or touch on the steering wheel as hands off driving.**

Note: The system may not function if the camera is blocked, or if the windshield is damaged or dirty.

Driving Aids

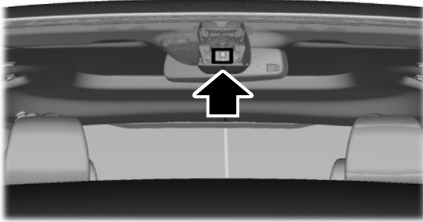

E249505

When you switch the system on and it detects an unintentional drift out of your lane is likely to occur, the system notifies or assists you to stay in your lane through the steering system and information display. In Alert mode (if equipped), the system provides a warning by vibrating the steering wheel. In Aid mode, the system provides steering assistance by gently counter steering your vehicle back into the lane.

When the system is functioning in the combined Alert and Aid mode, the system first provides steering assistance by gently counter steering your vehicle back into the lane, followed by a warning that vibrates the steering wheel if the vehicle is still out of the lane markings.

Switching the System On and Off

Note: *The system is turned on automatically at each ignition cycle.*



Press the button on the direction indicator stalk to switch the system on or off.

System Settings

The system has optional setting menus available. The system stores the last known selection for each of these settings. You do not need to readjust your settings each time you switch the system on.

Mode: This setting allows you to select which of the system features you can enable.

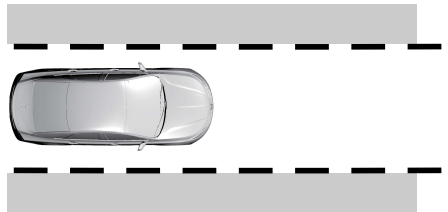

Alert only (if equipped) – Provides a steering wheel vibration when the system detects an unintended lane departure.

Driving Aids

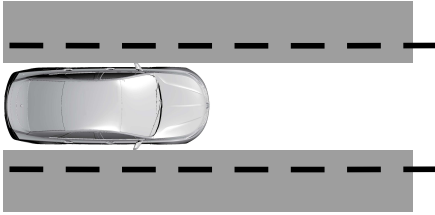

Aid only – Provides steering assistance toward the lane center when the system detects an unintended lane departure.

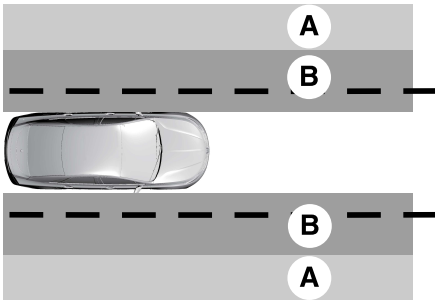

- A Alert
- B Aid

Alert + Aid – Provides steering assistance toward the lane center.

If your vehicle continues drifting out of the lane after the lane keeping aid corrects the vehicle, the system provides a steering wheel vibration.

If your vehicle stays to one side of the lane after the lane keeping aid corrects your vehicle and then subsequently drifts out of the lane again, the system only provides an alert at the steering wheel.

Note: The alert and aid diagrams illustrate general zone coverage. They do not provide exact zone parameters.

Intensity: This setting affects the intensity of the steering wheel vibration used for the alert (if equipped) and alert + aid modes. **This setting does not affect the aid mode.**

- Low.
- Normal.
- High.

System Display

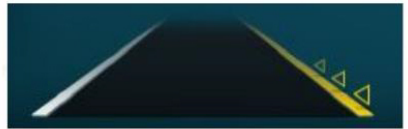

When you switch the system on, a graphic of lane markings appears in the information display.

When you switch the system off, the lane marking graphics do not display.

While the system is on, the color of the lane markings change to indicate the system status. These colors represent the following:

Gray: Indicates that the system is temporarily unable to provide a warning or intervention on the indicated side. This may be because:

Driving Aids

- Your vehicle is under the activation speed.
- The direction indicator is active.
- Your vehicle is in a dynamic maneuver.
- The road has no or poor lane markings in the camera field-of-view.
- The camera is obscured or unable to detect the lane markings due to environmental, traffic or vehicle conditions. For example, significant sun angles, shadows, snow, heavy rain or fog, following a large vehicle that is blocking or shadowing the lane or poor headlamp illumination.

See **Troubleshooting** for additional information.

White: Indicates that the system is available or ready to provide a warning or intervention on the indicated side.

Troubleshooting

Why is the feature not available (line markings are gray) when I can see the lane markings on the road?
Your vehicle speed is outside the operational range of the feature.
The sun is shining directly into the camera lens.
A quick intentional lane change has occurred.
Your vehicle stays too close to the lane markings.
Driving at high speeds in curves.
The last alert warning or aid intervention occurred a short time ago.
Ambiguous lane markings, for example in construction zones.
Rapid transition from light to dark, or from dark to light.
Sudden offset in lane markings.
ABS or AdvanceTrac™ is active.
There is a camera blockage due to dirt, grime, fog, frost or water on the windshield.
You are driving too close to the vehicle in front of you.

Note: *If your vehicle has lane centering assist and the system is active, the walls appear green instead of white.*

Yellow: Indicates that the system is providing or has just provided a lane keeping aid intervention.

Red: Indicates that the system is providing or has just provided a lane keeping alert warning.

The system can be temporarily suppressed at any time by the following:

- Quick braking.
- Fast acceleration.
- Using the direction indicator.
- Evasive steering maneuver.
- Driving too close to the lane markings.

Driving Aids

Why is the feature not available (line markings are gray) when I can see the lane markings on the road?

Transitioning between no lane markings to lane markings or vice versa.

There is standing water on the road.

Faint lane markings, for example partial yellow lane markings on concrete roads.

Lane width is too narrow or too wide.

The camera has not been calibrated after a windshield replacement.

Driving on tight roads or on uneven roads.

Why does the vehicle not come back toward the middle of the lane, as expected, in the Aid or Aid + Alert mode?

High cross winds are present.

There is a large road crown.

Rough roads, grooves or shoulder drop-offs.

Heavy uneven loading of the vehicle or improper tire inflation pressure.

The tires have been changed, or the suspension has been modified.

BLIND SPOT INFORMATION SYSTEM



WARNING: Do not use the blind spot information system as a replacement for using the interior and exterior mirrors or looking over your shoulder before changing lanes. The blind spot information system is not a replacement for careful driving.



WARNING: The system may not operate properly during severe weather conditions, for example snow, ice, heavy rain and spray. Always drive with due care and attention. Failure to take care may result in a crash.

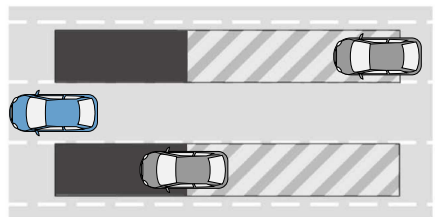

Driving Aids

The design of the system is to detect vehicles that enter the blind spot zone. The detection area is on both sides of your vehicle, extending rearward from the exterior mirrors to approximately 13 ft (4 m) beyond the rear bumper. The detection area extends to approximately 59 ft (18 m) beyond the rear bumper when the vehicle speed is greater than 30 mph (48 km/h) to alert you of faster approaching vehicles.

Note: *The system does not prevent contact with other vehicles. It does not detect parked vehicles, pedestrians, animals or other infrastructures.*

Using the Blind Spot Information System

Vehicles with Automatic Transmission

The system turns on when all of the following occur:

- You start your vehicle.
- You shift into drive (D).
- The vehicle speed is greater than 6 mph (10 km/h).

Note: *The system does not operate in park (P) or reverse (R).*

System Lights and Messages



When the system detects a vehicle, an alert indicator illuminates in the exterior mirror on the side the approaching vehicle is coming from. If you switch the direction indicator on for that side of your vehicle, the alert indicator flashes.

Note: *The system may not alert you if a vehicle quickly passes through the detection zone.*

Blocked Sensors

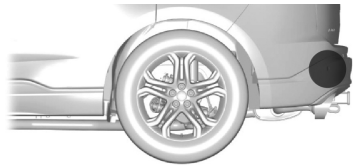

The sensors are behind the rear bumper on both sides of your vehicle.

Note: *Keep the sensors free from snow, ice and large accumulations of dirt.*

Note: *Do not cover the sensors with bumper stickers, repair compound or other objects.*

Note: *Blocked sensors could affect system performance.*

Note: *Bike and cargo racks could cause false alerts due to obstruction of the sensor. We recommend switching the feature off when using a bike or cargo rack.*

If the sensors become blocked, a message could appear in the information display. See **Information Messages** (page 119). The alert indicators remain illuminated, but the system does not alert you.

System Errors

If the system detects a fault, a warning lamp illuminates and a message displays. See **Information Messages** (page 119).

Driving Aids

Switching the System On and Off

To switch the system on or off, adjust the setting. Depending on your vehicle options, the setting could be in the following:

- Information display. See **General Information** (page 115).
- Touchscreen. See **Settings** (page 458).

When you switch the system off, a warning lamp illuminates and the alert indicators flash twice.

Note: *The system remembers the last setting when you start your vehicle.*

To permanently switch the system off, contact an authorized dealer.

Blind Spot Information System with Trailer Tow (If Equipped)

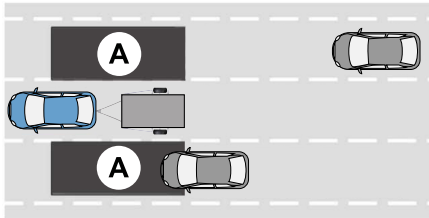

E293525

The design of the system is to aid you in detecting vehicles that could enter the detection area zone (A). The detection area is on both sides of your vehicle and trailer, extending rearward from the exterior mirrors to the end of your trailer. When you attach and have setup a trailer, the blind spot information system with trailer tow becomes active when driving forward above 6 mph (10 km/h).

You can switch the system off in the information display. See **General Information** (page 115). If you switch the blind spot information system off, blind spot information system with trailer tow turns off.

Setting up a Trailer

You can setup a trailer through the information display. See **General Information** (page 115).

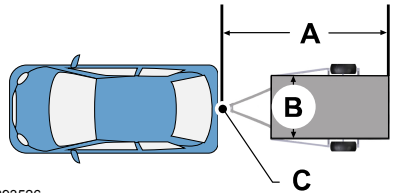

E293526

- A Trailer length.
- B Trailer width.
- C Trailer hitch ball.

Note: *Measure the width of the trailer at the front of the trailer, not the widest point. The maximum width that the system can support is 8.2 ft (2.5 m) (B).*

Note: *The trailer length is the distance between the trailer hitch ball and the rear of the trailer. The maximum length that the system can support is 33 ft (10 m) (A).*

When setting up a trailer, a sequence of screens appear asking for trailer information:

- Select trailer screen: None, Trailer A, Trailer B or Trailer C.

Note: *You can select only one trailer on small information displays.*

Select one of the trailers and press OK. The menu goes to the next screen.

- Width less than 8.2 ft (2.5 m) and length less than 33 ft (10 m)?

Driving Aids

Note: *You do not need to enter an exact trailer width measurement. You only need to confirm that the width of the trailer is 8.2 ft (2.5 m) or less.*

If no, the system turns off.

If yes, the menu goes to the next screen.

- Enter length of trailer:

Toggling up or down using the menu buttons increases or decreases the measurement by 1 ft (0.3 m). Select a length that is equal to or within 1 ft (0.3 m) of the actual measured length. For example, if the actual measured length is 25 ft (7.6 m), toggle the length in the menu to 25 ft (8 m). When you enter the length of the trailer, this saves the system setup.

Note: *When you connect a trailer, but do not setup a trailer in the blind spot information system, the system turns off and a warning appears in the information display.*

Note: *If the trailer is a bike rack or cargo rack with electrical lighting, enter a length of 3 ft (1 m). Cross Traffic Alert remains on for trailers with a length of 3 ft (1 m) or less.*

Note: *The system requires proper measurement and measurement entry to function as designed.*

System Operation

If you select a trailer in the information display prior to connecting a trailer, the system loads that configuration and the information display shows a message when you connect the trailer. A second message appears stating cross traffic alert is off, unless a trailer is set up with a length of 3 ft (1 m). The blind spot information system with trailer tow still functions normally when driving forward.

If you connect a trailer, a message appears indicating that you attached a trailer. If you have not selected a trailer previously, another message appears requesting you to select one of the trailers in the list or add a new trailer. The blind spot information system with trailer tow does not function without a trailer selected. If you do not select a trailer, a message appears in the information display stating the system has turned this feature off. This message might not appear until your vehicle speed reaches 22 mph (35 km/h).

The blind spot information system with trailer tow activates when driving forward for that particular trailer set up. If you cycle the ignition, the blind spot information system with trailer tow continues to function using the last trailer you selected.

Trailer Considerations

The system works with a trailer with a front width of 8.2 ft (2.5 m) or less, and a total length from the trailer hitch ball to the rear of the trailer of 33 ft (10 m) or less.

Some trailers could cause a slight change in system performance:

- Wide box trailers, especially those wider than the towing vehicle, could cause false alerts to occur when driving next to infrastructure or near parked cars. A false alert could also occur while making a 90-degree turn or driving through a roundabout.
- Wide trailers that have a total length greater than 20 ft (6 m) could cause delayed alerts when a vehicle is passing at high speeds.

Driving Aids

- Box trailers that have a width greater than 8.2 ft (2.5 m) could cause early alerts when you pass a vehicle.
- Clam shell or V-Nose box trailers with a width greater than 8.2 ft (2.5 m) could cause delayed alerts when a vehicle traveling the same speed as your vehicle merges lanes.

System Errors

If the system detects a fault, a warning lamp illuminates and a message displays. See **Information Messages** (page 119).

Switching the System On and Off

You can switch the blind spot information system with trailer tow off by not selecting a trailer in the information display. See **General Information** (page 115). In this case, the system turns off as long as a trailer is attached to your vehicle. As soon as you disconnect the trailer, the blind spot information system becomes active.

When you switch the system off, a warning lamp illuminates and the alert indicators flash twice.

Note: *The system remembers the last trailer setting when you start your vehicle.*

You cannot switch off the blind spot information system with trailer tow when using MyKey, but you can still change the trailer settings. See **MyKey™** (page 64).

To permanently switch the system off, contact an authorized dealer.

CROSS TRAFFIC ALERT



WARNING: Do not use the cross traffic alert system as a replacement for using the interior and exterior mirrors or looking over your shoulder before reversing out of a parking space. The cross traffic alert system is not a replacement for careful driving.



WARNING: The system may not operate properly during severe weather conditions, for example snow, ice, heavy rain and spray. Always drive with due care and attention. Failure to take care may result in a crash.

The system alerts you of vehicles approaching from the sides behind your vehicle when you shift into reverse (R).

Using Cross Traffic Alert

The system detects vehicles that approach at a speed between 4 mph (6 km/h) and 37 mph (60 km/h). Coverage decreases when the sensors are partially, mostly or fully obstructed. Slowly reversing helps increase the coverage area and effectiveness.

The system turns on when you start the engine and you shift into reverse (R). The system turns off when you shift out of reverse (R).

Driving Aids

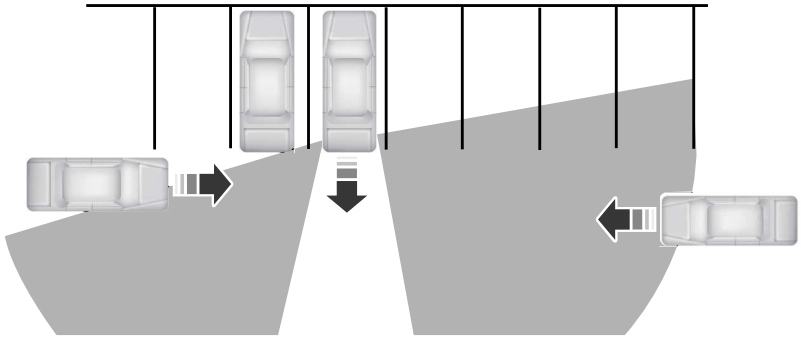

The sensor on the left-hand side is only partially obstructed and zone coverage on the right-hand side is maximized.

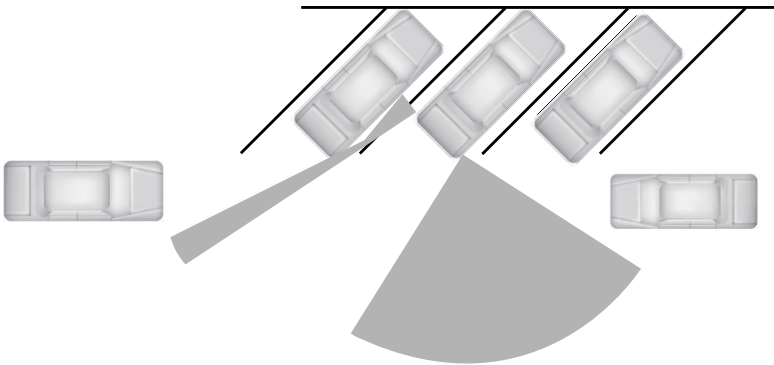

Driving Aids

Zone coverage also decreases when parking at narrow angles. The sensor on the left-hand side is mostly obstructed and zone coverage on that side is severely reduced.

Cross Traffic Alert System Sensors

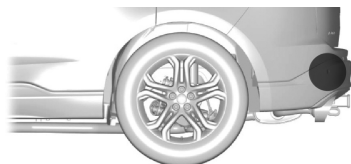

The sensors are behind the rear bumper on both sides of your vehicle.

Note: Keep the sensors free from snow, ice and large accumulations of dirt.

Note: Do not cover the sensors with bumper stickers, repair compound or other objects.

Note: Blocked sensors could affect system performance.

Note: Bike and cargo racks could cause false alerts due to obstruction of the sensor. We recommend switching the feature off when using a bike or cargo rack.

If the sensors are blocked, a message may appear in the information display when you shift into reverse (R).

Cross Traffic Alert System Limitations

The system may not correctly operate when any of the following occur:

- The sensors are blocked.
- Adjacently parked vehicles or objects are obstructing the sensors.
- Vehicles approach at speeds less than 4 mph (6 km/h) or greater than 37 mph (60 km/h).

- The vehicle speed is greater than 7 mph (12 km/h).
- You reverse out of an angled parking space.

Cross Traffic Alert Behavior When Trailer is Attached

Note: The system may not correctly operate when towing a trailer. For vehicles with an approved trailer tow module and tow bar, the system turns off when you attach a trailer. For vehicles with an aftermarket trailer tow module or tow bar, we recommend that you switch the system off when you attach a trailer.

Cross traffic alert remains on when you attach a trailer in vehicles that come with blind spot information system with trailer tow under the following conditions:

- You connect a trailer.
- The trailer is a bike rack or cargo rack with a maximum length of 3 ft (1 m).
- You set the trailer length to 3 ft (1 m) in the information display.

See **Blind Spot Information System** (page 259).

Switching the System On and Off

To switch the system on or off, adjust the setting. Depending on your vehicle options, the setting could be in the following:

- Information display. See **General Information** (page 110).
- Touchscreen. See **Settings** (page 458).

Note: The system turns on every time you switch the ignition on. To permanently switch the system off, contact an authorized dealer.

Driving Aids

Cross Traffic Alert Indicator



When the system detects an approaching vehicle, a tone sounds, a warning lamp illuminates in the relevant exterior mirror and arrows appear in the information display to show which side the approaching vehicle is coming from.

Note: If arrows do not display, a message appears in the information display.

If the system malfunctions, a warning lamp illuminates in the instrument cluster and a message appears in the information display. Have your vehicle checked as soon as possible.

Note: In exceptional conditions, the system could alert you, even when there is nothing in the detection zone, for example a vehicle passing further away from your vehicle.

Cross Traffic Alert Information Messages

Message	Action
Cross Traffic Alert	Displays instead of indication arrows when the system detects a vehicle. Check for approaching traffic.
Cross Traffic Not Available Sensor Blocked See Manual	Indicates blocked cross traffic alert system sensors. Clean the sensors. If the message continues to appear, have your vehicle checked as soon as possible.
Cross Traffic System Fault	The system has malfunctioned. Have your vehicle checked as soon as possible.
Cross Traffic Alert Deactivated Trailer Attached	Displays if you attach a trailer to your vehicle.

SPEED SIGN RECOGNITION (IF EQUIPPED)

Principle of Operation



WARNING: You are responsible for controlling your vehicle at all times. The system is designed to be an aid and does not relieve you of your responsibility to drive with due care and attention. Failure to follow this instruction could result in the loss of control of your vehicle, personal injury or death.



WARNING: In cold and severe weather conditions the system may not function. Rain, snow and spray can all limit sensor performance.



WARNING: The system may not operate properly if the sensor is blocked. Keep the windshield free from obstruction.

The system is designed to detect speed limit signs to inform you of the current speed limit. Detected speed signs appear in the information display. The sensor is behind the interior mirror.

Note: Do not carry out windshield repairs in the immediate area surrounding the sensor.

Driving Aids

Note: Speed sign data provided by the navigation system contains information integrated to the data carrier release.

Note: The system may not detect or correctly read all speed signs.

Note: If your vehicle has a suspension kit not approved by us, the system may not correctly function.

Note: Always replace headlamp bulbs with those specifically designed for your vehicle. Other bulbs could reduce system performance.

The system turns on when you switch the ignition on, and you cannot switch the system off.

Using Speed Sign Recognition

Setting the System Speed Warning

You can set the system speed warning to alert you when the vehicle speed exceeds the speed limit recognized by the system by a certain speed tolerance.

Note: The system remembers the last setting when you start your vehicle.

Information Messages

Message	Action
Traffic Sign Reduced Performance See Manual	The traffic sign data provided by the navigation system is unavailable due to a weak signal, or no signal. Wait for a short period of time for the signal to improve. If the message continues to appear, have your vehicle checked as soon as possible.

System Display



When the system detects a speed limit sign, the speed limit appears in the information display.

Note: If your vehicle has a navigation system, stored speed sign data could influence the indicated speed limit value.

To switch the system off or to adjust the settings, use the touchscreen:

1. Press **Settings** on the touchscreen.
2. Press **Driver Assistance**.
3. Press **Speed Sign Recognition**.
4. Press **Speed Warning**.
5. Press **Tolerance**.
6. Use **+** and **-** to set the tolerance.

Driving Aids

STEERING

Electric Power Steering



WARNING: The electric power steering system has diagnostic checks that continuously monitor the system. If a fault is detected, a message displays in the information display. Stop your vehicle as soon as it is safe to do so. Switch the ignition off. After at least 10 seconds, switch the ignition on and watch the information display for a steering system warning message. If a steering system warning message returns, have the system checked as soon as possible.



WARNING: If the system detects an error, you may not feel a difference in the steering, however a serious condition may exist. Have your vehicle checked as soon as possible. Failure to do so may result in loss of steering control.

Your vehicle has an electric power steering system, there is no fluid reservoir, no maintenance is required.

If your vehicle loses electrical power while you are driving, electric power steering assistance is lost. The steering system still operates and you can steer your vehicle manually. Manually steering your vehicle requires more effort.

Extreme continuous steering may increase the effort required for you to steer your vehicle, this increased effort prevents overheating and permanent damage to the steering system. You do not lose the ability to steer your vehicle manually. Typical steering and driving maneuvers allow the system to cool and return to normal operation.

Steering Tips

If the steering wanders or pulls, check for:

- Correct tire pressures.
- Uneven tire wear.
- Loose or worn suspension components.
- Loose or worn steering components.
- Improper vehicle alignment.

Note: *A high crown in the road or high crosswinds may also make the steering seem to wander or pull.*

Adaptive Learning (If Equipped)

The electronic power steering system adaptive learning helps correct road irregularities and improves overall handling and steering feel. It communicates with the brake system to help operate advanced stability control and accident avoidance systems. Additionally, whenever the battery is disconnected or a new battery installed, you must drive your vehicle a short distance before the system relearns the strategy and reactivates all systems.

PRE-COLLISION ASSIST



WARNING: You are responsible for controlling your vehicle at all times. The system is designed to be an aid and does not relieve you of your responsibility to drive with due care and attention. Failure to follow this instruction could result in the loss of control of your vehicle, personal injury or death.

Driving Aids



WARNING: The system does not detect vehicles that are driving in a different direction, cyclists or animals. Apply the brakes when necessary. Failure to follow this instruction could result in the loss of control of your vehicle, personal injury or death.



WARNING: The system does not operate during hard acceleration or steering. Failure to take care may lead to a crash or personal injury.



WARNING: Some situations and objects prevent hazard detection. For example low or direct sunlight, inclement weather, unconventional vehicle types, and pedestrians. Apply the brakes when necessary. Failure to follow this instruction could result in the loss of control of your vehicle, personal injury or death.



WARNING: The system may not operate properly during severe weather conditions, for example snow, ice, heavy rain and spray. Always drive with due care and attention. Failure to take care may result in a crash.



WARNING: The system cannot help prevent all crashes. Do not rely on this system to replace driver judgment and the need to maintain a safe distance and speed.

Note: Keep the sensors free from snow, ice and large accumulations of dirt.

Using the Pre-Collision Assist System

The system is active at speeds above approximately 3 mph (5 km/h) and pedestrian detection is active at speeds up to 50 mph (80 km/h).



If your vehicle is rapidly approaching another stationary vehicle, a vehicle traveling in the same direction as yours, or a pedestrian within your driving path, the system design provides three levels of functionality:

1. Alert.
2. Brake Support.
3. Active Braking.

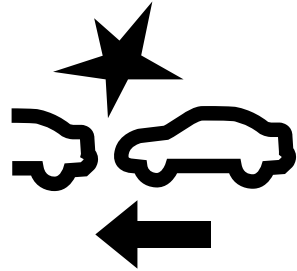

Alert: When active, a flashing visual warning appears and an audible warning tone sounds.

Brake Support: The system design helps reduce the impact speed by preparing the brakes for rapid braking. Brake support does not automatically apply the brakes. If you press the brake pedal, the system could apply additional braking up to maximum braking force, even if you lightly press the brake pedal.

Active Braking: Active braking may activate if the system determines that a collision is imminent. The system may help the driver reduce impact damage or avoid the crash completely.

Driving Aids

Note: Brake support and active braking are active at speeds up to 75 mph (120 km/h). If your vehicle has a radar sensor included with adaptive cruise control, then brake support and active braking are active up to the maximum speed of the vehicle.

Note: If you perceive pre-collision assist alerts as being too frequent or disturbing, then you can reduce the alert sensitivity, though we recommend using the highest sensitivity setting where possible. Setting lower sensitivity would lead to fewer and later system warnings.

Distance Indication and Alert (If Equipped)

Distance indication and alert is a function that provides the driver with a graphical indication of the time gap to other preceding vehicles traveling in the same direction. Distance indication and alert shows one of the graphics that follow in the information display.



If the time gap to a preceding vehicle is small, a red visual indication displays to the driver.

Note: Distance indication and alert deactivates and the graphics do not display when adaptive cruise control is active.

Speed	Sensitivity	Graphics	Distance Gap	Time Gap
62 mph (100 km/h)	Normal	Grey	>82 ft (25 m)	>0.9sec
62 mph (100 km/h)	Normal	Yellow	56–82 ft (17–25 m)	0.6sec — 0.9sec
62 mph (100 km/h)	Normal	Red	<56 ft (17 m)	<0.6sec

Evasive Steering Assist (If Equipped)

If your vehicle is rapidly approaching a stationary vehicle or a vehicle traveling in the same direction as your vehicle, the system design helps you steer around the vehicle.

The system only activates when all of the following occur:

- The system detects a vehicle ahead and starts to apply active braking.
- You turn the steering wheel in an attempt to steer around the vehicle.

Driving Aids

After you turn the steering wheel, the system applies additional steering torque to help you steer around the vehicle. After you pass the vehicle, the system applies steering torque in the opposite direction to encourage you to steer back into the lane. The system deactivates after you fully pass the vehicle.

Note: The system does not automatically steer around a vehicle. If you do not turn the steering wheel, the system does not activate.

Note: The system does not activate if the distance to the vehicle ahead is too small and the system cannot avoid a crash.

Adjusting the Pre-Collision Assist Settings

You can adjust the following settings by using the touchscreen.

- You can change Alert and Distance Alert sensitivity to one of three possible settings.
- You can switch distance indication and alert on or off.
- If required, you can switch active braking on or off.
- If required, you can switch evasive steering assist on or off.

Note: Active braking and evasive steering assist automatically turn on every time you switch the ignition on.

Camera Troubleshooting

Cause	Action
The windshield in front of the camera is dirty or obstructed in some way.	Clean the outside of the windshield in front of the camera.
The windshield in front of the camera is clean but the message remains in the display screen.	Wait a short time. It may take several minutes for the camera to detect that there is no obstruction.

Note: If you switch active braking off, evasive steering assist turns off.

Blocked Sensors

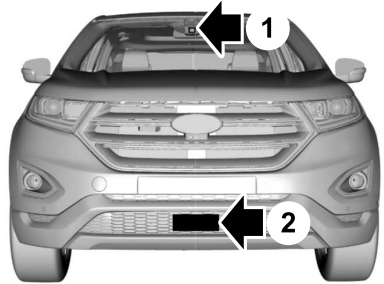

1. Camera.
2. Radar sensor (if equipped).

If a message regarding a blocked sensor or camera appears in the information display, you have obstructed radar signals or camera images. If your vehicle has a radar sensor, it is behind the fascia cover in the center of the lower grille. With a blocked sensor or camera, the system may not function, or performance may reduce. The following table lists possible causes and actions for when this message displays.

Driving Aids

Radar Troubleshooting (If Equipped)

Cause	Action
The surface of the radar in the grille is dirty or obstructed in some way.	Clean the grille surface in front of the radar or remove the object causing the obstruction.
The surface of the radar in the grille is clean but the message remains in the display screen.	Wait a short time. It may take several minutes for the radar to detect that there is no obstruction.
Heavy rain, spray, snow or fog is interfering with the radar signals.	The system is temporarily disabled. The system automatically reactivates a short time after the weather conditions improve.
Swirling water or snow or ice on the surface of the road may interfere with the radar signals.	The pre-collision assist system is temporarily disabled. The system automatically reactivates a short time after the weather conditions improve.
Radar is out of alignment due to a front-end impact.	Have the radar checked for proper coverage and operation.

Note: *Proper system operation requires a clear view of the road by the camera. Have any windshield damage in the area of the camera's field of view repaired.*

Note: *If something hits the front end of your vehicle or damage occurs and your vehicle has a radar sensor, the radar sensing zone may change. This could cause missed or false detections. Contact an authorized dealer to have the radar checked for proper coverage and operation.*

Drive Mode Control

WHAT IS DRIVE MODE CONTROL

Your vehicle has various drive modes that you can select for different driving conditions. Depending on the drive mode that you select, the system adjusts various vehicle settings.

HOW DOES DRIVE MODE CONTROL WORK

Selectable drive modes change various electronic and mechanical settings within your vehicle to tailor its performance and driving characteristics to on-road or off-road driving conditions. Steering feel and effort, traction control, stability control, chassis control, powertrain response, transmission shift points and four-wheel driveline settings alter to a pre-determined setting depending upon the drive mode that you select.

Note: Your vehicle has diagnostic checks that continuously monitor all systems for proper operation. If a drive mode is unavailable due to a system fault, your vehicle defaults to normal mode.

SELECTING A DRIVE MODE

Note: Drive mode changes may not be available when the ignition is off or when the engine is not running.

Note: Button icons shown may vary from your vehicle.



Rotate the drive mode dial on the center console to select or change a drive mode.



To select drive modes for RWD vehicles use the console mounted control.

DRIVE MODES

DEEP SNOW/SAND



For off-road driving on soft dry sand or deep snow. This mode optimizes accelerator pedal response, traction settings, and stability controls to help maintain forward momentum when driving through deep sand or snow. If your vehicle becomes stuck in deep conditions, using this mode may help it become unstuck.

Drive Mode Control

Note: Using deep snow/sand mode on dry, hard surfaces could produce some vibration, driveline bind up, and potential excessive tire wear.

ECO



For efficient driving. This mode helps deliver maximum fuel efficiency and helps to increase driving range.

NORMAL



For everyday driving. This mode is a perfect balance of excitement, comfort and convenience. This is the default mode after each ignition cycle.

SLIPPERY



For less than ideal road conditions such as snow or ice covered roads. This mode lowers throttle response, adjusts transmission shift points, and optimizes vehicle stability controls to help mitigate wheel spin and maintain vehicle control when driving in winter conditions.

Note: Using slippery mode on dry, hard surfaces could produce some vibration, driveline bind up, and potential excessive tire wear.

SPORT



For sporty driving with improved performance handling and response. This mode increases accelerator pedal response, enhances steering to provide a sportier feel, and adjusts transmission shift points for quicker vehicle acceleration.

TOW/HAUL



For improved transmission operation when towing a trailer or a heavy load. This mode moves upshifts to higher engine speeds to reduce the frequency of transmission shifting. This mode also provides engine braking in all forward gears, which slows your vehicle and assists you in controlling your vehicle when descending a slope. The amount of downshift braking provided varies based on the amount you press the brake pedal.

TRAIL



For off-road driving on muddy, rutted, soft, or uneven terrain. This mode lowers throttle response to enhance low speed vehicle control when driving off road. Additionally, the mode optimizes traction and stability control settings, helping the vehicle to maintain forward momentum through loose deformable surfaces.

Load Carrying

GENERAL INFORMATION

WARNING: Make sure that you properly secure objects in the luggage compartment. Failure to follow this instruction could result in personal injury in the event of a sudden stop or crash.

WARNING: Do not place objects on the luggage cover. Failure to follow this instruction could result in personal injury or death in the event of a sudden stop or crash.

WARNING: The appropriate loading capacity of your vehicle can be limited either by volume capacity (how much space is available) or by payload capacity (how much weight the vehicle should carry). Once you have reached the maximum payload of your vehicle, do not add more cargo, even if there is space available. Overloading or improperly loading your vehicle can contribute to loss of vehicle control and vehicle rollover.

WARNING: Make sure that you fully close the liftgate to prevent exhaust fumes from entering your vehicle. If you are unable to fully close the liftgate, open the air vents or the windows to allow fresh air to enter your vehicle. Failure to follow this instruction could result in personal injury or death.

WARNING: Do not exceed the maximum front and rear axle loads for your vehicle.

Note: When loading long objects into your vehicle, for example pipes, timber or furniture be careful not to damage the interior trim.

REAR UNDER FLOOR STORAGE

Spare Tire Cover (If Equipped)



The system is in the floor of the cargo area.

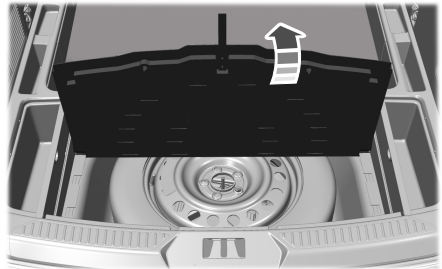

Remove the additional cover to access the spare tire and fuel filler.

Load Carrying

Adjustable Load Floor (If Equipped)

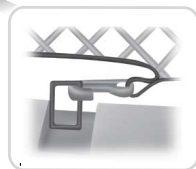
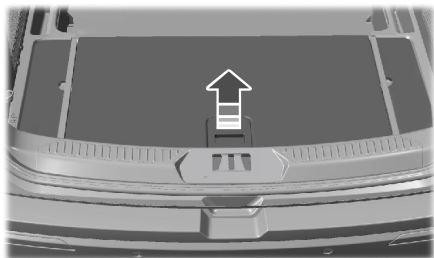

Vehicles with the standard size spare tire can adjust the load floor to two positions. At the high position, you can place the front of the load floor on the ledge behind the rear seat and on the ledge of the liftgate scuff trim. At the low position, you can tuck the front of the load floor into the lower forward area of the spare tire cover and rest the load floor on top of the spare tire cover, or spare tire cover weather mat.

E204323

CARGO NETS



WARNING: This net is not designed to restrain objects during a collision or heavy braking.

The cargo net secures lightweight objects in the cargo area. Attach the net to the anchors provided. Repeat the attachment on both sides of the vehicle.

ROOF RACKS AND LOAD CARRIERS



WARNING: When loading the roof racks, we recommend you evenly distribute the load, as well as maintain a low center of gravity. Loaded vehicles, with higher centers of gravity, may handle differently than unloaded vehicles. Take extra precautions, such as slower speeds and increased stopping distance, when driving a heavily loaded vehicle.

Load Carrying

For correct roof rack system function, you must place loads directly on crossbars affixed to the roof rack side rails. When using the roof rack system, we recommend you use Ford Genuine Accessory crossbars designed specifically for your vehicle.

Make sure that you securely fasten the load. Check the tightness of the load before driving and at each fuel stop.

Note: *Never place loads directly on the roof panel. The roof panel is not designed to directly carry a load.*

Maximum Recommended Load Amounts

Note: *The maximum recommended load is based on the load being evenly distributed on the crossbars.*

Description	Maximum Recommended Load
Vehicles with Moonroof	75 lb (35 kg)
Vehicles without Moonroof	165 lb (75 kg)

Adjusting the Crossbar (If Equipped)

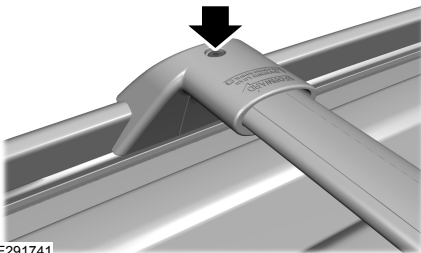

E291741

1. Loosen the crossbar bolt by using the supplied tool or similar tool.
2. Move the crossbar to the new position.
3. Tighten the bolt by using the supplied tool or similar tool.

Note: *For less wind noise and better aerodynamics, only install the crossbars when you need them for carrying cargo.*

LOAD LIMIT

Vehicle Loading - with and without a Trailer

This section guides you in the proper loading of your vehicle, trailer, or both. Keep your loaded vehicle weight within its design rating capability, with or without a trailer. Properly loading your vehicle provides maximum return of vehicle design performance. Before you load your vehicle, become familiar with the following terms for determining your vehicle's weight rating, with or without a trailer, from the vehicle's Tire and Loading Information label or Safety Compliance Certification label.

Load Carrying

Tire and Loading Label Information Example:



TIRE AND LOADING INFORMATION

SEATING CAPACITY TOTAL: 5 FRONT: 2 REAR: 3

The combined weight of occupants, and cargo should never exceed **385 kg or 850 lbs.**

TIRE	SIZE	COLD TIRE PRESSURE
FRONT	235/45R18 94V	235 KPA, 34 PSI
REAR	235/45R18 94V	235 KPA, 34 PSI
SPARE	NONE	NONE

SEE OWNERS
MANUAL FOR
ADDITIONAL
INFORMATION



TIRE AND LOADING INFORMATION RENSEIGNEMENTS SUR LES PNEUS ET LE CHARGEMENT

SEATING CAPACITY / NOMBRE DE PLACES TOTAL 5 FRONT AVANT 2 REAR ARRIERE 3

The combined weight of occupants and cargo should never exceed 396 kg or 875 lbs. / Le poids total des occupants et du chargement ne doit jamais dépasser 396 kg ou 875 lbs.

TIRE / PNEU	SIZE / DIMENSIONS	COLD TIRE PRESSURE / PRESSION DES PNEUS A FROID
FRONT / AVANT	235/40R19 96V	255 KPA, 37 PSI
REAR / ARRIERE	235/40R19 96V	255 KPA, 37 PSI
SPARE / SECOURS	T125/80R16 97M	415 KPA, 60 PSI

SEE OWNER'S
MANUAL FOR
ADDITIONAL
INFORMATION
VOIR LE MANUEL
DE L'USAGER
POUR PLUS DE
RENSEIGNEMENTS

Payload

Payload is the combined weight of cargo and passengers that your vehicle is carrying. The maximum payload for your vehicle appears on the Tire and Loading label. The label is either on the B-pillar or the edge of the driver door. Vehicles exported outside the US and Canada may not have a tire and loading label. Look for "The combined weight of occupants and cargo should never exceed XXX kg OR XXX lb" for maximum payload. The payload listed on the Tire and Loading Information label

is the maximum payload for your vehicle as built by the assembly plant. If you install any additional equipment on your vehicle, you must determine the new payload. Subtract the weight of the equipment from the payload listed on the Tire and Loading label. When towing, trailer tongue weight or king pin weight is also part of payload.



WARNING:

The appropriate loading capacity of your vehicle can be limited either by volume capacity (how much space is available) or by payload capacity (how much weight the vehicle should carry). Once you have reached the maximum payload of your vehicle, do not add more cargo, even if there is space available. Overloading or improperly loading your vehicle can contribute to loss of vehicle control and vehicle rollover.

GAWR (Gross Axle Weight Rating)

GAWR is the maximum allowable weight that a single axle (front or rear) can carry. These numbers are on the Safety Compliance Certification label. The label is located on the door hinge pillar, door-latch post, or the door edge that meets the door-latch post, next to the driver seating position.

Load Carrying

The total load on each axle must never exceed its Gross Axle Weight Rating.

GVWR (Gross Vehicle Weight Rating)

GVWR is the maximum allowable weight of the fully loaded vehicle. This includes all options, equipment, passengers and cargo. It appears on the Safety Compliance Certification label. The label is located on the door hinge pillar, door-latch post, or the door edge that meets the door-latch post, next to the driver seating position.

The gross vehicle weight must never exceed the Gross Vehicle Weight Rating.

Safety Compliance Certification Label Example:

MFD. BY FORD MOTOR CO. QTR: XXXX (XXX) (L)			
DATE: XXXX	FRONT GVWR:	REAR GVWR:	WEIGHT:
XXXXXX (XXXX) (L)	XXXXXX (XXXX) (L)	XXXXXX (XXXX) (L)	XXXXXX (XXXX) (L)
XXXXXX (XXXX) (L)	TIRES: XXXXXXXXXXXXXXX	TIRES: XXXXXXXXXXXXXXX	TIRES: XXXXXXXXXXXXXXX
XXXXXX	TIRES: XXXXXXX	TIRES: XXXXXXX	TIRES: XXXXXXX
AT XXXX KPa/ XXX PSI (COLD)	AT XXXX KPa/ XXX PSI (COLD)	AT XXXX KPa/ XXX PSI (COLD)	AT XXXX KPa/ XXX PSI (COLD)
THIS VEHICLE CONFORMS TO ALL APPLICABLE FEDERAL MOTOR VEHICLE SAFETY AND THEFT PREVENTION STANDARDS IN EFFECT ON THE DATE OF MANUFACTURE SHOWN ABOVE.			
VIN: XXXXXXXXXXXXXXXXXXXXX		VIN: XXXXXXX	
FRONT: XX XXXXX AS X H25 XXX BB MHTR H199 TE TABE TH F199 I XXX XXX XX X X X XXX XXX XXXXXXXXXXXXXXX XXX XXXXXXXXXXXXXXX	MFD. BY FORD MOTOR CO. QTR: XXXX (XXX) (L)		
DATE: XXXX	FRONT GVWR/PBSE AY:	REAR GVWR/PBSE AR:	WEIGHT:
XXXXXX (XXXX) (L)	XXXXXX (XXXX) (L)	XXXXXX (XXXX) (L)	XXXXXX (XXXX) (L)
XXXXXX (XXXX) (L)	TIRES: XXXXXXXXXXXXXXX	TIRES: XXXXXXXXXXXXXXX	TIRES: XXXXXXXXXXXXXXX
XXXXXX (XXXX) (L)	TIRES: XXXXXXX	TIRES: XXXXXXX	TIRES: XXXXXXX
AT XXXX KPa/ XXX PSI (COLD)	AT XXXX KPa/ XXX PSI (COLD)	AT XXXX KPa/ XXX PSI (COLD)	AT XXXX KPa/ XXX PSI (COLD)
THIS VEHICLE CONFORMS TO ALL APPLICABLE FEDERAL MOTOR VEHICLE SAFETY AND THEFT PREVENTION STANDARDS IN EFFECT ON THE DATE OF MANUFACTURE SHOWN ABOVE.			
VIN: XXXXXXXXXXXXXXXXXXXXX		VIN: XXXXXXX	
FRONT: XX XXXXX AS X H25 XXX BB MHTR H199 TE TABE TH F199 I XXX XXX XX X X X XXX XXX XXXXXXXXXXXXXXX XXX XXXXXXXXXXXXXXX	MFD. BY FORD MOTOR CO. QTR: XXXX (XXX) (L)		
DATE: XXXX	FRONT GVWR/PBSE AY:	REAR GVWR/PBSE AR:	WEIGHT:
XXXXXX (XXXX) (L)	XXXXXX (XXXX) (L)	XXXXXX (XXXX) (L)	XXXXXX (XXXX) (L)
XXXXXX (XXXX) (L)	TIRES: XXXXXXXXXXXXXXX	TIRES: XXXXXXXXXXXXXXX	TIRES: XXXXXXXXXXXXXXX
XXXXXX (XXXX) (L)	TIRES: XXXXXXX	TIRES: XXXXXXX	TIRES: XXXXXXX
AT XXXX KPa/ XXX PSI (COLD)	AT XXXX KPa/ XXX PSI (COLD)	AT XXXX KPa/ XXX PSI (COLD)	AT XXXX KPa/ XXX PSI (COLD)
THIS VEHICLE CONFORMS TO ALL APPLICABLE FEDERAL MOTOR VEHICLE SAFETY AND THEFT PREVENTION STANDARDS IN EFFECT ON THE DATE OF MANUFACTURE SHOWN ABOVE.			
VIN: XXXXXXXXXXXXXXXXXXXXX		VIN: XXXXXXX	
FRONT: XX XXXXX AS X H25 XXX BB MHTR H199 TE TABE TH F199 I XXX XXX XX X X X XXX XXX XXXXXXXXXXXXXXX XXX XXXXXXXXXXXXXXX	MFD. BY FORD MOTOR CO. QTR: XXXX (XXX) (L)		



WARNING: Exceeding the Safety Compliance Certification label vehicle weight limits can adversely affect the performance and handling of your vehicle, cause vehicle damage and can result in the loss of control of your vehicle, serious personal injury or death.

Maximum Loaded Trailer Weight

Maximum loaded trailer weight is the highest possible weight of a fully loaded trailer the vehicle can tow. Consult an authorized dealer (or the RV and Trailer Towing Guide available at an authorized dealer) for more detailed information.

GCWR (Gross Combined Weight Rating)

GCWR is the maximum allowable weight of the vehicle and the loaded trailer, including all cargo and passengers, that the vehicle can handle without risking damage. (Important: The towing vehicle's braking system is rated for operation at Gross Vehicle Weight Rating, not at Gross Combined Weight Rating.) Separate functional brakes should

Load Carrying

be used for safe control of towed vehicles and for trailers where the Gross Combined Weight of the towing vehicle plus the trailer exceed the Gross Vehicle Weight Rating of the towing vehicle.

The gross combined weight must never exceed the Gross Combined Weight Rating.

Note: For trailer towing information refer to the *RV and Trailer Towing Guide* available at an authorized dealer.



WARNING: Do not exceed the GVWR or the GAWR specified on the certification label.



WARNING: Do not use replacement tires with lower load carrying capacities than the original tires because they may lower your vehicle's GVWR and GAWR limitations. Replacement tires with a higher limit than the original tires do not increase the GVWR and GAWR limitations.



WARNING: Exceeding any vehicle weight rating can adversely affect the performance and handling of your vehicle, cause vehicle damage and can result in the loss of control of your vehicle, serious personal injury or death.

Steps for determining the correct load limit:

1. Locate the statement "The combined weight of occupants and cargo should never exceed XXX kg or XXX lb." on your vehicle's placard.
2. Determine the combined weight of the driver and passengers that will be riding in your vehicle.
3. Subtract the combined weight of the driver and passengers from XXX kg or XXX lb.
4. The resulting figure equals the available amount of cargo and luggage load capacity. For example, if the "XXX" amount equals 1,400 lb. and there will be five 150 lb. passengers in your vehicle, the amount of available cargo and luggage load capacity is 650 lb. $(1400 - (5 \times 150) = 1400 - 750 = 650 \text{ lb.})$
5. Determine the combined weight of luggage and cargo being loaded on the vehicle. That weight may not safely exceed the available cargo and luggage load capacity calculated in Step 4.
6. If your vehicle will be towing a trailer, load from your trailer will be transferred to your vehicle. Consult this manual to determine how this reduces the available cargo and luggage load capacity of your vehicle.

Load Carrying

Helpful examples for calculating the available amount of cargo and luggage load capacity

Suppose your vehicle has a 1400-pound (635-kilogram) cargo and luggage capacity. You decide to go golfing. Is there enough load capacity to carry you, four of your friends and all the golf bags? You and four friends average 220 pounds (99 kilograms) each and the golf bags weigh approximately 30 pounds (13.5 kilograms) each. The calculation would be: $1400 - (5 \times 220) - (5 \times 30) = 1400 - 1100 - 150 = 150$ pounds. Yes, you have enough load capacity in your vehicle to transport four friends and your golf bags. In metric units, the calculation would be: $635 \text{ kilograms} - (5 \times 99 \text{ kilograms}) - (5 \times 13.5 \text{ kilograms}) = 635 - 495 - 67.5 = 72.5$ kilograms.

Suppose your vehicle has a 1400-pound (635-kilogram) cargo and luggage capacity. You and one of your friends decide to pick up cement from the local home improvement store to finish that patio you have been planning for the past two years. Measuring the inside of the vehicle with the rear seat folded down, you have room for twelve 100-pound (45-kilogram) bags of cement. Do you have enough load capacity to transport the cement to your home? If you and your friend each weigh 220 pounds (99 kilograms), the calculation would be: $1400 - (2 \times 220) - (12 \times 100) = 1400 - 440$

$- 1200 = - 240$ pounds. No, you do not have enough cargo capacity to carry that much weight. In metric units, the calculation would be: $635 \text{ kilograms} - (2 \times 99 \text{ kilograms}) - (12 \times 45 \text{ kilograms}) = 635 - 198 - 540 = -103$ kilograms. You will need to reduce the load weight by at least 240 pounds (104 kilograms). If you remove three 100-pound (45-kilogram) cement bags, then the load calculation would be: $1400 - (2 \times 220) - (9 \times 100) = 1400 - 440 - 900 = 60$ pounds. Now you have the load capacity to transport the cement and your friend home. In metric units, the calculation would be: $635 \text{ kilograms} - (2 \times 99 \text{ kilograms}) - (9 \times 45 \text{ kilograms}) = 635 - 198 - 405 = 32$ kilograms.

The above calculations also assume that the loads are positioned in your vehicle in a manner that does not overload the front or the rear gross axle weight rating specified for your vehicle on the Safety Compliance Certification label.

Special Loading Instructions for Owners of Pick-up Trucks and Utility-type Vehicles



WARNING: When loading the roof racks, we recommend you evenly distribute the load, as well as maintain a low center of gravity. Loaded vehicles, with higher centers of gravity, may

Load Carrying

handle differently than unloaded vehicles. Take extra precautions, such as slower speeds and increased stopping distance, when driving a heavily loaded vehicle.

Towing

TOWING A TRAILER



WARNING: Towing trailers beyond the maximum recommended gross trailer weight exceeds the limit of your vehicle and could result in engine damage, transmission damage, structural damage, loss of vehicle control, vehicle rollover and personal injury.



WARNING: Do not exceed the GVWR or the GAWR specified on the certification label.

Note: See **Recommended Towing Weights** (page 284).

Your vehicle may have electrical items, such as fuses or relays, related to towing. See **Fuses** (page 305).

Your vehicle's load capacity designation is by weight, not by volume, so you cannot necessarily use all available space when loading a vehicle or trailer.

Towing a trailer places an extra load on your vehicle's engine, transmission, axle, brakes, tires and suspension. Inspect these components periodically during, and after, any towing operation.

Load Placement

To help minimize how trailer movement affects your vehicle when driving:

- Load the heaviest items closest to the trailer floor.
- Load the heaviest items centered between the left and right side trailer tires.
- Load the heaviest items above the trailer axles or just slightly forward toward the trailer tongue. Do not allow the final trailer tongue weight to go above or below 10-15% of the loaded trailer weight.
- Select a ball mount with the correct rise or drop and load capacity. When both the loaded vehicle and trailer are connected, the trailer frame should be level, or slightly angled down toward your vehicle, when viewed from the side.

When driving with a trailer or payload, a slight takeoff vibration or shudder may be present due to the increased payload weight. Additional information regarding proper trailer loading and setting your vehicle up for towing is located in another chapter of this manual. See **Load Limit** (page 277).

You can also find information in the **RV & Trailer Towing Guide** available at your authorized dealer, or online.

Towing

RV & Trailer Towing Guide Online

Website | <http://www.fleet.ford.com/towing-guides/>

TRAILER SWAY CONTROL



WARNING: Turning off trailer sway control increases the risk of loss of vehicle control, serious injury or death. Ford does not recommend disabling this feature except in situations where speed reduction may be detrimental (such as hill climbing), the driver has significant trailer towing experience, and can control trailer sway and maintain safe operation.

Note: This feature does not prevent trailer sway, but reduces it when it begins.

Note: This feature cannot stop all trailers from swaying.

Note: In some cases, if your vehicle speed is too high, the system may turn on multiple times, gradually reducing your vehicle speed.

The system applies the brakes to the individual wheels and reduces engine torque to aid vehicle stability. If the trailer begins to sway, the stability control warning lamp flashes and a message appears in the information display. See **Information Messages** (page 119). Slow your vehicle down, pull safely to the side of the road and check for correct load distribution. See **Load Carrying** (page 275).

You can switch this feature off in the information display. When you switch the ignition on, the system automatically turns on.

RECOMMENDED TOWING WEIGHTS

Market	Website
United States of America	https://www.fleet.ford.com/towing-guides/
Canada	https://www.fleet.ford.ca/towing-guides/

Towing

ESSENTIAL TOWING CHECKS

Follow these guidelines for safe towing:

- Do not tow a trailer until you drive your vehicle at least 1,000 mi (1,600 km).
- Consult your local motor vehicle laws for towing a trailer.
- See the instructions included with towing accessories for the proper installation and adjustment specifications.
- Service your vehicle more frequently if you tow a trailer. See **Scheduled Maintenance** (page 476).
- If you use a rental trailer, follow the instructions the rental agency gives you.

You can find information on load specification terms found on the tire label and Safety Compliance label as well as instructions on calculating your vehicle's load in the Load Carrying chapter. See **Load Limit** (page 277).

Remember to account for the trailer tongue weight as part of your vehicle load when calculating the total vehicle weight.

Hitches

Do not use a hitch that either clamps onto the bumper or attaches to the axle.

Distribute the trailer load so 10-15% of the total trailer weight is on the tongue.

A weight distributing hitch is not required for your vehicle.

Safety Chains

Note: Do not attach safety chains to the bumper.

Always connect the safety chains to the hook retainers of your vehicle hitch.

To connect the trailer's safety chains, cross them under the trailer tongue and allow enough slack for turning tight corners. Do not allow the chains to drag on the ground.

Trailer Brakes



WARNING: Do not connect a trailer's hydraulic brake system directly to your vehicle's brake system. Your vehicle may not have enough braking power and your chances of having a collision greatly increase.

Electric brakes and manual, automatic or surge-type trailer brakes are safe if you install them properly and adjust them to the manufacturer's specifications. The trailer brakes must meet local and federal regulations.

The rating for the tow vehicle's braking system operation is at the gross vehicle weight rating, not the gross combined weight rating.

Safe control of towed vehicles requires separate functioning brake systems for vehicles and trailers weighing more than 1,500 lb (680 kg) when loaded.

Trailer Lamps



WARNING: Never connect any trailer lamp wiring to the vehicle's tail lamp wiring; this may damage the electrical system resulting in fire. Contact your authorized dealer as soon as possible for assistance in proper trailer tow wiring installation. Additional electrical equipment may be required.

Most towed vehicles require trailer lamps. Make sure all running lights, brake lights, direction indicators and hazard flashers are working.

Towing

Before Towing a Trailer

Practice turning, stopping and backing up to get the feel of your vehicle-trailer combination before starting on a trip. When turning, make wider turns so the trailer wheels clear curbs and other obstacles.

When Towing a Trailer

- Do not drive faster than 70 mph (113 km/h) during the first 500 mi (800 km).
- Do not make full-throttle starts.
- Check your hitch, electrical connections and trailer wheel lug nuts thoroughly after you have traveled 50 mi (80 km).
- When stopped in congested or heavy traffic during hot weather, place the gearshift in park (P) to aid engine and transmission cooling and to help A/C performance.
- Turn off the speed control with heavy loads or in hilly terrain. The speed control may turn off automatically when you are towing on long, steep grades.
- Shift to a lower gear when driving down a long or steep hill. Do not apply the brakes continuously, as they may overheat and become less effective.
- If your transmission is equipped with a Grade Assist or Tow/Haul feature, use this feature when towing. This provides engine braking and helps eliminate excessive transmission shifting for optimum fuel economy and transmission cooling.
- Allow more distance for stopping with a trailer attached. Anticipate stops and brake gradually.
- Avoid parking on a grade. However, if you must park on a grade:
 1. Turn the steering wheel to point your vehicle tires away from traffic flow.

2. Set your vehicle parking brake.
3. Place the automatic transmission in park (P).
4. Place wheel chocks in front and back of the trailer wheels. (Chocks not included with vehicle.)

Launching or Retrieving a Boat or Personal Watercraft (PWC)

Note: Disconnect the wiring to the trailer **before** backing the trailer into the water.

Note: Reconnect the wiring to the trailer **after** removing the trailer from the water.

When backing down a ramp during boat launching or retrieval:

- Do not allow the static water level to rise above the bottom edge of the rear bumper.
- Do not allow waves to break higher than 6 in (15 cm) above the bottom edge of the rear bumper.

Exceeding these limits may allow water to enter vehicle components:

- Causing internal damage to the components.
- Affecting driveability, emissions, and reliability.

Replace the rear axle lubricant anytime the rear axle has been submerged in water. Water may have contaminated the rear axle lubricant, which is not normally checked or changed unless a leak is suspected or other axle repair is required.

Towing

TOWING THE VEHICLE ON FOUR WHEELS

Emergency Towing



WARNING: If your vehicle has a steering wheel lock make sure the ignition is in the accessory or on position when being towed.

If your vehicle becomes inoperable without access to wheel dollies or a vehicle transport trailer, it can be flat-towed with all wheels on the ground, regardless of the powertrain and transmission configuration, under the following conditions:

- Your vehicle is facing forward for towing in a forward direction.
- Refer to the Manual Park Release procedure. See **Automatic Transmission** (page 197). Failing to do so could result in damage to the transmission.
- Maximum speed is 35 mph (56 km/h).
- Maximum distance is 50 mi (80 km).

Note: *If you are unsure of the vehicle's configuration, contact an authorized dealer.*

Recreational Towing - Front-Wheel Drive Vehicles (If Equipped)

You cannot recreational tow your vehicle with all wheels on the ground because vehicle or transmission damage could occur. Place the front wheels on a two-wheel tow dolly. If you are using a tow dolly, follow the instructions specified by the equipment provider.

Recreational Towing - Rear-Wheel Drive Vehicles (If Equipped)

You cannot recreational tow your vehicle with all wheels on the ground because vehicle or transmission damage could occur. We recommend towing your vehicle with all four wheels off the ground, such as when using a car-hauling trailer. Otherwise, you cannot recreational tow your vehicle.

Recreational Towing - All-Wheel and Four-Wheel Drive Vehicles (If Equipped)

You cannot recreational tow your vehicle with all wheels on the ground because vehicle or transmission damage could occur. We recommend towing your vehicle with all four wheels off the ground, such as when using a car-hauling trailer. Otherwise, you cannot recreational tow your vehicle.

Driving Hints

REDUCED ENGINE PERFORMANCE



WARNING: If you continue to drive your vehicle when the engine is overheating, the engine could stop without warning. Failure to follow this instruction could result in the loss of control of your vehicle.

If the engine coolant temperature gauge needle moves to the upper limit position, the engine is overheating. See **Gauges** (page 104).

You must only drive your vehicle for a short distance if the engine overheats. The distance you can travel depends on ambient temperature, vehicle load and terrain. The engine continues to operate with limited power for a short period of time.

If the engine temperature continues to rise, the fuel supply to the engine reduces. The air conditioning switches off and the engine cooling fan operates continually.

1. Gradually reduce your speed and stop your vehicle as soon as it is safe to do so.
2. Immediately switch the engine off to prevent severe engine damage.
3. Wait for the engine to cool down.
4. Check the coolant level. See **Engine Coolant Check** (page 324).
5. Have your vehicle checked as soon as possible.

COLD WEATHER PRECAUTIONS

The functional operation of some components and systems can be affected at temperatures below approximately -13°F (-25°C).

BREAKING-IN

Your vehicle requires a break-in period. For the first 1,000 mi (1,600 km), avoid driving at high speeds, heavy braking, aggressive shifting or using your vehicle to tow. During this time, your vehicle may exhibit some unusual driving characteristics.

DRIVING ECONOMICALLY

The following helps to improve fuel consumption:

- Drive smoothly, accelerate gently and anticipate the road ahead to avoid heavy braking.
- Regularly check your tire pressures and make sure that they are inflated to the correct pressure.
- Follow the recommended maintenance schedule and carry out the recommended checks.
- Plan your journey and check the traffic before you set off. It is more efficient to combine errands into a single trip whenever possible.
- Avoid idling the engine in cold weather or for extended periods. Start the engine only when you are ready to set off.
- Do not carry unnecessary weight in your vehicle as extra weight wastes fuel.

Driving Hints

- Do not add unnecessary accessories to the exterior of your vehicle, for example running boards. If you use a roof rack, remember to fold it down or remove it when not in use.
- Do not shift into neutral when you are braking or when your vehicle is slowing down.
- Shut all windows when driving at high speeds.
- Switch off all electric systems when not in use, for example air conditioning. Make sure that you unplug any accessories from the auxiliary power points when not in use.

DRIVING THROUGH SHALLOW WATER



WARNING: Do not attempt to cross a deep or flowing body of water. Failure to follow this instruction could result in the loss of control of your vehicle, personal injury or death.

Note: *Driving through standing water can cause vehicle damage.*

Note: *Engine damage can occur if water enters the air filter.*

Before driving through standing water, check the depth. Never drive through water that is higher than the bottom of the front rocker area of your vehicle.



When driving through standing water, drive very slowly and do not stop your vehicle. Your brake performance and traction could be limited. After driving through water and as soon as it is safe to do so:

- Lightly press the brake pedal to dry the brakes and to check that they work.
- Turn the steering wheel to check that the steering power assist works.

Check the function of the following:

- Horn
- Exterior lights

FLOOR MATS



WARNING: Use a floor mat designed to fit the footwell of your vehicle that does not obstruct the pedal area. Failure to follow this instruction could result in the loss of control of your vehicle, personal injury or death.



WARNING: Pedals that cannot move freely can cause loss of vehicle control and increase the risk of serious personal injury.

Driving Hints



WARNING: Secure the floor mat to both retention devices so that it cannot slip out of position and interfere with the pedals. Failure to follow this instruction could result in the loss of control of your vehicle, personal injury or death.



WARNING: Do not place additional floor mats or any other covering on top of the original floor mats. This could result in the floor mat interfering with the operation of the pedals. Failure to follow this instruction could result in the loss of control of your vehicle, personal injury or death.



WARNING: Always make sure that objects cannot fall into the driver foot well while your vehicle is moving. Objects that are loose can become trapped under the pedals causing a loss of vehicle control.

Note: Regularly check the floor mats to make sure they are secure.



To install floor mats that have eyelets, position the floor mat eyelet over the retention post and press down to lock in position. Repeat for all eyelets on the floor mat.

To remove the floor mats, reverse the installation procedure.

Roadside Emergencies

ROADSIDE ASSISTANCE

Vehicles Sold in the United States: Getting Roadside Assistance

To fully assist you should you have a vehicle concern, Ford Motor Company offers a complimentary roadside assistance program. This program is separate from the New Vehicle Limited Warranty.

The service is available:

- 24 hours a day, seven days a week.
- For the coverage period supplied with your vehicle.

Roadside Assistance covers:

- A flat tire change with a good spare (except vehicles supplied with a tire inflation kit).
- Battery jump start.
- Lock-out assistance (key replacement cost is the customer's responsibility).
- Fuel delivery — independent service contractors, if not prohibited by state, local or municipal law, shall deliver up to 2 gal (8 L) of gasoline or 5 gal (20 L) of diesel fuel to a disabled vehicle. Roadside Assistance limits fuel delivery service to two no-charge occurrences within a 12-month period.
- Winch out — available within 100 ft (30 m) of a paved or county maintained road, no recoveries.

- Towing — independent service contractors, if not prohibited by state, local or municipal law, shall tow Ford eligible vehicles to an authorized dealer within 35 mi (56 km) of the disablement location or to the nearest authorized dealer. If a member requests a tow to an authorized dealer that is more than 35 mi (56 km) from the disablement location, the member shall be responsible for any mileage costs in excess of 35 mi (56 km).
- Roadside Assistance includes up to \$200 for a towed trailer if the disabled eligible vehicle requires service at the nearest authorized dealer. If the towing vehicle is operational but the trailer is not, then the trailer does not qualify for any roadside services.

Vehicles Sold in the United States: Using Roadside Assistance

Complete the roadside assistance identification card and place it in your wallet for quick reference. This card is in the Owner's Manual kit.

United States vehicle customers who require Roadside Assistance, call 1-800-241-3673.

If you need to arrange roadside assistance for yourself, Ford Motor Company reimburses a reasonable amount for towing to the nearest dealership within 35 mi (56 km). To obtain reimbursement information, United States vehicle customers call 1-800-241-3673. Customers need to submit their original receipts.

Roadside Emergencies

Vehicles Sold in Canada: Getting Roadside Assistance

To fully assist you should you have a vehicle concern, Ford Motor Company of Canada, Limited offers a complimentary roadside assistance program. This program is eligible within Canada or the continental United States.

The service is available 24 hours a day, seven days a week.

This program is separate from the New Vehicle Limited Warranty, but the coverage is concurrent with the powertrain coverage period of your vehicle. Canadian roadside coverage and benefits may differ from the U.S. coverage.

If you require more information, please call us in Canada at 1-800-665-2006, or visit our website at www.ford.ca.

HAZARD FLASHERS

Note: *The hazard flashers operate when the ignition is in any position, or if the key is not in the ignition. If used when the vehicle is not running, the battery loses charge. As a result, there may be insufficient power to restart your vehicle.*



The flasher control is on the instrument panel. Use your hazard flashers when your vehicle is creating a safety hazard for other motorists.

- Press the flasher control and all front and rear direction indicators flash.
- Press the button again to switch them off.

FUEL SHUTOFF



WARNING: If your vehicle has been involved in a crash, have the fuel system checked. Failure to follow this instruction could result in fire, personal injury or death.

Note: *When you try to restart your vehicle after a fuel shutoff, the vehicle makes sure that various systems are safe to restart. Once the vehicle determines the systems are safe, then the vehicle allows you to restart.*

Note: *In the event that your vehicle does not restart after your third attempt, contact a qualified technician.*

The fuel pump shutoff stops the flow of fuel to the engine in the event of a moderate to severe crash. Not every impact causes a shutoff.

Should your vehicle shut off after a crash, you may restart your vehicle.

If your vehicle has a key system:

1. Switch off the ignition.
2. Switch to start position.
3. Switch off the ignition.
4. Switch on the ignition to re-enable the fuel pump.
5. If the vehicle does not start, repeat steps 1 through 4.

If your vehicle has a push button start system:

1. Press **START/STOP** to switch off your vehicle.
2. Press the brake pedal and **START/STOP** to switch on your vehicle.
3. Remove your foot from the brake pedal and press **START/STOP** to switch off your vehicle.

Roadside Emergencies

- You can attempt to start the vehicle by pressing the brake pedal and **START/STOP**, or press **START/STOP** without pressing the brake pedal.
- If the vehicle does not start, repeat steps 1 through 4.

JUMP STARTING THE VEHICLE



WARNING: Batteries normally produce explosive gases which can cause personal injury. Therefore, do not allow flames, sparks or lighted substances to come near the battery. When working near the battery, always shield your face and protect your eyes. Always provide correct ventilation.



WARNING: Keep batteries out of reach of children. Batteries contain sulfuric acid. Avoid contact with skin, eyes or clothing. Shield your eyes when working near the battery to protect against possible splashing of acid solution. In case of acid contact with skin or eyes, flush immediately with water for a minimum of 15 minutes and get prompt medical attention. If acid is swallowed, call a physician immediately.



WARNING: Use only adequately sized cables with insulated clamps.

Preparing Your Vehicle

Do not attempt to push-start your automatic transmission vehicle.

Note: Attempting to push-start a vehicle with an automatic transmission may cause transmission damage.

Note: Use only a 12-volt supply to start your vehicle.

Note: Do not disconnect the battery of the disabled vehicle as this could damage the vehicle electrical system.

Park the booster vehicle close to the hood of the disabled vehicle, making sure the two vehicles do not touch.

Locating the Jump Starting Connection Points

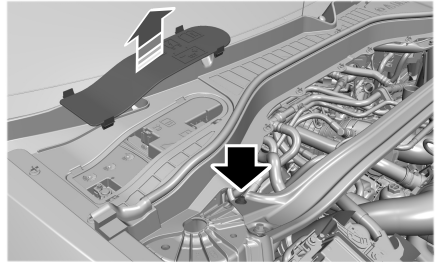

E288229

- Open the hood. See **Opening and Closing the Hood** (page 315).
- Remove the access cover.
- Remove the red protective cover from the positive lead jump connection point.
- Locate the negative jump connection point on the rear mounting bolt for the cross brace, as shown.

Connecting the Jumper Cables



WARNING: If the engine is running while the hood is open, stay clear of moving engine components. Failure to follow this warning could result in serious personal injury or death.



WARNING: Do not connect the negative jumper cable to any other part of your vehicle. Use the ground point.

Roadside Emergencies

Note: In the illustration, the bottom vehicle represents the booster vehicle.

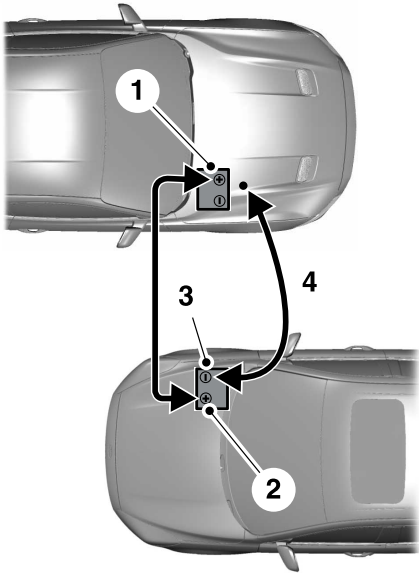

1. Connect the positive (+) jumper cable to the positive (+) terminal of the discharged battery.
2. Connect the other end of the positive (+) cable to the positive (+) terminal of the booster vehicle battery.
3. Connect the negative (-) cable to the negative (-) terminal of the booster vehicle battery.
4. Make the final connection of the negative (-) cable to an exposed metal part of the stalled vehicle's engine, away from the battery and the fuel injection system, or connect the negative (-) cable to a ground connection point if available.

Jump Starting

Note: If you are using a hybrid vehicle as the booster vehicle, you do not need to rev the engine.

1. Start the engine of the booster vehicle and rev the engine moderately, or press the accelerator gently to keep your engine speed between 2000 and 3000 RPM, as shown in your tachometer.
2. Start the engine of the disabled vehicle.
3. Once the disabled vehicle has been started, run both vehicle engines for an additional three minutes before disconnecting the jumper cables.

Removing the Jumper Cables

Remove the jumper cables in the reverse order that they were connected.

1. Remove the negative (-) jumper cable from the disabled vehicle.
2. Remove the jumper cable on the negative (-) terminal of the booster vehicle battery.
3. Remove the jumper cable from the positive (+) terminal of the booster vehicle battery.
4. Remove the jumper cable from the positive (+) terminal of the disabled vehicle battery.
5. Allow the engine to idle for at least one minute.

Roadside Emergencies

COLLISION, DAMAGE OR FIRE EVENT

Guidance for Ford Motor Company Electric and Hybrid-Electric Vehicles Equipped With High Voltage Batteries

(Vehicle Owner/Operator/General Public) Electric and Hybrid-Electric Vehicle Considerations

In the event of damage or fire involving an electric vehicle or hybrid-electric vehicle:

- Always assume the high-voltage battery and associated components are energized and fully charged.
- Exposed electrical components, wires, and high-voltage batteries present potential high-voltage shock hazards.
- Venting high-voltage battery vapors are potentially toxic and flammable.
- Physical damage to the vehicle or high-voltage battery may result in immediate or delayed release of toxic, flammable gases and fire.

Vehicle information and general safety practices:

- Know the make and model of your vehicle.
- Review the owner's manual and become familiar with your vehicle's safety information and recommended safety practices.
- Do not attempt to repair damaged electric and hybrid-electric vehicles yourself.

Contact an authorized dealer.

Crashes

A crash or impact significant enough to require an emergency response for conventional vehicles would also require the same response for an electric or hybrid-electric vehicle.

If possible:

- Move your vehicle to a safe, nearby location and remain on the scene.
- Roll down the windows before switching your vehicle off.
- Place your vehicle in park (P), set the parking brake, switch off the vehicle, activate the hazard warning flashers and move your key(s) at least 15 ft (5 m) away from the vehicle.

Always:

- Call emergency assistance if needed and advise that an electric or hybrid-electric vehicle is involved.
- Exposed electrical components, wires, and high-voltage batteries present potential high-voltage shock hazards.
- Avoid contact with leaking fluids and gases, and remain out of the way of oncoming traffic until emergency responders arrive.
- When emergency responders arrive, tell them that the vehicle involved is an electric vehicle or hybrid-electric vehicle.

Fires

As with any vehicle, call emergency assistance immediately if you see sparks, smoke or flames coming from the vehicle. Remain a safe distance from the vehicle and try to stay clear of the smoke.

- Exit the vehicle immediately.
- Advise emergency assistance that an electric or hybrid-electric vehicle is involved.

Roadside Emergencies

- As with any vehicle fire, do not inhale smoke, vapors or gas from the vehicle, as they may be hazardous.
- Stay out of the roadway and stay out of the way of any oncoming traffic while awaiting the arrival of emergency responders.

Post-Incident

- Do not store a severely damaged vehicle with a lithium-ion battery inside a structure or within 49 ft (15 m) of any structure or vehicle.
- Make sure that passenger and luggage compartments remain ventilated.
- Call emergency assistance if you observe leaking fluids, sparks, smoke or flames, or hear gurgling or bubbling from the high-voltage battery.

POST-CRASH ALERT SYSTEM

The system flashes the direction indicators and sounds the horn (intermittently) in the event of a serious impact that deploys an airbag (front, side, side curtain or Safety Canopy) or the seatbelt pretensioners.

The horn and indicators turn off when:

- You press the hazard control button.
- You press the panic button on the remote entry transmitter (if equipped).
- Your vehicle runs out of power.
- Sounding of the horn is only enabled in specific markets.

TRANSPORTING THE VEHICLE

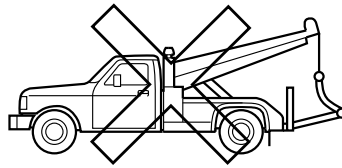
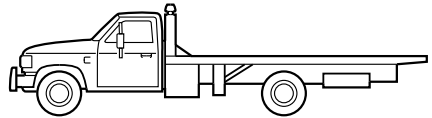
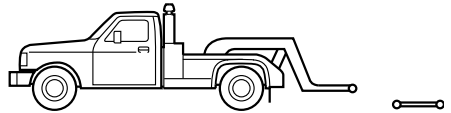

If you need to tow your vehicle, contact a professional towing service or, if you are a member of a roadside assistance program, your roadside assistance service provider.

We recommend the use of a wheel lift and dollies or flatbed equipment to tow your vehicle. Do not tow with a slingbelt. We do not approve a slingbelt towing procedure. If you tow your vehicle incorrectly, or by any other means, vehicle damage may occur.

We produce a towing manual for all authorized tow truck operators. Have your tow truck operator refer to this manual for proper hook-up and towing procedures for your vehicle.

Roadside Emergencies

Towing an all-wheel or four-wheel drive vehicle requires that all wheels be off the ground, such as using a wheel lift and dollies or flatbed equipment. Wheel lift may only be done by lifting the rear wheels and putting the front wheels on dollies. This prevents damage to the transmission, all-wheel or four-wheel drive system and vehicle.

If your vehicle becomes inoperable without access to wheel dollies, a car-hauling trailer or a flatbed transport vehicle, you can flat-tow with all wheels on the ground under limited conditions. See **Towing the Vehicle on Four Wheels** (page 287).

Customer Assistance

GETTING THE SERVICES YOU NEED

Warranty repairs to your vehicle must be performed by an authorized dealer. While any authorized dealer handling your vehicle line will provide warranty service, we recommend you return to your selling authorized dealer who wants to ensure your continued satisfaction.

Please note that certain warranty repairs require special training and equipment, so not all authorized dealers are authorized to perform all warranty repairs. This means that, depending on the warranty repair needed, you may have to take your vehicle to another authorized dealer.

A reasonable time must be allowed to perform a repair after taking your vehicle to the authorized dealer. Repairs will be made using Ford or Motorcraft® parts, or remanufactured or other parts that are authorized by Ford.

Away From Home

If you are away from home when your vehicle needs service, contact the Ford Customer Relationship Center or use the online resources listed below to find the nearest authorized dealer.

In the United States:

Mailing address

Ford Motor Company
Customer Relationship Center
P.O. Box 6248
Dearborn, MI 48126

Telephone

1-800-392-3673 (FORD)
TDD for the hearing impaired:
7-1-1 (where offered by your telephone service provider)

If your vehicle is configured as a motorhome please call 1-800-444-3311 for support.

Additional information and resources are available online:

Website
www.owner.ford.com

These are some of the items that can be found online:

- U.S. dealer locator by Dealer Name, City/State or Zip Code.
- Owner Manuals.
- Maintenance Schedules.
- Recalls.
- Ford Extended Service Plans.
- Ford Genuine Accessories.
- Service specials and promotions.

In Canada:

Mailing address

Customer Relationship Centre
Ford Motor Company of Canada, Limited
P.O. Box 2000
Oakville, Ontario L6K 0C8

Telephone

1-800-565-3673 (FORD)
TDD for the hearing impaired:
7-1-1 (where offered by your telephone service provider)

Website
www.ford.ca

Facebook

FordServiceCA (English)
FordServiceQC (Français)

Twitter

@FordServiceCA

Customer Assistance

Additional Assistance

If you have questions or concerns, or are unsatisfied with the service you are receiving, follow these steps:

1. Contact your Sales Representative or Service Advisor at your selling or servicing authorized dealer.
2. If your inquiry or concern remains unresolved, contact the Sales Manager, Service Manager or Customer Relations Manager.
3. If you require assistance or clarification on Ford Motor Company policies, please contact the Ford Customer Relationship Center.

In order to help us serve you better, please have the following information available when contacting a Customer Relationship Center:

- Vehicle Identification Number.
- Your telephone number (home and business).
- The name of the authorized dealer and city where located.
- The vehicle's current odometer reading.

In some states within the United States, you must directly notify Ford in writing before pursuing remedies under your state's warranty laws, and Ford is also allowed a final repair attempt.

Additionally, in some states within the United States, a consumer has the option of submitting a warranty dispute to the BBB Auto Line before taking action under the Magnuson-Moss Warranty Act, or to the extent allowed by state law, before pursuing replacement or repurchase remedies provided by certain state laws. This dispute handling procedure is not required prior to enforcing state created rights or other rights which are independent of the Magnuson-Moss Warranty Act or state replacement or repurchase laws.

IN CALIFORNIA (U.S. ONLY)

California Civil Code Section 1793.2(d) requires that, if a manufacturer or its representative is unable to repair a motor vehicle to conform to the vehicle's applicable express warranty after a reasonable number of attempts, the manufacturer shall be required to either replace the vehicle with one substantially identical or repurchase the vehicle and reimburse the buyer in an amount equal to the actual price paid or payable by the consumer (less a reasonable allowance for consumer use). The consumer has the right to choose whether to receive a refund or replacement vehicle.

California Civil Code Section 1793.22(b) presumes that the manufacturer has had a reasonable number of attempts to conform the vehicle to its applicable express warranties if, within the first 18 months of ownership of a new vehicle or the first 18,000 mi (29,000 km), whichever occurs first:

1. Two or more repair attempts are made on the same non-conformity likely to cause death or serious bodily injury OR
2. Four or more repair attempts are made on the same nonconformity (a defect or condition that substantially impairs the use, value or safety of the vehicle) OR
3. The vehicle is out of service for repair of nonconformities for a total of more than 30 calendar days (not necessarily all at one time).

In the case of 1 or 2 above, the consumer must also notify the manufacturer of the need for the repair of the nonconformity at the following address:

Ford Motor Company
16800 Executive Plaza Drive
Mail Drop 3NE-B
Dearborn, MI 48126

Customer Assistance

You are required to submit your warranty dispute to BBB AUTO LINE before asserting in court any rights or remedies conferred by California Civil Code Section 1793.22(b). You are also required to use BBB AUTO LINE before exercising rights or seeking remedies created by the Federal Magnuson-Moss Warranty Act, 15 U.S.C. sec. 2301 et seq. If you choose to seek redress by pursuing rights and remedies not created by California Civil Code Section 1793.22(b) or the Magnuson-Moss Warranty Act, resort to BBB AUTO LINE is not required by those statutes.

THE BETTER BUSINESS BUREAU (BBB) AUTO LINE PROGRAM (U.S. ONLY)

Your satisfaction is important to Ford Motor Company and to your dealer. If a warranty concern has not been resolved using the three-step procedure outlined earlier in this chapter in the Getting the Services you need section, you may be eligible to participate in the BBB AUTO LINE program.

The BBB AUTO LINE program consists of two parts – mediation and arbitration. During mediation, a representative of the BBB will contact both you and Ford Motor Company to explore options for settlement of the claim. If an agreement is not reached during mediation or you do not want to participate in mediation, and if your claim is eligible, you may participate in the arbitration process. An arbitration hearing will be scheduled so that you can present your case in an informal setting before an impartial person. The arbitrator considers the testimony provided and makes a decision after the hearing.

Disputes submitted to the BBB AUTO LINE program are usually decided within 40 days after you file your claim with the BBB. You are not bound by the decision, and may reject the decision and proceed to court where all findings of the BBB Auto Line dispute, and decision, are admissible in the court action. Should you choose to accept the BBB AUTO LINE decision, Ford is then bound by the decision, and must comply with the decision within 30 days of receipt of your acceptance letter.

BBB AUTO LINE Application: Using the information that follows, please call or write to request a program application. You will be asked for your name and address, general information about your new vehicle, information about your warranty concerns, and any steps you have already taken to try to resolve them. A Customer Claim Form will be mailed that needs to be completed, signed and returned to the BBB along with proof of ownership. Upon receipt, the BBB reviews the claim for eligibility under the Program Summary Guidelines.

You can get more information by calling BBB AUTO LINE at 1-800-955-5100, or writing to:

**BBB AUTO LINE a Division of BBB National Programs, Inc.
1676 International Drive, Suite 550
McLean, VA 22102**

BBB AUTO LINE applications can also be requested by calling the Ford Motor Company Customer Relationship Center at 1-800-392-3673.

For additional information, refer to the Better Business Bureau website.

Note: *Ford Motor Company reserves the right to change eligibility limitations, modify procedures, or to discontinue this process at any time without notice and without obligation.*

Customer Assistance

UTILIZING THE MEDIATION/ARBITRATION PROGRAM (CANADA ONLY)

For vehicles delivered to authorized Canadian dealers. In those cases where you continue to feel that the efforts by Ford of Canada and the authorized dealer to resolve a factory-related vehicle service concern have been unsatisfactory, Ford of Canada participates in an impartial third party mediation/arbitration program administered by the Canadian Motor Vehicle Arbitration Plan (CAMVAP).

The CAMVAP program is a straight forward and relatively speedy alternative to resolve a disagreement when all other efforts to produce a settlement have failed. This procedure is without cost to you and is designed to eliminate the need for lengthy and expensive legal proceedings.

In the CAMVAP program, impartial third-party arbitrators conduct hearings at mutually convenient times and places in an informal environment. These impartial arbitrators review the positions of the parties, make decisions and, when appropriate, render awards to resolve disputes. CAMVAP decisions are fast, fair, and final as the arbitrator's award is binding on both you and Ford of Canada.

CAMVAP services are available in all Canadian territories and provinces. For more information, without charge or obligation, call your CAMVAP Provincial Administrator directly at 1-800-207-0685 or visit www.camvap.ca.

GETTING ASSISTANCE OUTSIDE THE U.S. AND CANADA

Before exporting your vehicle to a foreign country, contact the appropriate foreign embassy or consulate. These officials can inform you of local vehicle registration regulations and where to find unleaded fuel or petrol/gas engines or the proper sulfur fuel for diesel engines.

If you cannot find the proper fuel recommended for your vehicle, contact our Customer Relationship Center.

The use of improper fuels in your vehicle without proper conversion may damage the effectiveness of your emission control system and may cause engine knocking or serious engine damage. Ford Motor Company or Ford of Canada is not responsible for any damage caused by use of improper fuel. Using improper fuels may also result in difficulty importing your vehicle back into the United States.

If your vehicle must be serviced while you are traveling or living in Asia-Pacific Region, Sub-Saharan Africa, U.S. Virgin Islands and/or Puerto Rico, Central America, the Caribbean, and Israel and the Middle East, contact the nearest authorized dealer. If the authorized dealer cannot help you, contact the corresponding Ford Customer Assistance Center:

FORD MOTOR COMPANY
Customer Relationship Centers in:

Customer Assistance

Customer Relationship Center	Phone	Fax	E-mail
Asia Pacific	N/A	N/A	apemrc@ford.com
Caribbean and Central America	+1-800-841-3673	N/A	atnclien@ford.com
Middle East	Ford 80004443673	971 4 3327 266	menacac@ford.com
	Lincoln 80004441067		
	UAE 80004441066		
	Saudi Arabia 8008443673		
	Mobily and Zain cell phone users in Saudi 800850078		
	Kuwait 22280384		
North Africa	N/A	N/A	nafcrc@ford.com
Puerto Rico and U.S. Virgin Islands	+1-800-841-3673	N/A	atnclien@ford.com
Sub-Saharan Africa	N/A	N/A	ssacrc@ford.com
South Korea	+82-02-1600-6003	N/A	infokr1@ford.com or infokr@lincoln.com

If you buy your vehicle in North America and then relocate to any of the above locations, register your vehicle identification number (VIN) and new address with Ford Global Trade Services by emailing, expcso@ford.com.

If you are in another foreign country, contact the nearest authorized dealer. In the event your inquiry is unresolved, communicate your concern with the dealership's Sales Manager, Service Manager or Customer Relations Manager. If you require additional assistance or clarification, please contact the respective Customer Relationship Center as previously listed.

Customers in the U.S. should call 1-800-392-3673.

Customer Assistance

ORDERING ADDITIONAL OWNER'S LITERATURE

To order the publications in this portfolio, contact Helm, LLC at:

HELM, LLC
47911 Halyard Drive, Suite 200
Plymouth, Michigan 48170
Attention: Customer Service

Or to order a free publication catalog, call toll free: 1-800-782-4356

Monday-Friday 8:00 a.m. - 6:00 p.m. EST

Helm, LLC can also be reached by their website:

www.helminc.com

(Items in this catalog may be purchased by credit card, check or money order.)

Obtaining a French Owner's Manual

French Owner's Manual can be obtained from your authorized dealer or by contacting Helm, LLC using the contact information listed previously in this section.

REPORTING SAFETY DEFECTS (U.S. ONLY)

If you believe that your vehicle has a defect which could cause a crash or could cause injury or death, you should immediately inform the National Highway Traffic Safety Administration (NHTSA) in addition to notifying Ford Motor Company.

If NHTSA receives similar complaints, it may open an investigation, and if it finds that a safety defect exists in a group of vehicles, it may order a recall and remedy campaign. However, NHTSA cannot become involved in individual problems between you, your dealer, or Ford Motor Company.

To contact NHTSA, you may call the Vehicle Safety Hotline toll-free at 1-888-327-4236 (TTY: 1-800-424-9153); go to www.safercar.gov; or write to:

Administrator

1200 New Jersey Avenue,
Southeast

Washington, D.C. 20590

You can also obtain other information about motor vehicle safety from www.safercar.gov.

REPORTING SAFETY DEFECTS (CANADA ONLY)

If you believe that your vehicle has a defect which could cause a crash or could cause injury or death, you should immediately inform Transport Canada and Ford of Canada.

Customer Assistance

Transport Canada Contact Information	
Website (English)	http://tc.canada.ca/recalls
Website (French)	http://tc.canada.ca/rappels
Phone	1-800-333-0510

Ford of Canada Contact Information	
Website	www.ford.ca
Phone	1-800-565-3673

Fuses

FUSE SPECIFICATION CHART

Engine Compartment Fuse Box



WARNING: Always disconnect the battery before servicing high current fuses.



WARNING: To reduce risk of electrical shock, always replace the cover to the power distribution box before reconnecting the battery or refilling fluid reservoirs.

The engine compartment fuse box is under the driver side leaf screen in the engine compartment. It has high-current fuses that protect your vehicle's main electrical systems from overloads.

If you disconnect and reconnect the battery, you need to reset some features. See **Changing the 12V Battery** (page 329).

Note: Replace fuses with the same type and rating. See **Changing a Fuse** (page 313).

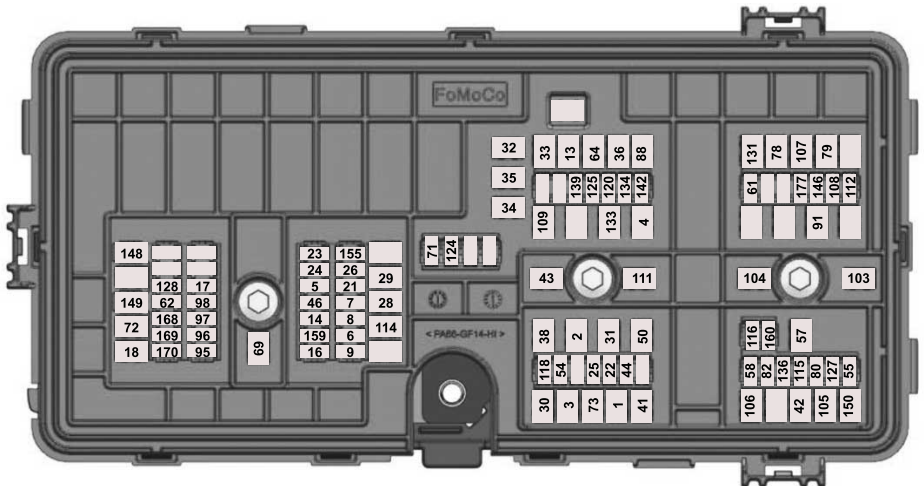

E288347

Fuses

Fuse or Relay Number	Fuse Rating	Protected Component
1	40A	Body control module - battery power in feed 1.
2	20A	Power outlet main console bin.
3	40A	Body control module - battery power in feed 2.
4	30A	Fuel pump.
5	5A	Powertrain control module keep alive power.
6	20A	Powertrain control module power.
7	20A	Canister vent solenoid. Evaporative leak control module. Exhaust gas heat recovery (hybrid electric vehicle). Tank pressure control valve (hybrid electric vehicle). Refueling valve (plug-in hybrid electric vehicle). Vapor blocking valve. Universal exhaust gas oxygen 11. Universal exhaust gas oxygen 21. Catalyst monitor sensor 12. Catalyst monitor sensor 22. Canister purge valve.
8	20A	Cooling fan relay coil. Battery interrupt box. Transmission oil pump. Auxiliary coolant pump. Fuel flap door (hybrid electric vehicle). Engine coolant bypass valve. Active grille shutters.
9	20A	Ignition coils.
13	40A	Front blower motor relay.
14	15A	Transmission oil pump. A/C compressor variable clutch. Auxiliary pumps (hybrid electric vehicle).

Fuses

Fuse or Relay Number	Fuse Rating	Protected Component
16	15A	Windshield and rear window washer pump relay power.
17	5A	Charge status indicator (hybrid electric vehicle).
18	30A	Starter motor.
21	10A	Headlamp leveling motors. Adaptive headlamps.
22	10A	Electric power assisted steering module.
23	10A	Anti-lock brake system module with integrated park brake.
24	10A	Powertrain control module. Hybrid powertrain control module.
25	10A	Air quality sensor. 360 camera with park aid. Rear view camera. Blind spot information system. Adaptive cruise control module.
26	15A	Transmission control module.
28	40A	Anti-lock brake system valves with integrated park brake.
29	60A	Anti-lock brake system pump with integrated park brake.
30	30A	Driver seat module.
31	30A	Passenger seat motor.
32	20A	Front media bin power point.
33	20A	Rear cargo area power point.
34	20A	Console end cap power point.
35	20A	Power point 4.
36	40A	Power inverter.
38	30A	Climate controlled seat module.
41	30A	Power liftgate module.

Fuses

Fuse or Relay Number	Fuse Rating	Protected Component
42	30A	Trailer brake control module.
43	60A	Body control module.
44	10A	Brake on and off switch.
46	15A	Battery charger control module (hybrid electric vehicle).
50	40A	Heated backlite.
54	20A	Heated steering wheel.
55	20A	Trailer tow park lamps.
57	30A	Trailer tow battery charge.
58	10A	Trailer tow backup lamps.
61	15A	Multi-contour seat module.
62	15A	Headlamp washer pump.
64	40A	Four-wheel drive module.
69	30A	Front window wiper motor.
71	15A	Rear window wiper motor.
72	20A	Not used (spare).
73	30A	Driver door module.
78	50A	Left-hand heated windshield.
79	50A	Right-hand heated windshield.
80	20A	Trailer tow.
82	20A	Not used (spare).
88	20A	Rear blower motor.
91	20A	Trailer tow lighting module.
95	15A	Integrated spark control (hybrid electric vehicle).
96	15A	Not used (spare).
97	10A	Electric AC (hybrid electric vehicle).

Fuses

Fuse or Relay Number	Fuse Rating	Protected Component
		High voltage positive temperature coefficient heater (hybrid electric vehicle).
98	10A	Traction battery coolant proportional valve (hybrid electric vehicle).
103	50A	Not used (spare).
104	50A	Not used (spare).
105	40A	Not used (spare).
106	40A	Not used (spare).
107	40A	Not used (spare).
108	20A	Not used (spare).
109	30A	Passenger door module.
111	30A	Body control module voltage quality monitor feed.
112	20A	Not used (spare).
114	50A	Not used (spare).
115	20A	Amplifier.
116	5A	Not used (spare).
118	30A	Second row heated seats.
120	15A	Port fuel injectors.
124	5A	Rain sensor.
125	5A	USB smart charger 1.
127	20A	Amplifier.
128	15A	Not used (spare).
131	40A	Power folding seat module.
133	15A	Heated wiper park.
134	10A	Family entertainment system.
136	20A	Not used (spare).

Fuses

Fuse or Relay Number	Fuse Rating	Protected Component
139	5A	USB smart charger 2.
142	5A	Traffic cam.
146	15A	Battery electronic control module.
148	30A	Left-hand headlamp module.
149	30A	Right-hand headlamp module.
150	40A	Not used (spare).
155	25A	Transmission control module (hybrid electric vehicle).
159	15A	DC/DC converter (hybrid electric vehicle).
160	10A	Not used (spare).
168	20A	Low voltage service disconnect.
169	10A	Coolant pump (hybrid electric vehicle).
170	10A	Traction battery coolant pump (hybrid electric vehicle). Pedestrian sounder (hybrid electric vehicle).
177	10A	Not used (spare).

Note: Spare fuse amperage may vary.

Passenger Compartment Fuse Panel

The fuse panel is under the instrument panel to the left of the steering column.

Note: It may be easier to access the fuse panel if you remove the finish trim piece.

Fuses

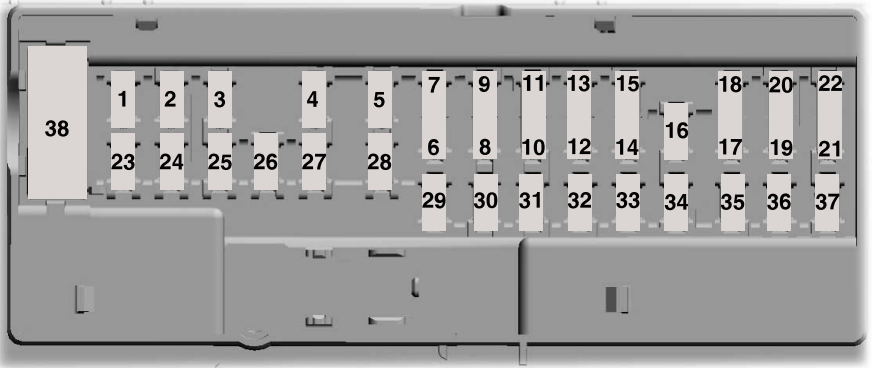

Fuse or Relay Number	Fuse Rating	Protected Component
1	—	Not used.
2	10A	Moonroof. ERA-GLONAS. eCall. Telematics control unit module. Inverter. Driver door switch pack.
3	7.5A	Memory seat switch. Wireless accessory charger module. Seat switches.
4	20A	Not used (spare).
5	—	Not used.
6	10A	Not used.
7	10A	Smart data link connector power.
8	5A	Telematics control unit modem. Hands-free liftgate actuation module. Power liftgate module.
9	5A	Keypad switch.

Fuses

Fuse or Relay Number	Fuse Rating	Protected Component
		Rear climate control.
10	—	Not used.
11	—	Not used.
12	7.5A	Climate control head. Gear shift module.
13	7.5A	Steering column control module. Smart datalink connector. Instrument cluster.
14	15A	Not used (spare).
15	15A	SYNC. Integrated control panel.
16	—	Not used.
17	7.5A	Headlamp control module.
18	7.5A	Not used (spare).
19	5A	Headlamp switch. Push button ignition switch.
20	5A	Ignition switch. Telematics control unit module. Key inhibit solenoid lock.
21	5A	Not used.
22	5A	Not used (spare).
23	30A	Not used (spare).
24	30A	Moonroof.
25	20A	Not used (spare).
26	30A	Not used (spare).
27	30A	Not used (spare).
28	30A	Not used (spare).
29	15A	Not used (spare).
30	5A	Trailer brake connector.

Fuses

Fuse or Relay Number	Fuse Rating	Protected Component
31	10A	Terrain management switch. Selectable drive mode switch. Transceiver module.
32	20A	Audio control module.
33	—	Not used.
34	30A	Run/start relay.
35	5A	Not used (spare).
36	15A	Park assist module. Image processing module A.
37	20A	Not used (spare).
38	30A	Left-hand rear power window. Right-hand rear power window.

Note: Spare fuse amperage may vary.

CHANGING A FUSE

Fuses



WARNING: Always replace a fuse with one that has the specified amperage rating. Using a fuse with a higher amperage rating can cause severe wire damage and could start a fire.

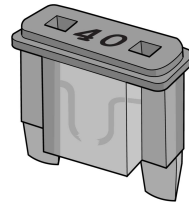

E217331

If electrical components in the vehicle are not working, a fuse may have blown. Blown fuses are identified by a broken wire within the fuse. Check the appropriate fuses before replacing any electrical components.

Fuses

Fuse Types

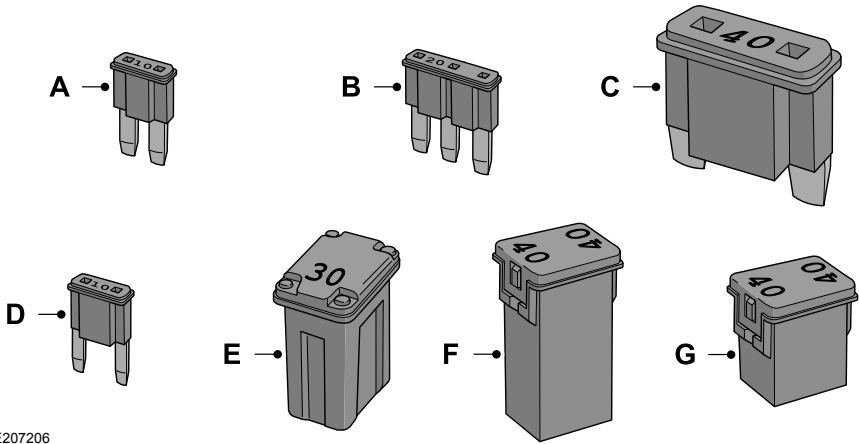

E207206

Callout	Fuse Type
A	Micro 2
B	Micro 3
C	Maxi
D	Mini
E	M Case
F	J Case
G	J Case Low Profile

Maintenance

GENERAL INFORMATION

Have your vehicle serviced regularly to help maintain its roadworthiness and resale value. There is a large network of authorized dealers that are there to help you with their professional servicing expertise. We believe that their specially trained technicians are best qualified to service your vehicle properly and expertly. They are supported by a wide range of highly specialized tools developed specifically for servicing your vehicle.

If your vehicle requires professional service, an authorized dealer can provide the necessary parts and service. Check your warranty information to find out which parts and services are covered.

Use only recommended fuels, lubricants, fluids and service parts conforming to specifications. Motorcraft® parts are designed and built to provide the best performance in your vehicle.

Precautions

- Do not work on a hot engine.
- Make sure that nothing gets caught in moving parts.
- Do not work on a vehicle with the engine running in an enclosed space, unless you are sure you have enough ventilation.
- Keep all open flames and other burning material (such as cigarettes) away from the battery and all fuel related parts.

Working with the Engine Off

1. Set the parking brake and shift the transmission to park (P).
2. Switch off the engine.
3. Block the wheels.

Working with the Engine On

⚠ WARNING: To reduce the risk of vehicle damage and personal burn injuries, do not start your engine with the air cleaner removed and do not remove it while the engine is running.

1. Set the parking brake and shift the transmission to park (P).
2. Block the wheels.

OPENING AND CLOSING THE HOOD

Opening the Hood

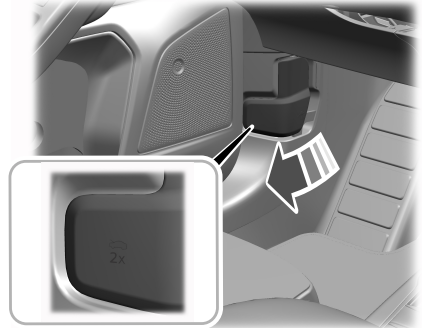

E263274

1. Open the left-hand front door.
2. Fully pull the hood release lever and let it completely retract.

Note: This action releases the hood latch.

3. Fully pull the hood release lever for a second time.

Note: This action fully releases the hood.

4. Open the hood.

Note: There is no secondary latch under the hood.

Maintenance

Closing the Hood



WARNING: Make sure that you fully latch the hood before driving. Failure to follow this instruction could result in personal injury or death.

1. Remove the prop rod from the catch and secure it correctly in the clip.
2. Lower the hood and allow it to drop under its own weight for the last 10–14 in (25–35 cm).

Note: Make sure that the hood is correctly closed.

5. Support the hood with the prop rod.

UNDER HOOD OVERVIEW - 2.3L ECOBOOST™

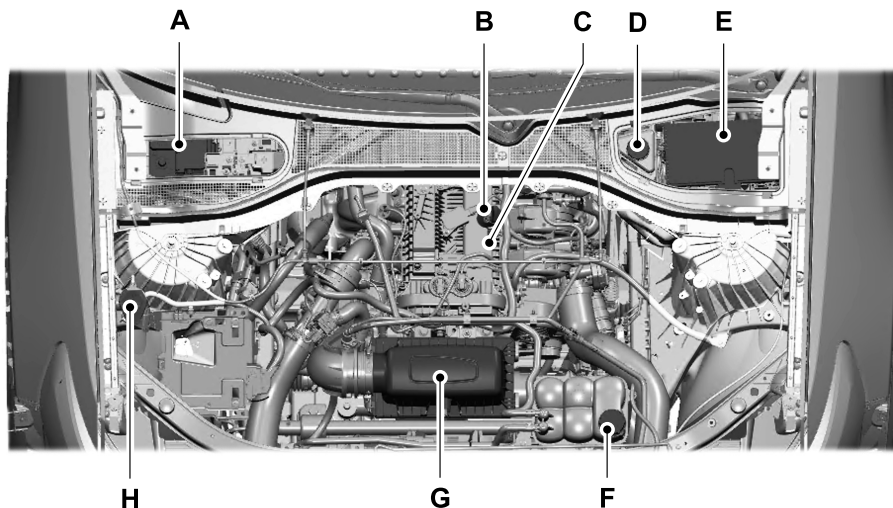

- A Battery. See **Changing the 12V Battery** (page 329).
B Engine oil filler cap. See **Engine Oil Check** (page 319).

Maintenance

- C Engine oil dipstick. See **Engine Oil Dipstick** (page 319).
- D Brake fluid reservoir. See **Brake Fluid Check** (page 328).
- E Engine compartment fuse box. See **Changing a Fuse** (page 313).
- F Engine coolant reservoir. See **Engine Coolant Check** (page 324).
- G Air filter assembly. See **Changing the Engine Air Filter** (page 321).
- H Windshield washer fluid reservoir. See **Washer Fluid Check** (page 336).

UNDER HOOD OVERVIEW - 3.0L

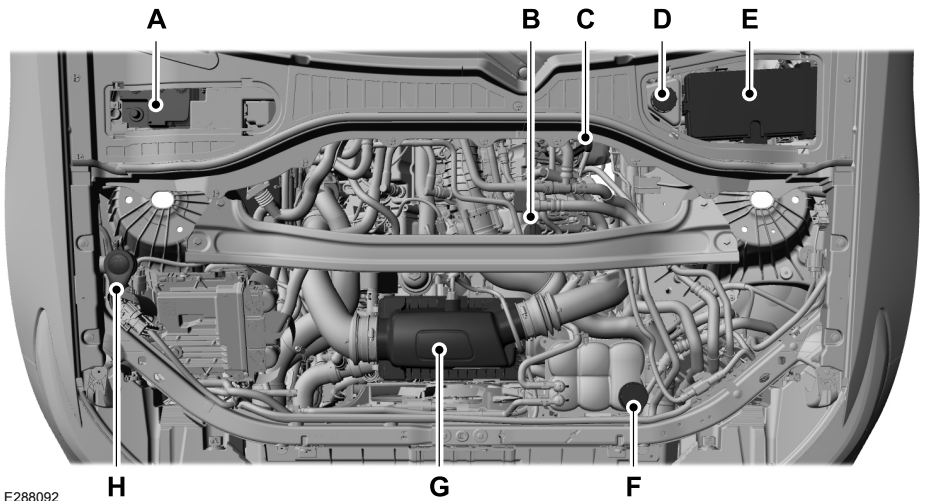

E288092

- A Battery. See **Changing the 12V Battery** (page 329).
- B Engine oil filler cap. See **Engine Oil Check** (page 319).
- C Engine oil dipstick. See **Engine Oil Dipstick** (page 319).
- D Brake fluid reservoir. See **Brake Fluid Check** (page 328).
- E Engine compartment fuse box. See **Fuses** (page 305).
- F Engine coolant reservoir. See **Engine Coolant Check** (page 324).

Maintenance

- G Air filter assembly. See **Changing the Engine Air Filter** (page 322).
- H Washer fluid reservoir. See **Washer Fluid Check** (page 336).

UNDER HOOD OVERVIEW - 3.3L

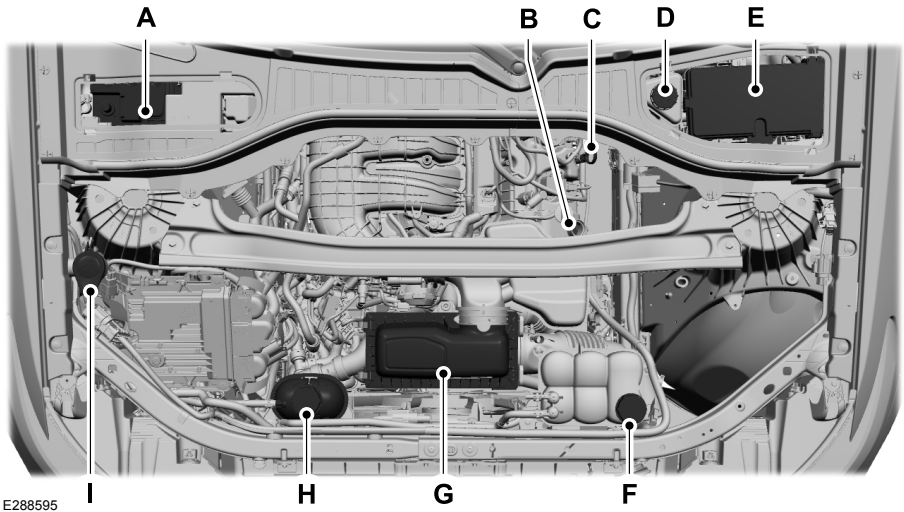

E288595

- A. Battery. See **Changing the 12V Battery** (page 329).
- B. Engine oil filler cap. See **Engine Oil Check** (page 319).
- C. Engine oil dipstick. See **Engine Oil Dipstick** (page 319).
- D. Brake fluid reservoir. See **Brake Fluid Check** (page 328).
- E. Engine compartment fuse box. See **Fuses** (page 305).
- F. Engine coolant reservoir cap. See **Engine Coolant Check** (page 324).
- G. Air filter assembly. See **Changing the Engine Air Filter** (page 321).
- H. Inverter system controller coolant reservoir cap- HEV only.
- I. Washer fluid reservoir. See **Washer Fluid Check** (page 336).

Maintenance

ENGINE OIL DIPSTICK - 2.3L ECOBOOST™

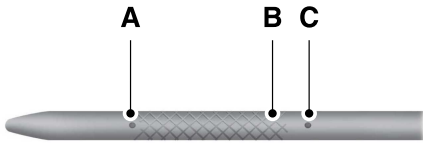

- A Minimum.
- B Nominal.
- C Maximum.

ENGINE OIL DIPSTICK - 3.3L

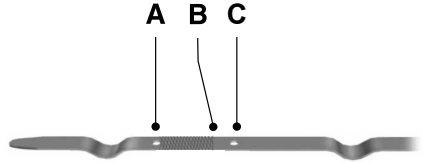

- A Minimum.
- B Nominal.
- C Maximum.

ENGINE OIL DIPSTICK - 3.0L

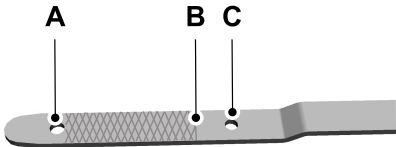

- A Minimum.
- B Nominal.
- C Maximum.

ENGINE OIL CHECK

1. Make sure that your vehicle is on level ground.
2. Check the oil level before starting the engine, or switch the engine off after warm up and wait 15 minutes for the oil to drain into the oil pan.

Note: *Checking the oil level too soon could result in an inaccurate reading.*

3. Remove the dipstick and wipe it with a clean, lint-free cloth.
4. Reinstall the dipstick and make sure it is fully seated.
5. Remove the dipstick again to check the oil level.

Note: *If the oil level is between the maximum and minimum marks, the oil level is acceptable. Do not add oil.*

6. If the oil level is at the minimum mark, immediately add oil.
7. Reinstall the dipstick. Make sure it is fully seated.

Maintenance

Note: The oil consumption of new engines reaches its normal level after approximately 3,000 mi (5,000 km).

Note: Increases in oil level can occur from frequent short trips that do not allow the engine to get to operating temperature, as well as frequent idling or low speed driving for long periods of time.

Note: If oil levels are continuously noted above the maximum mark, schedule a visit to your authorized dealer.

Adding Engine Oil

 **WARNING:** Do not add engine oil when the engine is hot. Failure to follow this instruction could result in personal injury.

 **WARNING:** Do not remove the filler cap when the engine is running.

Do not use supplemental engine oil additives because they are unnecessary and could lead to engine damage that the vehicle warranty may not cover.

1. Clean the area surrounding the engine oil filler cap before you remove it.
2. Remove the engine oil filler cap.
3. Add engine oil that meets our specifications. See **Capacities and Specifications** (page 384).
4. Reinstall the engine oil filler cap. Turn it clockwise until you feel a strong resistance.

Note: Make sure you install the oil filler cap correctly.

Note: Do not add oil further than the maximum mark. Oil levels above the maximum mark may cause engine damage.

Note: Immediately soak up any oil spillage with an absorbent cloth.

OIL CHANGE INDICATOR RESET

Use the information display controls on the steering wheel to reset the oil change indicator.

From the main menu scroll to:

Message	Action and description
Settings	Press the right arrow button, then from this menu scroll to the following message.
Vehicle	Press the right arrow button, then from this menu scroll to the following message.
Hold OK to Reset	Press and hold the OK button until the instrument cluster displays the following message. Reset Successful
	When the oil change indicator resets the instrument cluster displays 100%. Remaining Life {00}%
	If the instrument cluster displays one of the following messages, repeat the process. Not Reset Reset Cancelled

Maintenance

CHANGING THE ENGINE AIR FILTER - 2.3L ECOBOOST™



WARNING: To reduce the risk of vehicle damage and personal burn injuries, do not start your engine with the air cleaner removed and do not remove it while the engine is running.

When changing the engine air filter, do not allow debris or foreign material to enter the air induction system. Engine components are susceptible to damage not covered by the vehicle Warranty.

Change the air filter element at the correct interval. See **Scheduled Maintenance** (page 476).

Incorrect component use can cause damage not covered by the vehicle Warranty. See **Motorcraft Parts** (page 382).

To replace the air filter element do the following:

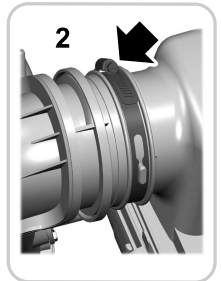
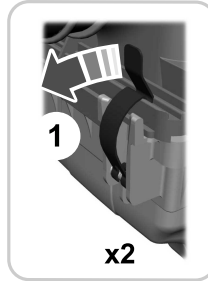
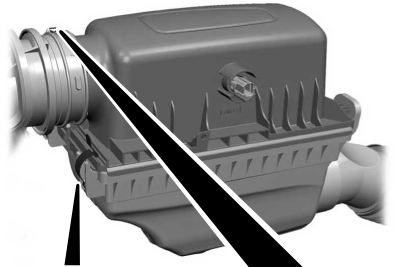

1. Remove the clips that secure the air filter housing cover.
2. Using a screwdriver, loosen the clamp on air filter housing cover.
3. Gently pull the boot back away from the air filter housing cover.
4. Carefully lift the air filter housing cover from the air filter housing assembly.
5. Remove the air filter element from the air filter housing.
6. Wipe any dirt or debris from the air filter housing and cover to make sure no dirt gets in the engine and that you have a good seal.

Maintenance

7. Install a new air filter element. Be careful not to crimp the filter element edges between the air filter housing and cover. This could cause filter damage and allow unfiltered air to enter the engine if it is not properly seated.
8. Install the air filter housing cover.
9. Engage the clips to secure the air filter housing cover to the air filter housing.
10. Reconnect the boot to the air filter housing cover and torque to 3.69 lb.ft (5 Nm).

CHANGING THE ENGINE AIR FILTER - 3.0L



WARNING: To reduce the risk of vehicle damage and personal burn injuries, do not start your engine with the air cleaner removed and do not remove it while the engine is running.

When changing the engine air filter, do not allow debris or foreign material to enter the air induction system. Engine components are susceptible to damage not covered by the vehicle Warranty.

Change the air filter element at the correct interval. See **Scheduled Maintenance** (page 476).

Incorrect component use can cause damage not covered by the vehicle Warranty. See **Motorcraft Parts** (page 382).

To replace the air filter element do the following:

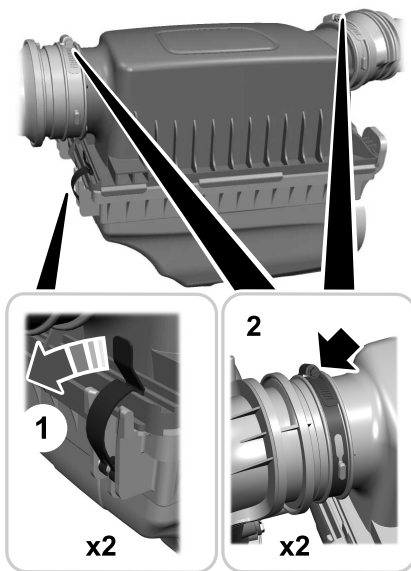

1. Remove the clips that secure the air filter housing cover.
2. Using a screwdriver, loosen two clamps on either side of the air filter housing cover.
3. Gently pull the two boots back away from the air filter housing cover.
4. Carefully lift the air filter housing cover.
5. Remove the air filter element from the air filter housing.
6. Wipe any dirt or debris from the air filter housing and cover to make sure no dirt gets in the engine and that you have a good seal.

Maintenance

7. Install a new air filter element. Be careful not to crimp the filter element edges between the air filter housing and cover. This could cause filter damage and allow unfiltered air to enter the engine if it is not properly seated.
8. Install the air filter housing cover.
9. Engage the clips to secure the air filter housing cover to the air filter housing.
10. Reconnect the two boots on the air filter housing cover and torque to 3.69 lb.ft (5 Nm).

CHANGING THE ENGINE AIR FILTER - 3.3L



WARNING: To reduce the risk of vehicle damage and personal burn injuries, do not start your engine with the air cleaner removed and do not remove it while the engine is running.

Note: Failure to use the correct air filter element may result in severe engine damage. Resulting component damage may not be covered by the vehicle Warranty.

Note: When servicing the air cleaner, do not allow foreign material to enter the air induction system. The engine is susceptible to damage from even small particles.

When changing the air filter element, use only the air filter element listed.

Change the air filter element at the proper intervals. See **Scheduled Maintenance** (page 476).

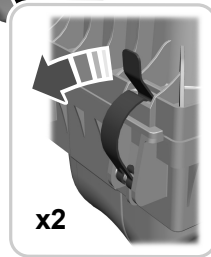
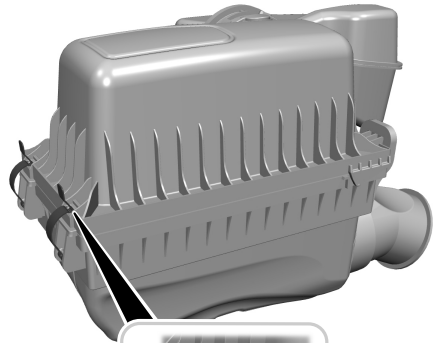



1. Release the clamps that secure the air filter cover to the housing.
2. Using a screwdriver, loosen the clamp on the air filter housing cover.
3. Gently pull the boot back away from the air filter housing cover.
4. Carefully lift the air filter housing cover.
5. Remove the air filter element from the air filter housing.
6. Wipe any dirt or debris from the air filter housing and cover to make sure no dirt gets in the engine and that you have a good seal.
7. Install a new air filter element. Be careful not to crimp the filter element edges between the air filter housing and cover. This could cause filter damage and allow unfiltered air to enter the engine if it is not properly seated.

Maintenance

8. Install the air filter housing cover.
9. Engage the clips to secure the air filter housing cover to the air filter housing.
10. Reconnect the boot to the air filter housing cover and torque to 3.69 lb.ft (5 Nm).

ENGINE COOLANT CHECK

 **WARNING:** Do not remove the coolant reservoir cap when the engine is on or the cooling system is hot. Wait 10 minutes for the cooling system to cool down. Cover the coolant reservoir cap with a thick cloth to prevent the possibility of scalding and slowly remove the cap. Failure to follow this instruction could result in personal injury.

 **WARNING:** Do not put coolant in the windshield washer reservoir. If sprayed on the windshield, coolant could make it difficult to see through the windshield.

 **WARNING:** To reduce the risk of personal injury, make sure the engine is cool before unscrewing the coolant pressure relief cap. The cooling system is under pressure. Steam and hot liquid can come out forcefully when you loosen the cap slightly.

When the engine is cold, check the concentration and level of the coolant at the intervals listed in the scheduled maintenance information. See **Scheduled Maintenance** (page 476).

Note: Make sure that the coolant level is between the **MIN** and the **MAX** marks on the coolant reservoir.

Note: Coolant expands when it is hot. The level may extend beyond the **MAX** mark.

Maintain coolant concentration within 48% to 50%, which equates to a freeze point between -29°F (-34°C) and -35°F (-37°C). Coolant concentration should be checked using a refractometer. We do not recommend the use of hydrometers or coolant test strips for measuring coolant concentration.

Adding Coolant

 **WARNING:** Do not add coolant further than the **MAX** mark.

 **WARNING:** Do not add coolant when the vehicle is on or the cooling system is hot. Failure to follow this instruction could result in personal injury.

 **WARNING:** Do not remove the coolant reservoir cap when the engine is on or the cooling system is hot. Wait 10 minutes for the cooling system to cool down. Cover the coolant reservoir cap with a thick cloth to prevent the possibility of scalding and slowly remove the cap. Failure to follow this instruction could result in personal injury.

 **WARNING:** Do not put coolant in the windshield washer reservoir. If sprayed on the windshield, coolant could make it difficult to see through the windshield.

Note: Do not use stop leak pellets, cooling system sealants, or non-specified additives as they can cause damage to the engine cooling or heating systems. Resulting component damage may not be covered by the vehicle Warranty.

Note: Automotive fluids are not interchangeable.

Maintenance

It is very important to use prediluted coolant approved to the correct specification in order to avoid plugging the small passageways in the engine cooling system. See **Capacities and Specifications** (page 378). Do not mix different colors or types of coolant in your vehicle. Mixing of engine coolants or using an incorrect coolant may harm the engine or cooling system components and may not be covered by the vehicle Warranty.

Note: *If prediluted coolant is not available, use the approved concentrated coolant diluting it to 50/50 with distilled water. See **Capacities and Specifications** (page 378). Using water that has not been deionised may contribute to deposit formation, corrosion and plugging of the small cooling system passageways.*

Note: *Coolants marketed for all makes and models may not be approved to our specifications and may cause damage to the cooling system. Resulting component damage may not be covered by the vehicle Warranty.*

If the coolant level is at or below the minimum mark, add prediluted coolant immediately.

To top up the coolant level do the following:

1. Unscrew the cap slowly. Any pressure escapes as you unscrew the cap.
2. Add prediluted coolant approved to the correct specification. See **Capacities and Specifications** (page 378).
3. Add enough prediluted coolant to reach the correct level.
4. Replace the coolant reservoir cap. Turn the cap clockwise until it contacts the hard stop.

5. Check the coolant level in the coolant reservoir the next few times you drive your vehicle. If necessary, add enough prediluted engine coolant to bring the coolant level to the correct level.

If you have to add more than 1.1 qt (1 L) of engine coolant per month, have your vehicle checked as soon as possible. Operating an engine with a low level of coolant can result in engine overheating and possible engine damage.

In case of emergency, you can add a large amount of water without engine coolant in order to reach a vehicle service location. In this instance, qualified personnel:

1. Must drain the cooling system.
2. Chemically clean the coolant system.
3. Refill with engine coolant as soon as possible.

Water alone, without engine coolant, can cause engine damage from corrosion, overheating or freezing.

Do not use the following as a coolant substitute:

- Alcohol.
- Methanol.
- Brine.
- Any coolant mixed with alcohol or methanol antifreeze.

Alcohol and other liquids can cause engine damage from overheating or freezing.

Do not add extra inhibitors or additives to the coolant. These can be harmful and compromise the corrosion protection of the coolant.

Recycled Coolant

We do not recommend the use of recycled coolant as an approved recycling process is not yet available.

Note: *Dispose of used coolant in the appropriate manner.*

Maintenance

Follow your community's regulations and standards for recycling and disposing of automotive fluids.

Severe Climates

If you drive in extremely cold climates:

- It may be necessary to increase the coolant concentration above 50%.
- A coolant concentration of 60% provides improved freeze point protection.
- Coolant concentrations above 60% decrease the overheat protection characteristics of the coolant and may cause engine damage.

If you drive in extremely hot climates:

- You can decrease the coolant concentration to 40%.
- A coolant concentration of 40% provides improved overheat protection.
- Coolant concentrations below 40% decrease the overheat and corrosion protection characteristics of the coolant and may cause engine damage.

Vehicles driven year-round in non-extreme climates should use prediluted coolant for optimum cooling system and engine protection.

Coolant Change

At specific mileage intervals, as listed in the scheduled maintenance information, the coolant should be changed. Add prediluted coolant approved to the correct specification. See **Capacities and Specifications** (page 378).

Fail-Safe Cooling

Fail-safe cooling allows you to temporarily drive your vehicle before any incremental component damage occurs. The fail-safe distance depends on ambient temperature, vehicle load and terrain.

How Fail-Safe Cooling Works



If the engine begins to overheat, the coolant temperature gauge moves toward the red zone:



A warning lamp illuminates and a message may appear in the information display.

If the engine reaches a preset over-temperature condition, the engine automatically switches to alternating cylinder operation. Each disabled cylinder acts as an air pump and cools the engine.

When this occurs, your vehicle still operates, however:

- Engine power is limited.
- The air conditioning system turns off.

Continued operation increases the engine temperature, causing the engine to completely shut down. Your steering and braking effort increases in this situation.

When the engine temperature cools, you can re-start the engine. Have your vehicle checked as soon as possible to minimize engine damage.

When Fail-Safe Mode Is Activated



WARNING: Fail-safe mode is for use during emergencies only. Operate your vehicle in fail-safe mode only as long as necessary to bring your vehicle to rest in a safe location and seek immediate repairs. When in fail-safe mode, your vehicle will have limited power, will not be able to maintain

Maintenance

high-speed operation, and may completely shut down without warning, potentially losing engine power, power steering assist, and power brake assist, which may increase the possibility of a crash resulting in serious injury.



WARNING: Do not remove the coolant reservoir cap when the engine is on or the cooling system is hot. Wait 10 minutes for the cooling system to cool down. Cover the coolant reservoir cap with a thick cloth to prevent the possibility of scalding and slowly remove the cap. Failure to follow this instruction could result in personal injury.

Your vehicle has limited engine power when in the fail-safe mode, drive your vehicle with caution. Your vehicle does not maintain high-speed operation and the engine may operate poorly.

Remember that the engine is capable of automatically shutting down to prevent engine damage. In this situation:

1. Pull off the road as soon as safely possible and switch the engine off.
2. If you are a member of a roadside assistance program, we recommend that you contact your roadside assistance service provider.
3. If this is not possible, wait for a short period of time for the engine to cool.
4. Check the coolant level. If the coolant level is at or below the minimum mark, add prediluted coolant immediately.
5. When the engine temperature cools, you can re-start the engine. Have your vehicle checked as soon as possible to minimize engine damage.

Note: *Driving your vehicle without repair increases the chance of engine damage.*

Engine Coolant Temperature Management (If Equipped)



WARNING: To reduce the risk of crash and injury, be prepared that the vehicle speed may reduce and the vehicle may not be able to accelerate with full power until the coolant temperature reduces.

If you tow a trailer with your vehicle, the engine may temporarily reach a higher temperature during severe operating conditions, for example ascending a long or steep grade in high ambient temperatures.

At this time, you may notice the coolant temperature gauge moves toward the red zone and a message may appear in the information display.

You may notice a reduction in vehicle speed caused by reduced engine power in order to manage the engine coolant temperature. Your vehicle may enter this mode if certain high-temperature and high-load conditions take place. The amount of speed reduction depends on vehicle loading, grade and ambient temperature. If this occurs, there is no need to stop your vehicle. You can continue to drive.

The air conditioning may automatically turn on and off during severe operating conditions to protect the engine from overheating. When the coolant temperature decreases to the normal operating temperature, the air conditioning turns on.

If the coolant temperature gauge moves fully into the red zone, or if the coolant temperature warning or service engine soon messages appear in your information display, do the following:

Maintenance

1. Stop your vehicle as soon as it is safe to do so. Fully apply the parking brake, shift into park (P) or neutral (N).
2. Leave the engine running until the coolant temperature gauge needle returns to the normal position. If the temperature does not drop after several minutes, follow the remaining steps.
3. Switch the engine off and wait for it to cool. Check the coolant level.
4. If the coolant level is at or below the minimum mark, add prediluted coolant immediately.
5. If the coolant level is normal, restart the engine and continue.

AUTOMATIC TRANSMISSION FLUID CHECK

If required, have an authorized dealer check and change the transmission fluid at the correct service interval. See **Scheduled Maintenance** (page 476).

The automatic transmission does not have a transmission fluid dipstick.

Refer to your scheduled maintenance information for scheduled intervals for fluid checks and changes. Your transmission does not consume fluid. However, if the transmission slips, shifts slowly or if you notice a sign of leaking fluid, contact an authorized dealer.

Do not use supplemental transmission fluid additives, treatments or cleaning agents. The use of these materials may affect transmission operation and result in damage to internal transmission components.

BRAKE FLUID CHECK



WARNING: Do not use any fluid other than the recommended brake fluid as this will reduce brake efficiency. Use of incorrect fluid could result in the loss of vehicle control, serious personal injury or death.



WARNING: Only use brake fluid from a sealed container. Contamination with dirt, water, petroleum products or other materials may result in brake system damage or failure. Failure to adhere to this warning could result in the loss of vehicle control, serious personal injury or death.



WARNING: Do not allow the fluid to touch your skin or eyes. If this happens, rinse the affected areas immediately with plenty of water and contact your physician.



WARNING: The brake system could be affected if the brake fluid level is below the **MIN** mark or above the **MAX** mark on the brake fluid reservoir.

Maintenance



1. Park your vehicle on a level surface.
2. Look at the brake fluid reservoir to see where the brake fluid level is relative to the **MIN** and the **MAX** marks on the reservoir.

Note: If the brake fluid level is between the **MIN** and the **MAX** marks on the reservoir, it is acceptable.

Note: If the brake fluid level is below the **MIN** mark or above the **MAX** mark, have your vehicle checked as soon as possible.

Note: To avoid fluid contamination, the reservoir cap must remain in place and fully tight, unless you are adding fluid.

Only use fluid that meets our specifications. See **Capacities and Specifications** (page 378).

Brake Fluid Service Interval

Brake fluid absorbs water over time which degrades the effectiveness of the brake fluid. Change the brake fluid at the specified intervals to prevent degraded braking performance.

For detailed interval information, see Scheduled Maintenance in your Owner's Manual or your local maintenance guide.

POWER STEERING FLUID CHECK

Your vehicle is equipped with an electric power steering (EPS) system. There is no fluid reservoir to check or fill.

CHANGING THE 12V BATTERY - EXCLUDING: HYBRID ELECTRIC VEHICLE (HEV)



WARNING: Batteries normally produce explosive gases which can cause personal injury. Therefore, do not allow flames, sparks or lighted substances to come near the battery. When working near the battery, always shield your face and protect your eyes. Always provide correct ventilation.



WARNING: When lifting a plastic-cased battery, excessive pressure on the end walls could cause acid to flow through the vent caps, resulting in personal injury and damage to the vehicle or battery. Lift the battery with a battery carrier or with your hands on opposite corners.



WARNING: Keep batteries out of reach of children. Batteries contain sulfuric acid. Avoid contact with skin, eyes or clothing. Shield your eyes when working near the battery to protect against possible splashing of acid solution. In case of acid contact with skin or eyes, flush immediately with water for a minimum of 15 minutes and get prompt medical attention. If acid is swallowed, call a physician immediately.

Maintenance



WARNING: Battery posts, terminals and related accessories contain lead and lead compounds, chemicals known to the State of California to cause cancer and reproductive harm. **Wash your hands after handling.**



WARNING: This vehicle may have more than one battery. Removing the battery cables from only one battery does not disconnect your vehicle electrical system. Make sure you disconnect the battery cables from all batteries when disconnecting power. Failure to do so may cause serious personal injury or property damage.



WARNING: For vehicles with Auto-Start-Stop the battery requirement is different. You must replace the battery with one of exactly the same specification.

The battery is in the engine compartment. See **Under Hood Overview** (page 317).

Your vehicle has a maintenance-free battery. It does not require additional water during service.

If the vehicle battery has a cover and vent hose, make sure you correctly install it after cleaning or replacing the battery.

For longer, trouble-free operation, keep the top of the battery clean and dry and the battery cables tightly fastened to the battery terminals. If any corrosion is present on the battery or terminals, remove the cables from the terminals and clean with a wire brush. You can neutralize the acid with a solution of baking soda and water.

We recommend that you disconnect the negative battery cable terminal from the battery if you plan to store your vehicle for an extended period.

Note: If you only disconnect the negative battery cable terminal, make sure it is isolated or placed away from the battery terminal to avoid unintended connection or arcing.

If you replace the battery make sure it matches the electrical requirements of your vehicle.

If you disconnect or replace the battery and your vehicle has an automatic transmission, it must relearn its adaptive strategy. Because of this, the transmission may shift firmly when first driven. This is normal operation while the transmission fully updates its operation to optimum shift feel.

Battery Sensor Reset

When you install a new battery, reset the battery sensor by doing the following:

1. Switch the ignition on, and leave the engine off.

Note: Complete Steps 2 and 3 within 10 seconds.

2. Flash the high beam headlamps five times, ending with the high beams off.
3. Press and release the brake pedal three times.

The battery warning lamp flashes three times to confirm that the reset is successful.

Battery Management System (if Equipped)

The system monitors battery conditions and takes actions to extend battery life. If excessive battery drain is detected, the system temporarily disables some electrical systems to protect the battery.

Systems included are:

- Heated rear window.
- Heated seats.

Maintenance

- Climate control.
- Heated steering wheel.
- Audio unit.
- Navigation system.

A message may appear in the information display to alert you that battery protection actions are active. This message is only for notification that an action is taking place, and not intended to indicate an electrical problem or that the battery requires replacement.

After battery replacement, or in some cases after charging the battery with an external charger, the battery management system requires eight hours of vehicle sleep time to relearn the battery state of charge. During this time, your vehicle must remain fully locked with the ignition switched off.

Note: *Prior to relearning the battery state of charge, the battery management system may temporarily disable some electrical systems.*

Electrical Accessory Installation

To make sure the battery management system works correctly, do not connect an electrical device ground connection directly to the battery negative post. This can cause inaccurate measurements of the battery condition and potential incorrect system operation.

Note: *If you add electrical accessories or components to the vehicle, it may adversely affect battery performance and durability. This may also affect the performance of other electrical systems in the vehicle.*

Remove and Reinstall the Battery

Install a battery approved for use by our specifications. See **Capacities and Specifications** (page 378).

To disconnect or remove the battery, do the following:

1. Apply the parking brake and switch the ignition off.
2. Switch all electrical equipment off, for example lights and radio.
3. Wait a minimum of two minutes before disconnecting the battery.

Note: *The engine management system has a power hold function and remains powered for a period of time after you switch the ignition off. This is to allow the system to store diagnostic and adaptive tables. Disconnecting the battery without waiting can cause damage not covered by the vehicle warranty.*

4. Disconnect the negative battery cable terminal.
5. Disconnect the positive battery cable terminal.
6. Remove the battery securing clamp.
7. Remove the battery.
8. To install, reverse the removal procedure.

Note: *Before reconnecting the battery, make sure the ignition remains switched off.*

Note: *Make sure to fully tighten the battery cables.*

If you disconnect or replace the vehicle battery, you must reset the following features:

- Window bounce-back. See **Power Windows** (page 94).
- Clock Settings.
- Pre-set radio stations.

Battery Disposal





Make sure that you dispose of old batteries in an environmentally friendly way. Seek advice from your local authority about recycling old batteries.

Maintenance

CHANGING THE 12V BATTERY - HYBRID ELECTRIC VEHICLE (HEV)

 **WARNING:** Batteries normally produce explosive gases which can cause personal injury. Therefore, do not allow flames, sparks or lighted substances to come near the battery. When working near the battery, always shield your face and protect your eyes. Always provide correct ventilation.

 **WARNING:** When lifting a plastic-cased battery, excessive pressure on the end walls could cause acid to flow through the vent caps, resulting in personal injury and damage to the vehicle or battery. Lift the battery with a battery carrier or with your hands on opposite corners.

 **WARNING:** Keep batteries out of reach of children. Batteries contain sulfuric acid. Avoid contact with skin, eyes or clothing. Shield your eyes when working near the battery to protect against possible splashing of acid solution. In case of acid contact with skin or eyes, flush immediately with water for a minimum of 15 minutes and get prompt medical attention. If acid is swallowed, call a physician immediately.

 **WARNING:** Battery posts, terminals and related accessories contain lead and lead compounds, chemicals known to the State of California to cause cancer and reproductive harm. **Wash your hands after handling.**

 **WARNING:** This vehicle may have more than one battery. Removing the battery cables from only one battery does not disconnect your vehicle electrical system. Make sure you disconnect the battery cables from all batteries when disconnecting power. Failure to do so may cause serious personal injury or property damage.

 **WARNING:** For vehicles with Auto-Start-Stop the battery requirement is different. You must replace the battery with one of exactly the same specification.

The primary battery is in the engine compartment. See **Under Hood Overview** (page 317).

The secondary battery is located behind the trim panel in the luggage compartment.

Maintenance

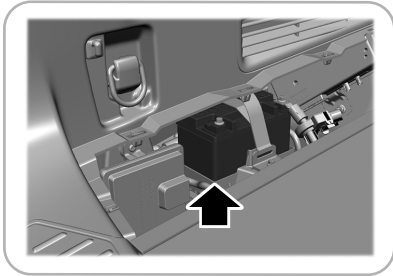
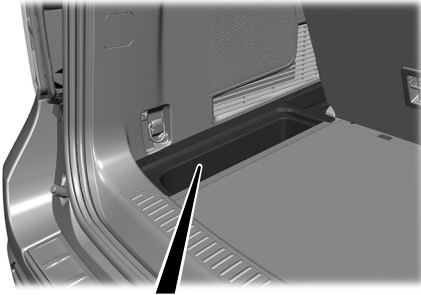

Your vehicle has a maintenance-free battery. It does not require additional water during service.

If the vehicle battery has a cover and vent hose, make sure you correctly install it after cleaning or replacing the battery.

For longer, trouble-free operation, keep the top of the battery clean and dry and the battery cables tightly fastened to the battery terminals. If any corrosion is present on the battery or terminals, remove the cables from the terminals and clean with a wire brush. You can neutralize the acid with a solution of baking soda and water.

We recommend that you disconnect the negative battery cable terminal from the battery if you plan to store your vehicle for an extended period.

Note: If you only disconnect the negative battery cable terminal, make sure it is isolated or placed away from the battery terminal to avoid unintended connection or arcing.

If you replace the battery make sure it matches the electrical requirements of your vehicle.

If you disconnect or replace the battery and your vehicle has an automatic transmission, it must relearn its adaptive strategy. Because of this, the transmission may shift firmly when first driven. This is normal operation while the transmission fully updates its operation to optimum shift feel.

Battery Sensor Reset

When you install a new battery, reset the battery sensor by doing the following:

1. Switch the ignition on, and leave the engine off.

Note: Complete Steps 2 and 3 within 10 seconds.

2. Flash the high beam headlamps five times, ending with the high beams off.
3. Press and release the brake pedal three times.

The battery warning lamp flashes three times to confirm that the reset is successful.

Battery Management System (if Equipped)

The system monitors battery conditions and takes actions to extend battery life. If excessive battery drain is detected, the system temporarily disables some electrical systems to protect the battery.

Systems included are:

- Heated rear window.
- Heated seats.

Maintenance

- Climate control.
- Heated steering wheel.
- Audio unit.
- Navigation system.

A message may appear in the information display to alert you that battery protection actions are active. This message is only for notification that an action is taking place, and not intended to indicate an electrical problem or that the battery requires replacement.

After battery replacement, or in some cases after charging the battery with an external charger, the battery management system requires eight hours of vehicle sleep time to relearn the battery state of charge. During this time, your vehicle must remain fully locked with the ignition switched off.

Note: *Prior to relearning the battery state of charge, the battery management system may temporarily disable some electrical systems.*

Electrical Accessory Installation

To make sure the battery management system works correctly, do not connect an electrical device ground connection directly to the battery negative post. This can cause inaccurate measurements of the battery condition and potential incorrect system operation.

Note: *If you add electrical accessories or components to the vehicle, it may adversely affect battery performance and durability. This may also affect the performance of other electrical systems in the vehicle.*

Remove and Reinstall the Battery

Install a battery approved for use by our specifications. See **Capacities and Specifications** (page 378).

To disconnect or remove the battery, do the following:

1. Apply the parking brake and switch the ignition off.
2. Switch all electrical equipment off, for example lights and radio.
3. Wait a minimum of two minutes before disconnecting the battery.

Note: *The engine management system has a power hold function and remains powered for a period of time after you switch the ignition off. This is to allow the system to store diagnostic and adaptive tables. Disconnecting the battery without waiting can cause damage not covered by the vehicle warranty.*

4. Disconnect the negative battery cable terminal.
5. Disconnect the positive battery cable terminal.
6. Remove the battery securing clamp.
7. Remove the battery.
8. To install, reverse the removal procedure.

Note: *Before reconnecting the battery, make sure the ignition remains switched off.*

Note: *Make sure to fully tighten the battery cables.*

If you disconnect or replace the vehicle battery, you must reset the following features:

- Window bounce-back. See **Power Windows** (page 94).
- Clock Settings.
- Pre-set radio stations.

Battery Disposal



Make sure that you dispose of old batteries in an environmentally friendly way. Seek advice from your local authority about recycling old batteries.

Maintenance

ADJUSTING THE HEADLAMPS

Vertical Aim Adjustment

If your vehicle has been involved in a crash, have the aim of the headlamp beam checked by an authorized dealer.

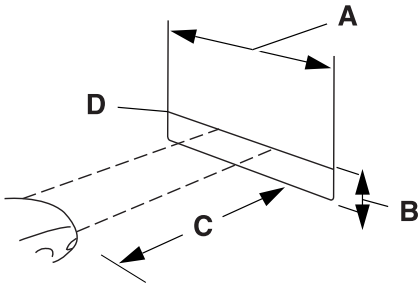

- A 8 ft (2.4 m)
- B Ground to the center of the headlamp high beam bulb
- C 25 ft (7.6 m)
- D Horizontal reference line

Vertical Aim Adjustment Procedure

1. Park your vehicle on level ground approximately 25 ft (7.6 m) from a wall or screen.
2. Measure the distance from the ground to the center of the headlamp beam bulb and mark an 8 ft (2.4 m) long horizontal reference line on the wall or screen at this height.

Note: There may be an identifying mark on the lens to help you locate the center line of the headlamp beam bulb.

Note: To see a clearer light pattern for adjusting, you may want to block the light from one headlamp while adjusting the other.

3. Switch on the low beam headlamps and open the hood.



4. On the wall or screen you will observe a flat zone of high intensity light located at the top of the beam pattern. If the top edge of the flat zone of high intensity light is not on the horizontal reference line, adjust the aim of the headlamp beam.

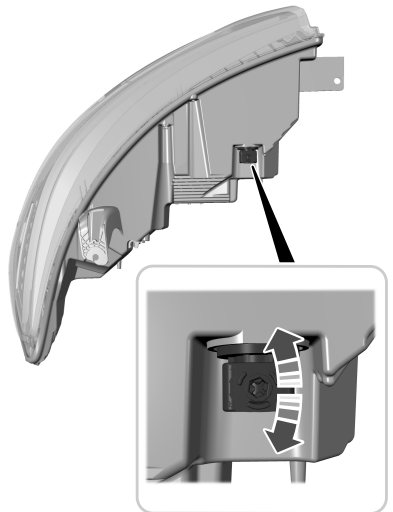

E292172

Maintenance

5. Use a suitable tool, for example a screwdriver or socket wrench, to turn the adjuster clockwise or counterclockwise to adjust the vertical aim of the headlamp. The horizontal edge of the brighter light should touch the horizontal reference line.
6. Close the hood and switch off the lamps.

WASHER FLUID CHECK



WARNING: If you operate your vehicle in temperatures below 41.0°F (5°C), use washer fluid with antifreeze protection. Failure to use washer fluid with antifreeze protection in cold weather could result in impaired windshield vision and increase the risk of injury or accident.

Note: *The front and rear washer systems are supplied from the same reservoir.*

Add fluid to fill the reservoir if the level is low. Only use a washer fluid that meets our specifications. See **Capacities and Specifications** (page 378).

State or local regulations on volatile organic compounds may restrict the use of methanol, a common windshield washer antifreeze additive. Washer fluids containing non-methanol antifreeze agents should be used only if they provide cold weather protection without damaging the vehicle's paint finish, wiper blades or washer system.

FUEL FILTER

Your vehicle is equipped with a lifetime fuel filter that is integrated with the fuel tank. Regular maintenance or replacement is not needed.

CHECKING THE WIPER BLADES



Run the tip of your fingers over the edge of the blade to check for roughness.

Clean the wiper blades with washer fluid or water applied with a soft sponge or cloth.

CHANGING THE FRONT WIPER BLADES

You can improve poor wiper quality by cleaning the wiper blades and the windshield.

Replace the wiper blades at least annually for optimum performance.

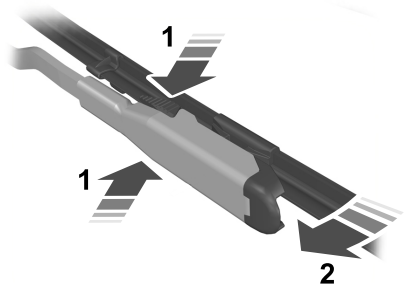

1. Lift the wiper arm and then press the wiper blade locking buttons together.

Note: *Do not hold the wiper blade to lift the wiper arm.*

Maintenance

Note: Make sure that the wiper arm does not spring back against the glass when the wiper blade is not attached.

2. Slightly rotate the wiper blade.
3. Remove the wiper blade.
4. To install, reverse the removal procedure.

Note: Make sure that the wiper blade locks into place.

CHANGING THE REAR WIPER BLADES

You can improve poor wiper quality by cleaning the wiper blades and the windshield.

Replace the wiper blades at least annually for optimum performance.

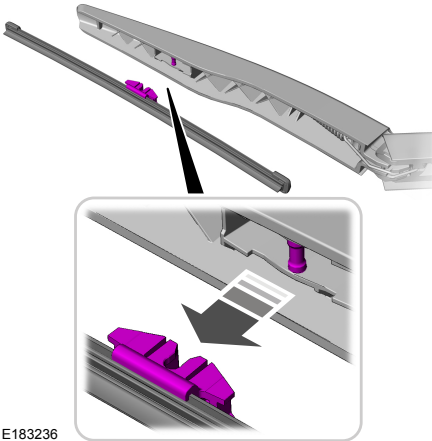

1. Lift the wiper arm.

Note: Do not hold the wiper blade to lift the wiper arm.

2. Remove the wiper blade.

Note: Make sure that the wiper arm does not spring back against the glass when the wiper blade is not attached.

3. To install, reverse the removal procedure.

Note: Make sure that the wiper blade locks into place.

CHANGING A BULB

WARNING: Switch the lamps and the ignition off. Failure to do so could result in serious personal injury.

WARNING: Bulbs can become hot. Let the bulb cool down before removing it. Failure to do so could result in personal injury.

Use the correct specification bulb. See **Bulb Specification Chart** (page 412). Install in the reverse order unless otherwise stated.

Rear Direction Indicator and Reversing Lamp

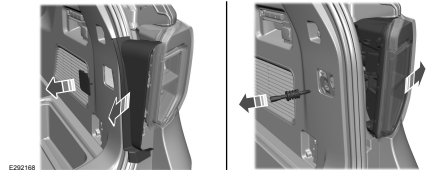

1. Switch all of the lamps and the ignition off.
2. Use a suitable tool, for example a screwdriver, to carefully remove the access cover.
3. Remove the side cover.
4. Remove the screw that secures the lamp assembly.

Maintenance

5. Gently pull the lamp assembly away from the vehicle.
6. Turn the bulb holder counterclockwise and remove it.
7. Remove the bulb by pulling it straight out.

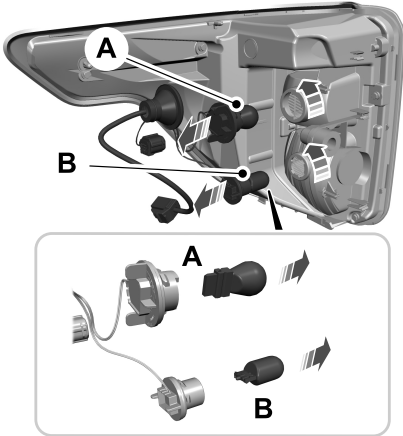

E292171

- A Rear direction indicator.
B Reverse lamp.

LED Lamps

LED lamps are not serviceable items. See an authorized dealer if they fail.

The following lamps are LED:

- Headlamp low beam.
- Headlamp high beam.
- Front direction indicator.
- Side direction indicator.
- Daytime running lamps.
- Front fog lamps (if equipped).
- Brake and rear lamp.
- Rear side marker lamp.

- Rear fog lamps (if equipped).
- Front side marker lamps.
- Front signature lamps.
- Central high mounted brake lamp.

License Plate Lamp

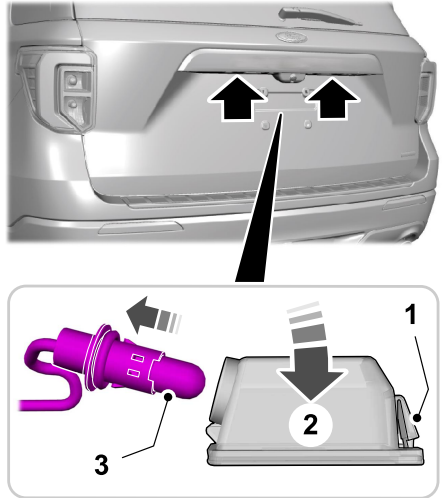

1. Use a suitable tool, for example a screwdriver, to carefully remove the lamp.
2. Turn the bulb holder counterclockwise and remove it.
3. Remove the bulb by pulling it straight out.

Vehicle Care

GENERAL INFORMATION

Your dealer has many quality products available to clean your vehicle and protect its finishes.

CLEANING PRODUCTS

Materials

For best results, use the following products or products of equivalent quality:

For additional information and assistance, we recommend that you contact an authorized dealer.

Name	Specification
Motorcraft® Bug and Tar Remover, ZC-42 (U.S. & Canada)	
Motorcraft® Custom Bright Metal Cleaner, ZC-15 (U.S. & Canada)	ESR-M5B194-B
Motorcraft® Detail Wash, ZC-3-A (U.S. & Canada)	ESR-M14P4-A
Motorcraft® Engine Shampoo and Degreaser, ZC-20 (U.S.)	ESR-M14P3-A
Motorcraft® Engine Shampoo, CXC-66-A (Canada)	
Motorcraft® Premium Leather and Vinyl Cleaner, ZC-56 (U.S. & Canada)	
Motorcraft® Multi-Purpose Cleaner, CXC-101 (Canada)	
Motorcraft® Premium Windshield Wash Concentrate with Bitterant, ZC-32-B2 (U.S.)	WSS-M14P19-A
Motorcraft® Premium Quality Windshield Washer Fluid, CXC-37-F/M (Canada)	WSS-M14P19-A
Motorcraft® Professional Strength Carpet & Upholstery Cleaner, ZC-54 (U.S. & Canada)	
Motorcraft® Premium Glass Cleaner, CXC-100 (Canada)	ESR-M14P5-A
Motorcraft® Spot and Stain Remover, ZC-14 (U.S.)	
Motorcraft® Ultra-Clear Spray Glass Cleaner, ZC-23 (U.S.)	ESR-M14P5-A
Motorcraft® Wheel and Tire Cleaner, ZC-37-A (U.S. & Canada)	

Vehicle Care

CLEANING THE EXTERIOR

Wash your vehicle regularly with cool or lukewarm water and a neutral pH shampoo, we recommend Motorcraft Detail Wash.

- Never use strong household detergents or soap, for example dish washing or laundry liquid. These products can discolor and spot painted surfaces.
- Never wash your vehicle when it is hot to the touch, or during strong or direct sunlight.
- Dry your vehicle with a chamois or soft terry cloth towel to eliminate water spotting.
- Immediately remove fuel spillages, bird droppings, insect deposits and road tar. These may cause damage to your vehicle's paintwork or trim over time. We recommend Motorcraft Bug and Tar Remover.
- Remove any exterior accessories, for example antennas, before entering a car wash.
- When filling with AdBlue®, remove any residue on painted surfaces immediately.

Note: *Suntan lotions and insect repellents can damage painted surfaces. If these substances come in contact with your vehicle, wash the affected area as soon as possible.*

Cleaning the Exterior Precautions

Immediately remove fuel spillages, AdBlue residuals, bird droppings, insect deposits and road tar. These may cause damage to your vehicle's paintwork or trim over time.

Remove any exterior accessories, for example antennas, before entering a car wash.

Cleaning the Exterior Lamps

Note: *Do not scrape the exterior lamps lenses or use abrasives, alcoholic solvents or chemical solvents to clean them.*

Note: *Do not wipe the exterior lamps when they are dry.*

Exterior Chrome Parts

- Apply a high quality-cleaning product to bumpers and other chrome parts. Follow the manufacturer's instructions. We recommend Motorcraft Custom Bright Metal Cleaner.
- Do not apply the cleaning product to hot surfaces. Do not leave the cleaning product on chrome surfaces longer than the time recommended.
- Using non-recommended cleaners can result in severe and permanent cosmetic damage.

Note: *Never use abrasive materials, for example steel wool or plastic pads as they can scratch the chrome surface.*

Note: *Do not use chrome cleaner, metal cleaner or polish on wheels or wheel covers.*

Exterior Plastic Parts

For routine cleaning we recommend Motorcraft Detail Wash. If tar or grease spots are present, we recommend Motorcraft Bug and Tar Remover.

Stripes or Graphics (If Equipped)

Hand washing your vehicle is preferred however, pressure washing may be used under the following conditions:

- Do not use water pressure higher than 2,000 psi (14,000 kPa).
- Do not use water hotter than 179°F (82°C).

Vehicle Care

- Use a spray with a 40 degree wide spray angle pattern.
- Keep the nozzle at a 12 in (305 mm) distance and 90 degree angle to your vehicle's surface.

Note: *Holding the pressure washer nozzle at an angle to the vehicle's surface may damage graphics and cause the edges to peel away from the vehicle's surface.*

Underbody

Regularly clean the entire underside of your vehicle. This includes the chassis, body floor sheet metal and wheel wells using fresh water. Keep body and door drain holes free of debris or foreign material.

Under Hood

For removing black rubber marks from under the hood we recommend Motorcraft Wheel and Tire Cleaner or Motorcraft Bug and Tar Remover.

WAXING

Regular waxing is necessary to protect your car's paint from the elements. We recommend that you wash and wax the painted surface once or twice a year.

When washing and waxing, park your vehicle in a shaded area out of direct sunlight. Always wash your vehicle before applying wax.

- Use a quality wax that does not contain abrasives.
- Follow the manufacturer's instructions to apply and remove the wax.
- Apply a small amount of wax in a back-and-forth motion, not in circles.

- Do not allow wax to come in contact with any non-body (low-gloss black) colored trim. The wax will discolor or stain the parts over time.
 - Roof racks.
 - Bumpers.
 - Grained door handles.
 - Side moldings.
 - Mirror housings.
 - Windshield cowl area.
- Do not apply wax to glass areas.
- After waxing, your car's paint should feel smooth, and be free of streaks and smudges.

CLEANING THE ENGINE

Engines are more efficient when they are clean because grease and dirt buildup keep the engine warmer than normal.

When washing:

- Take care when using a power washer to clean the engine. The high-pressure fluid could penetrate the sealed parts and cause damage.
- Do not spray a hot engine with cold water to avoid cracking the engine block or other engine components.
- Spray Motorcraft Engine Shampoo and Degreaser on all parts that require cleaning and pressure rinse clean. In Canada, use Motorcraft Engine Shampoo.

Note: *If your vehicle has an engine cover remove the cover before application of Motorcraft Engine Shampoo and Degreaser. Immediately rinse away any over spray.*

Vehicle Care

- Never wash or rinse the engine while it is hot or running; water in the running engine may cause internal damage.
- Never wash or rinse any ignition coil, spark plug wire or spark plug well, or the area in and around these locations.
- Cover the battery, power distribution box, and air filter assembly to prevent water damage when cleaning the engine.

CLEANING THE WINDOWS AND WIPER BLADES

Car wash chemicals and environmental fallout can result in windshield and wiper blade contamination. Dirty windshield and wipers will result in poor windshield wiper operation. Keep the windshield and wiper blades clean to maintain windshield wiper performance.

To clean the windshield and wiper blades:

- Clean the windshield with a non-abrasive glass cleaner. When cleaning the interior of the windshield, avoid getting any glass cleaner on the instrument panel or door panels. Wipe any glass cleaner off these surfaces immediately.
- For windshields contaminated with tree sap, chemicals, wax or bugs, clean the entire windshield using steel wool (no greater than 0000 grade) in a circular motion and rinse with water.
- Clean the wiper blades with isopropyl rubbing alcohol or windshield washer concentrate.

Note: *Do not use razor blades or other sharp objects to clean or remove decals from the inside of the heated rear window. The vehicle warranty does not cover damage caused to the heated rear window grid lines.*

CLEANING THE INTERIOR



WARNING: Do not use cleaning solvents, bleach or dye on the vehicle's seatbelts, as these actions may weaken the belt webbing.



WARNING: On vehicles equipped with seat-mounted airbags, do not use chemical solvents or strong detergents. Such products could contaminate the side airbag system and affect performance of the side airbag in a crash.

For fabric, carpets, cloth seats and seats equipped with side airbags:

- Remove dust and loose dirt with a vacuum cleaner.
- Remove light stains and soil with Motorcraft Professional Strength Carpet & Upholstery Cleaner.
- If grease or tar is present on the material, spot-clean the area first with Motorcraft Spot and Stain Remover. In Canada, use Motorcraft Multi-Purpose Cleaner.
- If a ring forms on the fabric after spot cleaning, clean the entire area immediately (but do not oversaturate) or the ring will set.
- Do not use household cleaning products or glass cleaners, which can stain and discolor the fabric and affect the flame retardant abilities of the seat materials.

Mirrors

Do not clean the housing or glass of any mirror with harsh abrasives, fuel or other petroleum or ammonia-based cleaning products.

Vehicle Care

CLEANING THE INSTRUMENT PANEL AND INSTRUMENT CLUSTER LENS



WARNING: Do not use chemical solvents or strong detergents when cleaning the steering wheel or instrument panel to avoid contamination of the airbag system.

Note: Follow the same procedure as cleaning leather seats for cleaning leather instrument panels and leather interior trim surfaces. See **Cleaning Leather Seats** (page 343).

Clean the instrument panel and cluster lens with a clean, damp and soft cloth, then use a clean, dry and soft cloth to dry these areas.

- Avoid cleaners or polishes that increase the gloss of the upper portion of the instrument panel. The dull finish in this area helps protect you from undesirable windshield reflection.
- Do not use any household cleaning products or glass cleaners as these may damage the finish of the instrument panel, interior trim and cluster lens.
- Wash or wipe your hands clean if you have been in contact with certain products such as insect repellent and suntan lotion to avoid possible damage to the interior painted surfaces.
- Do not allow air fresheners and hand sanitizers to spill onto interior surfaces. If a spill occurs, wipe off immediately. Your warranty may not cover these damages.

If a staining liquid like coffee or juice has been spilled on the instrument panel or on interior trim surfaces:

1. Wipe up spilled liquid using a clean, soft cloth as quickly as possible.
2. Use Motorcraft Premium Leather and Vinyl Cleaner or a commercially available leather cleaning product for automotive interiors. Test any cleaner or stain remover on an inconspicuous area.
3. Alternatively, wipe the surface with a clean, soft cloth and a mild soap and water solution. Dry the area with a clean, soft cloth.
4. If necessary, apply more soap and water solution or cleaning product to a clean, soft cloth and press it onto the soiled area. Allow this to set at room temperature for 30 minutes.
5. Remove the soaked cloth, then with a clean, damp cloth, use a rubbing motion for 60 seconds on the soiled area.
6. Dry the area with a clean, soft cloth.

CLEANING LEATHER SEATS

Note: Follow the same procedure as cleaning leather seats for cleaning leather instrument panels and leather interior trim surfaces.

For routine cleaning, wipe the surface with a soft, damp cloth and a mild soap and water solution. Dry the area with a clean, soft cloth.

For cleaning and removing stains such as dye transfer, use Motorcraft Premium Leather and Vinyl Cleaner or a commercially available leather cleaning product for automotive interiors.

Note: Test any cleaner or stain remover on an inconspicuous area.

Vehicle Care

You should:

- Remove dust and loose dirt with a vacuum cleaner.
- Clean and treat spills and stains as soon as possible.

Do not use the following products as these may damage the leather:

- Oil and petroleum or silicone-based leather conditioners.
- Household cleaners.
- Alcohol solutions.
- Solvents or cleaners intended specifically for rubber, vinyl and plastics.

REPAIRING MINOR PAINT DAMAGE

We recommend that you contact an authorized dealer to identify your vehicle color code. Authorized dealers have touch-up paint to match your vehicle's color.

Before repairing minor paint damage, use a cleaner to remove particles such as bird droppings, tree sap, insect deposits, tar spots, road salt and industrial fallout.

Read the instructions before using cleaning products.

CLEANING THE WHEELS

1. Regularly clean them with a wheel cleaner. We recommend that you use Ford approved wheel cleaner if available.
2. Remove dirt and brake dust with a sponge.
3. Remove tar and grease with a bug and tar remover. We recommend that you use Ford approved bug and tar remover if available.

4. Thoroughly rinse the wheels with water after cleaning.

If you intend on parking your vehicle for an extended period after cleaning the wheels with a wheel cleaner, drive your vehicle for a few minutes before doing so. This reduces the risk of corrosion of the brake discs, brake pads and linings.

Do not clean the wheels when they are hot.

Note: *Some car washes could damage wheel rims and covers.*

Note: *Using non-recommended cleaners, harsh cleaning products, chrome wheel cleaners or abrasive materials could damage wheel rims, covers and bolts.*

VEHICLE STORAGE

If you plan on storing your vehicle for 30 days or more, read the following maintenance recommendations to make sure your vehicle stays in good operating condition.

We engineer and test all motor vehicles and their components for reliable, regular driving. Under various conditions, long-term storage may lead to degraded engine performance or failure unless you use specific precautions to preserve engine components.

General

- Store all vehicles in a dry, ventilated place.
- Protect from sunlight, if possible.
- If vehicles are stored outside, they require regular maintenance to protect against rust and damage.

Vehicle Care

Body

- Wash your vehicle thoroughly to remove dirt, grease, oil, tar or mud from exterior surfaces, rear-wheel housing and the underside of front fenders.
- Periodically wash your vehicle if it is stored in exposed locations.
- Touch-up exposed or primed metal to prevent rust.
- Cover chrome and stainless steel parts with a thick coat of auto wax to prevent discoloration. Re-wax as necessary when you wash your vehicle.
- Lubricate all hood, door and luggage compartment hinges and latches with a light grade oil.
- Cover interior trim to prevent fading.
- Keep all rubber parts free from oil and solvents.

Engine

- Change the engine oil and filter prior to storage because used engine oil contains contaminants which may cause engine damage.
- Start the engine every 15 days for a minimum of 15 minutes. Run at fast idle with the climate controls set to defrost until the engine reaches normal operating temperature.
- With your foot on the brake, shift through all the gears while the engine is running.
- We recommend that you change the engine oil before you use your vehicle again.

Fuel system

- Fill the fuel tank with high-quality fuel until the first automatic shutoff of the fuel pump nozzle.

Cooling system

- Protect against freezing temperatures.
- When removing your vehicle from storage, check coolant fluid level. Confirm that there are no cooling system leaks and that fluid is at the recommended level.

Disconnecting Your 12 Volt Battery

- Check and recharge as necessary. Keep connections clean.
- If storing your vehicle for more than 30 days without recharging the battery, we recommend that you disconnect the battery cables to maintain battery charge for quick starting.

Note: *It is necessary to reset memory features if you disconnect the battery cables.*

Brakes

- Make sure the brakes and parking brake release fully.

Tires

- Maintain recommended air pressure.

Miscellaneous

- Make sure all linkages, cables, levers and pins under your vehicle are covered with grease to prevent rust.
- Move vehicles at least 25 ft (7.5 m) every 15 days to lubricate working parts and prevent corrosion.

Vehicle Care

Removing Vehicle From Storage

When your vehicle is ready to come out of storage, do the following:

- Wash your vehicle to remove any dirt or grease film build-up on window surfaces.
- Check windshield wipers for any deterioration.
- Check under the hood for any foreign material that may have collected during storage such as mice or squirrel nests.
- Check the exhaust for any foreign material that may have collected during storage.
- Check tire pressures and set tire inflation per the Tire Label.
- Check brake pedal operation. Drive your vehicle 15 ft (4.5 m) back and forth to remove rust build-up.
- Check fluid levels (including coolant, oil and gas) to make sure there are no leaks, and fluids are at recommended levels.
- If you remove the battery, clean the battery cable ends and check for damage.

Contact an authorized dealer if you have any concerns or issues.

BODY STYLING KITS

The distance between the underside of your vehicle and the ground is less than that of other models. Drive with extreme care to avoid damage to your vehicle.

Wheels and Tires

GENERAL INFORMATION

The recommended tire inflation pressures are found on the Tire Label which is located on the B-pillar or the edge of the driver door. This information can also be found on the Safety Compliance Certification Label, affixed to either the door hinge pillar, door-latch post, or the door edge that meets the door-latch post, next to the driver's seating position.

We strongly recommend maintaining these tire pressures at all times. Failure to follow the tire pressure recommendations can cause uneven treadwear patterns, reduced fuel economy, and adversely affect the way your vehicle handles.

Note: *Check and set the tire pressure at the ambient temperature in which you are intending to drive your vehicle and when the tires are cold.*

Note: *Check your tire pressures at least once per month.*

If your vehicle has a spare tire, set the pressure to the highest value given for your vehicle and tire size combination.

Use only approved wheels and tire sizes; using other sizes could damage your vehicle.

If you change the diameter of the factory installed tires, the speedometer could display the incorrect speed. This could effect the functionality of the 4WD system (if equipped). Take your vehicle to an authorized dealer and have the engine management system reprogrammed.

If you intend to change the size of the factory installed tires, check the suitability with an authorized dealer.

Additional information related to the functionality and maintenance of your tires can be found in the Wheels and Tire section. See **Tire Care** (page 349).

Self-Sealing Tires (If Equipped)

Self-Sealing tires are a special type of tire that have a material on the inside of the tire that can seal punctures up to 0.2 in (6 mm) in diameter in the tread area. This material does not protect from damage or punctures in the sidewall of the tire. Self-sealing tires can be identified by the tire manufacturer with a special mark.

If your TPMS warning light comes on, inspect your tires for damage and re-inflate your tires to the pressure indicated on the tire placard. See **Tire Pressure Monitoring System** (page 364). If your tires are damaged or continue to lose air, take your vehicle to the nearest authorized dealer to have your tires inspected and repaired/replaced as necessary.

Note: *Replace self-sealing tires with self-sealing tires to maintain the functionality provided.*

Note: *Do not drive on a deflated self-sealing tire. This damages the tire beyond repair.*

Notice to utility vehicle and truck owners



WARNING: Vehicles with a higher center of gravity (utility and four-wheel drive vehicles) handle differently than vehicles with a lower center of gravity (passenger cars). Avoid sharp turns, excessive speed and abrupt steering in these vehicles. Failure to drive cautiously increases the risk of losing control of your vehicle, vehicle rollover, personal injury and death.



WARNING: In a rollover crash, an unbelted person is significantly more likely to die than a person wearing a seatbelt.

Wheels and Tires

Utility vehicles and trucks handle differently than passenger cars in the various driving conditions that are encountered on streets, highways and off-road. Utility vehicles and trucks are not designed for cornering at speeds as high as passenger cars any more than low-slung sports cars are designed to perform satisfactorily under off-road conditions.

Study your owner's manual and any supplements for specific information about equipment features, instructions for safe driving and additional precautions to reduce the risk of an accident or serious injury.

Four-Wheel Drive system (if equipped)



WARNING: Do not become overconfident in the ability of four-wheel drive vehicles. Although a four-wheel drive vehicle may accelerate better than a two-wheel drive vehicle in low traction situations, it won't stop any faster than two-wheel drive vehicles. Always drive at a safe speed.

A vehicle equipped with Four-Wheel Drive has the ability to use all four wheels to power itself. This increases traction which may enable you to safely drive over terrain and road conditions that a conventional two-wheel drive vehicle cannot. Power is supplied to all four wheels through a transfer case. Four-wheel drive vehicles allow you to select different modes as necessary. You can find more information on transfer case operation, drive mode selection, and transfer case maintenance in this manual. See **Four-Wheel Drive** (page 203). You should become thoroughly familiar with this information before you operate your vehicle.

We recommend installing the temporary spare wheel and tire on the front axle when possible. This could provide limited 4WD traction.

Four-wheel drive: Never use a spare tire of a different size than the one provided with your vehicle. This could cause the four-wheel drive system to default to rear-wheel drive.

How your vehicle differs from other vehicles

Sport utility vehicles and trucks can differ from some other vehicles in a few noticeable ways. Your vehicle may be:

- Higher - to allow higher load carrying capacity and to allow it to travel over rough terrain without getting hung up or damaging underbody components.
- Shorter - to give it the capability to approach inclines and drive over the crest of a hill without getting hung up or damaging underbody components. All other things held equal, a shorter wheelbase may make your vehicle quicker to respond to steering inputs than a vehicle with a longer wheelbase.
- Narrower - to provide greater maneuverability in tight spaces, particularly in off-road use.

As a result of the above dimensional differences, sport utility vehicles and trucks often have a higher center of gravity and a greater difference in center of gravity between the loaded and unloaded condition. These differences that make your vehicle so versatile also make it handle differently than an ordinary passenger car.

Wheels and Tires

TIRE CARE

Information About Uniform Tire Quality Grading



Tire Quality Grades apply to new pneumatic passenger car tires. The Quality grades can be found where applicable on the tire sidewall between tread shoulder and maximum section width. For example: **Treadwear 200 Traction AA Temperature A.**

These Tire Quality Grades are determined by standards that the United States Department of Transportation has set.

Tire Quality Grades apply to new pneumatic passenger car tires. They do not apply to deep tread, winter-type snow tires, space-saver or temporary use spare tires, light truck or LT type tires, tires with nominal rim diameters of 10 to 12 inches or limited production tires as defined in Title 49 Code of Federal Regulations Part 575.104 (c)(2).

U.S. Department of Transportation Tire quality grades:

The U.S. Department of Transportation requires us to give you the following information about tire grades exactly as the government has written it.

Treadwear

The treadwear grade is a comparative rating based on the wear rate of the tire when tested under controlled conditions on a specified government test course. For example, a tire graded 150 would wear 1½ times as well on the government course as a tire graded 100. The relative performance of tires depends upon the actual conditions of their use, however, and may depart significantly from the norm due to variations in driving habits, service practices, and differences in road characteristics and climate.

Traction AA A B C



WARNING: The traction grade assigned to this tire is based on straight-ahead braking traction tests, and does not include acceleration, cornering, hydroplaning or peak traction characteristics.

Wheels and Tires

The traction grades, from highest to lowest are AA, A, B, and C. The grades represent the tire's ability to stop on wet pavement as measured under controlled conditions on specified government test surfaces of asphalt and concrete. A tire marked C may have poor traction performance.

Temperature A B C



WARNING: The temperature grade for this tire is established for a tire that is properly inflated and not overloaded. Excessive speed, underinflation, or excessive loading, either separately or in combination, can cause heat buildup and possible tire failure.

The temperature grades are A (the highest), B and C, representing the tire's resistance to the generation of heat and its ability to dissipate heat when tested under controlled conditions on a specified indoor laboratory test wheel. Sustained high temperature can cause the material of the tire to degenerate and reduce tire life, and excessive temperature can lead to sudden tire failure. The grade C corresponds to a level of performance which all passenger car tires must meet under the

Federal Motor Vehicle Safety Standard No. 139. Grades B and A represent higher levels of performance on the laboratory test wheel than the minimum required by law.

Glossary of Tire Terminology

***Tire label:** A label showing the original equipment tire sizes, recommended inflation pressure and the maximum weight the vehicle can carry.

***Tire Identification Number (TIN):** A number on the sidewall of each tire providing information about the tire brand and manufacturing plant, tire size and date of manufacture. Also referred to as DOT code.

***Inflation pressure:** A measure of the amount of air in a tire.

***Standard load:** A class of P-metric or Metric tires designed to carry a maximum load at set pressure. For example: For P-metric tires 35 psi (2.4 bar) and for Metric tires 36 psi (2.5 bar). Increasing the inflation pressure beyond this pressure will not increase the tire's load carrying capability.

***Extra load:** A class of P-metric or Metric tires designed to carry a heavier maximum load at 42 psi (2.9 bar). Increasing the inflation pressure beyond this pressure will not increase the tire's load carrying capability.

Wheels and Tires

***kPa:** Kilopascal, a metric unit of air pressure.

***PSI:** Pounds per square inch, a standard unit of air pressure.

***Cold tire pressure:** The tire pressure when the vehicle has been stationary and out of direct sunlight for an hour or more and prior to the vehicle being driven for 1 mi (1.6 km).

***Recommended inflation pressure:** The cold inflation pressure found on the Safety Compliance Certification Label (affixed to either the door hinge pillar, door-latch post, or the door edge that meets the door-latch post, next to the driver's seating position), or Tire Label located on the B-Pillar or the edge of the driver door.

***B-pillar:** The structural member at the side of the vehicle behind the front door.

***Bead area of the tire:** Area of the tire next to the rim.

***Sidewall of the tire:** Area between the bead area and the tread.

***Tread area of the tire:** Area of the perimeter of the tire that contacts the road when mounted on the vehicle.

***Rim:** The metal support (wheel) for a tire or a tire and tube assembly upon which the tire beads are seated.

Information Contained on the Tire Sidewall

Both United States and Canada Federal regulations require tire manufacturers to place standardized information on the sidewall of all tires. This information identifies and describes the fundamental characteristics of the tire and also provides a U.S. DOT Tire Identification Number for safety standard certification and in case of a recall.

Information on P Type Tires

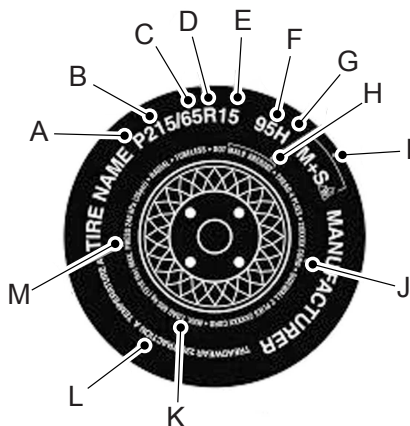

P215/65R15 95H is an example of a tire size, load index and speed rating. The definitions of these items are listed below. (Note that the tire size, load index and speed rating for your vehicle may be different from this example.)

Wheels and Tires

A. **P:** Indicates a tire, designated by the Tire and Rim Association, that may be used for service on cars, sport utility vehicles, minivans and light trucks. **Note:** If your tire size does not begin with a letter this may mean it is designated by either the European Tire and Rim Technical Organization or the Japan Tire Manufacturing Association.

B. **215:** Indicates the nominal width of the tire in millimeters from sidewall edge to sidewall edge. In general, the larger the number, the wider the tire.

C. **65:** Indicates the aspect ratio which gives the tire's ratio of height to width.

D. **R:** Indicates a radial type tire.

E. **15:** Indicates the wheel or rim diameter in inches. If you change your wheel size, you will have to purchase new tires to match the new wheel diameter.

F. **95:** Indicates the tire's load index. It is an index that relates to how much weight a tire can carry. You may find this information in your owner's manual. If not, contact a local tire dealer.

Note: *You may not find this information on all tires because it is not required by federal law.*

G. **H:** Indicates the tire's speed rating. The speed rating denotes the speed at which a tire is designed to be driven for extended periods of time under a standard condition of load and inflation pressure. The tires on your vehicle may operate at different conditions for load and inflation pressure. These speed ratings may need to be adjusted for the difference in conditions. The ratings range from 81 mph (130 km/h) to 186 mph (299 km/h). These ratings are listed in the following chart.

Note: *You may not find this information on all tires because it is not required by federal law.*

Letter rating	Speed rating
M	81 mph (130 km/h)
N	87 mph (140 km/h)
Q	99 mph (159 km/h)
R	106 mph (171 km/h)
S	112 mph (180 km/h)
T	118 mph (190 km/h)
U	124 mph (200 km/h)
H	130 mph (210 km/h)
V	149 mph (240 km/h)

Wheels and Tires

Letter rating	Speed rating
W	168 mph (270 km/h)
Y	186 mph (299 km/h)

Note: For tires with a maximum speed capability over 149 mph (240 km/h), tire manufacturers sometimes use the letters ZR. For those with a maximum speed capability over 186 mph (299 km/h), tire manufacturers always use the letters ZR.

H. U.S. DOT Tire Identification Number (TIN): This begins with the letters DOT and indicates that the tire meets all federal standards. The next two numbers or letters are the plant code designating where it was manufactured, the next two are the tire size code and the last four numbers represent the week and year the tire was built. For example, the numbers 317 mean the 31st week of 1997. After 2000, the numbers go to four digits. For example, 2501 means the 25th week of 2001. The numbers in between are identification codes used for traceability. This information is used to contact customers if a tire defect requires a recall.

I. M+S or M/S: Mud and Snow, or
AT: All Terrain, or
AS: All Season.

J. Tire Ply Composition and Material Used: Indicates the number of plies or the number of layers of rubber-coated fabric in the tire tread and sidewall. Tire manufacturers also must indicate the ply materials in the tire and the sidewall, which include steel, nylon, polyester, and others.

K. Maximum Load: Indicates the maximum load in kilograms and pounds that can be carried by the tire. See the Safety Compliance Certification Label (affixed to either the door hinge pillar, door-latch post, or the door edge that meets the door-latch post, next to the driver's seating position), for the correct tire pressure for your vehicle.

L. Treadwear, Traction and Temperature Grades:

***Treadwear** The treadwear grade is a comparative rating based on the wear rate of the tire when tested under controlled conditions on a specified government test course. For example, a tire graded 150 would wear one and one-half times as well on the government course as a tire graded 100.

Wheels and Tires

***Traction:** The traction grades, from highest to lowest are AA, A, B, and C. The grades represent the tire's ability to stop on wet pavement as measured under controlled conditions on specified government test surfaces of asphalt and concrete. A tire marked C may have poor traction performance.

***Temperature:** The temperature grades are A (the highest), B and C, representing the tire's resistance to the generation of heat and its ability to dissipate heat when tested under controlled conditions on a specified indoor laboratory test wheel.

M. Maximum Inflation Pressure:

Indicates the tire manufacturers' maximum permissible pressure or the pressure at which the maximum load can be carried by the tire. This pressure is normally higher than the vehicle manufacturer's recommended cold inflation pressure which can be found on the Safety Compliance Certification Label (affixed to either the door hinge pillar, door-latch post, or the door edge that meets the door-latch post, next to the driver's seating position), or Tire Label which is located on the B-Pillar or the edge of the driver's door. The cold inflation pressure should never be set lower than the recommended pressure on the vehicle label.

The tire suppliers may have additional markings, notes or warnings such as standard load or radial tubeless.

Additional Information Contained on the Tire Sidewall for LT Type Tires

Note: *Tire Quality Grades do not apply to this type of tire.*

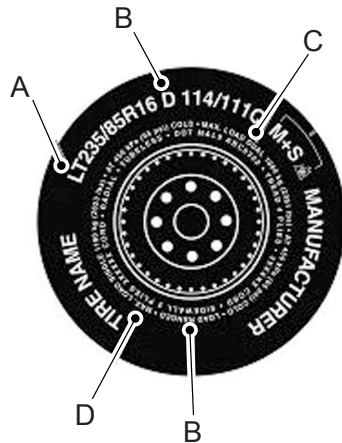

LT type tires have some additional information beyond those of P type tires; these differences are described below.

A. LT: Indicates a tire, designated by the Tire and Rim Association, that is intended for service on light trucks.

B. Load Range and Load Inflation Limits: Indicates the tire's load-carrying capabilities and its inflation limits.

Wheels and Tires

C. Maximum Load Dual lb (kg) at psi (kPa) cold: Indicates the maximum load and tire pressure when the tire is used as a dual, defined as four tires on the rear axle (a total of six or more tires on the vehicle).

D. Maximum Load Single lb (kg) at psi (kPa) cold: Indicates the maximum load and tire pressure when the tire is used as a single, defined as two tires (total) on the rear axle.

Information on T Type Tires

T145/80D16 is an example of a tire size.

Note: *The temporary tire size for your vehicle may be different from this example. Tire Quality Grades do not apply to this type of tire.*

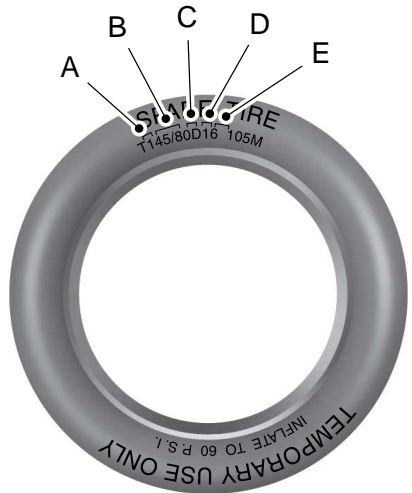

T type tires have some additional information beyond those of P type tires; these differences are described below:

A. T: Indicates a type of tire, designated by the Tire and Rim Association, that is intended for temporary service on cars, sport utility vehicles, minivans and light trucks.

B. 145: Indicates the nominal width of the tire in millimeters from sidewall edge to sidewall edge. In general, the larger the number, the wider the tire.

Wheels and Tires

C. **80:** Indicates the aspect ratio which gives the tire's ratio of height to width. Numbers of 70 or lower indicate a short sidewall.

D. **D:** Indicates a diagonal type tire.

R: Indicates a radial type tire.

E. **16:** Indicates the wheel or rim diameter in inches. If you change your wheel size, you will have to purchase new tires to match the new wheel diameter.

Recommended Tire Pressures and Inflating Your Tires

Safe operation of your vehicle requires that your tires are properly inflated. Remember that a tire can lose up to half of its air pressure without appearing flat. Every day before you drive, check your tires. If one looks lower than the others, use a tire gauge to check the pressure of all tires and adjust if required.

At least once a month and before long trips, inspect each tire and check the tire pressure with a tire gauge (including spare, if equipped). Inflate all tires to the inflation pressure recommended by the manufacturer.



WARNING: Under-inflation is the most common cause of tire failures and may result in severe tire cracking, tread separation or blowout, with unexpected loss of vehicle

control and increased risk of injury. Under-inflation increases sidewall flexing and rolling resistance, resulting in heat buildup and internal damage to the tire. It also may result in unnecessary tire stress, irregular wear, loss of vehicle control and accidents. A tire can lose up to half of its air pressure and not appear to be flat!

You are strongly urged to buy a reliable tire pressure gauge, as automatic service station gauges may be inaccurate. We recommend the use of a digital or dial-type tire pressure gauge rather than a stick-type tire pressure gauge. Use the recommended cold inflation pressure for optimum tire performance and wear. Under-inflation or over-inflation may cause uneven treadwear patterns.

Always inflate your tires to the recommended inflation pressure even if it is less than the maximum inflation pressure information found on the tire. You will find a Tire Label containing the manufacturer's recommended tire inflation pressure by the tire size and other important information located on the B-Pillar or the edge of the driver's door).

Wheels and Tires

The recommended tire inflation pressure is also found on the Safety Compliance Certification Label (affixed to either the door hinge pillar, door-latch post, or the door edge that meets the door-latch on the B-pillar, or on the edge of the driver's door.

Failure to follow the tire pressure recommendations can cause uneven treadwear patterns and adversely affect the way your vehicle handles.

Inspecting Your Tires and Wheel Valve Stems

Periodically inspect the tire treads for uneven or excessive wear and remove objects such as stones, nails or glass that may be wedged in the tread grooves. Check the tire and valve stems for holes, cracks, or cuts that may permit air leakage and repair or replace the tire and replace the valve stem. Inspect the tire sidewalls for cracking, cuts, bruises and other signs of damage or excessive wear. If internal damage to the tire is suspected, have the tire dismantled and inspected in case it needs to be repaired or replaced. For your safety, tires that are damaged or show signs of excessive wear should not be used because they are more likely to blow out or fail.

Improper or inadequate vehicle maintenance can cause tires to wear abnormally. Inspect all your tires, including the spare, frequently, and replace them if one or more of the following conditions exist:

Tire Wear

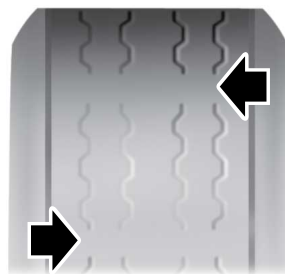

When the tread is worn down to one sixteenth of an inch (2 mm), tires must be replaced to help prevent your vehicle from skidding and hydroplaning. Built-in treadwear indicators, or wear bars, which look like narrow strips of smooth rubber across the tread will appear on the tire when the tread is worn down to one sixteenth of an inch (2 mm).

When the tire tread wears down to the same height as these wear bars, the tire is worn out and must be replaced.

Wheels and Tires

Damage

Periodically inspect the tire treads and sidewalls for damage (such as bulges in the tread or sidewalls, cracks in the tread groove and separation in the tread or sidewall). If damage is observed or suspected, have the tire inspected by a tire professional. Tires can be damaged during off-road use, so inspection after off-road use is also recommended.

Age



WARNING: Tires degrade over time depending on many factors such as weather, storage conditions, and conditions of use (load, speed, inflation pressure) the tires experience throughout their lives.

In general, tires should be replaced after six years regardless of tread wear. However, heat caused by hot climates or frequent high loading conditions can accelerate the aging process and may require tires to be replaced more frequently.

You should replace your spare tire when you replace the road tires or after six years due to aging even if it has not been used.

U.S. DOT Tire Identification Number

Both United States and Canada Federal regulations require tire manufacturers to place standardized information on the sidewall of all tires. This information identifies and describes the fundamental characteristics of the tire and also provides a U.S. DOT Tire Identification Number for safety standard certification and in case of a recall.

This begins with the letters DOT and indicates that the tire meets all federal standards. The next two numbers or letters are the plant code designating where it was manufactured, the next two are the tire size code and the last four numbers represent the week and year the tire was built. For example, the numbers 317 mean the 31st week of 1997. After 2000, the numbers go to four digits. For example, 2501 means the 25th week of 2001. The numbers in between are identification codes used for traceability. This information is used to contact customers if a tire defect requires a recall.

Tire Replacement Requirements

Your vehicle is equipped with tires designed to provide a safe ride and handling capability.

Wheels and Tires



WARNING: Only use replacement tires and wheels that are the same size, load index, speed rating and type (such as P-metric versus LT-metric or all-season versus all-terrain) as those originally provided by Ford. The recommended tire and wheel size may be found on either the Safety Compliance Certification Label (affixed to either the door hinge pillar, door-latch post, or the door edge that meets the door-latch post, next to the driver's seating position), or the Tire Label which is located on the B-Pillar or edge of the driver's door. If this information is not found on these labels, then you should contact your authorized dealer as soon as possible. Use of any tire or wheel not recommended by Ford can affect the safety and performance of your vehicle, which could result in an increased risk of loss of vehicle control, vehicle rollover, personal injury and death.



WARNING: To reduce the risk of serious injury, when mounting replacement tires and wheels, you should not exceed the maximum pressure indicated on the sidewall of the tire to set the beads without additional precautions listed below. If the beads do not seat at the maximum pressure indicated, re-lubricate and try again.



WARNING: For a mounting pressure more than 20 psi (1.38 bar) greater than the maximum pressure, a Ford dealer or other tire service professional should do the mounting.



WARNING: Always inflate steel carcass tires with a remote air fill with the person inflating standing at a minimum of 12 ft (3.66 m) away from the wheel and tire assembly.



WARNING: When inflating the tire for mounting pressures up to 20 psi (1.38 bar) greater than the maximum pressure on the tire sidewall, the following precautions must be taken to protect the person mounting the tire:

- Make sure that you have the correct tire and wheel size.
- Lubricate the tire bead and wheel bead seat area again.

Wheels and Tires

- Stand at a minimum of 12 ft (3.66 m) away from the wheel and tire assembly.
- Use both eye and ear protection.

Important: Remember to replace the wheel valve stems when the road tires are replaced on your vehicle.

It is recommended that the two front tires or two rear tires generally be replaced as a pair if the worn tires still have usable depth.

To avoid potential Four-Wheel Drive (4WD) malfunction or (4WD) system damage, it is recommended to replace all four tires rather than mixing significantly worn tires with new tires.

The tire pressure sensors mounted in the wheels (originally installed on your vehicle) are not designed to be used in aftermarket wheels.

The use of wheels or tires not recommended may affect the operation of your tire pressure monitoring system.

If the tire pressure monitoring system indicator is flashing, your system is malfunctioning. Your replacement tire might be incompatible with your tire pressure monitoring system, or some component of the system may be damaged.

Safety Practices



WARNING: If your vehicle is stuck in snow, mud or sand, do not rapidly spin the tires; spinning the tires can tear the tire and cause an explosion. A tire can explode in as little as three to five seconds.



WARNING: Do not spin the wheels at over 34 mph (55 km/h). The tires may fail and injure a passenger or bystander.

Driving habits have a great deal to do with your tire mileage and safety.

- *Observe posted speed limits
- *Avoid fast starts, stops and turns
- *Avoid potholes and objects on the road
- *Do not run over curbs or hit the tire against a curb when parking

Highway Hazards

No matter how carefully you drive, there is always the possibility that you may eventually have a flat tire on the highway. Drive slowly to the closest safe area out of traffic. This may further damage the flat tire, but your safety is more important.

Wheels and Tires

If you feel a sudden vibration or ride disturbance while driving, or you suspect your tire or vehicle has been damaged, immediately reduce your speed. Drive with caution until you can safely pull off the road. Stop and inspect the tires for damage. If a tire is under-inflated or damaged, deflate it, remove wheel and replace it with your spare tire and wheel. If you cannot detect a cause, have the vehicle towed to the nearest repair facility or tire dealer to have the vehicle inspected.

Tire and Wheel Alignment

A bad jolt from hitting a curb or pothole can cause the front end of your vehicle to become misaligned or cause damage to your tires. If your vehicle seems to pull to one side when you are driving, the wheels may be out of alignment. Have an authorized dealer check the wheel alignment periodically.

Wheel misalignment in the front or the rear can cause uneven and rapid treadwear of your tires and should be corrected by an authorized dealer. Front-wheel drive vehicles and those with an independent rear suspension (if equipped) may require alignment of all four wheels.

The tires should also be balanced periodically. An unbalanced tire and wheel assembly may result in irregular tire wear.

Tire Rotation



WARNING: If the tire label shows different tire pressures for the front and rear tires and the vehicle has a tire pressure monitoring system, then you need to update the settings for the system sensors. Always perform the system reset procedure after tire rotation. If you do not reset the system, it may not provide a low tire pressure warning when necessary.

Note: *If your tires show uneven wear, ask an authorized dealer to check for and correct any wheel misalignment, tire imbalance or mechanical problem involved before tire rotation.*

Note: *Your vehicle may be equipped with a dissimilar spare wheel and tire assembly. A dissimilar spare wheel and tire assembly is defined as a spare wheel and tire assembly that is different in brand, size or appearance from the road tires and wheels. If you have a dissimilar spare wheel and tire assembly, it is intended for temporary use only and should not be used in a tire rotation.*

Note: *After having your tires rotated, inflation pressure must be checked and adjusted to the vehicle requirements.*

Wheels and Tires

Rotating your tires at the recommended interval will help your tires wear more evenly, providing better tire performance and longer tire life. Sometimes irregular tire wear can be corrected by rotating the tires. See **Scheduled Maintenance** (page 476).

Tire Rotation Diagram

Rear-wheel drive and Four-wheel drive vehicles, front tires at left of diagram.

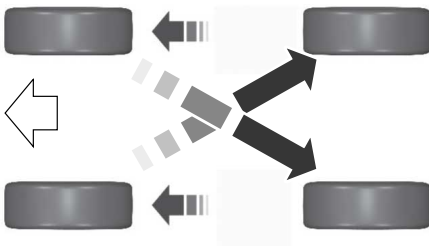

USING SUMMER TIRES

Summer tires provide superior performance on wet and dry roads. Summer tires do not have the Mud and Snow (M+S or M/S) tire traction rating on the tire side wall. Since summer tires do not have the same traction performance as All-season or Snow tires, we do not recommend using summer tires when temperatures drop to about 45°F (7°C) or below (depending on tire wear and environmental conditions) or in snow and

ice conditions. Like any tire, summer tire performance is affected by tire wear and environmental conditions. If you must drive in those conditions, we recommend using Mud and Snow (M+S, M/S), All-season or Snow tires.

Always store your summer tires indoors at temperatures above 19°F (-7°C). The rubber compounds used in these tires lose flexibility and may develop surface cracks in the tread area at temperatures below 19°F (-7°C). If the tires have been subjected to 19°F (-7°C) or less, warm them in a heated space to at least 41°F (5°C) for at least 24 hours before installing them on a vehicle, or moving the vehicle with the tires installed, or checking tire inflation. Do not place tires near heaters or heating devices used to warm the room where the tires are stored. Do not apply heat or blow heated air directly on the tires. Always inspect the tires after storage periods and before use.

USING WINTER TIRES



Inflate the winter tires to the same tire pressures as those listed in the tire pressures table.

Wheels and Tires



WARNING: Snow tires must be the same size, load index and speed rating as those originally provided by Ford. Use of any tire or wheel not recommended by Ford can affect the safety and performance of your vehicle, which could result in an increased risk of loss of control, vehicle rollover, personal injury and death. Additionally, the use of non-recommended tires and wheels can cause steering, suspension, axle, transfer case or power transfer unit failure. Follow the Ford recommended tire inflation pressure found on the Safety Compliance Certification Label (on the door hinge pillar, door latch post or the door edge that meets the door latch post, next to the driver seat), or Tire Label on the B-Pillar or the edge of the driver door. Failure to follow the tire pressure recommendations can cause uneven treadwear patterns and adversely affect the way your vehicle handles.

USING SNOW CHAINS



WARNING: Do not exceed 30 mph (50 km/h). Failure to follow this instruction could result in the loss of control of your vehicle, personal injury or death.



WARNING: Do not use snow chains on snow-free roads.



WARNING: Only fit snow chains to specified tires.



WARNING: If your vehicle is fitted with wheel trims, remove them before fitting snow chains.

Only use snow chains on rear wheels. Install snow chains in pairs. Do not use self-tensioning snow chains.

Only use snow chains on the following specified tire sizes:

- 255/60R18
 - Only install chains that are 10 mm or less.
- 255/65R18
 - Only install chains that are 10 mm or less.
- 265/60R18
 - Only install chains that are 10 mm or less.
- 255/55R20
 - Only install chains that are 10 mm or less.

We recommend you use steel wheels of the same size and specification if snow chains are required because chains may chip aluminum wheels.

Follow these guidelines when using snow tires and traction devices:

- If possible, avoid fully loading your vehicle.
- Purchase snow chains from a manufacturer that clearly labels body to tire dimension restrictions.
- When driving with snow chains do not exceed 30 mph (50 km/h) or the maximum speed recommended by the chain manufacturer, whichever is less.
- Drive cautiously. If you hear the snow chains rub or bang against the vehicle, stop and tighten them. If this does not work, remove the snow chains to prevent vehicle damage.
- Remove the snow chains when they are no longer needed. Do not use snow chains on dry roads.

Wheels and Tires

- If a temporary spare wheel is mounted on your vehicle, do not use snow chains on the axle with the temporary spare wheel.

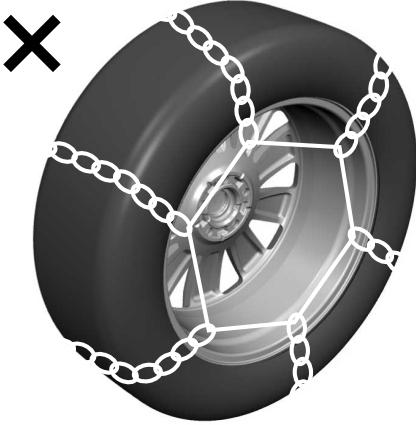

- Use snow chains that fit against the sidewall of the tire to prevent the chains from touching the wheel rims or suspension, see following illustration.

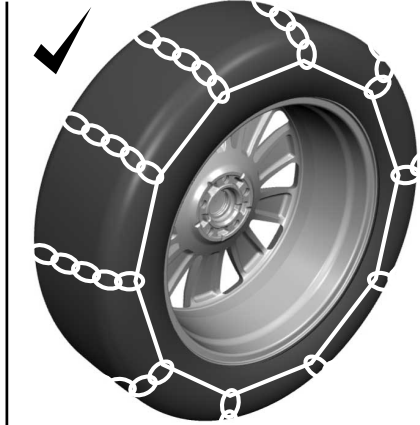

If you have any questions regarding snow chains, please contact your authorized dealer.

TIRE PRESSURE MONITORING SYSTEM



WARNING: The tire pressure monitoring system is not a substitute for manually checking tire pressures. You should periodically check tire pressures using a pressure gauge. Failure to correctly maintain tire pressures could increase the risk of tire failure, loss of control, vehicle rollover and personal injury.

Note: You should only use tire sealants in roadside emergencies as they may cause damage to the tire pressure monitoring system sensor.

Note: If the tire pressure monitoring system sensor becomes damaged, it may not function.



Each tire, including the spare (if provided), should be checked monthly when cold and inflated to the inflation pressure recommended by the vehicle manufacturer on the vehicle placard or tire inflation pressure label. (If your vehicle has tires of a different size than the size indicated on the vehicle placard or tire inflation pressure label, you should determine the proper tire inflation pressure for those tires).

Wheels and Tires

As an added safety feature, your vehicle has been equipped with a Tire Pressure Monitoring System (TPMS) that illuminates a low tire pressure telltale when one or more of your tires is significantly under-inflated. Accordingly, when the low tire pressure telltale illuminates, you should stop and check your tires as soon as possible, and inflate them to the proper pressure. Driving on a significantly under-inflated tire causes the tire to overheat and can lead to tire failure. Under-inflation also reduces fuel efficiency and tire tread life, and may affect the vehicle's handling and stopping ability.

Please note that the TPMS is not a substitute for proper tire maintenance, and it is the driver's responsibility to maintain correct tire pressure, even if under-inflation has not reached the level to trigger illumination of the TPMS low tire pressure telltale.

Your vehicle has also been equipped with a TPMS malfunction indicator to indicate when the system is not operating properly. The TPMS malfunction indicator is combined with the low tire pressure telltale. When the system detects a malfunction, the telltale will flash for approximately one minute and then remain continuously illuminated. This sequence will continue upon subsequent vehicle start-ups as long as the malfunction exists.

When the malfunction indicator is illuminated, the system may not be able to detect or signal low tire pressure as intended. TPMS malfunctions may occur for a variety of reasons, including the installation of replacement or alternate tires or wheels on the vehicle that prevent the TPMS from functioning properly. Always check the TPMS malfunction telltale after replacing one or more tires or wheels on your vehicle to ensure that the replacement or alternate tires and wheels allow the TPMS to continue to function properly.

This device complies with Part 15 of the FCC Rules and with License exempt RSS Standards of Industry Canada. Operation is subject to the following two conditions:

1. This device may not cause harmful interference, and
2. This device must accept any interference received, including interference that may cause undesired operation.



WARNING: Changes or modifications not expressly approved by the party responsible for compliance could void the user's authority to operate the equipment. The term "IC:" before the radio certification number only signifies that Industry Canada technical specifications were met.

Changing Tires With a Tire Pressure Monitoring System



Note: Each road tire is equipped with a tire pressure sensor located inside the wheel and tire assembly cavity. The pressure sensor is attached to the valve stem. The pressure sensor is covered by the tire and is not visible unless the tire is removed. Take care when changing the tire to avoid damaging the sensor.

You should always have your tires serviced by an authorized dealer.

Wheels and Tires

Check the tire pressure periodically (at least monthly) using an accurate tire gauge. See **When Inflating Your Tires** in this chapter.

Understanding Your Tire Pressure Monitoring System

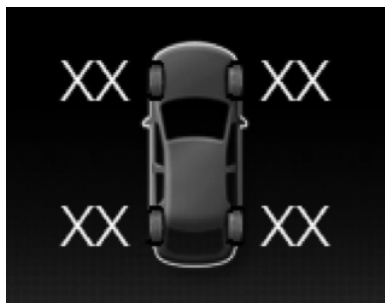

The tire pressure monitoring system measures pressure in your road tires and sends the tire pressure readings to your vehicle. You can view the tire pressure readings through the information display. See **General Information** (page 115). The low tire pressure warning light will turn on if the tire pressure is significantly low. Once

the light is illuminated, your tires are under-inflated and need to be inflated to the manufacturer's recommended tire pressure. Even if the light turns on and a short time later turns off, your tire pressure still needs to be checked.

When Your Temporary Spare Tire is Installed

When one of your road tires needs to be replaced with the temporary spare, the system will continue to identify an issue to remind you that the damaged road wheel and tire assembly needs to be repaired and put back on your vehicle.

To restore the full function of the tire pressure monitoring system, have the damaged road wheel and tire assembly repaired and remounted on your vehicle.

When You Believe Your System is Not Operating Properly

The main function of the tire pressure monitoring system is to warn you when your tires need air. It can also warn you in the event the system is no longer capable of functioning as intended. See the following chart for information concerning your tire pressure monitoring system:

Wheels and Tires

Low tire pressure warning light	Possible cause	Customer action required
Solid warning light	Tire(s) under-inflated	Make sure tires are at the proper pressure. See Inflating your tires in this chapter. After inflating your tires to the manufacturer's recommended pressure as shown on the Tire Label (located on the edge of driver's door or the B-Pillar), the vehicle must be driven for at least two minutes over 20 mph (32 km/h) before the light turns off.
	Spare tire in use	Repair the damaged road wheel and tire assembly and reinstall it on the vehicle to restore system function. For a description on how the system functions, see When Your Temporary Spare Tire is Installed in this section.
	TPMS malfunction	If the tires are properly inflated and the spare tire is not in use but the light remains on, contact your authorized dealer as soon as possible.
	Tire rotation without sensor training	On vehicles with different front and rear tire pressures, the system must be retrained following every tire rotation. See Tire Pressure Monitoring System Reset procedure later in this section.
Flashing warning light	Spare tire in use	Repair the damaged road wheel and tire assembly and reinstall it on the vehicle to restore system function. For a description on how the system functions, see When Your Temporary Spare Tire is Installed in this section.
	TPMS malfunction	If the tires are properly inflated and the spare tire is not in use but the light remains on, contact your authorized dealer as soon as possible.

Wheels and Tires

When Inflating Your Tires



WARNING: Do not use the tire pressure displayed in the information display as a tire pressure gauge. Failure to follow this instruction could result in personal injury or death.

When putting air into your tires (such as at a gas station or in your garage), the tire pressure monitoring system may not respond immediately to the air added to your tires.

It may take up to two minutes of driving over 20 mph (32 km/h) for the light to turn off after you have filled your tires to the recommended inflation pressure.

How Temperature Affects Your Tire Pressure

The tire pressure monitoring system monitors tire pressure in each pneumatic tire. While driving in a normal manner, a typical passenger tire inflation pressure may increase about 2–4 psi (14–28 kPa) from a cold start situation. If the vehicle is stationary overnight with the outside temperature significantly lower than the daytime temperature, the tire pressure may decrease about 3 psi (21 kPa) for a drop of 30°F (17°C) in ambient temperature. This lower pressure value may be detected by the tire pressure monitoring system as being significantly lower than the recommended inflation pressure and activate the system warning light for low tire pressure. If the low tire pressure warning light is on, visually check each tire to verify that no tire is flat. If one or more tires are flat, repair as necessary. Check the air pressure in the road tires. If any tire is under-inflated, carefully drive the vehicle to the nearest location where air can be added to the tires. Inflate all the tires to the recommended inflation pressure.

Tire Pressure Monitoring System Reset Procedure



WARNING: To determine the required pressure(s) for your vehicle, see the Safety Compliance Certification Label (on the door hinge pillar, door-latch post or the door edge that meets the door-latch post, next to the driver seat) or the Tire Label on the B-Pillar or the edge of the driver door.

Note: You need to perform the tire pressure monitoring system reset procedure after each tire rotation.

To provide the vehicle's load carrying capability, some vehicles require different recommended tire pressures in the front tires as compared to the rear tires. The tire pressure monitoring system equipped on these vehicles is designed to illuminate the low tire pressure warning light at two different pressures; one for the front tires and one for the rear tires.

Since tires need to be rotated to provide consistent performance and maximum tire life, the tire pressure monitoring system needs to know when the tires are rotated to determine which set of tires are on the front and which are on the rear. With this information, the system can detect and properly warn of low tire pressures.

System reset tips:

Wheels and Tires

- To reduce the chances of interference from another vehicle, perform the system reset procedure at least 3 ft (1 m) away from another Ford Motor Company vehicle undergoing the system reset procedure at the same time.
 - Do not wait more than two minutes between resetting each tire sensor or the system can time-out and you have to repeat the entire procedure on all four wheels.
 - A double horn sounds indicating the need to repeat the procedure.
5. Train the tire pressure monitoring system sensors in the tires using the following system reset sequence starting with the left front tire in the following clockwise order: Left front - driver side front tire, Right front - passenger side front tire, Right rear - passenger side rear tire, Left rear - driver side rear tire.
 6. Remove the valve cap from the valve stem on the left front tire. Decrease the air pressure until the horn sounds.

Note: *The single horn tone confirms that the sensor identification code has been learned by the module for this position. If a double horn is heard, the reset procedure was unsuccessful, and you must repeat it.*

Performing the System Reset Procedure

Read the entire procedure before attempting.

1. Drive the vehicle above 20 mph (32 km/h) for at least two minutes, then park in a safe location where you can easily get to all four tires and have access to an air pump.
2. Place the ignition in the off position and keep the key in the ignition.
3. Cycle the ignition to the on position with the engine off.
4. Turn the hazard flashers on then off three times. You must accomplish this within 10 seconds. If you successfully enter the reset mode, the horn sounds once, the system indicator flashes and a message shows in the information display. If this does not occur, please try again starting at step 2. If after repeated attempts to enter the reset mode, the horn does not sound, the system indicator does not flash and no message shows in the information display, seek service from your authorized dealer.
7. Remove the valve cap from the valve stem on the right front tire. Decrease the air pressure until the horn sounds.
8. Remove the valve cap from the valve stem on the right rear tire. Decrease the air pressure until the horn sounds.
9. Remove the valve cap from the valve stem on the left rear tire. Decrease the air pressure until the horn sounds. Training is complete after the horn sounds for the last tire trained, driver side rear tire, the system indicator stops flashing, and a message shows in the information display.
10. Turn the ignition off. If two short horn beeps are heard, the reset procedure was unsuccessful and you must repeat it. If after repeating the procedure and two short beeps are heard when the ignition is turned to off, seek assistance from your authorized dealer.

Wheels and Tires

11. Set all four tires to the recommended air pressure as indicated on the Safety Compliance Certification Label, affixed to either the door hinge pillar, door-latch post, or the door edge that meets the door-latch post, next to the driver seating position or Tire Label located on the B-Pillar or the edge of the driver door.

CHANGING A ROAD WHEEL



WARNING: If the tire pressure monitor sensor becomes damaged it may not function.

Note: You should only use tire sealants in roadside emergencies as they may cause damage to the tire pressure monitoring system sensor.

Note: The tire pressure monitoring system indicator light illuminates when the spare tire is in use. To restore the full function of the monitoring system, all road wheels equipped with tire pressure monitoring sensors must be mounted on the vehicle.

If you get a flat tire when driving, do not apply the brake heavily. Instead, gradually decrease your speed. Hold the steering wheel firmly and slowly move to a safe place on the side of the road.

Have a flat serviced by an authorized dealer in order to prevent damage to the tire pressure monitoring system sensors. See **Tire Pressure Monitoring System** (page 364). Replace the spare tire with a road tire as soon as possible. During repairing or replacing of the flat tire, have the authorized dealer inspect the tire pressure monitoring system sensor for damage.

Dissimilar Spare Wheel and Tire Assembly Information



WARNING: Failure to follow these guidelines could result in an increased risk of loss of vehicle control, injury or death.

If you have a dissimilar spare wheel and tire, then it is intended for temporary use only. This means that if you need to use it, you should replace it as soon as possible with a road wheel and tire assembly that is the same size and type as the road tires and wheels that were originally provided by us. If the dissimilar spare tire or wheel is damaged, you should replace it rather than repair it.

A dissimilar spare wheel and tire assembly is defined as a spare wheel and tire assembly that is different in brand, size or appearance from the road tires and wheels and can be one of three types:

1. **T-type mini-spare:** This spare tire begins with the letter T for tire size and may have Temporary Use Only molded in the sidewall.
2. **Full-size dissimilar spare with label on wheel:** This spare tire has a label on the wheel that states: THIS WHEEL AND TIRE ASSEMBLY FOR TEMPORARY USE ONLY.

When driving with one of the dissimilar spare tires listed above, do not:

- Exceed 50 mph (80 km/h).
- Load the vehicle beyond maximum vehicle load rating listed on the Safety Compliance Label.
- Tow a trailer.
- Use snow chains on the end of the vehicle with the dissimilar spare tire.
- Use more than one dissimilar spare tire at a time.

Wheels and Tires

- Use commercial car washing equipment.
- Try to repair the dissimilar spare tire.

Use of one of the dissimilar spare tires listed above at any one wheel location can lead to impairment of the following:

- Handling, stability and braking performance.
- Comfort and noise.
- Ground clearance and parking at curbs.
- Winter weather driving capability.
- Wet weather driving capability.
- Four-wheel driving capability.

3. Full-size dissimilar spare without label on wheel.

When driving with the full-size dissimilar spare wheel and tire assembly, do not:

- Exceed 70 mph (113 km/h).
- Use more than one dissimilar spare wheel and tire assembly at a time.
- Use commercial car washing equipment.
- Use snow chains on the end of the vehicle with the dissimilar spare wheel and tire assembly.

The usage of a full-size dissimilar spare wheel and tire assembly can lead to impairment of the following:

- Handling, stability and braking performance.
- Comfort and noise.
- Ground clearance and parking at curbs.
- Winter weather driving capability.
- Wet weather driving capability.
- Four-wheel driving capability.

When driving with the full-size dissimilar spare wheel and tire assembly additional caution should be given to:

- Towing a trailer.
- Driving vehicles equipped with a camper body.
- Driving vehicles with a load on the cargo rack.

Drive cautiously when using a full-size dissimilar spare wheel and tire assembly and seek service as soon as possible.

Tire Change Procedure



WARNING: The jack supplied with this vehicle is only intended for changing wheels. Do not use the vehicle jack other than when you are changing a wheel in an emergency.



WARNING: Check that the vehicle jack is not damaged or deformed and the thread is lubricated and clean.



WARNING: To help prevent your vehicle from moving when changing a wheel, shift the transmission into park (P), set the parking brake and use an appropriate block or wheel chock to secure the wheel diagonally opposite to the wheel being changed. For example, when changing the front left wheel, place an appropriate block or wheel chock on the right rear wheel.



WARNING: Always use the jack provided as original equipment with your vehicle. If using a jack other than the one provided, make sure the jack capacity is adequate for the vehicle weight, including any vehicle cargo or modifications. If you are unsure if the jack capacity is adequate, contact the authorized dealer.

Wheels and Tires

WARNING: Do not work on your vehicle when the jack is the only support as your vehicle could slip off the jack. Failure to follow this instruction could result in personal injury or death.

WARNING: Use only the specified jacking points. If you use other positions, you may damage the body, steering, suspension, engine, braking system or the fuel lines.

WARNING: Never place anything between the vehicle jack and your vehicle.

WARNING: Never place anything between the vehicle jack and the ground.

WARNING: Park your vehicle so that you do not obstruct the flow of traffic or place yourself in any danger and set up a warning triangle.

WARNING: Do not attempt to change a tire on the side of the vehicle close to moving traffic. Pull far enough off the road to avoid the danger of being hit when operating the jack or changing the wheel.

Note: Passengers should not remain in your vehicle when the vehicle is being jacked.

Note: Jack at the specified locations to avoid damage to the vehicle.

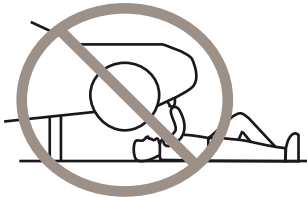

Note: No maintenance or additional lubrication of your jack is required over the service life of your vehicle.

1. Park on a level surface, set the parking brake and switch on the hazard flashers.
2. Apply the parking brake, place the transmission in park (P) or reverse (R) for manual transmission. Turn the engine off.
3. If your vehicle has air suspension, use the touch screen to switch on the Air Suspension Service Mode prior to jacking.

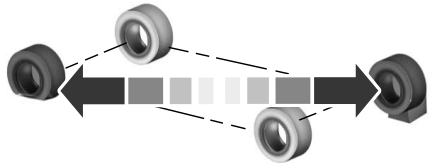

4. Block the wheel diagonally opposite the flat tire. For example, if the left front tire is flat, block the right rear wheel.

Wheels and Tires



5. Unfold the third row seat if it is in the stowed position, then remove the carpeted cargo area to access the spare tire and jack storage compartment.
6. Turn the wing nut securing the spare tire counterclockwise, remove the wing nut.
7. Remove the spare tire, jack and wrench from the spare tire storage compartment.

8. Turn the hex nut on the jack counterclockwise to remove the lug wrench from jack. This lowers the jack and loosens the mechanical lock.



9. Unfold the wrench for use.

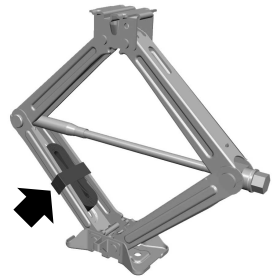

10. Remove the strap from the jack.

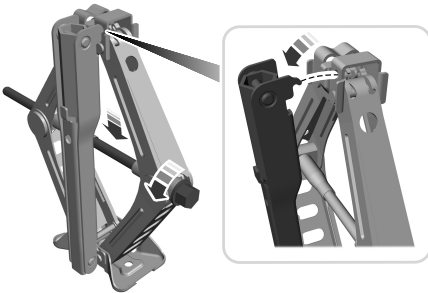

Wheels and Tires

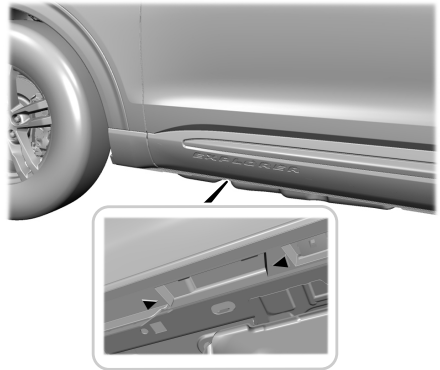
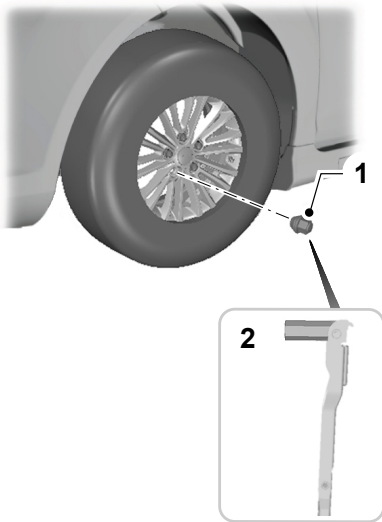

11. Loosen each wheel lug nut one-half turn counterclockwise, but do not remove them until the flat tire is raised off the ground.



12. Find the jacking points shown here, small arrow-shaped marks on the sills show the location of the jacking points.

13. Place the jack at the jacking point next to the tire which you are changing. Turn the lug wrench handle clockwise until the flat tire is completely off the ground.



14. Remove the lug nuts with the lug wrench.
15. Replace the flat tire with the spare tire, making sure the valve stem is facing outward.
16. Install the lug nuts snug against the hub. Do not fully tighten the lug nuts until the vehicle is lowered.
17. Turn the wrench handle counterclockwise to lower the vehicle completely.

Wheels and Tires

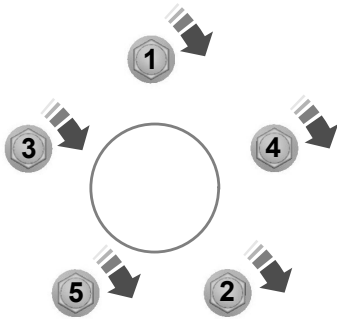

18. Remove the jack and fully tighten the lug nuts in the order shown. See **Technical Specifications** (page 376).
19. If you enabled the Air Suspension Service Mode, switch the mode off prior to driving.
20. Remove the wheel blocks.

Stowing the jack

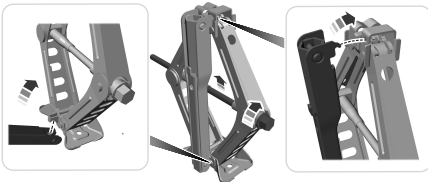

1. To store the folded wrench on the jack, engage the bracket of the jack base and the lug wrench pin, swing the wrench upwards, adjust jack height until the wrench hook engages the hole on jack. Tighten the hex nut clockwise by hand until secure.
2. Place the jack in the spare tire compartment, install the wing nut and tighten clockwise by hand until secure.

Stowing the flat tire

You cannot store the full-sized road wheel in the temporary spare tire well.

1. Find the flat tire retainer strap tucked inside the jack channel. Lower the carpeted load floor.
2. Stow the flat tire in the cargo area on the load floor with the wheel facing up. Secure the flat tire with the retainer strap by following the next steps.

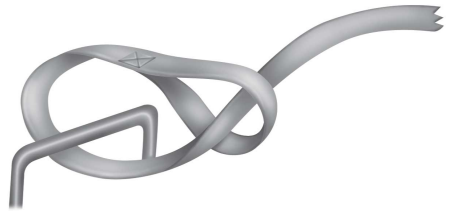

3. Locate the rear left side and right side cargo tie-down rings. Push the loop end of the retainer strap through one cargo tie-down ring. Thread the non-loop end through the loop.
4. Weave the retainer strap through the wheel openings.

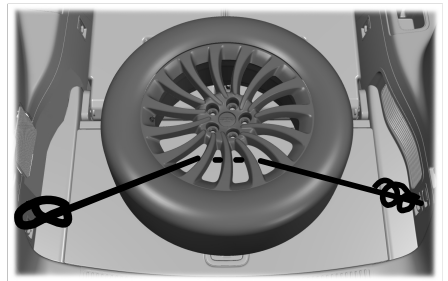

Wheels and Tires

5. Locate the front cargo tie-down in the opposite rear corner of the cargo area. Thread the retainer strap through the tie-down and pull tight.

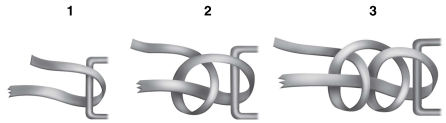

6. Secure by tying a 2-half hitch knot.

TECHNICAL SPECIFICATIONS

Wheel Lug Nut Torque Specifications



WARNING: When you install a wheel, always remove any corrosion, dirt or foreign materials present on the mounting surfaces of the wheel or the surface of the wheel hub, brake drum or brake disc that contacts the wheel. Make sure to secure any fasteners that attach the rotor to the hub so they do not interfere with the mounting surfaces of the wheel. Installing wheels without correct metal-to-metal contact at the wheel mounting surfaces can cause the wheel nuts to loosen and the wheel to come off while your vehicle is in motion, resulting in loss of vehicle control, personal injury or death.

Bolt size	lb.ft (Nm) *
M14 x 1.5	150 lb.ft (204 Nm)

*Torque specifications are for nut and bolt threads free of dirt and rust. Use only our recommended replacement fasteners.

Retighten the lug nuts to the specified torque within 100 miles (160 kilometers) after any wheel disturbance (such as tire rotation, changing a flat tire, wheel removal).

Wheels and Tires



A Wheel pilot bore

Inspect the wheel pilot bore and mounting surface prior to installation. Remove any visible corrosion or loose particles.

Capacities and Specifications

ENGINE SPECIFICATIONS - 2.3L ECOBOOST™

Engine	2.3L EcoBoost
Compression ratio.	10:1
Displacement.	138 in ³ (2,261 cm ³)
Firing order.	1-3-4-2
Ignition system.	Coil on plug
Spark plug gap.	0.028–0.031 in (0.7–0.8 mm)

Drivebelt Routing

2.3L EcoBoost Engine

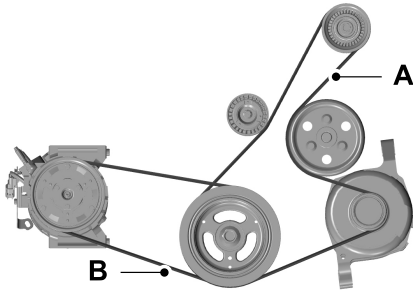

- A. Long drivebelt is on first pulley groove closest to engine.
- B. Short drivebelt is on second pulley groove farthest from engine.

ENGINE SPECIFICATIONS - 3.0L, ST

Item	Description
Configuration.	60 degree V6
Bore x stroke.	3.36 in (85.4 mm) bore x 3.39 in (86 mm) stroke
Displacement.	180 in ³ (2,956 cm ³)

Capacities and Specifications

Item	Description
Compression ratio.	9.5:1
Firing order.	1-4-2-5-3-6
Spark plug gap.	0.028–0.031 in (0.7–0.8 mm)
Horsepower.	400 hp ¹
Torque.	415 lb.ft ¹
Redline.	6500 RPM
Valvetrain.	Overhead cam - roller finger followers
Ignition.	Coil on plug
Throttle body.	2.4 in (60 mm)
Pistons.	Cast aluminum
Crankshaft.	Forged steel
Connecting rods.	Forged steel
Induction.	Twin turbocharged
Maximum Boost.	18.0 psi (124 kPa)
Exhaust system.	Dual 2.16 in (55 mm) exhaust with quad 3 in (76 mm) chrome tips

¹ When using premium fuel.

Drivebelt Routing

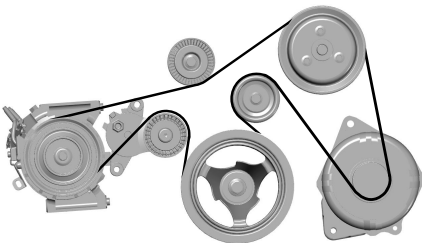

Capacities and Specifications

ENGINE SPECIFICATIONS - 3.0L

Engine	3.0L
Compression ratio.	9.5:1
Displacement.	180 in ³ (2,956 cm ³)
Firing order.	1-4-2-5-3-6
Ignition system.	Coil on plug
Spark plug gap.	0.028–0.031 in (0.7–0.8 mm)

Drivebelt Routing

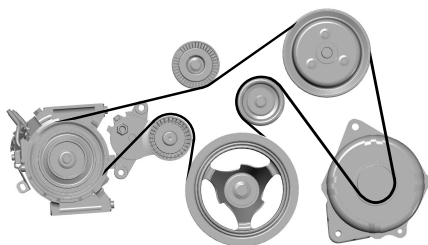

ENGINE SPECIFICATIONS - 3.3L, GASOLINE

Engine	3.3L
Compression ratio.	12.0:1
Displacement.	204 in ³ (3,340 cm ³)
Firing order.	1-4-2-5-3-6
Ignition system.	Coil on plug
Spark plug gap.	0.049–0.053 in (1.25–1.35 mm)

Capacities and Specifications

Drivebelt Routing

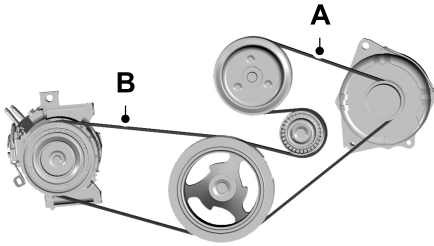

- A. Long drivebelt is on second pulley groove farthest from engine.
- B. Short drivebelt is on first pulley groove closest to engine.

ENGINE SPECIFICATIONS - 3.3L, HYBRID ELECTRIC VEHICLE (HEV)

Engine	3.3L HEV
Compression ratio.	12.0:1
Displacement.	204 in ³ (3,340 cm ³)
Firing order.	1-4-2-5-3-6
Ignition system.	Coil on plug
Spark plug gap.	0.049–0.053 in (1.25–1.35 mm)

Drivebelt Routing

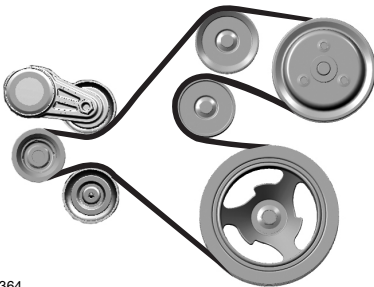

E291364

Capacities and Specifications

MOTORCRAFT PARTS - 2.3L ECOBOOST™

Component	Motorcraft Part Number
Air filter element.	FA-1884
Battery.	BAGM-48H6-760
Cabin air filter.	FP-100
Engine oil filter. ¹	FL-910-S
Spark plug.	SP-594
Rear window wiper blade.	WW-1110
Windshield wiper blade.	WW-2616 (driver side) WW-2113 (passenger side)

¹ If a Motorcraft oil filter is not available, use an oil filter that meets industry performance specification SAE/USCAR-36.

We recommend Motorcraft parts that are available at your authorized dealer or at www.fordparts.com. We engineer these parts for your vehicle to meet or exceed our specifications. Use of other parts could impact vehicle performance, emissions and durability. Your warranty could be void for any damage related to use of other parts.

MOTORCRAFT PARTS - 3.0L

Component	Motorcraft Part Number
Air filter element.	FA-1884
Battery.	BAGM-48H6-760
Cabin air filter.	FP-100
Engine oil filter. ¹	FL-2062-A
Spark plug.	SP-594
Rear window wiper blade.	WW-1110
Windshield wiper blade.	WW-2616 (driver side)

Capacities and Specifications

Component	Motorcraft Part Number
	WW-2113 (passenger side)

¹ If a Motorcraft oil filter is not available, use an oil filter that meets industry performance specification SAE/USCAR-36.

We recommend Motorcraft parts that are available at your authorized dealer or at www.fordparts.com. We engineer these parts for your vehicle to meet or exceed our specifications. Use of other parts could impact vehicle performance, emissions and durability. Your warranty could be void for any damage related to use of other parts.

MOTORCRAFT PARTS - 3.3L

Component	Motorcraft Part Number
Air filter element.	FA-1947
Battery.	BAGM-48H6-760
Cabin air filter.	FP-100
Engine oil filter. ¹	FL-500-S
Spark plug.	SP-520
Rear window wiper blade.	WW-1110
Windshield wiper blade.	WW-2616 (driver side) WW-2113 (passenger side)

¹ If a Motorcraft oil filter is not available, use an oil filter that meets industry performance specification SAE/USCAR-36.

We recommend Motorcraft parts that are available at your authorized dealer or at www.fordparts.com. We engineer these parts for your vehicle to meet or exceed our specifications. Use of other parts could impact vehicle performance, emissions and durability. Your warranty could be void for any damage related to use of other parts.

VEHICLE IDENTIFICATION NUMBER

The vehicle identification number is on the left-hand side of the instrument panel.

Capacities and Specifications

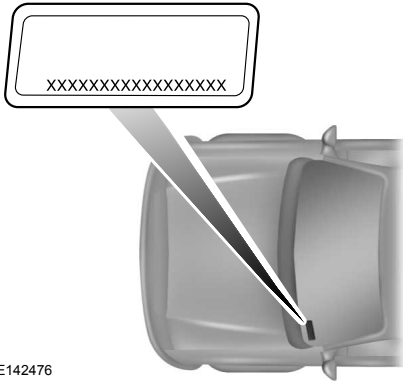

- C Make, vehicle line, series, body type.
- D Engine type.
- E Check digit.
- F Model year.
- G Assembly plant.
- H Production sequence number.

CAPACITIES AND SPECIFICATIONS - 2.3L ECOBOOST™

Use oil and fluid that meets the defined specification and viscosity grade.

If you do not use oil and fluid that meets the defined specification and viscosity grade, it could result in:

- Component damage that your vehicle warranty does not cover.
- Longer engine cranking periods.
- Increased emission levels.
- Reduced engine performance.
- Reduced fuel economy.
- Reduced brake performance.

Air Conditioning System



WARNING: The air conditioning refrigerant system contains refrigerant under high pressure. Only qualified personnel should service the air conditioning refrigerant system. Opening the air conditioning refrigerant system can cause personal injury.

E142476

Please note that in the graphic, XXXX is representative of your vehicle identification number.

The Vehicle Identification Number contains the following information:

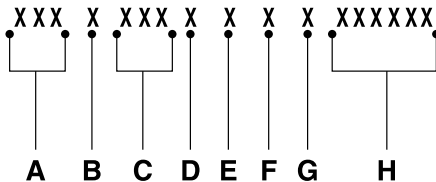

- A World manufacturer identifier.
- B Brake system, Gross Vehicle Weight Rating, Restraint Devices and their locations.

Capacities

Variant	Refrigerant	Refrigerant Oil
All.	35 oz (0.99 kg)	5.41 fl oz (160 ml)

Capacities and Specifications

Materials

Name	Specification
R-1234yf Refrigerant(U.S.) R-1234yf Refrigerant / Frigorigène R-1234yf(Canada) YN-33-A(U.S.) HS7Z-19B519-BA(Canada)	WSS-M17B21-A
Motorcraft® R-1234yf Refrigerant PAG Oil(U.S.) Motorcraft® R-1234yf Refrigerant PAG Oil / Huile PAG pour frigorigène R-1234yf Motorcraft®(Canada) YN-35(U.S. & Canada)	WSS-M2C300-A2

Automatic Transmission

Note: Only use MERCON® ULV transmission fluid for automatic transmissions that require MERCON® ULV transmission fluid. The use of any other fluid could cause transmission damage.

Capacities

Variante	Quantity
All.	12.6 qt (11.9 L) ¹

¹ Approximate dry fill capacity. Actual amount could vary during fluid changes.

Materials

Name	Specification
Motorcraft® MERCON® ULV Automatic Transmission Fluid(U.S.) Motorcraft® MERCON® ULV Automatic Transmission Fluid / MERCON® ULV huile pour boîtes automatique Motorcraft®(Canada) XT-12-QULV(U.S. & Canada)	WSS-M2C949-A, MERCON® ULV

Capacities and Specifications

Engine Coolant

Capacities

Variant	Quantity
Without trailer towing.	14.1 qt (13.3 L)
With trailer towing.	15.2 qt (14.4 L)

Materials

Name	Specification
Motorcraft® Yellow Prediluted Antifreeze/ Coolant(U.S.) Motorcraft® Yellow Prediluted Antifreeze/Coolant / Antigel/liquide de refroidissement prédilué jaune Motorcraft®(Canada) VC-13DL-G(U.S.) CVC-13DL-G(Canada)	WSS-M97B57-A2

Engine Oil



An oil that displays this symbol conforms to current engine, emission system and fuel economy performance standards of ILSAC.

We recommend Motorcraft® motor oil for your vehicle. If Motorcraft® oil is not available, use motor oils of the recommended viscosity grade that display the API Certification Mark for gasoline engines.

Do not use supplemental engine oil additives because they are unnecessary and could lead to engine damage that your vehicle warranty does not cover.

Capacities

Variant	Including the Oil Filter
All.	5.2 qt (4.9 L)

Capacities and Specifications

Materials

Name	Specification
Motorcraft® SAE 5W-30 Synthetic Blend Motor Oil(U.S.) Motorcraft® SAE 5W-30 Super Premium Motor Oil / Huile moteur de très haute qualité SAE 5W-30 Motorcraft®(Canada) XO-5W30-Q1SP(U.S.) CXO-5W30-LSP6(Canada)	WSS-M2C961-A1

Alternative Engine Oil for Extremely Cold Climates

To improve engine cold start performance, we recommend that you use the following alternative engine oil in extremely cold climates, where the ambient temperature reaches -22°F (-30°C) or below.

Materials

Name	Specification
Engine Oil - SAE 0W-30 - Synthetic Blend	WSS-M2C963-A1

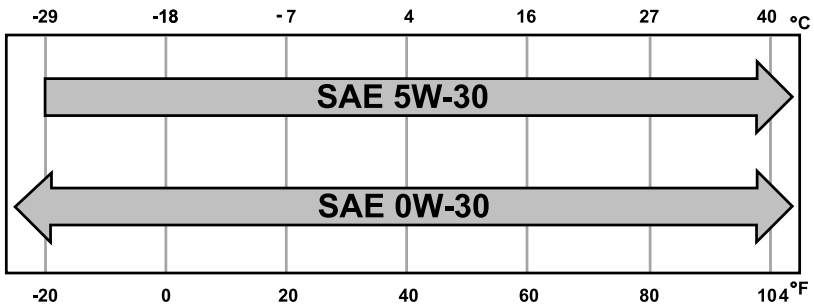

Capacities and Specifications

Note: If you use your vehicle regularly above the altitude of 7,500 ft (2,286 m) and under the temperature of -4.0°F (-20°C), it is recommended to use the alternative engine oil.

Fuel Tank

Capacities

Variant	Quantity
All.	17.9 gal (67.8 L)

Grease

Materials

Name	Specification
Motorcraft® Premium Long-Life Grease(U.S.) Motorcraft® Premium Long-Life Grease / Graisse longue durée de qualité première Motorcraft®(Canada) XG-1-E1(U.S. & Canada)	ESA-M1C75-B
Motorcraft® Multi-Purpose Grease Spray(U.S.) Motorcraft® Multi-Purpose Grease Spray / Graisse tout usage en aérosol Motorcraft®(Canada) XL-5-A(U.S. & Canada)	ESB-M1C93-B

Hydraulic Brake System

Materials

Name	Specification
Motorcraft® DOT 4 LV High Performance Motor Vehicle Brake Fluid(U.S.) Motorcraft® DOT 4 LV High Performance Motor Vehicle Brake Fluid / Liquide de frein automobile haute performance DOT 4 LV Motorcraft®(Canada) PM-20(U.S. & Canada)	WSS-M6C65-A2

Capacities and Specifications

Note: We recommend using DOT 4 Low Viscosity (LV) High Performance Brake Fluid or equivalent meeting WSS-M6C65-A2. Use of any fluid other than the recommended fluid could cause reduced brake performance and not meet our performance standards. Keep brake fluid clean and dry. Contamination with dirt, water, petroleum products or other materials could result in brake system damage and possible failure.

Locks

Materials

Name	Specification
Motorcraft® Penetrating and Lock Lubricant(U.S.) Motorcraft® Penetrating Fluid / Liquide dégrissant Motorcraft®(Canada) XL-1(U.S.) CXC-51-A(Canada)	-

Transfer Case

Capacities

Variant	Quantity
Four-wheel drive.	1.1 qt (1 L)

Materials

Name	Specification
Motorcraft® MERCON® LV Automatic Transmission Fluid(U.S.) Motorcraft® MERCON® LV Automatic Transmission Fluid / Huile pour boîte automatique MERCON® LV Motorcraft®(Canada) XT-10-QLVC(U.S.) CXT-10-LV6(Canada)	WSS-M2C938-AMERCON® LV,

Capacities and Specifications

Front Axle

Capacities

Variant	Quantity
Four-wheel drive.	0.6 qt (0.6 L)

Materials

Name	Specification
Motorcraft® SAE 75W-140 Synthetic Rear Axle Lubricant(U.S.) Motorcraft® SAE 75W-140 Synthetic Rear Axle Lubricant / Lubrifiant synthétique pour pont arrière SAE 75W-140 Motorcraft®(Canada) XY-75W140-QL(U.S.) CXY-75W140-1L(Canada)	WSL-M2C192-A

Rear Axle

Capacities

Variant	Quantity
Two-wheel drive.	1.9 qt (1.8 L)
Four-wheel drive.	1.7 qt (1.6 L)

Materials

Name	Specification
Motorcraft® SAE 75W-85 Premium Synthetic Hypoid Gear Lubricant(U.S.) Motorcraft® SAE 75W-85 Premium Synthetic Hypoid Gear Lubricant / Huile synthétique de haute qualité pour engrenages hypoides SAE 75W-85 Motorcraft®(Canada) XY-75W85-QL(U.S. & Canada)	WSS-M2C942-A

Capacities and Specifications

Washer Reservoir

Capacities

Variant	Quantity
All.	Fill as required.

Materials

Name	Specification
Motorcraft® Premium Windshield Wash Concentrate with Bitterant (U.S.) Motorcraft® Premium Quality Windshield Washer Fluid / Liquide lave-glacé de haute qualité Motorcraft® (Canada) ZC-32-B2 (U.S.) CXC-37-F/M (Canada)	WSS-M14P19-A

CAPACITIES AND SPECIFICATIONS - 3.0L

Use oil and fluid that meets the defined specification and viscosity grade.

If you do not use oil and fluid that meets the defined specification and viscosity grade, it could result in:

- Component damage that your vehicle warranty does not cover.
- Longer engine cranking periods.
- Increased emission levels.

- Reduced engine performance.
- Reduced fuel economy.
- Reduced brake performance.

Air Conditioning System

 **WARNING:** The air conditioning refrigerant system contains refrigerant under high pressure. Only qualified personnel should service the air conditioning refrigerant system. Opening the air conditioning refrigerant system can cause personal injury.

Capacities

Variant	Refrigerant	Refrigerant Oil
With rear air conditioning.	35 oz (0.99 kg)	5.41 fl oz (160 ml)
Without rear air conditioning.	24 oz (0.68 kg)	3.04 fl oz (90 ml)

Capacities and Specifications

Materials

Name	Specification
R-1234yf Refrigerant(U.S.) R-1234yf Refrigerant / Frigorigène R-1234yf(Canada) YN-33-A(U.S.) HS7Z-19B519-BA(Canada)	WSS-M17B21-A
Motorcraft® R-1234yf Refrigerant PAG Oil(U.S.) Motorcraft® R-1234yf Refrigerant PAG Oil / Huile PAG pour frigorigène R-1234yf Motorcraft®(Canada) YN-35(U.S. & Canada)	WSS-M2C300-A2

Automatic Transmission

Note: Only use MERCON® ULV transmission fluid for automatic transmissions that require MERCON® ULV transmission fluid. The use of any other fluid could cause transmission damage.

Capacities

Variant	Quantity
All.	12.6 qt (11.9 L) ¹

¹ Approximate dry fill capacity. Actual amount could vary during fluid changes.

Materials

Name	Specification
Motorcraft® MERCON® ULV Automatic Transmission Fluid(U.S.) Motorcraft® MERCON® ULV Automatic Transmission Fluid / MERCON® ULV huile pour boîtes automatique Motorcraft®(Canada) XT-12-QULV(U.S. & Canada)	WSS-M2C949-A, MERCON® ULV

Capacities and Specifications

Engine Coolant

Capacities

Variant	Quantity
With rear heat.	18.0 qt (17 L)
Without rear heat.	15.5 qt (14.7 L)

Materials

Name	Specification
Motorcraft® Yellow Prediluted Antifreeze/ Coolant (U.S.) Motorcraft® Yellow Prediluted Antifreeze/Coolant / Antigel/liquide de refroidissement prédilué jaune Motorcraft® (Canada) VC-13DL-G (U.S.) CVC-13DL-G (Canada)	WSS-M97B57-A2

Engine Oil



An oil that displays this symbol conforms to current engine, emission system and fuel economy performance standards of ILSAC.

We recommend Motorcraft® motor oil for your vehicle. If Motorcraft® oil is not available, use motor oils of the recommended viscosity grade that display the API Certification Mark for gasoline engines.

Do not use supplemental engine oil additives because they are unnecessary and could lead to engine damage that your vehicle warranty does not cover.

Capacities

Variant	Including the Oil Filter
All.	6.0 qt (5.7 L)

Capacities and Specifications

Materials

Name	Specification
Motorcraft® SAE 5W-30 Synthetic Blend Motor Oil(U.S.) Motorcraft® SAE 5W-30 Super Premium Motor Oil / Huile moteur de très haute qualité SAE 5W-30 Motorcraft®(Canada) XO-5W30-Q1SP(U.S.) CXO-5W30-LSP6(Canada)	WSS-M2C961-A1

Alternative Engine Oil for Extremely Cold Climates

To improve engine cold start performance, we recommend that you use the following alternative engine oil in extremely cold climates, where the ambient temperature reaches -22°F (-30°C) or below.

Materials

Name	Specification
Engine Oil - SAE 0W-30 - Synthetic Blend	WSS-M2C963-A1

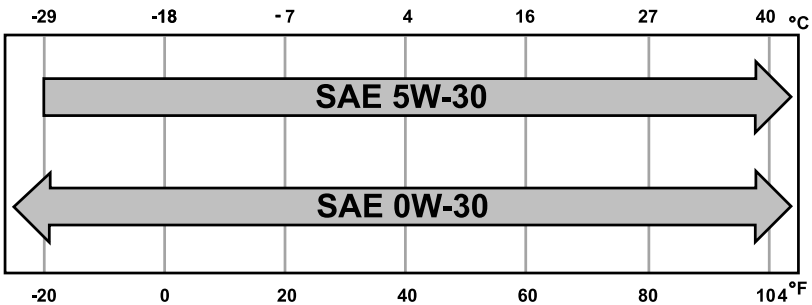

Capacities and Specifications

Note: *If you use your vehicle regularly above the altitude of 7,500 ft (2,286 m) and under the temperature of -4.0°F (-20°C), it is recommended to use the alternative engine oil.*

Fuel Tank

Capacities

Variant	Quantity
All.	20.2 gal (76.5 L)

Grease

Materials

Name	Specification
Motorcraft® Premium Long-Life Grease(U.S.) Motorcraft® Premium Long-Life Grease / Graisse longue durée de qualité première Motorcraft®(Canada) XG-1-E1(U.S. & Canada)	ESA-MIC75-B
Motorcraft® Multi-Purpose Grease Spray(U.S.) Motorcraft® Multi-Purpose Grease Spray / Graisse tout usage en aérosol Motorcraft®(Canada) XL-5-A(U.S. & Canada)	ESB-MIC93-B

Hydraulic Brake System

Materials

Name	Specification
Motorcraft® DOT 4 LV High Performance Motor Vehicle Brake Fluid(U.S.) Motorcraft® DOT 4 LV High Performance Motor Vehicle Brake Fluid / Liquide de frein automobile haute performance DOT 4 LV Motorcraft®(Canada) PM-20(U.S. & Canada)	WSS-M6C65-A2

Capacities and Specifications

Note: We recommend using DOT 4 Low Viscosity (LV) High Performance Brake Fluid or equivalent meeting WSS-M6C65-A2. Use of any fluid other than the recommended fluid could cause reduced brake performance and not meet our performance standards. Keep brake fluid clean and dry. Contamination with dirt, water, petroleum products or other materials could result in brake system damage and possible failure.

Locks

Materials

Name	Specification
Motorcraft® Penetrating and Lock Lubricant(U.S.) Motorcraft® Penetrating Fluid / Liquide dégrissant Motorcraft®(Canada) XL-1(U.S.) CXC-51-A(Canada)	-

Transfer Case

Capacities

Variant	Quantity
Four-wheel drive.	1.1 qt (1 L)

Materials

Name	Specification
Motorcraft® MERCON® LV Automatic Transmission Fluid(U.S.) Motorcraft® MERCON® LV Automatic Transmission Fluid / Huile pour boîte automatique MERCON® LV Motorcraft®(Canada) XT-10-QLVC(U.S.) CXT-10-LV6(Canada)	WSS-M2C938-AMERCON® LV,

Capacities and Specifications

Front Axle

Capacities

Variant	Quantity
Four-wheel drive.	0.6 qt (0.6 L)

Materials

Name	Specification
Motorcraft® SAE 75W-140 Synthetic Rear Axle Lubricant(U.S.) Motorcraft® SAE 75W-140 Synthetic Rear Axle Lubricant / Lubrifiant synthétique pour pont arrière SAE 75W-140 Motorcraft®(Canada) XY-75W140-QL(U.S.) CXY-75W140-1L(Canada)	WSL-M2C192-A

Rear Axle

Capacities

Variant	Quantity
All.	1.9 qt (1.8 L)

Materials

Name	Specification
Motorcraft® SAE 75W-85 Premium Synthetic Hypoid Gear Lubricant(U.S.) Motorcraft® SAE 75W-85 Premium Synthetic Hypoid Gear Lubricant / Huile synthétique de haute qualité pour engrenages hypoïdes SAE 75W-85 Motorcraft®(Canada) XY-75W85-QL(U.S. & Canada)	WSS-M2C942-A

Capacities and Specifications

Washer Reservoir

Capacities

Variant	Quantity
All.	Fill as required.

Materials

Name	Specification
Motorcraft® Premium Windshield Wash Concentrate with Bitterant (U.S.) Motorcraft® Premium Quality Windshield Washer Fluid / Liquide lave-glace de haute qualité Motorcraft® (Canada) ZC-32-B2 (U.S.) CXC-37-F/M (Canada)	WSS-M14P19-A

CAPACITIES AND SPECIFICATIONS - 3.3L, GASOLINE

Use oil and fluid that meets the defined specification and viscosity grade.

If you do not use oil and fluid that meets the defined specification and viscosity grade, it could result in:

- Component damage that your vehicle warranty does not cover.
- Longer engine cranking periods.

- Increased emission levels.
- Reduced engine performance.
- Reduced fuel economy.
- Reduced brake performance.

Air Conditioning System



WARNING: The air conditioning refrigerant system contains refrigerant under high pressure. Only qualified personnel should service the air conditioning refrigerant system. Opening the air conditioning refrigerant system can cause personal injury.

Capacities

Variant	Refrigerant	Refrigerant Oil
With rear air conditioning.	35 oz (0.99 kg)	5.41 fl oz (160 ml)
Without rear air conditioning.	24 oz (0.68 kg)	3.04 fl oz (90 ml)

Capacities and Specifications

Materials

Name	Specification
R-1234yf Refrigerant(U.S.) R-1234yf Refrigerant / Frigorigène R-1234yf(Canada) YN-33-A(U.S.) HS7Z-19B519-BA(Canada)	WSS-M17B21-A
Motorcraft® R-1234yf Refrigerant PAG Oil(U.S.) Motorcraft® R-1234yf Refrigerant PAG Oil / Huile PAG pour frigorigène R-1234yf Motorcraft®(Canada) YN-35(U.S. & Canada)	WSS-M2C300-A2

Automatic Transmission

Note: Only use MERCON® ULV transmission fluid for automatic transmissions that require MERCON® ULV transmission fluid. The use of any other fluid could cause transmission damage.

Capacities

Variante	Quantity
All.	12.6 qt (11.9 L) ¹

¹ Approximate dry fill capacity. Actual amount could vary during fluid changes.

Materials

Name	Specification
Motorcraft® MERCON® ULV Automatic Transmission Fluid(U.S.) Motorcraft® MERCON® ULV Automatic Transmission Fluid / MERCON® ULV huile pour boîtes automatique Motorcraft®(Canada) XT-12-QULV(U.S. & Canada)	WSS-M2C949-A, MERCON® ULV

Capacities and Specifications

Engine Coolant

Capacities

Variant	Quantity
With rear heat.	15.2 qt (14.4 L)
Without rear heat.	12.9 qt (12.2 L)

Materials

Name	Specification
Motorcraft® Yellow Prediluted Antifreeze/ Coolant(U.S.) Motorcraft® Yellow Prediluted Antifreeze/Coolant / Antigel/liquide de refroidissement prédilué jaune Motorcraft®(Canada) VC-13DL-G(U.S.) CVC-13DL-G(Canada)	WSS-M97B57-A2

Engine Oil



An oil that displays this symbol conforms to current engine, emission system and fuel economy performance standards of ILSAC.

We recommend Motorcraft® motor oil for your vehicle. If Motorcraft® oil is not available, use motor oils of the recommended viscosity grade that display the API Certification Mark for gasoline engines.

Do not use supplemental engine oil additives because they are unnecessary and could lead to engine damage that your vehicle warranty does not cover.

Capacities

Variant	Including the Oil Filter
All.	6.0 qt (5.7 L)

Capacities and Specifications

Materials

Name	Specification
Motorcraft® SAE 5W-20 Synthetic Blend Motor Oil(U.S.) Motorcraft® SAE 5W-20 Super Premium Motor Oil / Huile moteur de très haute qualité SAE 5W-20 Motorcraft®(Canada) XO-5W20-Q1SP(U.S.) CXO-5W20-LSP6(Canada)	WSS-M2C960-A1

Alternative Engine Oil for Extremely Cold Climates

To improve engine cold start performance, we recommend that you use the following alternative engine oil in extremely cold climates, where the ambient temperature reaches -22°F (-30°C) or below.

Materials

Name	Specification
Motorcraft® SAE 0W-20 Full Synthetic Motor Oil(U.S.) (Canada) XO-0W20-QFS(U.S.)	WSS-M2C962-A1

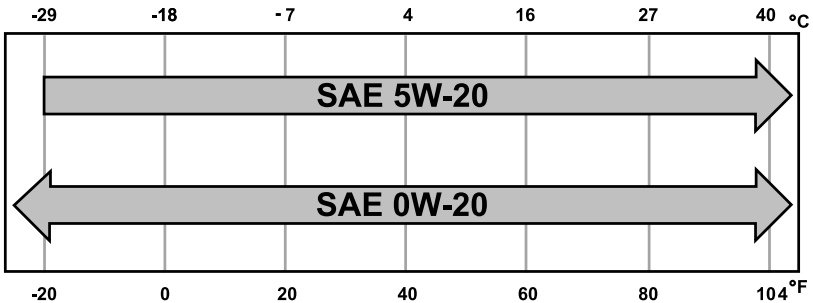

Capacities and Specifications

Note: If you use your vehicle regularly above the altitude of 7,500 ft (2,286 m) and under the temperature of -4.0°F (-20°C), it is recommended to use the alternative engine oil.

Fuel Tank

Capacities

Variant	Quantity
All.	20.2 gal (76.5 L)

Grease

Materials

Name	Specification
Motorcraft® Premium Long-Life Grease(U.S.) Motorcraft® Premium Long-Life Grease / Graisse longue durée de qualité première Motorcraft®(Canada) XG-1-E1(U.S. & Canada)	ESA-MIC75-B
Motorcraft® Multi-Purpose Grease Spray(U.S.) Motorcraft® Multi-Purpose Grease Spray / Graisse tout usage en aérosol Motorcraft®(Canada) XL-5-A(U.S. & Canada)	ESB-MIC93-B

Hydraulic Brake System

Materials

Name	Specification
Motorcraft® DOT 4 LV High Performance Motor Vehicle Brake Fluid(U.S.) Motorcraft® DOT 4 LV High Performance Motor Vehicle Brake Fluid / Liquide de frein automobile haute performance DOT 4 LV Motorcraft®(Canada) PM-20(U.S. & Canada)	WSS-M6C65-A2

Capacities and Specifications

Note: We recommend using DOT 4 Low Viscosity (LV) High Performance Brake Fluid or equivalent meeting WSS-M6C65-A2. Use of any fluid other than the recommended fluid could cause reduced brake performance and not meet our performance standards. Keep brake fluid clean and dry. Contamination with dirt, water, petroleum products or other materials could result in brake system damage and possible failure.

Locks

Materials

Name	Specification
Motorcraft® Penetrating and Lock Lubricant(U.S.) Motorcraft® Penetrating Fluid / Liquide dégrissant Motorcraft®(Canada) XL-1(U.S.) CXC-51-A(Canada)	-

Transfer Case

Capacities

Variant	Quantity
Four-wheel drive.	1.1 qt (1 L)

Materials

Name	Specification
Motorcraft® MERCON® LV Automatic Transmission Fluid(U.S.) Motorcraft® MERCON® LV Automatic Transmission Fluid / Huile pour boîte automatique MERCON® LV Motorcraft®(Canada) XT-10-QLVC(U.S.) CXT-10-LV6(Canada)	WSS-M2C938-AMERCON® LV,

Capacities and Specifications

Front Axle

Capacities

Variant	Quantity
Four-wheel drive.	0.6 qt (0.6 L)

Materials

Name	Specification
Motorcraft® SAE 75W-140 Synthetic Rear Axle Lubricant(U.S.) Motorcraft® SAE 75W-140 Synthetic Rear Axle Lubricant / Lubrifiant synthétique pour pont arrière SAE 75W-140 Motorcraft®(Canada) XY-75W140-QL(U.S.) CXY-75W140-1L(Canada)	WSL-M2C192-A

Rear Axle

Capacities

Variant	Quantity
All.	1.7 qt (1.6 L)

Materials

Name	Specification
Motorcraft® SAE 75W-85 Premium Synthetic Hypoid Gear Lubricant(U.S.) Motorcraft® SAE 75W-85 Premium Synthetic Hypoid Gear Lubricant / Huile synthétique de haute qualité pour engrenages hypoides SAE 75W-85 Motorcraft®(Canada) XY-75W85-QL(U.S. & Canada)	WSS-M2C942-A

Capacities and Specifications

Washer Reservoir

Capacities

Variant	Quantity
All.	Fill as required.

Materials

Name	Specification
Motorcraft® Premium Windshield Wash Concentrate with Bitterant (U.S.) Motorcraft® Premium Quality Windshield Washer Fluid / Liquide lave-glace de haute qualité Motorcraft® (Canada) ZC-32-B2 (U.S.) CXC-37-F/M (Canada)	WSS-M14P19-A

CAPACITIES AND SPECIFICATIONS - 3.3L, HYBRID ELECTRIC VEHICLE (HEV)

Use oil and fluid that meets the defined specification and viscosity grade.

If you do not use oil and fluid that meets the defined specification and viscosity grade, it could result in:

- Component damage that your vehicle warranty does not cover.
- Longer engine cranking periods.

- Increased emission levels.
- Reduced engine performance.
- Reduced fuel economy.
- Reduced brake performance.

Air Conditioning System



WARNING: The air conditioning refrigerant system contains refrigerant under high pressure. Only qualified personnel should service the air conditioning refrigerant system. Opening the air conditioning refrigerant system can cause personal injury.

Capacities

Variant	Refrigerant	Refrigerant Oil
With rear air conditioning.	35 oz (0.99 kg)	8.12 fl oz (240 ml)
Without rear air conditioning.	26 oz (0.74 kg)	5.41 fl oz (160 ml)

Capacities and Specifications

Materials

Name	Specification
R-1234yf Refrigerant(U.S.) R-1234yf Refrigerant / Frigorigène R-1234yf(Canada) YN-33-A(U.S.) HS7Z-19B519-BA(Canada)	WSS-M17B21-A
Motorcraft® R-1234yf Refrigerant POE Oil(U.S.) Motorcraft® R-1234yf Refrigerant POE Oil / Huile POE pour frigorigène R-1234yf Motorcraft®(Canada) YN-34(U.S. & Canada)	WSS-M2C31-B2

Automatic Transmission

Note: Only use MERCON® ULV transmission fluid for automatic transmissions that require MERCON® ULV transmission fluid. The use of any other fluid could cause transmission damage.

Capacities

Variant	Quantity
All.	13.7 qt (13 L) ¹

¹ Approximate dry fill capacity. Actual amount could vary during fluid changes.

Materials

Name	Specification
Motorcraft® MERCON® ULV Automatic Transmission Fluid(U.S.) Motorcraft® MERCON® ULV Automatic Transmission Fluid / MERCON® ULV huile pour boîtes automatique Motorcraft®(Canada) XT-12-QULV(U.S. & Canada)	WSS-M2C949-A, MERCON® ULV

Capacities and Specifications

Engine Coolant

Capacities

Variant	Quantity
With rear heat.	16.4 qt (15.5 L)
Without rear heat.	13.9 qt (13.2 L)
HEV low temperature cooling loop (battery and electric motor electronics).	4.6 qt (4.4 L)

Materials

Name	Specification
Motorcraft® Yellow Prediluted Antifreeze/ Coolant (U.S.) Motorcraft® Yellow Prediluted Antifreeze/Coolant / Antigel/liquide de refroidissement prédilué jaune Motorcraft® (Canada) VC-13DL-G (U.S.) CVC-13DL-G (Canada)	WSS-M97B57-A2

Engine Oil



An oil that displays this symbol conforms to current engine, emission system and fuel economy performance standards of ILSAC.

We recommend Motorcraft® motor oil for your vehicle. If Motorcraft® oil is not available, use motor oils of the recommended viscosity grade that display the API Certification Mark for gasoline engines.

Do not use supplemental engine oil additives because they are unnecessary and could lead to engine damage that your vehicle warranty does not cover.

Capacities

Variant	Including the Oil Filter
All.	6.0 qt (5.7 L)

Capacities and Specifications

Materials

Name	Specification
Motorcraft® SAE 5W-20 Synthetic Blend Motor Oil(U.S.) Motorcraft® SAE 5W-20 Super Premium Motor Oil / Huile moteur de très haute qualité SAE 5W-20 Motorcraft®(Canada) XO-5W20-Q1SP(U.S.) CXO-5W20-LSP6(Canada)	WSS-M2C960-A1

Alternative Engine Oil for Extremely Cold Climates

To improve engine cold start performance, we recommend that you use the following alternative engine oil in extremely cold climates, where the ambient temperature reaches -22°F (-30°C) or below.

Materials

Name	Specification
Motorcraft® SAE 0W-20 Full Synthetic Motor Oil(U.S.) (Canada) XO-0W20-QFS(U.S.)	WSS-M2C962-A1

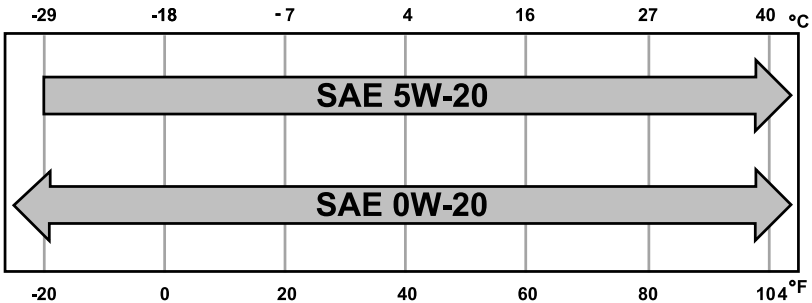

Capacities and Specifications

Note: *If you use your vehicle regularly above the altitude of 7,500 ft (2,286 m) and under the temperature of -4.0°F (-20°C), it is recommended to use the alternative engine oil.*

Fuel Tank

Capacities

Variant	Quantity
All.	18.0 gal (68.1 L)

Grease

Materials

Name	Specification
Motorcraft® Premium Long-Life Grease(U.S.) Motorcraft® Premium Long-Life Grease / Graisse longue durée de qualité première Motorcraft®(Canada) XG-1-E1(U.S. & Canada)	ESA-MIC75-B
Motorcraft® Multi-Purpose Grease Spray(U.S.) Motorcraft® Multi-Purpose Grease Spray / Graisse tout usage en aérosol Motorcraft®(Canada) XL-5-A(U.S. & Canada)	ESB-MIC93-B

Hydraulic Brake System

Materials

Name	Specification
Motorcraft® DOT 4 LV High Performance Motor Vehicle Brake Fluid(U.S.) Motorcraft® DOT 4 LV High Performance Motor Vehicle Brake Fluid / Liquide de frein automobile haute performance DOT 4 LV Motorcraft®(Canada) PM-20(U.S. & Canada)	WSS-M6C65-A2

Capacities and Specifications

Note: We recommend using DOT 4 Low Viscosity (LV) High Performance Brake Fluid or equivalent meeting WSS-M6C65-A2. Use of any fluid other than the recommended fluid could cause reduced brake performance and not meet our performance standards. Keep brake fluid clean and dry. Contamination with dirt, water, petroleum products or other materials could result in brake system damage and possible failure.

Locks

Materials

Name	Specification
Motorcraft® Penetrating and Lock Lubricant(U.S.) Motorcraft® Penetrating Fluid / Liquide dégrissant Motorcraft®(Canada) XL-1(U.S.) CXC-51-A(Canada)	-

Transfer Case

Capacities

Variant	Quantity
Four-wheel drive.	1.1 qt (1 L)

Materials

Name	Specification
Motorcraft® MERCON® LV Automatic Transmission Fluid(U.S.) Motorcraft® MERCON® LV Automatic Transmission Fluid / Huile pour boîte automatique MERCON® LV Motorcraft®(Canada) XT-10-QLVC(U.S.) CXT-10-LV6(Canada)	WSS-M2C938-AMERCON® LV,

Capacities and Specifications

Front Axle

Capacities

Variant	Quantity
Four-wheel drive.	0.6 qt (0.6 L)

Materials

Name	Specification
Motorcraft® SAE 75W-140 Synthetic Rear Axle Lubricant(U.S.) Motorcraft® SAE 75W-140 Synthetic Rear Axle Lubricant / Lubrifiant synthétique pour pont arrière SAE 75W-140 Motorcraft®(Canada) XY-75W140-QL(U.S.) CXY-75W140-1L(Canada)	WSL-M2C192-A

Rear Axle

Capacities

Variant	Quantity
All.	1.9 qt (1.8 L)

Materials

Name	Specification
Motorcraft® SAE 75W-85 Premium Synthetic Hypoid Gear Lubricant(U.S.) Motorcraft® SAE 75W-85 Premium Synthetic Hypoid Gear Lubricant / Huile synthétique de haute qualité pour engrenages hypoïdes SAE 75W-85 Motorcraft®(Canada) XY-75W85-QL(U.S. & Canada)	WSS-M2C942-A

Capacities and Specifications

Washer Reservoir

Capacities

Variant	Quantity
All.	Fill as required.

Materials

Name	Specification
Motorcraft® Premium Windshield Wash Concentrate with Bitterant(U.S.) Motorcraft® Premium Quality Windshield Washer Fluid / Liquide lave-glace de haute qualité Motorcraft®(Canada) ZC-32-B2(U.S.) CXC-37-F/M(Canada)	WSS-M14P19-A

BULB SPECIFICATION CHART

Replacement bulbs are specified in the chart below. Headlamp bulbs must be marked with an authorized D.O.T. marking for North America to make sure they have the proper lamp performance, light brightness, light pattern and safe visibility. The correct bulbs will not damage the lamp assembly or void the lamp assembly warranty and will provide quality bulb illumination time.

Exterior Lamps

Lamp	Specification	Power (Watt)
Front side marker lamps.	LED.	LED.
Front signature lamps.	LED.	LED.
Front direction indicator.	LED.	LED.
Daytime running lamps.	LED.	LED.
Headlamp low beam.	LED.	LED.

Capacities and Specifications

Lamp	Specification	Power (Watt)
Headlamp high beam.	LED.	LED.
Front fog lamps.	LED.	LED.
Side direction indicator.	LED.	LED.
Rear side marker lamp.	LED.	LED.
Brake and rear lamp.	LED.	LED.
Central high mounted brake lamp.	LED.	LED.
Rear direction indicator.	3757NAK, PY27/7W	27
Reversing lamps.	W21W	21
License plate lamp.	W5W	5

Note: LED lamps are not serviceable. See an authorized dealer if they fail.

Interior Lamps

Lamp	Specification	Power (Watt)
All interior lamps.	LED.	LED.

Note: LED lamps are not serviceable. See an authorized dealer if they fail.

Connected Vehicle

WHAT IS A CONNECTED VEHICLE

A connected vehicle has technology that allows your vehicle to connect to a mobile network and for you to access a range of features. When used in conjunction with the FordPass app, it could allow you to monitor and control your vehicle further, for example checking the tire pressures, the fuel level and the vehicle location. For additional information, refer to the local Ford website.

CONNECTED VEHICLE REQUIREMENTS

Connected service and related feature functionality requires a compatible vehicle network.

Some remote features require additional service activation. Log in to your Ford account for details. Some restrictions, third party terms and message or data rates may apply.

CONNECTED VEHICLE LIMITATIONS

Evolving technology, cellular networks, or regulations could affect functionality and availability, or continued provision of some features. These changes could even stop some features from functioning.

CONNECTING THE VEHICLE TO A MOBILE NETWORK

WHAT IS THE MODEM



The modem allows access to a range of features built into your vehicle.

ENABLING AND DISABLING THE MODEM

1. Press **Settings**.
2. Press **FordPass Connect**.
3. Press **Connectivity Settings**.
4. Switch connectivity features on or off.

CONNECTING FORDPASS TO THE MODEM

1. Make sure that the modem is enabled using the vehicle settings menu.
2. Open the FordPass app on your device and log in.
3. Add your vehicle or select your vehicle if already added.
4. Select the option to activate your vehicle.
5. Make sure that the name on the screen matches the name shown in your FordPass account.
6. Confirm that FordPass account is connected to the modem.

CONNECTING THE VEHICLE TO A WI-FI NETWORK - VEHICLES WITH: SYNC 3

1. Press **Settings**.
2. Press **Wi-Fi**.
3. Switch **Wi-Fi** on.
4. Press **View Available Networks**.
5. Select an available Wi-Fi network.

Note: Enter the network password to connect to a secure network.

Connected Vehicle

CONNECTED VEHICLE – TROUBLESHOOTING - VEHICLES WITH: MODEM

Symptom	Possible Cause and Resolution
I cannot confirm the connection of my FordPass account to the modem.	<ul style="list-style-type: none">- Modem is not enabled.<ul style="list-style-type: none">• Switch connectivity features on.- Weak network signal.<ul style="list-style-type: none">• Move your vehicle closer to a place where the network signal is not obstructed.

Connected Vehicle

CONNECTED VEHICLE – TROUBLESHOOTING - VEHICLES WITH: SYNC 3

Symptom	Possible Cause and Resolution
I cannot connect to a Wi-Fi network.	<ul style="list-style-type: none"> – Password error. <ul style="list-style-type: none"> • Enter the correct network password. – Weak network signal. <ul style="list-style-type: none"> • Move your vehicle closer to the Wi-Fi hotspot or to a place where the network signal is not obstructed. – Multiple access points in range with the same SSID. <ul style="list-style-type: none"> • Use a unique name for your SSID. Do not use the default name unless it contains a unique identifier, for example as part of the MAC address.
The Wi-Fi connection disconnects after successful connection.	<ul style="list-style-type: none"> – Weak network signal. <ul style="list-style-type: none"> • Move your vehicle closer to the Wi-Fi hotspot or to a place where the network signal is not obstructed.
I am close to a Wi-Fi hotspot but the network signal strength is weak.	<ul style="list-style-type: none"> – Obstructed network signal. <ul style="list-style-type: none"> • If your vehicle has a heated windshield, position your vehicle so that the windshield is not facing the Wi-Fi hotspot. • If your vehicle has metallic tinting on the windows but not on the windshield, position your vehicle so that the windshield is facing the Wi-Fi hotspot or open the windows that are facing the hotspot. • If your vehicle has metallic tinting on the windows and the windshield, open the windows that are facing the hotspot. • If your vehicle is in a garage and you have the garage door closed, open the garage door.
I cannot see a network in the list of available networks that I expect to see.	<ul style="list-style-type: none"> – Hidden network. <ul style="list-style-type: none"> • Make the network visible and try again.

Connected Vehicle

Symptom	Possible Cause and Resolution
I cannot see the Wi-Fi hotspot name when I search for Wi-Fi networks on my cell phone or other device.	<ul style="list-style-type: none">– System limitation.<ul style="list-style-type: none">• Make sure Wi-Fi hotspot visibility is on.• The system does not provide a Wi-Fi hotspot at this time.
Software downloads take too long.	<ul style="list-style-type: none">– Weak network signal.<ul style="list-style-type: none">• Move your vehicle closer to the Wi-Fi hotspot or to a place where the network signal is not obstructed.– Wi-Fi hotspot in high demand or has a slow Internet connection.<ul style="list-style-type: none">• Use a more reliable Wi-Fi hotspot.
The system seems to connect to a Wi-Fi network and the signal strength is excellent but the software does not update.	<ul style="list-style-type: none">– No software update available.– Wi-Fi network requires a subscription or acceptance of terms and conditions.<ul style="list-style-type: none">• Test the connection using another device. If the network requires a subscription or acceptance of terms and conditions, contact the network service provider.

Vehicle Wi-Fi Hotspot (If Equipped)

CREATING A VEHICLE WI-FI HOTSPOT

You can create a Wi-Fi hotspot in your vehicle and allow devices to connect to it for access to the Internet.



Select the settings option on the feature bar.

1. Press **FordPass Connect**.
2. Press **Vehicle Hotspot**.

Note: The vehicle hotspot default setting is on.

3. Press **Settings**.
4. Press **Wi-Fi visibility**.

Note: The Wi-Fi Visibility default setting is on.

Finding the Wi-Fi Hotspot Name and Password



Select the settings option on the feature bar.

1. Press **FordPass Connect**.
2. Press **Vehicle Hotspot**.
3. Press **Settings**.

Note: The SSID is the hotspot name.

4. Press **View Password**.

Connecting a Device to the Wi-Fi Hotspot

1. On your device, switch Wi-Fi on and select the hotspot from the list of available Wi-Fi networks.
2. When prompted, enter the password.

Purchasing a Data Plan

1. Connect a device to the hotspot.

Note: The vehicle network carrier's portal opens on your device.

2. If the portal does not open on your device, open a website and it redirects to the vehicle network carrier's portal.

Note: Secure websites do not redirect.

3. Follow the instructions on the carrier portal to purchase a plan.

Note: If you have an active plan, the system does not redirect to the vehicle network carrier's portal when you connect a device. Visit the vehicle network carrier's website to purchase more data.

Note: If data usage information is available in the vehicle hotspot menu, it is approximate.

Note: If you carry out a master reset, the system does not remove your vehicle from your vehicle network carrier's account. To remove your vehicle from the account, contact your vehicle network carrier.

Note: The vehicle network carrier provides Vehicle Hotspot services, subject to your vehicle network carrier agreement, coverage and availability.

CHANGING THE VEHICLE WI-FI HOTSPOT NAME OR PASSWORD



Select the settings option on the feature bar.

1. Press **FordPass Connect**.
2. Press **Vehicle Hotspot**.
3. Press **Settings**.
4. Press **Edit**.
5. Press **Change SSID Name**.
6. Enter your required SSID.
7. Press **Done**.
8. Press **Change Password**.
9. Enter your required password.
10. Press **Done**.

Audio System

GENERAL INFORMATION



WARNING: Driving while distracted can result in loss of vehicle control, crash and injury. We strongly recommend that you use extreme caution when using any device that may take your focus off the road. Your primary responsibility is the safe operation of your vehicle. We recommend against the use of any

hand-held device while driving and encourage the use of voice-operated systems when possible. Make sure you are aware of all applicable local laws that may affect the use of electronic devices while driving.

Radio Frequencies and Reception Factors

Note: *Listening to loud audio for long periods of time could damage your hearing.*

Radio Reception Factors	
Distance and strength	The further you travel from an AM or FM station, the weaker the signal and the weaker the reception.
Terrain	Hills, mountains, tall buildings, bridges, tunnels, freeway overpasses, parking garages, dense tree foliage and thunderstorms can interfere with the reception.
Station overload	When you pass a ground-based broadcast repeating tower, a stronger signal may overtake a weaker one and result in the audio system muting.

AUDIO UNIT



E286496

Note: *Depending on your vehicle option package, the controls may look different from what you see here.*

Note: *Some features, such as satellite radio, may not be available in your location. Check with an authorized dealer.*

Note: *The touchscreen system controls most of the audio features.*

Adjusting the Volume

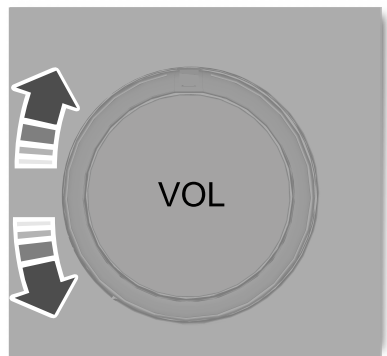

Turn to adjust the volume.

Audio System

Changing Radio Stations

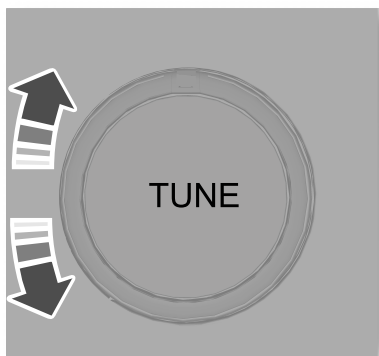

In radio mode, turn to search through the radio frequency band.

In satellite radio mode, turn to find the previous or next available satellite radio station.

Switching the Audio Unit On and Off



Press and release the button.

Using Seek, Fast Forward and Reverse



In radio mode, select a frequency band and press and release either button. The system stops at the first station it finds in that direction.

In satellite radio mode, press and release to select the next or previous satellite radio station. If you select a specific category, such as jazz, rock or news, press to find the next or previous station in that category.

DIGITAL RADIO (IF EQUIPPED)

Note: *HD Radio broadcasts are not available in all markets.*

HD Radio technology is the digital evolution of analog AM/FM radio. Your system has a special receiver that allows it to receive digital broadcasts, where available, in addition to the analog broadcasts, it already receives. Digital broadcasts provide a better sound quality than analog broadcasts with free, crystal-clear audio and no static or distortion. For more information, and a guide to available stations and programming, please visit www.hdradio.com.

When HD Radio is on and you tune to a station broadcasting HD Radio technology, you may notice the HD Radio logo on your screen. When this logo is available, you may also see Title and Artist fields on-screen.

The multicast indicator appears in FM mode, only, if the current station is broadcasting multiple digital broadcasts. The highlighted numbers signify available digital channels where new or different content is available. HD1 signifies the main programming status and is available in analog and digital broadcasts. Other multicast stations, HD2 through HD7, are only available digitally.

Audio System

When HD Radio broadcasts are active, you can access the following functions:

- **Memory presets** allow you to save an active channel as a memory preset. Touch and hold a memory preset slot until the sound returns. There is a brief mute while the radio saves the station. Sound returns when finished. When

switching to an HD2 or HD3 memory preset, the sound mutes before the digital audio plays, because the system has to reacquire the digital signal.

Note: *As with any saved radio station, you cannot access the saved station if your vehicle is outside the station's reception area.*

HD Radio Reception and Station Troubleshooting

Potential Reception Issues	
Reception area	If you are listening to a multicast station and you are on the fringe of the reception area, the station may mute due to weak signal strength.
	If you are listening to HD1, the system switches back to the analog broadcast until the digital broadcast is available again. However, if you are listening to any of the possible HD2-HD7 multicast channels, the station mutes and stays muted unless it is able to connect to the digital signal again.
Station blending	When the system first receives a station, aside from HD2-HD7 multicast stations, it first plays the station in the analog version. Once the receiver verifies the station is an HD Radio station, it shifts to the digital version. Depending on the station quality, you may hear a slight sound change when the station changes from analog to digital. Blending is the shift from analog to digital sound or digital back to analog sound.

In order to provide the best possible experience, use the contact form to report any station issues found while listening to a station broadcasting with HD Radio technology. Independent entities own and operate each station. These stations are responsible for the accuracy of all audio streams and data fields.

Audio System

Potential Station Issues		
Issues	Cause	Action
Echo, stutter, skip or repeat in audio. Increase or decrease in audio volume.	This is poor time alignment by the radio broadcaster.	No action required. This is a broadcast issue.
Sound fading or blending in and out.	The radio is shifting between analog and digital audio.	No action required. The reception issue may clear up as you continue to drive.
There is an audio mute delay when selecting HD2 or HD3, multicast preset or direct tune.	The digital multicast is not available until the HD Radio broadcast is decoded. Once decoded, the audio is available.	No action required. This is normal behavior. Wait until the audio is available.
Cannot access the HD2 or HD3 multicast channels when recalling a preset or from a direct tune.	The previously stored multicast preset or direct tune is not available in your current reception area.	No action required. The station is not available in your current location.
Text information does not match currently playing audio.	Data service issue by the radio broadcaster.	Fill out the station issue form at website listed below. ¹
There is no text information shown for currently selected frequency.	Data service issue by the radio broadcaster.	Fill out the station issue form at website listed below. ¹

¹ <http://hdradio.com/stations/feedback>.

HD Radio Technology manufactured under license from iBiquity Digital Corporation and foreign patents. HD Radio and the HD and HD Radio logos are proprietary trademarks of DTS. Ford and DTS are not responsible for the content sent using HD Radio technology. Content may be changed, added or deleted at any time at the station owner's discretion.

SATELLITE RADIO (IF EQUIPPED)

SiriusXM® Satellite Radio broadcasts a variety of music, news, sports, weather, traffic and entertainment satellite radio channels. For more information and a complete list of SiriusXM satellite radio channels, visit www.siriusxm.com in the United States, www.siriusxm.ca in Canada, or call SiriusXM at 1-888-539-7474.

Audio System

Note: This receiver includes the eCos real-time operating system. eCos is published under the eCos License.

Satellite Radio Reception Factors

Potential Satellite Radio Reception Issues	
Antenna obstructions	For optimal reception performance, keep the antenna clear of snow and ice build-up and keep luggage and other material as far away from the antenna as possible. Factory-installed and aftermarket vehicle structures including, but not limited to, roof racks and soft top roofs in a partially open position could reduce reception performance.
Terrain	Hills, mountains, tall buildings, bridges, tunnels, freeway overpasses, parking garages, dense tree foliage and thunderstorms can interfere with your reception.
Station overload	When you pass a ground-based broadcast-repeating tower, a stronger signal may overtake a weaker one and the audio system could mute.
Satellite radio signal interference	Your display may show ACQUIRING . . . to indicate the interference and the audio system could mute.

SiriusXM Satellite Radio Service

Note: SiriusXM reserves the unrestricted right to change, rearrange, add or delete programming including canceling, moving or adding particular channels, and its prices, at any time, with or without notice to you. Neither SiriusXM and its affiliates nor Ford Motor Company and its affiliates will be liable to you or any third party for any such modification, suspension or termination.



Audio System

SiriusXM satellite radio is a subscription-based satellite radio service that broadcasts a variety of music, sports, news, weather, traffic and entertainment programming. Your factory-installed SiriusXM satellite radio system includes hardware and a limited subscription term, which begins on the date of sale or lease of your vehicle. See an authorized dealer for availability.

For more information on extended subscription terms, a service fee is required, the online media player and a complete list of SiriusXM satellite radio channels, and other features, please visit www.siriusxm.com in the United States, www.siriusxm.ca in Canada, or call SiriusXM at 1-888-539-7474.

Satellite Radio Electronic Serial Number (ESN)

You need your ESN to activate, modify or track your satellite radio account.

Locating Your ESN

1. Select SiriusXM as the audio source.
2. Tune to channel 0.

Troubleshooting

Message	Condition	Action
Acquiring...	Radio requires more than two seconds to produce audio for the selected channel.	No action required. This message should disappear shortly.
Satellite antenna fault SIRIUS system failure	There is an internal module or system failure present.	If this message does not clear shortly, or with an ignition key cycle, your receiver may have a fault. See an authorized dealer for service.
Invalid Channel	The channel is no longer available.	Tune to another channel or choose another preset.
Unsubscribed Channel	Your subscription does not include this channel.	Contact SiriusXM at 1-888-539-7474 to subscribe to the channel, or tune to another channel.
No Signal	The signal is lost from the SiriusXM satellite or SiriusXM tower to your vehicle antenna.	The signal is blocked. When you move into an open area, the signal should return.

Audio System

Message	Condition	Action
Updating...	Update of channel programming in progress.	No action required. The process may take up to three minutes.
Questions? Call 1-888-539-7474	Your satellite service is no longer available.	Contact SiriusXM at 1-888-539-7474 to resolve subscription issues.
None found Check Channel Guide	All the channels in the selected category are either skipped or locked.	Use the channel guide to turn off the Lock or Skip function on that station.
Subscription Updated	SiriusXM has updated the channels available for your vehicle.	No action required.

USB PORT



WARNING: Driving while distracted can result in loss of vehicle control, crash and injury. We strongly recommend that you use extreme caution when using any device that may take your focus off the road. Your primary responsibility is the safe operation of your vehicle. We recommend against the use of any hand-held device while driving and encourage the use of voice-operated systems when possible. Make sure you are aware of all applicable local laws that may affect the use of electronic devices while driving.

USB A

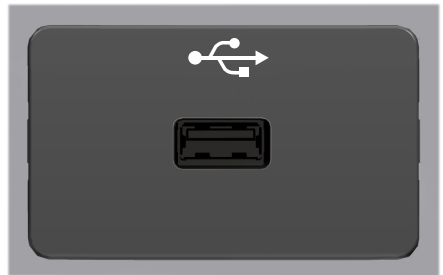

USB C



Audio System

The USB port allows you to plug in media playing devices, memory sticks and charge devices.

Note: *We recommend using only USB-IF certified cables and adapters. Non-certified cables and adapters may not work.*

Locating the USB Ports

The USB ports may be in the following locations:

- Inside the media bin.
- Inside the center console.
- On the lower instrument panel.

Note: *The number and type of USB ports may vary depending on your vehicle.*

Note: *Not all USB ports in your vehicle have data transfer capabilities. See **Auxiliary Power Points** (page 164).*

GENERAL INFORMATION



WARNING: Driving while distracted can result in loss of vehicle control, crash and injury. We strongly recommend that you use extreme caution when using any device that may take your focus off the road. Your primary responsibility is the safe operation of your vehicle. We recommend against the use of any hand-held device while driving and encourage the use of voice-operated systems when possible. Make sure you are aware of all applicable local laws that may affect the use of electronic devices while driving.

About SYNC

The system allows you to interact with the entertainment, information and communication systems on your vehicle using voice commands and a touchscreen. The system provides easy interaction with audio, phone, navigation, mobile apps and settings.

Note: You can switch the system on and use it for up to an hour without switching the ignition on.

Note: You can use the system after you switch the ignition off for up to 10 minutes or until you open a door.

Note: For your safety, some features are speed-dependent. Their use is limited to when your vehicle speed is less than 3 mph (5 km/h).

Using the Touchscreen

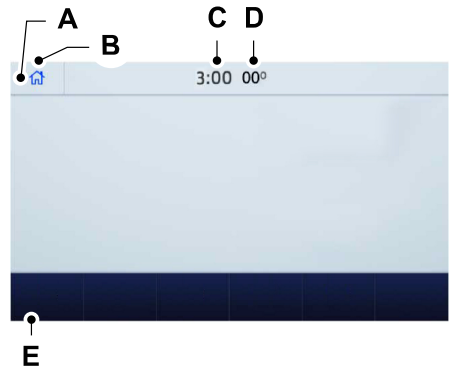

- A Status bar.
- B Home screen.
- C Clock. See **Settings** (page 458).
- D Outside air temperature.
- E Feature bar.

Status Bar

-  Cell phone microphone muted.
-  Audio system muted.
-  Software update installed.
-  Wi-Fi connected.
-  Cell phone roaming.
-  Text message received.



Automatic crash notification system off.



Cell phone network signal strength.



Vehicle data sharing on.



Vehicle location sharing on.



Vehicle data and vehicle location sharing on.



Wireless charger active.

Feature Bar



Select to use the radio, a USB, a media player or a **Bluetooth®** device. See **Entertainment** (page 435).



Select to adjust climate settings. See **Climate** (page 445).



Select to make calls and access the phonebook on your cell phone. See **Phone** (page 447).



Select to use the navigation system. See **Navigation** (page 449).



Select to search for and use compatible apps on your iOS or Android device. See **Apps** (page 455).



Select to adjust system settings. See **Settings** (page 458).

Cleaning the Touchscreen

See **Cleaning the Interior** (page 342).

Updating the System

Updating the System Using a USB Drive

Downloading an Update

1. Go to the SYNC update page on the local Ford website.
2. Download the update.

Note: *The website notifies you if an update is available.*

3. Insert a USB drive into your computer.

Note: *The USB drive needs to be empty and meet the minimum requirements detailed on the website.*

4. Follow the instructions provided to download the update to the USB drive.

Installing an Update

Note: *You can use the system when an installation is in progress.*

1. Disconnect all other USB devices from the USB ports.
2. Connect the USB drive with the update to a USB port.

Note: *Installation starts automatically within 10 minutes.*

Updating the System Using a Wi-Fi Network Connection

Connecting to a Wi-Fi Network



Select the settings option on the feature bar.

1. Select **Automatic Updates**.
2. Select **System Wi-Fi**.
3. Switch **System Wi-Fi** on.
4. Select **Available Wi-Fi Networks**.
5. Select an available Wi-Fi network.

Note: *Enter the network password to connect to a secure network.*

Switching Automatic System Updates On



Select the settings option on the feature bar.

1. Select **Automatic Updates**.
2. Switch **Automatic System Updates** on.

The system is now set to check for and receive system updates when it is connected to a Wi-Fi network.

Note: You can use the system when a download is in progress.

Note: If the system is disconnected from the Wi-Fi network when a download is in progress, the download continues the next time the system is connected to a Wi-Fi network.

Additional Information and Assistance

For additional information and assistance, we recommend that you contact an authorized dealer or refer to the local Ford website.

USING VOICE RECOGNITION

The system allows you to interact with the entertainment, information and communication systems on your vehicle using voice commands. This allows you to keep your hands on the steering wheel and focus on what is in front of you.



Press the voice control button on the steering wheel and wait for the voice prompt.

Note: Press the voice control button again to interrupt a voice prompt and begin speaking.

Note: Turn the volume control when a voice prompt plays to adjust the volume.

Note: Press and hold the voice control button on the steering wheel to use Siri on your iOS device.

The following voice commands are designed to help you from any screen:

- **List of Commands**
- **Help**

The following tables list some of the more frequently used voice commands. For a complete list of voice commands, refer to our website.

General

Voice Command	Description
___ List of Commands	Get a list of voice commands for a specific feature. ¹
Cancel	Cancel an active voice session.
___ Help	Get a list of voice commands for a specific feature. ¹
Go back	Return to the previous screen.
Main Menu	Go to the main menu.

SYNC™ 3

Voice Command	Description
Next Page	Go to the next page.
Previous Page	Go to the previous page.

¹ Add the name of the feature to the command.

Entertainment

Audio Source

Voice Command	Description
Radio	Use the radio.
CD Player	Use the CD player.
Bluetooth Stereo	Use a Bluetooth ® device.
USB	Use a USB or media player.

Radio

Voice Command	Description
AM	Listen to AM radio.
AM ____	Tune to a specific AM frequency. ¹
Sirius Channel ____	Listen to SiriusXM radio. ²
FM	Listen to FM radio.
FM ____	Tune to a specific FM frequency. ¹

¹ Add the radio frequency to two decimal places to the command.

² You can say the Sirius channel name or number such as "Sirius Channel 16" or "Sirius The Pulse".

SYNC™ 3

USB and Media Player

Voice Command	Description
Play Album ___	Play your music by category. ¹
Play Artist ___	
Play Genre ___	
Play Playlist ___	
Play Song ___	
Play Audiobook ___	
Play Podcast ___	
Browse All Albums	Browse music on a USB device.
Browse All Artists	
Browse All Audiobooks	
Browse All Genres	
Browse All Playlists	
Browse All Podcasts	
Browse All Songs	
Browse Album ___	Browse your music by category on a USB device. ¹
Browse Artist ___	
Browse Audiobook ___	
Browse Genre ___	
Browse Playlist ___	
Browse Podcast ___	

¹ Add an album name, artist name, audiobook name, genre name, playlist name, podcast name or track name to the command. Say the name exactly as it appears on your device.

Climate (If Equipped)

You can control the temperature of the vehicle using voice commands.

___ is a dynamic listing, meaning that for climate voice commands it can be the desired degrees for the temperature setting.

SYNC™ 3

To adjust the temperature, say:

Voice command	Description
Set Temperature ___	Adjust the temperature between 60–85°F (15.5–29.5°C).

Phone

Voice Command	Description
Pair Phone	Pair a cell phone or Bluetooth ®-enabled device.
Redial	Redial the last number that you dialed.
Dial ___	Dial a number. ¹
Call ___	Call a specific contact from your phonebook. ²
Call ___ ___	Call a specific contact from your phonebook at a specific location. ³
Listen to Message	Listen to a text message.
Listen to Message ___	Listen to a specific text message from a list of text messages.
Reply to Message	Reply to the last text message.

¹ Add the number you want to dial to the command.

² Add a contact name from your phonebook to the command. Say the first and last name of your contact exactly as it appears on your device.

³ Add a contact name and location from your phonebook to the command. Say the first and last name of your contact exactly as it appears on your device.

Navigation (If Equipped)

Setting a Destination

Voice Command	Description
Find an Address	Enter a destination address. When prompted, provide the house number, the street and city.
Find a Place	Search for a point of interest by name or by category.
Find the Next ____	Search for a nearby point of interest by category. ¹
Find a POI Category	Search for a point of interest category. ¹
Drive Home	Set your saved home address as your destination.
Drive to Work	Set your saved place of work as your destination.
Show Previous Destinations	Display and select from a list of previous destinations.
Show Favorites	Display and select from a list of favorite destinations.

¹ Add a point of interest category or the name of a major brand or chain to the command.

Route Guidance

Voice Command	Description
Cancel Route	Cancel the current route.
Detour	Select an alternate route.
Repeat Instruction	Repeat the last guidance prompt.
Show Route	Display an overview of the route.
Show Traffic	Display a list of traffic events on your route.
Show Map	Display the map on the touchscreen.
North Up	Display a two-dimensional map with north toward the top of the touchscreen.
Heading Up	Display a two-dimensional map with the direction you are traveling toward the top of the touchscreen.
Show 3D	Display a three-dimensional map with the direction you are traveling toward the front.

SYNC™ 3

Apps

General

Voice Command	Description
Mobile Applications	Start an app. The system prompts you for the app name.
List Applications	Get a list of apps running on your device.
Find Applications	Search and connect to apps running on your device.

Active App

Voice Command	Description
___ Help	Get a list of voice commands for a specific app. ¹
Exit ___	Close an app. ¹

¹Add an app name to the command.

SiriusXM Traffic and Travel Link (If Equipped)

Voice command	Description
Show Traffic	Displays a list of traffic incidents.
Show Weather Map	Displays the current weather map.
Show Fuel Prices	Displays a list of fuel prices.
Show 5 Day Forecast	Displays the 5 day weather forecast.

Voice Settings

Voice Command	Description
Voice Settings	Go to the voice settings menu.
Interaction Mode Novice	Switch long voice prompts on.
Interaction Mode Advanced	Switch short voice prompts on.
Phone Confirmation On	Switch call confirmation on. The system prompts you to confirm before making a call.
Phone Confirmation Off	Switch call confirmation off. The system does not prompt you to confirm before making a call.
Voice Command Lists On	Switch the display of voice commands on.
Voice Command Lists Off	Switch the display of voice commands off.

Automatic Blower Motor Speed Reduction

If necessary, the system decreases the blower motor speed when you are using voice commands to reduce the amount of background noise in your vehicle. It returns to normal when you are done.

Switching Automatic Blower Motor Speed Reduction Off

Simultaneously press the **A/C** and recirculated air buttons.

ENTERTAINMENT

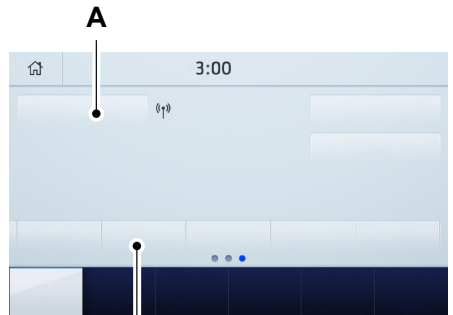

- A Audio source. Select to choose a different audio source.
- B Presets. Swipe left to view more presets.

You can access these options using the touchscreen or voice commands.

SYNC™ 3

Sources

Press this button to select the source of media you want to listen to.

Menu Item	
AM	
FM	
SIRIUS ¹	
CD	
USB	The name of the USB that is plugged in displays here.
Bluetooth Stereo	
Apps	If you have SYNC 3 compatible apps on your connected smart phone, they display here as individual source selections.

¹ This feature may not be available in all markets and requires an active subscription.

AM/FM Radio

Tuning a Station

You can use the tune or seek controls on the radio bezel to select a station.

To tune a station using the touchscreen, select:

Menu Item
Direct Tune

A pop up appears, allowing you to type in the frequency of a station. You can only enter a valid station for the source you are currently listening to.

You can press the backspace button to delete the previously entered number.

Once you have entered the station's call numbers, you can select:

Menu Item	Action and Description
Enter	Press to begin playing the station you have entered.
Cancel	Press to exit without changing the station.

Presets

To set a new preset, tune to the station and then press and hold one of the memory preset buttons. The audio mutes briefly while the system saves the station and then returns.

You may be able to add additional preset pages using the settings option on the feature bar.

SiriusXM® Satellite Radio (If Activated)

Note: *This feature may not be available in all markets and requires an active subscription.*



SiriusXM satellite radio is a subscription-based satellite radio service that broadcasts a variety of music, sports, news, weather, traffic and entertainment programming. Your factory-installed SiriusXM satellite radio system includes hardware and a limited subscription term that begins on the date of sale or lease of your vehicle. See an authorized dealer for availability.

For more information on extended subscription terms (a service fee is required), the online media player and a list of SiriusXM satellite radio channels, and other features, please visit www.siriusxm.com in the United States, www.siriusxm.ca in Canada, or call SiriusXM at 1-888-539-7474.

Note: *SiriusXM reserves the unrestricted right to change, rearrange, add or delete programming including canceling, moving or adding particular channels, and its prices, at any time, with or without notice to you. Neither SiriusXM and its affiliates nor Ford Motor Company and its affiliates will be liable to you or any third party for any such modification, suspension or termination.*

Note: *This receiver includes the eCos real-time operating system. eCos is published under the eCos License.*

The following buttons are available for SiriusXM:

Menu Item	Action and Description	
Browse	Touch this button to see a list of available stations.	
Direct Tune	A pop-up appears, allowing you to type in the call numbers of a station. Once you enter the stations call numbers, you can select:	
	Enter	The system tunes to the station you select.
	Cancel	You exit the pop-up and the current station continues to play.
	You can press the backspace button to delete the previous number.	

SYNC™ 3

Menu Item	Action and Description	
Replay	Replay audio on the current channel. You can replay approximately 45 minutes of audio as long as you remain tuned to the current station. Changing stations erases the previous audio.	
	Live	When you are in replay mode, you are not able to select a different preset until you return to live audio. Pressing this button returns you to the live broadcast.
ALERT	Save the current song, artist, or team as a favorite. The system alerts you when it plays again on any channel. Selecting this button allows you to enable and edit alerts.	

Memory Presets

To set a preset, tune to the station then press and hold one of the memory preset buttons. The audio mutes briefly while the system saves the station and returns once the station is stored.

You may be able to add additional preset pages using the settings option on the feature bar.

SiriusXM Satellite Radio Reception Factors and Troubleshooting

Potential Reception Issues	
Antenna obstructions	For optimal reception performance, keep the antenna clear of snow and ice build-up and keep luggage and other materials as far away from the antenna as possible.
Terrain	Hills, mountains, tall buildings, bridges, tunnels, freeway overpasses, parking garages, dense tree foliage and thunderstorms can interfere with your reception.
Station overload	When you pass a ground-based broadcast-repeating tower, a stronger signal may overtake a weaker one and the audio system may mute.
Satellite radio signal interference	Your display may show ACQUIRING... to indicate the interference and the audio system may mute.

SYNC™ 3

Troubleshooting Tips		
Message	Cause	Action
Acquiring Signal	Radio requires more than two seconds to produce audio for the selected channel.	No action required. This message should disappear shortly.
Satellite antenna fault SIRIUS system failure	There is an internal module or system failure present.	If this message does not clear shortly, or with an ignition key cycle, your receiver may have a fault. See an authorized dealer for service.
Invalid Channel	The channel is no longer available.	Tune to another channel or choose another preset.
Unsubscribed Channel	Your subscription does not include this channel.	Contact SiriusXM at 1-888-539-7474 to subscribe to the channel, or tune to another channel.
Satellite acquiring signal...	The signal is lost from the SiriusXM satellite or SiriusXM tower to your vehicle antenna.	The signal is blocked. When you move into an open area, the signal should return.
Updating...	Update of channel programming in progress.	No action required. The process may take up to three minutes.
Questions? Call 1-888-539-7474	Your satellite service is no longer available.	Contact SiriusXM at 1-888-539-7474 to resolve subscription issues.
None found. Check channel guide.	All the channels in the selected category are either skipped or locked.	Use the channel guide or the Sirius XM Settings tile to turn off the Lock or Skip function on that station.
SIRIUS Subscription updated	SiriusXM has updated the channels available for your vehicle.	No action required.

HD Radio™ Information (If Available)

To activate HD radio, please see the Radio Settings in the Settings Chapter. See **Settings** (page 458).

Note: HD Radio broadcasts are not available in all markets.

SYNC™ 3

HD Radio technology is the digital evolution of analog AM/FM radio. Your system has a special receiver that allows it to receive digital broadcasts (where available) in addition to the analog broadcasts, it already receives. Digital broadcasts provide a better sound quality than analog broadcasts with free, crystal-clear audio and no static or distortion. For more information, and a guide to available stations and programming, please visit:

Website
www.hdradio.com

When HD Radio is on and you tune to a station broadcasting HD Radio technology, you may notice the following indicators on your screen:



The HD logo is grey when acquiring a digital station, and then changes to orange when digital audio is playing. When this logo is available, you may also see Title and Artist fields on-screen.

The multicast indicator appears in FM mode (only) if the current station is broadcasting multiple digital broadcasts. The highlighted numbers signify available digital channels where new or different content is available. HD1 signifies the main programming status and is available in analog and digital broadcasts. Other multicast stations (HD2 through HD7) are only available digitally.

Note: *There is also an additional feature for stations that have more than 1 HD multicast (For example, HD1 or HD2). The HD logo and Radio text appears as a button. Pressing this button allows you to cycle through all of the HD stations on that specific frequency. For example, if you are on 101.1 and it has HD1, HD2, HD3, pressing the button repeatedly causes the radio to cycle through the HD stations in a cyclic increasing order.*

When HD Radio broadcasts are active, you can access the following functions:

Message	Action and Description
Presets	Allows you to save an active channel as a memory preset. Touch and hold a memory preset slot until the sound returns. There is a brief mute while the radio saves the station. Sound returns when the channel saves. When switching to an HD2 or HD3 memory preset, the sound mutes before the digital audio plays, because the system has to reacquire the digital signal.

Note: *As with any station you save, you cannot access the saved station if your vehicle is outside the station's reception area.*

SYNC™ 3

HD Radio Reception and Station Troubleshooting

Potential Reception Issues	
Reception area	If you are listening to a multicast station and you are on the fringe of the reception area, the station may mute due to weak signal strength.
	If you are listening to HD1, the system changes back to the analog broadcast until the digital broadcast is available again. However, if you are listening to any of the possible HD2-HD7 multicast channels, the station mutes and stays muted unless it is able to connect to the digital signal again.
Station blending	When the system first receives a station (aside from HD2-HD7 multicast stations), it first plays the station in the analog version. Once the receiver verifies the station is an HD Radio station, it shifts to the digital version. Depending on the station quality, you may hear a slight sound change when the station changes from analog to digital. Blending is the shift from analog to digital sound or digital back to analog sound.

In order to provide the best possible experience, use the contact form to report any station issues found while listening to a station broadcasting with HD Radio technology. Independent entities own and operate each station. These stations are responsible for ensuring all audio streams and data fields are accurate.

Potential Station Issues		
Issues	Cause	Action
Echo, stutter, skip or repeat in audio. Increase or decrease in audio volume.	This is poor time alignment by the radio broadcaster.	No action required. This is a broadcast issue.
Sound fading or blending in and out.	The radio is shifting between analog and digital audio.	No action required. The reception issue may clear up as you continue to drive.
There is an audio mute delay when selecting HD2 or HD3, multicast preset or Direct Tune.	The digital multicast is not available until the HD Radio broadcast is decoded. Once decoded, the audio is available.	No action required. This is normal behavior. Wait until the audio is available.

SYNC™ 3

Potential Station Issues		
Issues	Cause	Action
Cannot access HD2 or HD3 multicast channel when recalling a preset or from a direct tune.	The previously stored multicast preset or direct tune is not available in your current reception area.	No action required. The station is not available in your current location.
Text information does not match currently playing audio.	Data service issue by the radio broadcaster.	Fill out the station issue form. ¹
There is no text information shown for currently selected frequency.	Data service issue by the radio broadcaster.	Fill out the station issue form. ¹

¹ You can find the form here:

Website
http://hdradio.com/stations/feedback

HD Radio Technology manufactured under license from iBiquity Digital Corporation and foreign patents. HD Radio and the HD and HD Radio logos are proprietary trademarks of DTS. The vehicle manufacturer and DTS are not responsible for the content sent using HD Radio technology. Content may be changed, added or deleted at any time at the station owner's discretion.

CD (If Equipped)

Once you select this option, the system returns you to the main audio screen.

The current audio information appears on the screen.

The following buttons are also available:

Button	Function
Browse	You can use the browse button to select a track.
Repeat	Select this button and a small number one displays to indicate the track is set to repeat.

SYNC™ 3

Button	Function
	For MP3 CDs, this button allows you to toggle through repeat off, repeat one track (a small number one displays), and repeat current folder (a small folder displays).
Shuffle	Select the shuffle symbol to have the audio on the disk play in random order.

You can use the forward, reverse, pause or play buttons to control the audio playback.

Bluetooth® Stereo or USB

Bluetooth® Stereo and USB allow you to access media that you store on your **Bluetooth®** device or USB device such as music, audio books or podcasts.

The following buttons are available for Bluetooth® and USB:

Button	Function
Repeat	Pressing the repeat button toggles the repeat setting through three modes: repeat off (button not highlighted), repeat all (button highlighted) and repeat track (button highlighted with a small number one).
Shuffle	Play the tracks in random order.

You can use the forward, reverse, pause or play buttons to control the audio playback.

To get more information about the currently playing track, press the cover art or Info button.

For some devices, SYNC 3 is able to provide 30-second skip buttons when you listen to audio books or podcasts. These buttons allow you to skip forward or backward within a track.

While playing audio from a USB device you can look for certain music by selecting the following:

Button	Function
Browse	If available, displays the list of tracks in the Now Playing playlist.
New Search	This option, which is available under browse, allows you to play all tracks or to filter the available media into one of the below categories.
	Play All

SYNC™ 3

Button	Function
	Playlists
	Artist
	Albums
	Songs
	Genres
	Podcasts
	Audio books
	Composers
A-Z Jump	This button allows you to choose a specific letter to view within the category you are browsing.
Explore Device	If available, this allows you to browse the folders and files on your USB device.

USB Ports



E211463

The USB ports are in the center console or behind a small access door in the instrument panel.

This feature allows you to plug in USB media devices, memory sticks, flash drives or thumb drives, and charge devices if they support this feature.

Select this option to play audio from your USB device.

Apps

The system supports the use of certain audio apps such as iHeartRadio through a USB or **Bluetooth**®-enabled device.

Each app gives you different on-screen options depending on the app's content. See **Apps** (page 455).

Supported Media Players, Formats and Metadata Information

The system is capable of hosting nearly any digital media player, including iPod, iPhone, and most USB drives.

Supported audio formats include MP3, WMA, WAV, AAC, and FLAC.

Supported audio file extensions include MP3, WMA, WAV, M4A, M4B, AAC, and FLAC.

SYNC™ 3

Supported USB file systems include: FAT, exFAT, and NTFS.

SYNC 3 is also able to organize the media from your USB device by metadata tags. Metadata tags, which are descriptive software identifiers embedded in the media files, provide information about the file.

If your indexed media files contain no information embedded in these metadata tags, SYNC 3 may classify the empty metadata tags as unknown.

SYNC 3 is capable of indexing up to 50,000 songs per USB device, for up to 10 devices.

CLIMATE

Touch the climate button on the touchscreen to access the climate control features.

Note: You can switch temperature units between Fahrenheit and Celsius. See **Settings** (page 458).

Accessing the Climate Control Menu



Touch the button to access additional controls for the front climate system.

Directing the Airflow



Touch the button to direct airflow to the windshield air vents and de-mister.



Touch the button to direct airflow to the instrument panel air vents.



Touch the button to direct airflow to the footwell air vents.

You can direct air through any combination of these air vents.

Setting the Blower Motor Speed



Touch up or down to increase or decrease the volume of air that circulates in your vehicle.

Setting the Temperature

Touch up or down on the left-hand temperature control to set the left-hand temperature.

Note: This control also adjusts the right-hand side temperature when you switch off dual zone mode.

Touch up or down on the right-hand temperature control to set the right-hand temperature.

Switching Auto Mode On and Off



Touch the button to switch on automatic operation, then set the temperature.

The system adjusts the blower motor speed, air distribution, air conditioning operation, and outside or recirculated air to reach and maintain the temperature you have set.

Switching the Air Conditioning On and Off



A pop-up appears on the screen to display the air conditioning options.

MAX A/C: Touch the button to activate and maximize cooling. The driver and passenger temperatures are set to LO, recirculated air flows through the instrument panel vents, air conditioning automatically turns on and the fan automatically adjusts to the highest speed.

A/C: Touch to switch the air conditioning on or off. Use A/C with recirculated air to improve cooling performance and efficiency.

Note: *In certain conditions, such as maximum defrost, the air conditioning compressor may continue to operate even though you switch off the air conditioning.*

Switching the Climate Control On and Off



Touch the button.

Switching the Climate Controlled Seats On and Off



Touch the button to cycle through the various climate controlled seat settings.

Switching Dual Zone Mode On and Off



Touch the button to switch on temperature control for the right-hand side of the vehicle.

Switching the Heated Exterior Mirrors On and Off



Touch the button.

Switching the Heated Windshield On and Off



Touch the button to clear the windshield of thin ice and fog. The heated windshield turns off after a short period of time.

Switching the Heated Rear Window On and Off



Touch the button to clear the rear window of thin ice and fog.

Switching the Heated Seats On and Off



Touch the button to cycle through the various heat settings.

Switching the Heated Steering Wheel On and Off



Touch the button.

Switching Maximum Air Conditioning On and Off



Touch the button for maximum cooling.

Recirculated air flows through the instrument panel air vents, air conditioning turns on and the blower motor adjusts to the highest speed.

Switching Maximum Defrost On and Off



Touch the button for maximum defrosting.

Air flows through the windshield air vents, and the blower motor adjusts to the highest speed.

You can also use this setting to defog and clear the windshield of a thin covering of ice.

Note: *To prevent window fogging, you cannot select recirculated air when maximum defrost is on.*

Note: The heated rear window also turns on when you select maximum defrost.

Note: Depending on your region, air conditioning turns on.

Switching Recirculated Air On and Off



Touch the button to switch between outside air and recirculated air.

The air currently in the passenger compartment recirculates. This may reduce the time needed to cool the interior, when used with **A/C**, and reduce unwanted odors from entering your vehicle.

Note: Recirculated air may turn off, or prevent you from switching on, in all air flow modes except **MAX A/C** to reduce the risk of fogging. Recirculation may also turn on and off in various air distribution control combinations during hot weather to improve cooling efficiency.

Switching the Ventilated Seats On and Off



Touch the button to cycle through the various ventilated seat settings.

Accessing Rear Climate Controls



Touch the button to access additional controls for the rear climate system.

Rear Climate Control Lock Indicator



Touch the button.

When on, you can only operate the rear passenger settings through the front controls.

Switching Rear Auto Mode On and Off



Touch the button to switch on rear automatic operation, then set the temperature.

PHONE



WARNING: Driving while distracted can result in loss of vehicle control, crash and injury. We strongly recommend that you use extreme caution when using any device that may take your focus off the road. Your primary responsibility is the safe operation of your vehicle. We recommend against the use of any hand-held device while driving and encourage the use of voice-operated systems when possible. Make sure you are aware of all applicable local laws that may affect the use of electronic devices while driving.

Check the compatibility of your device on the regional website.

Pairing Your Cell Phone for the First Time

Go to the settings menu on your device and switch **Bluetooth®** on.



Select the phone option on the feature bar.

1. Select **Add Phone**.

Note: A prompt alerts you to search for your vehicle on your cell phone.

2. Select your vehicle on your cell phone.

Note: A number appears on your cell phone and on the touchscreen.

3. Confirm that the number on your cell phone matches the number on the touchscreen.

SYNC™ 3

Note: The touchscreen indicates that you have successfully paired your cell phone.

4. Download the phonebook from your cell phone when you are prompted.

Note: If you pair more than one cell phone, use the phone settings to specify the primary phone. You can change this setting at any time.

Using Your Cell Phone (If Equipped)

Recent Call List

Display and select an entry from a list of previous calls.

Contacts

Display a smart search form to look up your contacts. Use the List button to alphabetically sort your contacts.

Change Phone

Display the list of paired or connected devices that you can select.

Phone Settings

Change ring tones, alerts or pair another phone.

Do Not Disturb

Reject incoming calls and switch ring tones and alerts off.

Using Text Messaging

Menu Item	Description
Hear It	Hear the text message.
View	View the text message.
Call	Call the sender.
Reply	Reply to the text message with a standard text message.

Phone Keypad

Directly dial a number.

Mute

Mute the microphone when in a call.

Phone Voice Assistant

Say a command to use the Google or Siri voice assistant available on your connected phone to access supported features.

Text Messaging

Setting Text Message Notification

iOS

1. Go to the settings menu on your cell phone.
2. Select **Bluetooth®**.
3. Select the information icon to the right of your vehicle.
4. Switch text message notification on.

Android

1. Go to the settings menu on your cell phone.
2. Select **Bluetooth®**.
3. Select the profiles option.
4. Select the phone profile.
5. Switch text message notification on.

Apple CarPlay (If Equipped)

1. Connect your device to a USB port.
2. Follow the instructions on the touchscreen.

Note: Certain features of the system are not available when you are using Apple CarPlay.

Switching Apple CarPlay Off



Select the settings option on the feature bar.

1. Select **Apple CarPlay Preferences**.
2. Switch **Apple CarPlay** off.

Android Auto (If Equipped)

1. Connect your device to a USB port.
2. Follow the instructions on the touchscreen.

Note: You might need to enable Android Auto from the settings menu.

Note: Certain features of the system are not available when you are using Android Auto.

Switching Android Auto Off



Select the settings option on the feature bar.

1. Select **Android Auto**.

2. Switch **Android Auto** off.

NAVIGATION (IF EQUIPPED)

Note: For more information, refer to our website.



Select the navigation option on the feature bar.

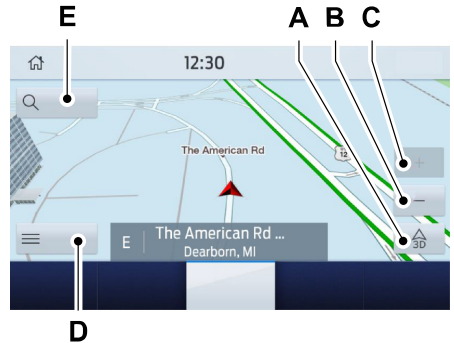

- A Map view menu.
- B Zoom out.
- C Zoom in.
- D Route guidance menu.
- E Destination entry menu.

Setting a Destination

Destination Entry Menu

Item	Description
Search	Enter a destination address.
Previous Destinations	Display and select from a list of previous destinations.
Home	Set your saved home address as your destination
Work	Set your saved place of work as your destination.
Favorites	Display and select from a list of favorite destinations.

Setting a Destination Using the Text Entry Screen

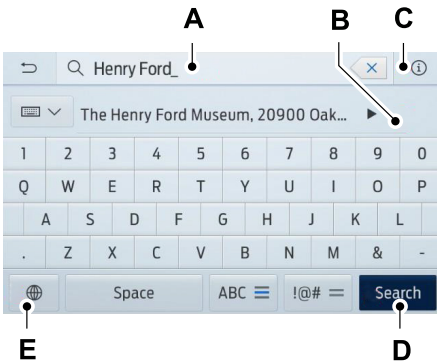

You can search by entering all or part of the destination, such as the Address, POI Category or Name, Intersection, City, Latitude/Longitude, etc. Tips: If you do not specify a location, the system will use the current vehicle location. You can specify a location by address, city, state or zip code. For additional search support, please visit: support.ford.com.

Note: Press the button in the top right-hand corner of the main map to display estimated time of arrival, the remaining travel time or distance to destination.

- A Text entry field.
- B Automatic suggestions based on the text you enter.
- C Information icon.
- D Search.
- E Keyboard settings.

Note: Select one of the suggestions to copy the detail to the text entry field.

Setting a Destination Using the Map Screen

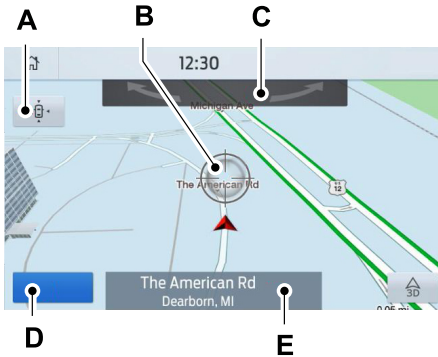

- A Re-center the map.
- B Selected location.
- C 3D map rotation. Swipe left or right.
- D Start route guidance.
- E Destination name.

Select the location on the map.
 Select **Start** to begin route guidance.

Changing the Format of the Map

Display the map in one of the following formats:

- A two-dimensional map with the direction you are traveling toward the top of the screen.
- A two-dimensional map with north toward the top of the screen.
- A three-dimensional map with the direction you are traveling toward the front.

Zoom

Display more or less detail on the map.

Note: Use pinch gestures to zoom in and out. Place two fingers on the screen and move them apart to zoom in. Place two fingers on the screen and bring them together to zoom out.

Route Guidance

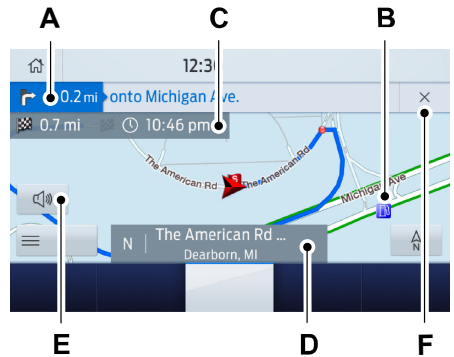

- A Turn indicator. Select to hear the last voice prompt.
- B Point of interest.
- C Estimated time of arrival, distance to destination or time to destination.
- D Current road.
- E Mute guidance prompts.
- F Cancel route guidance.

Note: To change guidance prompt volume, turn the volume control when a guidance prompt plays.

Route Guidance Menu

Menu Item	Description
Screen View	Adjust your map preferences for when route guidance is active.
Full Map	View a full-screen map when route guidance is active.
Highway Exit Info	View highway exit information for your current route.
Turn List	View the turn list for your current route. Select a road to avoid it.
Traffic List	You can find the SiriusXM Traffic and Travel Link information by pressing this button. This information requires an active subscription to SiriusXM Traffic and Travel Link. When a route is not active, a list of nearby traffic incidents displays. When a route is active, you can choose to display a list of traffic nearby or on the route.
Navigation Settings	Adjust navigation settings. See Settings (page 458).
Where Am I?	View information about your current location.
Cancel Route	Cancel route guidance.
View Route	View the entire current route on the map.
Detour	View an alternative route compared to your current one.
Edit Waypoints	Change the order or remove waypoints.
Optimize Order	The system determines the order of waypoints for you.
Go	Go to the next screen and start the new route.

Adjusting the Guidance Prompt Volume

Turn the volume control when a guidance prompt plays to adjust the volume.

Note: *If you have inadvertently adjusted the volume to zero, press the turn indicator button to play the last voice prompt and then adjust the volume to the desired level.*

Muting Guidance Prompts



Select the mute option on the screen to mute guidance prompts.

Note: *The system mutes the next and all future guidance prompts.*

Adding Waypoints

You can add a waypoint to a navigation route as a destination along your route. You can add up to five waypoints.

1. Select the search option on the map.
2. Set a destination.
3. Select **Add Waypoint**.
4. Select **Go**.

Canceling Route Guidance



Select the route guidance menu option on the active guidance screen.

Select **Cancel Route**.

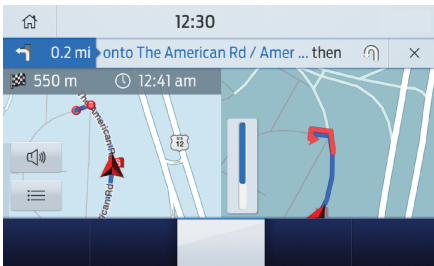

Note: *The route guidance menu option is always in the bottom right-hand corner of the main map.*

cityseeker (If Equipped)



cityseeker

E225487

cityseeker, when available, is a service that provides more information about certain points of interest such as restaurants, hotels and attractions.

Note: *cityseeker information is limited to approximately 1,110 cities (1,049 in the United States, 36 in Canada and 15 in Mexico).*

When you have selected a point of interest, the location and information appear, such as address, phone number and a star rating.

Press **More Information** to see a photo, a review, a list of services and facilities, the average room or meal price and the web address. This screen displays the point of interest icons.

For restaurants, cityseeker can provide information such as star rating, average cost, review, handicap access, hours of operation, and website address.

For hotels, cityseeker can provide information such as star rating, price category, review, check-in and checkout times, hotel service icons and website address. Hotel service icons include:

- Restaurant
- Business center
- Handicap facilities
- Laundry
- Refrigerator
- 24-hour room service
- Fitness center
- Internet access
- Pool
- Wi-Fi

Attractions include nearby landmarks, amusement parks, historic buildings and more. cityseeker can provide information such as star rating, reviews, hour of operation and admission price.

SiriusXM Traffic and Travel Link (If Equipped)

SiriusXM Traffic and Travel Link is available on vehicles equipped with navigation and only in select markets. You must activate and subscribe to receive SiriusXM Traffic and Travel Link information. It helps you locate the best gas prices, find movie listings, get current traffic alerts, view the weather map, get accurate ski conditions and see current sports scores.

The system calculates a reasonable efficient route based on available speed limits, traffic, and road conditions. You may know a local shortcut that is more efficient at a given time than the route provided by SYNC 3, but you should expect a slight difference in minutes or miles with the SYNC 3 route.

Michelin Travel Guide (If Equipped)

The Michelin travel guide is a service that provides additional information about certain places of interest, for example restaurants, hotels and tourist sites. Points of interest that have Michelin travel guide information display a button to show you more information. Push the button to see the additional information. If you have paired your phone with the system, you can press the phone button to directly establish a call with the selected point of interest.

Navigation Map Accuracy and Updates

HERE is the digital map provider for the navigation application. If you find map data errors, you may report them directly to HERE by going to www.here.com. HERE evaluates all reported map errors and responds with the result of their investigation by e-mail.

The navigation system map data may contain inaccurate or incomplete information due to the passage of time, changing circumstances, sources used and the nature of collecting comprehensive geographic data, any of which may lead to incorrect results. Inaccurate speed limit information, turn restrictions and other road attributes may affect the determined route and associated guidance

Annual navigation map updates are available for purchase through your dealership. Depending on your purchase agreement, you might be eligible for a free map update. You can choose to download the map data update onto a USB, order a USB, or use Wi-Fi to deliver automatic updates. To update your map data over Wi-Fi, your vehicle must be connected to a Wi-Fi access point. Map data files are large, so it is highly recommended to perform the update when free Wi-Fi is available otherwise high data rates may apply. For USB updates, free map update eligibility, and other details, contact dealers at 1-866-462-8837 in the United States and Canada or 800-557-5539 in Mexico or visit our local website for more information.

ELECTRIC VEHICLE INFORMATION

Power Flow



The power flow information for your hybrid vehicle is available through the home screen or under Apps.

Vehicle Operational States

Power flows to or from the front and rear wheels depending on the operational state and the drive conditions.

- **Idling:** The vehicle is running and in park (P). The engine and/or the high voltage battery are on.
- **Electric Driving:** The vehicle is running and in drive (D) or neutral (N). The high voltage battery provides power to the wheels.
- **Hybrid Driving:** The vehicle is running and in drive (D) or neutral (N). The engine and the high voltage battery provide power to the wheels.
- **Regenerative Braking:** The vehicle is running in drive (D) and is slowing down. Power captured by the regenerative braking system is sent back to the high voltage battery.
- **Battery Charging:** The engine is on to charge the high voltage battery. The vehicle returns to electric operation once the battery is charged.
- **Low Gear:** The engine is on because the vehicle is in low gear. Shift out of low gear to return to electric operation.
- **Normal Operation:** The engine is on to optimize vehicle operation. The vehicle returns to electric operation when possible.
- **Engine Braking Active:** The engine is on to provide increased powertrain braking. This can occur when you turn on grade assist, when speed control is on or when driving with your foot off the accelerator pedal. Turning off grade assist or speed control may allow the vehicle to return to electric operation.

Engine On Due To

The following conditions help to explain why the engine is on, and what you can do to allow all electric operation.

- **Drive Power:** The engine is on due to accelerator pedal pressure or speed control activation. Reduce pressure on the accelerator pedal or switch off the speed control to return to full electric mode.
- **High Speed:** The engine is on because the vehicle speed exceeds the level for full electric operation. Reduce the speed to return to electric operation.
- **Heater Setting:** The engine is on because of the heater setting. Reduce or turn off the heater setting to return to electric operation.
- **Neutral Gear:** The engine is on because the vehicle is in neutral (N). Shift out of neutral gear to return to electric operation.
- **Engine Cold:** The engine is on because it is cold. The vehicle returns to electric operation once the engine is sufficiently warm.
- **Battery Temperature:** The engine is on due to a high or low high voltage battery temperature. This is a normal operating condition. The vehicle returns to electric operation when possible.
- **Drive Mode:** The engine is on due to the drive mode selection. Select an appropriate drive mode for electric only operation.

APPS

The system allows you interact with select mobile apps while keeping your eyes on the road. Voice commands, your steering wheel buttons, or a quick tap on your touchscreen give you advanced control of compatible mobile apps. You can also stream your favorite music or podcasts, share your time of arrival with friends, and keep connected safely.

When you start an app through the system for the first time, you could be asked to grant certain permissions. You can review and change the permissions that you have granted at any time when your vehicle is not moving. We recommend that you check your data plan before using your apps through the system. Using them could result in additional charges. We also recommend that you check the app provider's terms and conditions and privacy policy before using their app. Make sure that you have an active account for apps that you want to use through the system. Some apps will work with no setup. Others require you to configure some personal settings before you can use them.

Note: For more information about available apps, visit catalog.ford.com.

Using Apps on an iOS Device



Select the apps option on the feature bar.

1. If your device is connected via USB, switch Apple CarPlay off. See **Phone** (page 447).
2. Connect your device to a USB port or pair and connect using Bluetooth.
3. If prompted to enable CarPlay, select **Disable**.
4. Start the apps on your device that you want to use through SYNC.

Note: If you close the apps on your device, you will not be able to use them through the system.

5. Select the app that you want to use on the touchscreen.

Note: Connect your device to a USB port if you want to use a navigation app. When using a navigation app, keep your device unlocked and the app open.

Using Apps on an Android Device



Select the apps option on the feature bar.

1. If your device is connected via USB, switch Android Auto off. See **Phone** (page 447).
2. Pair your device. See **Phone** (page 447).
3. Start the apps on your device that you want to use through SYNC.

Note: If you close the apps on your device, you will not be able to use them through the system.

4. Select **Find Mobile Apps**.

Note: The system searches and connects to compatible apps that are running on your device.

5. Select the app that you want to use on the touchscreen.

Note: Mobile Apps on your device use the USB port to establish a connection with SYNC. Some devices may lose the ability to play music over USB when Mobile Apps are enabled.

Using Mobile Navigation on an Android Device

1. Connect your device to a USB port.
2. Switch Android Auto off. See **Phone** (page 447).
3. Switch on **Enable Mobile Apps via USB** in the Mobile Apps Settings tile.
4. Select the apps option on the feature bar.
5. Select the navigation app that you want to use on the touchscreen.

Note: When using a navigation app, keep your device unlocked and the app open.

SiriusXM Traffic and Travel Link (if Equipped)



WARNING: Driving while distracted can result in loss of vehicle control, crash and injury. We strongly recommend that you use extreme caution when using any device that may take your focus off the road. Your primary responsibility is the safe operation of your vehicle. We recommend against the use of any hand-held device while driving and encourage the use of voice-operated systems when possible. Make sure you are aware of all applicable local laws that may affect the use of electronic devices while driving.

Note: SiriusXM Traffic and Travel Link may not be available in all markets.

Note: In order to use SiriusXM Traffic and Travel Link, your vehicle must have navigation.

Note: A paid subscription is required to access and use these features. Go to www.siriusxm.com/travellink for more information.

Note: Visit www.siriusxm.com/traffic and click on Coverage map and details for a complete listing of all traffic areas covered by SiriusXM Traffic and Travel Link.

Note: Neither Sirius nor Ford is responsible for any errors or inaccuracies in the SiriusXM Traffic and Travel Link services or its use in vehicles.

When you subscribe to SiriusXM Traffic and Travel Link, it can help you locate the best gas prices, find movie listings, get current traffic alerts, view the current weather map, get accurate ski conditions and see scores to current sports games.

Menu Item	Action and Description	
Traffic on Route	Touch these buttons to identify traffic incidents on your route, near your vehicle's current location or near any of your favorite places, if programmed.	
Traffic Nearby		
Fuel Prices	Touch this button to view fuel prices at stations close to your vehicle's location or on an active navigation route.	
Movie Listings	Touch this button to view nearby movie theaters and their show times, if available.	
Weather	Touch this button to view the nearby weather, current weather, or the five-day forecast for the chosen area.	
	Map	Select to see the weather map, which can show storms, radar information, charts and winds.

SYNC™ 3

Menu Item	Action and Description	
	Area	Select to choose from a listing of weather locations.
Sports Info	Touch this button to view scores and schedules from a variety of sports. You can also save up to 10 favorite teams for easier access. The score automatically refreshes when a game is in progress.	
Ski Conditions	Touch this button to view ski conditions for a specific area.	

SETTINGS



Press the button to enter the settings menu.



Once you select a tile, press the button next to a menu item to view an explanation of the feature or setting.

Sound

Select this tile to adjust the sound settings.

Clock

Select this tile to adjust the clock settings.

Bluetooth®

Select this tile to switch **Bluetooth®** on and off and adjust the settings.

Phone

Select this tile to connect, disconnect, and manage the connected device settings.

Audio

Select this tile to adjust the audio settings.

Driver Assist (If Equipped)

Select this tile to adjust Driver Assist features like Parking Aids, Lane Keeping System, Pedestrian Detection, and Auto-Start-Stop.

Vehicle

Select this tile to adjust vehicle settings like windows, alarm, lighting, and MyKey settings.

FordPass (If Equipped)

Select this tile to adjust the FordPass settings.

General

Select this tile to adjust settings like language, measurement units, or to reset the system.

911 Assist (If Equipped)

Select this tile to switch 911 Assist on and off.

Automatic Updates

Select this tile to adjust the automatic update settings.

Mobile Apps

Select this tile to adjust permissions, enable, disable, and update mobile apps.

Display

Select this tile to adjust display settings like brightness and auto dim.

Charge Settings (If Equipped)

Select this tile to adjust the electric vehicle charge settings.

Voice Control

Select this tile to adjust voice control settings like command confirmations and displayed lists.

Navigation (If Equipped)

Select this tile to adjust navigation settings like map preferences and route guidance.

Seats (If Equipped)

Select this tile to adjust the lumbar function and massage function of your multi contour seats.

Message Center (If Equipped)

Select this tile to view vehicle messages.

Personal Profiles (If Equipped)

Select this tile to adjust recalled memory features when using personal profiles.

Valet Mode (If Equipped)

Select this tile to enable and disable valet mode.

Ambient Lighting (If Equipped)

Select this tile to change the color or intensity of the interior lighting.

SYNC™ 3 TROUBLESHOOTING

Voice Recognition

Symptom	Possible Cause and Resolution
The system does not understand what I am saying.	<ul style="list-style-type: none"> – You might not be using supported voice commands. <ul style="list-style-type: none"> • See Using Voice Recognition (page 429). • For a complete list of voice commands, refer to our website. – You might be speaking too soon. <ul style="list-style-type: none"> • Wait for the voice prompt before you speak.
The system does not understand the name of a track or artist.	<ul style="list-style-type: none"> – Device limitation. Bluetooth® does not support voice commands. <ul style="list-style-type: none"> • Connect your device to a USB port. • If you have an iOS device, press and hold the voice control button on the steering wheel to use Siri to play specific tracks. – You might not be using supported voice commands. <ul style="list-style-type: none"> • See Using Voice Recognition (page 429). • For a complete list of voice commands, refer to our website. – You might not be saying the name exactly as it appears on your device. <ul style="list-style-type: none"> • Say the name of the track or artist exactly as it appears on your device. Spell out any abbreviations in the name. – The name contains special characters, for example *, - or +. <ul style="list-style-type: none"> • Rename the files on your device or use the touchscreen to select and play the track.
The system does not understand the name of a contact in the phonebook on my device and calls the wrong contact.	<ul style="list-style-type: none"> – You might not be saying the name exactly as it appears on your device. <ul style="list-style-type: none"> • Say the first and last name of the contact exactly as it appears on your device. Spell out any abbreviations in the name. – The name contains special characters, for example *, - or +. <ul style="list-style-type: none"> • Rename the contact on your device or use the touchscreen to select and call the contact.

SYNC™ 3

Symptom	Possible Cause and Resolution
The system does not understand certain names of contacts in the phonebook on my device.	<ul style="list-style-type: none">– You might not be saying the name exactly as it appears on your device.<ul style="list-style-type: none">• Say the first and last name of the contact exactly as it appears on your device. The system applies phonetic pronunciation rules of the selected language to the names of contacts in the phonebook on your device. Select the name of the contact on the touchscreen and use the Hear it option to get an idea of how the system expects you to pronounce it.
The system voice prompts and the pronunciation of some words do not seem to be very accurate.	<ul style="list-style-type: none">– Device limitation.<ul style="list-style-type: none">• The system uses text-to-speech technology and uses a synthetically generated voice rather than pre-recorded human voice.

USB and Bluetooth® Audio

Symptom	Possible Cause and Resolution
I cannot connect my device.	<ul style="list-style-type: none">– Device malfunction.<ul style="list-style-type: none">• Disconnect your device. Switch your device off and on to reset it and try again.– Cable connection issue.<ul style="list-style-type: none">• Correctly connect the cable to your device and the vehicle USB port.– Incompatible cable.<ul style="list-style-type: none">• Use the cable recommended by the manufacturer of your device.

SYNC™ 3

Symptom	Possible Cause and Resolution
	<ul style="list-style-type: none"> – Incorrect device settings. <ul style="list-style-type: none"> • Make sure that your device does not have an auto-install program or active security settings. • Check that your device is not set only to charge. – Device lock screen enabled. <ul style="list-style-type: none"> • Unlock your device before connecting it.
<p>The system does not recognize my device.</p>	<ul style="list-style-type: none"> – Device limitation. <ul style="list-style-type: none"> • Do not leave your device in your vehicle during very hot or very cold weather conditions. – Cable connection issue. <ul style="list-style-type: none"> • Correctly connect the cable to your device and the vehicle USB port. – Incompatible cable. <ul style="list-style-type: none"> • Use the cable recommended by the manufacturer of your device.
<p>The system does not understand the name of a track or artist.</p>	<ul style="list-style-type: none"> – Device limitation. Bluetooth® does not support voice commands. <ul style="list-style-type: none"> • Connect your device to a USB port. • If you have an iOS device, press and hold the voice control button on the steering wheel to use Siri to play specific tracks.
<p>I cannot stream audio from my Bluetooth® device.</p>	<ul style="list-style-type: none"> – Incompatible device. <ul style="list-style-type: none"> • Check the compatibility of your device on our website. – Device not connected. <ul style="list-style-type: none"> • Pair your device. See Phone (page 447). – Media player not running. <ul style="list-style-type: none"> • Start the media player on your device.
<p>The system does not recognize the music on my device.</p>	<ul style="list-style-type: none"> – Missing or incorrect audio file metadata, for example artist, song title, album or genre. <ul style="list-style-type: none"> • Repair the files on your device. – Corrupt files. <ul style="list-style-type: none"> • Repair the files on your device.

SYNC™ 3

Symptom	Possible Cause and Resolution
	<ul style="list-style-type: none"> – Copyright-protected files. <ul style="list-style-type: none"> • Use a device that contains files that are not copyright protected. – Unsupported file format. <ul style="list-style-type: none"> • Repair or convert the files to a supported format. See Entertainment (page 435). – Device indexing required. <ul style="list-style-type: none"> • Re-index your device. See Settings (page 458). – Device lock screen enabled. <ul style="list-style-type: none"> • Unlock your device before connecting it.
Sometimes I cannot hear a track playing on my device.	<ul style="list-style-type: none"> – Device malfunction. <ul style="list-style-type: none"> • Disconnect your device. Switch your device off and on to reset it and try again.
When I disconnect my iOS device the audio volume is set to maximum.	<ul style="list-style-type: none"> – Device limitation. <ul style="list-style-type: none"> • Turn the volume down on your device.
The system does not play the tracks on my USB drive in the correct order.	<p>If the system does not play the tracks on your USB device in the correct order, the following information could help:</p> <ul style="list-style-type: none"> – If you are selecting USB as the audio source when the system is still indexing, SYNC plays tracks sorted alphabetically by file name in the root directory. – If you are selecting USB as the audio source after the system has finished indexing, SYNC plays all tracks sorted alphabetically by the title in the ID3 tag regardless of where they are located. SYNC uses the file name if the title in the ID3 tag does not exist. – If you are selecting the option to play all tracks from the browsing menu, SYNC plays all tracks sorted alphabetically by the title in the ID3 tag regardless of where they are located. SYNC uses the file name if the title in the ID3 tag does not exist. – If you are selecting a track when using the explore device option, SYNC plays tracks sorted alphabetically by file name in the folder you have selected. SYNC then plays all tracks in any subfolders in the folder you have selected.

SYNC™ 3

Phone

Symptom	Possible Cause and Resolution
During a call, I can hear excessive background noise.	<ul style="list-style-type: none"> - Incorrect cell phone settings. <ul style="list-style-type: none"> • Check and adjust the audio settings on your cell phone. Refer to your cell phone's user manual.
During a call, I can hear the other person but they cannot hear me.	<ul style="list-style-type: none"> - Cell phone malfunction. <ul style="list-style-type: none"> • Switch your cell phone on and off, and vehicle Bluetooth® on and off and try again. - Cell phone microphone muted. <ul style="list-style-type: none"> • Unmute your cell phone microphone. - Privacy mode is enabled. <ul style="list-style-type: none"> • Switch off privacy mode.
During a call, I cannot hear the other person and they cannot hear me.	<ul style="list-style-type: none"> - System restart required. <ul style="list-style-type: none"> • Switch the ignition off and open the door. Close the door and lock the vehicle. Wait until the touchscreen is off and any illuminated USB ports are not illuminated. Unlock the vehicle, switch the ignition on and try again.
I cannot download a phone-book.	<ul style="list-style-type: none"> - Incompatible cell phone. <ul style="list-style-type: none"> • Check the compatibility of your cell phone on our website. - Incorrect cell phone settings. <ul style="list-style-type: none"> • Allow the system to retrieve contacts from your cell phone. Refer to your cell phone's user manual. - Incorrect system settings. <ul style="list-style-type: none"> • Switch automatic phonebook download on. See Settings (page 458). - Cell phone malfunction. <ul style="list-style-type: none"> • Switch your cell phone off and on to reset it and try again.

SYNC™ 3

Symptom	Possible Cause and Resolution
<p>A message displays suggesting that my phonebook has downloaded but it is empty or it has missing contacts.</p>	<ul style="list-style-type: none"> – Incorrect cell phone settings. <ul style="list-style-type: none"> • Allow the system to retrieve contacts from your cell phone. Refer to your cell phone's user manual. • Check the location of the missing contacts on your cell phone. If they are stored on the SIM card, move them to the cell phone memory. – Incorrect system settings. <ul style="list-style-type: none"> • Switch automatic phonebook download on. See Settings (page 458).
<p>I cannot connect my cell phone.</p>	<ul style="list-style-type: none"> – Incompatible cell phone. <ul style="list-style-type: none"> • Check the compatibility of your cell phone on our website. – Cell phone malfunction. <ul style="list-style-type: none"> • Switch your cell phone off and on to reset it and try again. • Install the latest cell phone firmware. • Delete your device from the system and delete SYNC from your device and try again. • Switch automatic phonebook download off. See Settings (page 458).
<p>Text messaging does not work.</p>	<ul style="list-style-type: none"> – You might not have switched on text message notifications. <ul style="list-style-type: none"> • Switch text message notifications on. See Phone (page 447). – Incompatible cell phone. <ul style="list-style-type: none"> • Check the compatibility of your cell phone on our website. – Cell phone malfunction. <ul style="list-style-type: none"> • Switch your cell phone off and on to reset it and try again.
<p>I cannot hear text messages.</p>	<ul style="list-style-type: none"> – Device message sharing is not enabled. <ul style="list-style-type: none"> • Check the permissions on your device to ensure text message sharing is enabled. – Incompatible cell phone. <ul style="list-style-type: none"> • Check the compatibility of your cell phone on our website.

SYNC™ 3

Navigation (If Equipped)

Symptom	Possible Cause and Resolution
I cannot enter a street name when I am abroad.	<ul style="list-style-type: none">- Incorrect entry method.<ul style="list-style-type: none">• Enter the street name with the country.
The system does not recognize coordinates.	<ul style="list-style-type: none">- Using the wrong coordinates format.<ul style="list-style-type: none">• Use the format ##. #####, ##. ##### (for N/S, E/W). Add a minus before coordinates if the direction is West and keep a positive value if the direction is East, for example 12.5412 means East and -12.5412 means West.

SYNC™ 3

Apps

Symptom	Possible Cause and Resolution
The system cannot find any apps.	<ul style="list-style-type: none">– Incompatible device.<ul style="list-style-type: none">• You need an Android device with OS 4.3 or higher or an iOS device with iOS 8.0 or higher. Pair and connect your Android device to find compatible apps. Connect your iOS device to a USB port or pair and connect using Bluetooth®.
I have a compatible device and it is correctly connected but the system still cannot find any apps.	<ul style="list-style-type: none">– Compatible apps are not installed on your device.<ul style="list-style-type: none">• Download and install the latest version of the app.– Compatible apps are not running on your device.<ul style="list-style-type: none">• Start the apps to allow the system to find them and make sure you sign in to any apps if required.– Incorrect app settings.<ul style="list-style-type: none">• Check and adjust the app settings on your device and allow SYNC to access the app if required.
I have a compatible device, it is correctly connected and my apps are running but the system still cannot find any apps.	<ul style="list-style-type: none">– Apps failed to fully close.<ul style="list-style-type: none">• Restart the apps and try again.• If you have an Android device with apps that have an exit or quit option, use this and then restart the apps. Alternatively, use the force stop option in the settings menu on your device.• If you have an iOS device with iOS 8.0 or higher, tap the home button on your device twice and then swipe the app upward to close it.
I have an Android device that is correctly connected, I have restarted my apps and they are running but the system still cannot find them.	<ul style="list-style-type: none">– An issue on some older versions of the Android operating system could result in apps not being found.<ul style="list-style-type: none">• Switch Bluetooth® off and on again to force the system to reconnect to your device.

SYNC™ 3

Symptom	Possible Cause and Resolution
I have an iOS device that is correctly connected, I have restarted my apps and they are running but the system still cannot find them.	<ul style="list-style-type: none">- Cable connection issue.<ul style="list-style-type: none">• Disconnect the cable from your device, wait for a moment and then connect it again to force the system to reconnect to your device.
I have an Android device running a media app which the system has found but I cannot hear the sound or the sound is very quiet.	<ul style="list-style-type: none">- Device volume is low.<ul style="list-style-type: none">• Turn the volume up on your device.
I have an Android device running a number of compatible apps but the system cannot find all of them.	<ul style="list-style-type: none">- Device limitation. If you have more apps running on your device than the number of available Bluetooth® links, the system cannot find all of them.<ul style="list-style-type: none">• Close some of the apps to allow the system to find those that you want to use.

Wi-Fi Connectivity

Symptom	Possible Cause and Resolution
I cannot connect to a Wi-Fi network.	<ul style="list-style-type: none"> – Password error. <ul style="list-style-type: none"> • Enter the correct network password. – Weak network signal. <ul style="list-style-type: none"> • Move your vehicle closer to the Wi-Fi hotspot or to a place where the network signal is not obstructed. – Multiple access points in range with the same SSID. <ul style="list-style-type: none"> • Use a unique name for your SSID. Do not use the default name unless it contains a unique identifier, for example as part of the MAC address.
The Wi-Fi connection disconnects after successful connection.	<ul style="list-style-type: none"> – Weak network signal. <ul style="list-style-type: none"> • Move your vehicle closer to the Wi-Fi hotspot or to a place where the network signal is not obstructed.
I am close to a Wi-Fi hotspot but the network signal strength is weak.	<ul style="list-style-type: none"> – Obstructed network signal. <ul style="list-style-type: none"> • If your vehicle has a heated windshield, position your vehicle so that the windshield is not facing the Wi-Fi hotspot. • If your vehicle has metallic tinting on the windows but not on the windshield, position your vehicle so that the windshield is facing the Wi-Fi hotspot or open the windows that are facing the hotspot. • If your vehicle has metallic tinting on the windows and the windshield, open the windows that are facing the hotspot. • If your vehicle is in a garage and you have the garage door closed, open the garage door.
I cannot see a network in the list of available networks that I expect to see.	<ul style="list-style-type: none"> – Hidden network. <ul style="list-style-type: none"> • Make the network visible and try again.

SYNC™ 3

Symptom	Possible Cause and Resolution
I cannot see SYNC when I search for Wi-Fi networks on my cell phone or other device.	<ul style="list-style-type: none"> – System limitation. <ul style="list-style-type: none"> • SYNC does not provide a Wi-Fi hotspot at this time.
Software downloads take too long.	<ul style="list-style-type: none"> – Weak network signal <ul style="list-style-type: none"> • Move your vehicle closer to the Wi-Fi hotspot or to a place where the network signal is not obstructed. – Wi-Fi hotspot in high demand or has a slow Internet connection. <ul style="list-style-type: none"> • Use a more reliable Wi-Fi hotspot.
The system seems to connect to a Wi-Fi network and the signal strength is excellent but the software does not update.	<ul style="list-style-type: none"> – No software update available. – Wi-Fi network requires a subscription or acceptance of terms and conditions. <ul style="list-style-type: none"> • Test the connection using another device. If the network requires a subscription or acceptance of terms and conditions, contact the network service provider.

Personal Profiles (If Equipped)

Symptom	Possible Cause and Resolution
I cannot create a profile.	You might not have set up Personal Profiles.
	You might have entered an invalid profile.
	You might not have selected a memory button when prompted.
	You might not have the ignition on or in park (P), or you shifted out park (P) when creating a profile.
	Personal Profiles has been switched off.
I cannot link a remote control.	You might not have selected the lock button on the remote control.
	The remote control selected was already associated with another profile and the system declined to overwrite.
	The system performed a profile recall when linking a remote control.

SYNC™ 3

Symptom	Possible Cause and Resolution
	<p>You might not have the ignition on or in park (P), or you shifted out park (P) when creating a profile.</p> <p>You might be using the old linking method.</p>
My personalized settings do not save.	<p>Personal Profiles does not support your unsaved settings.</p> <p>A different personal profile is active.</p> <p>Another user changed the settings for the wrong personal profile.</p>
My profile will not recall.	<p>You might not have created a personal profile.</p> <p>Personal Profiles is turned off.</p> <p>The profile you requested is already active.</p> <p>You might not have linked the memory button you are using to a profile.</p> <p>You might not have linked the remote control you are using to a profile.</p> <p>You might be using the wrong remote control.</p> <p>You might be pressing a button other than the unlock or remote start on a linked remote control.</p> <p>You might have deleted the personal profile.</p>
My preset positions recall, but my profile does not.	<p>Personal Profiles is turned off.</p>
My profile recalls but my preset positions do not.	<p>The vehicle is in motion.</p> <p>The preset positions are the same as the guest or previously active profile.</p>
I lost a remote control.	<p>Unlink and relink your remote control in the Personal Profiles menu. You may need to see your authorized dealer.</p>
I lost all profiles.	<p>You might have erased and reprogrammed the remote controls. This could happen if you let a dealership add a new remote control to replace a lost one.</p> <p>Someone performed a master reset.</p>

Resetting the System

1. Simultaneously press and hold the seek up and the audio unit power buttons until the screen goes black.
2. Wait three minutes to allow the system to complete the reset.
3. Press the audio unit power button to switch the system on.

Note: *You can reset the system to restore functionality that has stopped working. The system reset is designed to restore functionality and not delete any data that you have stored.*

Additional Information and Assistance

For additional information and assistance, we recommend that you contact an authorized dealer or refer to our website.

Accessories

For a complete listing of the accessories that are available for your vehicle, please contact your authorized dealer or visit the online store web site:

Web Address (United States)
www.Accessories.Ford.com

Web Address (Canada)
www.Accessories.Ford.ca

We will repair or replace any properly authorized dealer-installed Ford Original Accessory found to be defective in factory-supplied materials or workmanship during the warranty period, as well as any component damaged by the defective accessories.

We will warrant your Ford Original Accessory through the warranty that provides the greatest benefit:

- 24 months, unlimited mileage.
- The remainder of your new vehicle limited warranty.

Contact an authorized dealer for details and a copy of the warranty.

Ford Licensed Accessories are the accessory manufacturer's designs. The manufacturer develops and therefore warrants Ford Licensed Accessories, and does not design or test these accessories to Ford Motor Company engineering requirements. Contact an authorized Ford dealer for the manufacturer's limited warranty details, and request a copy of the Ford Licensed Accessories product limited warranty from the accessory manufacturer.

For maximum vehicle performance, keep the following information in mind when adding accessories or equipment to your vehicle:

- When adding accessories, equipment, passengers and luggage to your vehicle, do not exceed the total weight capacity of the vehicle or of the front or rear axle (GVWR or GAWR as indicated on the Safety Compliance Certification label). Ask an authorized dealer for specific weight information.
- The Federal Communications Commission (FCC) and Canadian Radio Telecommunications Commission (CRTC) regulate the use of mobile communications systems that are equipped with radio transmitters, for example two-way radios, telephones and theft alarms. Any such equipment installed in your vehicle should comply with Federal Communications Commission (FCC) and Canadian Radio Telecommunications Commission (CRTC) regulations and should be installed only by an authorized dealer.
- An authorized dealer needs to install mobile communications systems. Improper installation may harm the operation of your vehicle, particularly if the manufacturer did not design the mobile communication system specifically for automotive use.
- If you or an authorized Ford dealer add any non-Ford electrical or electronic accessories or components to your vehicle, you may adversely affect battery performance and durability. In addition, you may also adversely affect the performance of other electrical systems in the vehicle.

Ford Protect

PROTECT YOURSELF FROM THE RISING COST OF VEHICLE REPAIRS WITH A FORD PROTECT EXTENDED SERVICE PLAN.

Ford Protect Extended Service Plans (U.S. Only)

Ford Protect extended service plan means peace of mind. It is the extended service plan backed by Ford Motor Company, and provides more protection beyond the New Vehicle Limited Warranty coverage. When you visit your Ford Dealer, Insist on Ford Protect extended service plans!

Ford Protect Can Quickly Pay for Itself

One trip to the Service Center could easily exceed the price of your Ford Protect extended service plan. With Ford Protect extended service plan you minimize your risk for unexpected repair bills and rising repair costs.

Up to 1,000+ Covered Vehicle Components

There are four mechanical Ford Protect extended service plans with different levels of coverage. Ask your authorized dealer for details.

1. PremiumCARE - Our most comprehensive coverage. With over 1,000 covered components, this plan is so complete it is probably easier to list what is not covered.
2. ExtraCARE - Covers 113 components, and includes many high-tech items.
3. BaseCARE - Covers 84 components.
4. PowertrainCARE - Covers 29 critical components.

Ford Protect extended service plans are honored by all authorized Ford dealers in the U.S., Canada and Mexico.

That means you get:

- Reliable, quality service at any Ford or Lincoln dealership.
- Repairs performed by factory trained technicians, using genuine parts.

Rental Car Reimbursement

1st day Rental Benefit

If you bring your car into your dealer for service, we'll give you a loaner to use for the day.

Extended Rental Benefits

If your vehicle is kept overnight for covered repairs, you are eligible for rental car coverage, including warranty repairs, and Field Service Actions.

Roadside Assistance

Exclusive 24/7 roadside assistance, including:

- Towing, flat-tire change and battery jump starts.
- Out of fuel and lock-out assistance.
- Travel expense reimbursement for lodging, meals and rental car.
- Assistance for taxi, shuttle, rental car coverage or other transportation.

Transferable Coverage

If you sell your vehicle before your Ford Protect extended service plan coverage expires, you can transfer any remaining coverage to the new owner. Which should give you and your potential buyer a little more peace of mind.

Ford Protect

Less Cost to Properly Maintain Your Vehicle

Ford Protect extended service plan also offers a Premium Maintenance Plan that covers all scheduled maintenance, and selected wear items. The coverage is prepaid, so you never have to worry about the cost of your vehicle's maintenance.

Covered maintenance includes:

- Windshield wiper blades.
- Spark plugs.
- The clutch disc (if equipped).
- Brake pads and linings.
- Shock absorbers.
- Struts.
- Engine belts.
- Engine coolant hoses, clamps and O-rings.
- Diesel exhaust fluid replenishment (if equipped).
- Cabin air filter replacement every 20,000 mi (32,000 km) (electric vehicles only).

Interest Free Finance Options

Just a 5% down payment will provide you with an affordable, no interest, no fee payment program allowing you all the security and benefits Ford Protect extended service plan has to offer while paying over time. You are pre-approved with no credit check or hassles. To learn more, call our Ford Protect extended service plan specialists at 800-367-3377.

Ford Protect Extended Service Plan
P.O. Box 321067
Detroit, MI 48232

Ford Protect Extended Service Plan (CANADA ONLY)

You can get more protection for your vehicle by purchasing a Ford Protect extended service plan. Ford Protect extended service plan is the only service contract backed by Ford Motor Company of Canada, Limited. Depending on the plan you purchase, Ford Protect extended service plan provides benefits such as:

- Rental reimbursement.
- Coverage for certain maintenance and wear items.
- Protection against repair costs after your New Vehicle Limited Warranty Coverage expires.
- Roadside Assistance benefits.

There are several Ford Protect extended service plans available in various time, distance and deductible combinations. Each plan is tailored to fit your own driving needs, including reimbursement for towing and rental. When you purchase Ford Protect extended service plan, you receive added peace-of-mind protection throughout Canada, the United States and Mexico, provided by a network of participating authorized Ford Motor Company dealers.

Note: *Repairs performed outside of Canada and the United States are not eligible for Ford Protect extended service plan coverage.*

This information is subject to change. For more information; visit your local Ford of Canada dealer or www.ford.ca to find the Ford Protect extended service plan that is right for you.

Scheduled Maintenance

GENERAL MAINTENANCE INFORMATION

Why Maintain Your Vehicle?

Carefully following the maintenance schedule helps protect against major repair expenses resulting from neglect or inadequate maintenance and may help to increase the value of your vehicle when you sell or trade it. Keep all receipts for completed maintenance with your vehicle.

We have established regular maintenance intervals for your vehicle based upon rigorous testing. It is important that you have your vehicle serviced at the proper times. These intervals serve two purposes: one is to maintain the reliability of your vehicle and the second is to keep your cost of owning your vehicle down.

It is your responsibility to have all scheduled maintenance performed and to make sure that the materials used meet the specifications identified in this owner's manual. See **Capacities and Specifications** (page 378).

Failure to perform scheduled maintenance invalidates warranty coverage on parts affected by the lack of maintenance.

Why Maintain Your Vehicle at Your Dealership?

Factory-Trained Technicians

Service technicians participate in extensive factory-sponsored certification training to help them become experts on the operation of your vehicle. Ask your dealership about the training and certification their technicians have received.

Our Genuine Replacement Parts

Dealerships stock our genuine manufactured or our authorized re-manufactured replacement parts. These parts meet or exceed our specifications. Parts installed at your dealership carry a nationwide 24-month or unlimited mile (kilometer) parts and labor limited warranty.

If you do not use our authorized parts they may not meet our specifications and depending on the part, it could affect emissions compliance.

Convenience

Many dealerships have extended evening and Saturday hours to make your service visit more convenient and they offer one stop shopping. They can perform any services that are required on your vehicle, from general maintenance to collision repairs.

Note: *Not all dealers have extended hours or body shops. Please contact your dealer for details.*

Protecting Your Investment

Maintenance is an investment that pays dividends in the form of improved reliability, durability and resale value. To maintain the proper performance of your vehicle and its emission control systems, make sure you have scheduled maintenance performed at the designated intervals.

Your vehicle has an Intelligent Oil-Life Monitor system; a message appears in the instrument cluster display at the proper oil change interval. This interval may be up to one year or 10,000 mi (16,000 km), hybrid vehicles may exceed 10,000 mi (16,000 km).

Scheduled Maintenance

Your vehicle can be driven in such a way that dilutes and increases the level of oil by short trips that do not allow the engine to get to operating temperature, extended idling, and low speed driving for long periods of time.

When the oil change message appears in the instrument cluster display, it is time for an oil change. Make sure you perform the oil change within two weeks or 500 mi (800 km) of the message appearing. Make sure you reset the Intelligent Oil-Life Monitor after each oil change. See **Oil Change Indicator Reset** (page 320).

If your instrument cluster display resets prematurely or becomes inoperative, you should perform the oil change interval at six months or 5,000 mi (8,000 km) from your last oil change. Never exceed one year or 10,000 mi (16,000 km) between oil change intervals.

Your vehicle is very sophisticated and built with multiple, complex performance systems. Every manufacturer develops these systems using different specifications and performance features. That is why it is important to rely upon your dealership to properly diagnose and repair your vehicle.

We have recommended maintenance intervals for various parts and component systems based upon engineering testing. We rely upon this testing to determine the most appropriate mileage for replacement of oils and fluids to protect your vehicle at the lowest overall cost to you and recommends against maintenance schedules that deviate from the scheduled maintenance information.

We strongly recommend the use of only our genuine manufactured or our authorized re-manufactured replacement parts engineered for your vehicle.

Additives and Chemicals

This owner's manual and our Workshop Manual list the recommended additives and chemicals for your vehicle. We do not recommend using chemicals or additives not approved by us as part of your vehicle's normal maintenance. Please consult your warranty information.

Oils, Fluids and Flushing

In many cases, fluid discoloration is a normal operating characteristic and, by itself, does not necessarily indicate a concern or that the fluid needs to be changed. However, a qualified expert, such as the factory-trained technicians at your dealership, should inspect discolored fluids that also show signs of overheating or foreign material contamination immediately.

Make sure to change your vehicle's oils and fluids at the specified intervals or in conjunction with a repair. Flushing is a viable way to change fluid for many vehicle sub-systems during scheduled maintenance. It is critical that systems are flushed only with new fluid that is the same as that required to fill and operate the system or using our approved flushing chemical.

Owner Checks and Services

Make sure you perform the following basic maintenance checks and inspections every month or at six-month intervals.

Scheduled Maintenance

Check Every Month
Engine oil level.
Function of all interior and exterior lights.
Tires (including spare) for wear and proper pressure.
Windshield washer fluid level.
Holes and slots in the tail pipe to make sure they are functional and clear of debris.

Check Every Six Months
Battery connections. Clean if necessary.
Body and door drain holes for obstructions. Clean if necessary.
Cooling system fluid level and coolant strength.
Door weatherstrips for wear. Lubricate if necessary.
Hinges, latches and outside locks for proper operation. Lubricate if necessary.
Parking brake for proper operation.
Seatbelts and seat latches for wear and function.
Safety warning lamps (brake, ABS, airbag and seatbelt) for operation.
Washer spray and wiper operation. Clean or replace blades as necessary.

Multi-Point Inspection

In order to keep your vehicle running right, it is important to have the systems on your vehicle checked regularly. This can help identify potential issues and prevent major problems. We recommend having the following multi-point inspection performed at every scheduled maintenance interval to help make sure your vehicle keeps running great.

Scheduled Maintenance

Multi-Point Inspection	
Accessory drive belt(s)	Hazard warning system operation
Battery performance	Horn operation
Engine air filter	Radiator, cooler, heater and air conditioning hoses
Exhaust system	Suspension components for leaks or damage
Exterior lamps operation	Steering and linkage
Fluid levels ¹ ; fill if necessary	Tires (including spare) for wear and proper pressure ²
For oil and fluid leaks	Windshield for cracks, chips or pits
Half-shaft dust boots	Washer spray and wiper operation

¹ Brake, coolant recovery reservoir, automatic transmission and window washer

² If your vehicle is equipped with a temporary mobility kit, check the tire sealant expiration Use By date on the canister. Replace as needed.

Be sure to ask your dealership service advisor or technician about the multi-point vehicle inspection. It is a comprehensive way to perform a thorough inspection of your vehicle. Your checklist gives you immediate feedback on the overall condition of your vehicle.

NORMAL SCHEDULED MAINTENANCE

Intelligent Oil-Life Monitor™

Your vehicle has an Intelligent Oil-Life Monitor that determines when you should change the engine oil based on how you use your vehicle. By using several important factors in its calculations, the monitor helps reduce the cost of owning your vehicle and reduces environmental waste at the same time.

This means you do not have to remember to change the oil on a mileage-based schedule. Your vehicle lets you know when an oil change is due by displaying a message in the information display.

The following table provides examples of vehicle use and its impact on oil change intervals. It is a guideline only. Actual oil change intervals depend on several factors and generally decrease with severity of use.

Scheduled Maintenance

When to Expect the OIL CHANGE REQUIRED Message	
Interval¹	Vehicle Use and Example
7,500–10,000 mi (12,000–16,000 km)	Normal
	Normal commuting with highway driving No, or moderate, load or towing Flat to moderately hilly roads No extended idling
5,000–7,500 mi (8,000–12,000 km)	Severe
	Moderate to heavy load or towing Mountainous or off-road conditions Extended idling Extended hot or cold operation
3,000–5,000 mi (4,800–8,000 km)	Extreme
	Maximum load or towing Extreme hot or cold operation Extended engine idling

¹ Hybrid vehicles may achieve longer distances between oil changes, but do not exceed the 1 year maximum oil change interval. Remaining oil life can be accessed through the information display. See **Information Displays** (page 110).

Normal Maintenance Intervals

At Every Oil Change Interval as Indicated by the Information Display¹
Change the engine oil and filter. ²
Rotate the tires.
Perform a multi-point inspection, recommended.
Inspect the brake pads, rotors, hoses and parking brake.
Inspect the engine cooling system strength and hoses.
Inspect the exhaust system and heat shields.
Inspect the front axle.
Inspect the rear axle and U-joints.
Inspect the half-shaft boots.

Scheduled Maintenance

At Every Oil Change Interval as Indicated by the Information Display¹

Inspect the steering linkage, ball joints, suspension and the tire-rod ends.

Inspect the tires, tire wear and measure the tread depth.

Inspect the wheels and related components for abnormal noise, wear, looseness or drag.

¹ Do not exceed one year or 10,000 mi (16,000 km) between service intervals.

² Reset the Intelligent Oil-Life Monitor after engine oil and filter changes. See **Engine Oil Check** (page 319).

Brake Fluid Maintenance¹

Every Three Years

Change the brake fluid.²

¹ Perform this maintenance item every three years. Do not exceed the designated time for the interval.

² Brake fluid servicing requires special equipment available at your authorized dealer.

Other Maintenance Items¹

Every 20,000 mi
(32,000 km)

Replace the cabin air filter.

Every 30,000 mi
(48,000 km)

Replace the engine air filter.

At 200,000 mi
(322,000 km)

Change the engine coolant and motor electronics coolant.²

Every 100,000 mi
(160,000 km)

Replace the spark plugs.

Every 100,000 mi
(160,000 km)

Inspect the accessory drive belt or belts.³

Scheduled Maintenance

Other Maintenance Items ¹	
Every 150,000 mi (240,000 km)	Change the automatic transmission fluid.
	Replace the accessory drive belt or belts. ⁴

¹ Perform these maintenance items within 3,000 mi (4,800 km) of the last engine oil and filter change. Do not exceed the designated distance for the interval.

² Initial replacement at 10 years or 200,000 mi (322,000 km), then every 5 years or 100,000 mi (160,000 km).

³ After initial inspection, inspect every other oil change until replaced.

⁴ If not replaced within the last 100,000 mi (160,000 km).

SPECIAL OPERATING CONDITIONS SCHEDULED MAINTENANCE

If you operate your vehicle primarily in any of the following conditions, you need to perform extra maintenance as indicated. If you operate your vehicle occasionally under any of these conditions, it is not necessary to perform the extra maintenance. For specific recommendations, see your dealership service advisor or technician.

Perform the services shown in the following tables when specified or within 3,000 mi (4,800 km) of the message appearing in the instrument cluster display prompting you to change your oil.

- Example 1: The message comes on at 28,750 mi (46,270 km). Perform the 30,000 mi (48,000 km) automatic transmission fluid replacement.
- Example 2: The message has not come on, but the odometer reads 30,000 mi (48,000 km) (for example, the Intelligent Oil-Life Monitor was reset at 25,000 mi (40,000 km). Perform the engine air filter replacement.

Towing a Trailer or Using a Car-top Carrier	
As required	Change engine oil and filter as indicated by the instrument cluster display and perform services listed in the Normal Scheduled Maintenance chart.
Inspect frequently, service as required	Inspect front axle.
	Inspect rear axle and U-joints.
	Inspect half-shaft boots.
	See axle maintenance items under Exceptions.
Every 60,000 mi (96,000 km)	Replace spark plugs.

Scheduled Maintenance

Extensive Idling or Low-speed Driving for Long Distances, as in Heavy Commercial Use (Such as Delivery, Taxi, Patrol Car or Livery) Short Trips that do not allow the engine to get to operating temperature causing fuel dilution and an increase of the engine oil level	
As required	Change engine oil and filter as indicated by the instrument cluster display and perform services listed in the Normal Scheduled Maintenance chart.
Inspect frequently, service as required	Replace cabin air filter.
	Replace engine air filter.
Every 60,000 mi (96,000 km)	Replace spark plugs.

Operating in Dusty or Sandy Conditions - Such as Unpaved or Dusty Roads	
Inspect frequently, service as required	Replace cabin air filter.
	Replace engine air filter.
Every 5,000 mi (8,000 km)	Inspect the wheels and related components for abnormal noise, wear, looseness or drag.
	Rotate tires, inspect tires for wear and measure tread depth.
Every 5,000 mi (8,000 km) or six months	Change engine oil and filter. ¹
	Perform multi-point inspection.

¹Reset your Intelligent Oil-Life Monitor after engine oil and filter changes. See **Oil Change Indicator Reset** (page 320).

Exclusive use of E85 - Flex Fuel Vehicles Only	
Every oil change	If ran exclusively on E85, fill the fuel tank full with regular unleaded fuel.

Exceptions

There are several exceptions to the Normal Schedule:

Scheduled Maintenance

Axle and Transfer Case Maintenance

The transfer case, front and rear axles in your vehicle do not require normal scheduled maintenance. Your vehicle is electronically monitored and notifies you of required service by displaying a message in the instrument cluster display. The transfer case, front and rear axles are more likely to require a fluid change if the vehicle has experienced extended periods of extreme or severe duty cycle driving. Changing or checking the transfer case, front and/or rear axle lubricant is not necessary unless the unit has been submerged in water, shows signs of leakage, a message indicating required service displays. Contact your authorized dealer for service.

California Fuel Filter Replacement

If you register your vehicle in California, the California Air Resources Board has determined that the failure to perform this maintenance item does not nullify the emission warranty or limit recall liability before the completion of your vehicle's useful life. Ford Motor Company, however, urges you to have all recommended maintenance services performed at the specified intervals and to record all vehicle service.

Hot Climate Oil Change Intervals

Vehicles operating in the Middle East, North Africa, Sub-Saharan Africa or locations with similar climates using an American Petroleum Institute (API) Certified for Gasoline Engines (Certification mark) oil of SM or SN quality, the normal oil change interval is 5,000 mi (8,000 km).

If the available API SM or SN oils are not available, then the oil change interval is 3,000 mi (4,800 km).

Engine Air Filter and Cabin Air Filter Replacement

The life of the engine air filter and cabin air filter is dependent on exposure to dusty and dirty conditions. Vehicles operated in these conditions require frequent inspection and replacement of the engine air filter and cabin air filter.

Customer Information

ROLLOVER WARNING



WARNING: Utility vehicles have a significantly higher rollover rate than other types of vehicles.



WARNING: Vehicles with a higher center of gravity (utility and four-wheel drive vehicles) handle differently than vehicles with a lower center of gravity (passenger cars). Avoid sharp turns, excessive speed and abrupt steering in these vehicles. Failure to drive cautiously increases the risk of losing control of your vehicle, vehicle rollover, personal injury and death.



WARNING: In a rollover crash, an unbelted person is significantly more likely to die than a person wearing a seatbelt.



WARNING: Do not become overconfident in the ability of four-wheel drive vehicles. Although a four-wheel drive vehicle may accelerate better than a two-wheel drive vehicle in low traction situations, it won't stop any faster than two-wheel drive vehicles. Always drive at a safe speed.

Utility vehicles and trucks handle differently than passenger cars in the various driving conditions that are encountered on streets, highways and off-road. Utility vehicles and trucks are not designed for cornering at speeds as high as passenger cars any more than low-slung sports cars are designed to perform satisfactorily under off-road conditions.

RADIO FREQUENCY CERTIFICATION LABELS

BLIND SPOT INFORMATION SYSTEM SENSORS

Argentina



RAMATEL

C-17954

Belarus



Brazil



Agência Nacional de Telecomunicações

01741-15-08699

Canada

Short Range Radar Sensor SRR3-B

IC ID: 4135A-SRR3B

Customer Information

This device contains licence-exempt transmitter(s)/receiver(s) that comply with Innovation, Science and Economic Development Canada's licence-exempt RSS(s). Operation is subject to the following two conditions:

1. This device may not cause interference.
2. This device must accept any interference, including interference that may cause undesired operation of the device.

Radiofrequency radiation exposure information:

This equipment complies with radiation exposure limits set forth for an uncontrolled environment. This equipment should be installed and operated with minimum distance of 8 in (20 cm) between the radiator and the body of any persons, user or bystander.

L'émetteur/récepteur exempt de licence contenu dans le présent appareil est conforme aux CNR d'Innovation, Sciences et Développement économique Canada applicables aux appareils radio exempts de licence. L'exploitation est autorisée aux deux conditions suivantes:

1. L'appareil ne doit pas produire de brouillage;
2. L'appareil doit accepter tout brouillage radioélectrique subi, même si le brouillage est susceptible d'en compromettre le fonctionnement.

Cet équipement est conforme aux limites d'exposition aux rayonnements établies pour un environnement non contrôlé. Cet équipement doit être installé et utilisé avec un minimum de 8 in (20 cm) de distance entre la source de rayonnement et votre corps.

Djibouti

AGREE PAR LE MCPT (REPUBLIQUE DE DJIBOUTI)
Numéro d'agrément : 240/MCPT/SG/16
Date d'agrément : 23/05/2016

European Union EU



Customer Information

Ghana

NCA PRODUCT IDENTIFIER: 3R8-8M-7DF-231

Mauritania

AGREE PAR L'ANE MAURITANIE
Numéro d'agrément : 0727/ARE/2018
Date d'agrément : 10/12/2019

Jamaica

This product has been Type Approved
by Jamaica: SMA - SRR3-B.

Malaysia



RALM/24A/0715/S(15-2272)

Mexico

IFETEL: RLVCSR15-0904

La operación de este equipo está sujeta a las siguientes
dos condiciones:

- (1) es posible que este equipo o dispositivo no cause
interferencia perjudicial y
- (2) este equipo o dispositivo debe aceptar cualquier
interferencia, incluyendo la que pueda causar
su operación no deseada.

Moldova



Customer Information

Pakistan



Serbia



Paraguay



Singapore

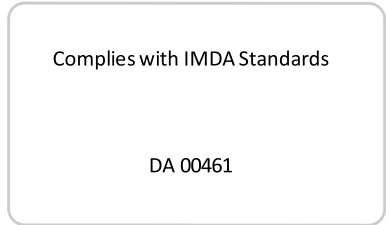

Russia



South Africa



Customer Information

South Korea



MSIP-CRM-8DC-SRR3B

Taiwan, China

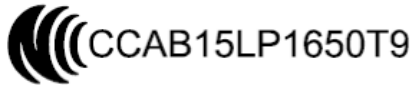

警語

經型式認證合格之低功率射頻電機，非經許可，公司、商號或使用者均不得擅自變更頻率、加大功率或變更原設計之特性及功能。

低功率射頻電機之使用不得影響飛航安全及干擾合法通信；經發現有干擾現象時，應立即停用，並改善至無干擾時方得繼續使用。

前項合法通信，指依電信法規定作業之無線電通信。低功率射頻電機須忍受合法通信或工業、科學及醫療用電波輻射性電機設備之干擾。

Customer Information

Ukraine



справжнім FIDC. Automotive Distance Control Systems GmbH заявляє, що тип радіообладнання SRR3 - В відповідає технічному регламенту радіообладнання ;

повний текст декларації про відповідність доступний на веб-сайті за такою адресою :

<http://continental.automotive-approvals.com/>

United Arab Emirates (U.A.E.)

TRA
REGISTERED No:
ER62934

DEALER No:
DA40068

United Kingdom



United States of America

FCC ID: OAYSRR3B

This device complies with Part 15 of the FCC Rules. Operation is subject to the following two conditions:

1. This device may not cause harmful interference, and
2. This device must accept any interference received, including interference that may cause undesired operation.

CAUTION TO USERS

Customer Information

Changes or modifications not expressly approved by the party responsible for compliance could void the user's authority to operate the equipment.

Vietnam

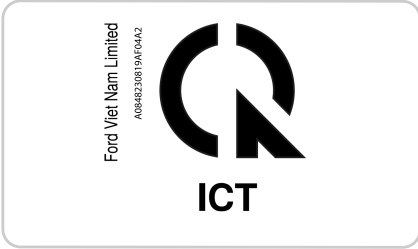

Zambia



BODY CONTROL MODULE

Argentina



Brazil



Ghana

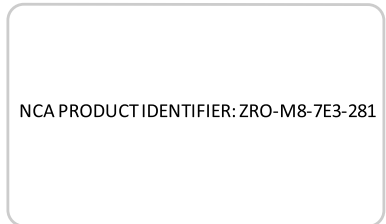

Customer Information

Jamaica

This product has been Type Approved by Jamaica: SMA - M3NA2C766336.

Paraguay



2019-01-I-000076

Moldova



Serbia



Morocco

AGREE PAR L'ANRT MAROC
Numéro d'agrément: MR 20148 ANRT 2019
Date d'agrément: 19/06/2019

Singapore

Complies with IMDA Standards

DA 00461

Customer Information

South Africa



Ukraine



United Arab Emirates (U.A.E.)

TRA REGISTERED No: ER68566/19

DEALER No: DA37380/15

United Kingdom



United States and Canada

WARNING: Changes or modifications not expressly approved by the party responsible for compliance could void the user's authority to operate the equipment. The term "IC:" before the radio certification number only signifies that Industry Canada technical specifications were met.

FCC ID: M3NA2C766336

IC: 7812A-A2C766336

This device complies with Part 15 of the FCC Rules and with Innovation, Science and Economic Development Canada's licence-exempt RSS(s). Operation is subject to the following two conditions:

1. This device may not cause harmful interference, and
2. This device must accept any interference received, including interference that may cause undesired operation.

Vietnam

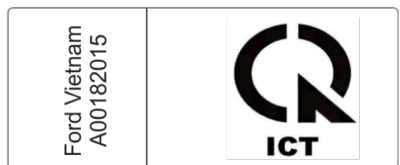

Customer Information

Zambia



Djibouti

AGREE PAR LE MCPT (REPUBLIQUE DE DJIBOUTI)
Numéro d'agrément : 594/dpt/2017
Date d'agrément : 09/04/2017

Ghana

CRUISE CONTROL MODULE

Argentina

NCA PRODUCT IDENTIFIER: OR2-9H-7E1-x4D



Indonesia

SERTIFIKAT NOMOR : 53104/SDPPI/2017
PLG ID: 4927



Brazil



Jamaica

This product has been Type Approved
by Jamaica: SMA - L2C0065TR.

Customer Information

Malaysia



RALM/61A/0318/S(18-0852)

Mauritania

AGREE PAR L'ANE MAURITANIE
Numéro d'agrément: 0409/ARE/2017
Date d'agrément: 12/04/2017

Moldova



Morocco

AGREE PAR L'ANRT MAROC
Numéro d'agrément: MR 13639 ARNT 2017
Date d'agrément: 28/03/2017

Pakistan



Paraguay



Customer Information

Serbia



South Korea



R-CMM-DLH-L2C0065TR

Syria

Singapore

Complies with IMDA Standards
DA105753

SyTRA
REGISTERED No:
FR00085-17

Taiwan, China

South Africa

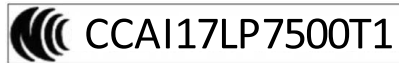

Customer Information

Ukraine



This device complies with Part 15 of the FCC Rules and with Innovation, Science and Economic Development Canada's licence-exempt RSS(s). Operation is subject to the following two conditions:

1. This device may not cause harmful interference, and
2. This device must accept any interference received, including interference that may cause undesired operation.

Zambia

United Arab Emirates



United States and Canada

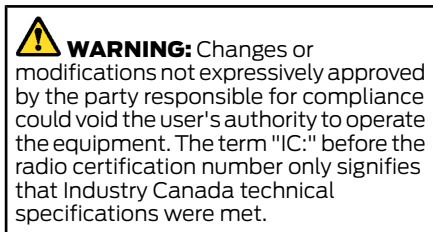

FCC ID: L2C0065TR
IC: 3432A-0065TR

GARAGE DOOR OPENER

United States and Canada

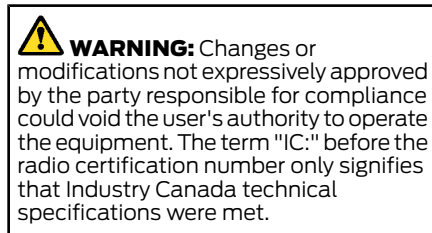

FCC ID: NZLSAHL5E
IC: 4112A-SAHL5E

Customer Information

This device complies with Part 15 of the FCC Rules and with Innovation, Science and Economic Development Canada's licence-exempt RSS(s). Operation is subject to the following two conditions:

1. This device may not cause harmful interference, and
2. This device must accept any interference received, including interference that may cause undesired operation.

KEYS AND REMOTE CONTROLS

Argentina

 **COMISIÓN NACIONAL
DE COMUNICACIONES**

CNC ID: H-22290

CNC: H-16366

 **COMISIÓN NACIONAL
DE COMUNICACIONES** **COMISIÓN NACIONAL
DE COMUNICACIONES**

CNC ID: H-24101

 **COMISIÓN NACIONAL
DE COMUNICACIONES**

CNC ID: H-16355

 **COMISIÓN NACIONAL
DE COMUNICACIONES**

CNC ID: H-13305

Customer Information

Brazil



AGREE PAR LE MCPT (REPUBLIQUE DE DJIBOUTI)
Numéro d'agrément : 289/MCPT/SC/116
Date d'agrément : 02/07/2016

Ghana



NCA APPROVED: 2R9-8M-7E0-x94

NCA APPROVED: 2R9-1H-7E0-01A



Jamaica

This product has been Type Approved
by Jamaica: SMA – A2C97102000

Djibouti

AGREE PAR LE MCPT (REPUBLIQUE DE DJIBOUTI)
Numéro d'agrément : 287/MCPT/SC/16
Date d'agrément : 02/07/2016

**This product has been Type Approved
by Jamaica: SMA – A2C93142100**

Customer Information

F17000176

Mauritania

This product has been Type Approved by Jamaica: SMA – M3N-A2C931426

AGREE PAR L'ANE MAURITANIE
Numéro d'agrément : 0324/ARE/2016
Date d'agrément : 07/03/2016

This product has been Type Approved by Jamaica: SMA – M3N-A2C931423

AGREE PAR L'ANE MAURITANIE
Numéro d'agrément : 0323/ARE/2016
Date d'agrément : 07/03/2016

This product has been Type Approved by
Jamaica: SMA – N5F-A08TAA.

Moldova



Malaysia



Customer Information

Morocco

AGREE PAR L'ANRT MAROC
Numéro d'agrément : MR 12432 ANRT 2016
Date d'agrément : 31/08/2016



Paraguay

AGREE PAR L'ANRT MAROC
Numéro d'agrément : MR 12433 ANRT 2016
Date d'agrément : 31/08/2016



Pakistan

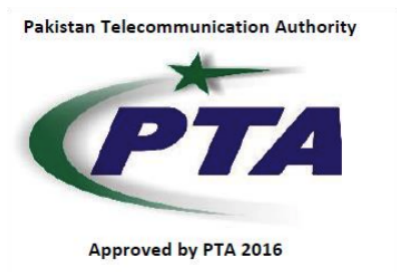

NR: 2016-9-I-000222
NR: 2016-9-I-000220
NR: 2016-9-I-000223
NR: 2017-10-I-0334
NR: 2018-07-I-000317

Customer Information

Serbia



W011 16



Singapore

Complies with IMDA Standards

DA 00461

South Korea



MSIP-CRM-TAL-A2C97102000

South Africa



Taiwan, China

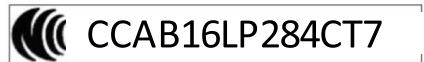

Customer Information

Ukraine

 CCAB16LP284DT9



United Arab Emirates (U.A.E.)

 CCAB14LP5630T2

TRA
REGISTERED No: ER47690/16
DEALER No: DA37380/15

 CCAB14LP563AT4

TRA
REGISTERED No:
ER46754/16

DEALER No:
DA37380/15

Customer Information

TRA
REGISTERED NO: ER49357/16
DEALER NO: DA37380/15

This device complies with Part 15 of the FCC Rules and with Innovation, Science and Economic Development Canada's licence-exempt RSS(s). Operation is subject to the following two conditions:

1. This device may not cause harmful interference, and
2. This device must accept any interference received, including interference that may cause undesired operation.

Canada and United States of America



WARNING: Changes or modifications not expressly approved by the party responsible for compliance could void the user's authority to operate the equipment. The term "IC:" before the radio certification number only signifies that Industry Canada technical specifications were met.

FCC ID: M3N-A2C931426
FCC ID: M3N-A2C931423
FCC ID: CWTWBIU0009
FCC ID: N5F-A08TAA
IC: 7812A-A2C931426
IC: 7812A-A2C913423
IC: 1788A-FWBUIU0009
IC: 3248A-A08TAA

Vietnam

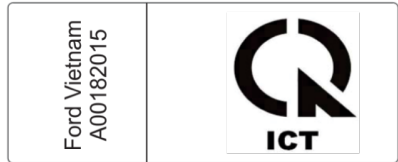

Zambia



Customer Information



PASSIVE ANTI-THEFT SYSTEM

Argentina



Brazil



0106-14-03199

Este equipamento opera em caráter secundário, isto é, não tem direito a proteção contra interferência prejudicial, mesmo de estações do mesmo tipo, e não pode causar interferência a sistemas operando em caráter primário.

Canada and United States of America

WARNING: Changes or modifications not expressly approved by the party responsible for compliance could void the user's authority to operate the equipment. The term "IC:" before the radio certification number only signifies that Industry Canada technical specifications were met.

FCC ID: OUC11545917

IC: OUC11545917

This device complies with Part 15 of the FCC Rules and with Innovation, Science and Economic Development Canada's licence-exempt RSS(s). Operation is subject to the following two conditions:

1. This device may not cause harmful interference, and
2. This device must accept any interference received, including interference that may cause undesired operation.

Djibouti

AGREE PAR LE MCPT (REPUBLIQUE DE DJIBOUTI)
Numéro d'agrément: 243/MCPT/SC/16
Date d'agrément: 23/05/16

Customer Information

Ghana

NCA APPROVED: NCA/TA/16/22

Malaysia



CIDF18000209

Indonesia

SERTIFIKAT NOMOR : 44714/SDPPI/2016
PLG ID: 4941

Mauritania

AGREE PAR L'ANE MAURITANIE
Numéro d'agrément: 0231/ARE/2014
Date d'agrément: 14/11/2014

Jamaica

This product has been Type Approved by Jamaica: SMA- OUC11545917

Moldova



Customer Information

Morocco

AGREE PAR L'ANRT MAROC
Numéro d'agrément: MR 8922 ANRT 2014
Date d'agrément: 04/02/2014

Serbia

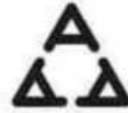

И011 16

Pakistan

Pakistan Telecommunication Authority



Approved by PTA 2015

Singapore

Complies with IMDA Standards

DA 00461

Paraguay

NR: 2017-09-10000292



South Africa

TA-2013/1617

APPROVED



Customer Information

South Korea



MSIP-RRM-OAC-OUC11541917

Syria

SyTRA
REGISTERED No:
1510/4NK

Ukraine



United Arab Emirates (U.A.E.)

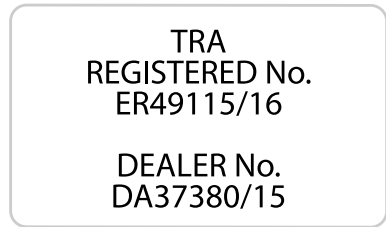

Taiwan

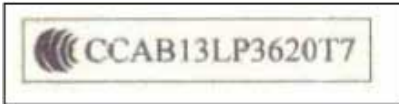

Vietnam

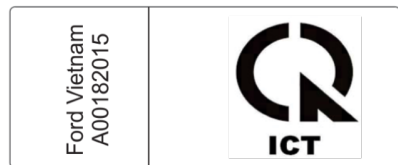

Customer Information

RADIO TRANSCEIVER MODULE

Argentina

NCA APPROVED: SRO-1M-7E4-114



Mauritania



Brazil



Djibouti

AGREE PAR LE MCPT (REPUBLIQUE DE DJIBOUTI)
Numéros d'agrément : 033/DDTIC/2020
Date d'agrément : 07/06/2020

AGREE PAR LE MCPT (REPUBLIQUE DE DJIBOUTI)
Numéros d'agrément : 034/DDTIC/2020
Date d'agrément : 07/06/2020

Moldova



Ghana

NCA APPROVED: SRO-1M-7E4-108

Customer Information

Morocco

AGREE PAR L'ANE MAROC
Numéro d'agrément : MR 24102 ANRT 2020
Date d'agrément : 18/05/2020

South Africa



Pakistan



Taiwan, China

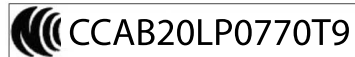

Serbia



Ukraine



Customer Information

United Arab Emirates (U.A.E.)

TRA
REGISTERED No:
ER81341/20

DEALER No:
DA88113/20

This device complies with Part 15 of the FCC Rules and with Innovation, Science and Economic Development Canada's licence-exempt RSS(s). Operation is subject to the following two conditions:

1. This device may not cause harmful interference, and
2. This device must accept any interference received, including interference that may cause undesired operation.

Zambia

TRA
REGISTERED No:
ER81342/20

DEALER No:
DA88113/20



United States and Canada



WARNING: Changes or modifications not expressly approved by the party responsible for compliance could void the user's authority to operate the equipment. The term "IC:" before the radio certification number only signifies that Industry Canada technical specifications were met.

FCC ID: L2C0082R

FCC ID: L2C0083TR

IC: 342A-0083TR

SYNC

Argentina

CNC COMISIÓN NACIONAL
DE COMUNICACIONES

CNC ID: C-20317

Customer Information

Brazil



European Union EU

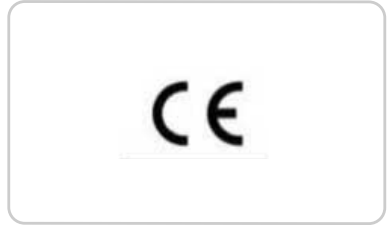

China

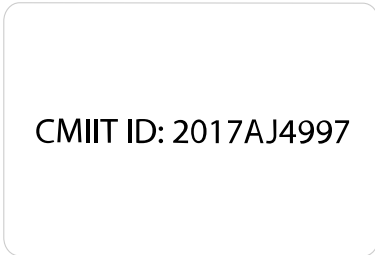

Ghana

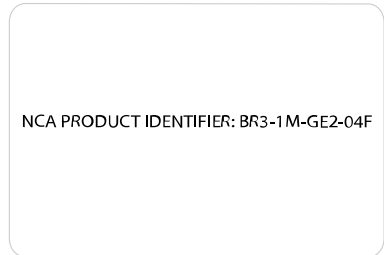

Djibouti



Jamaica

This product has been Type Approved
by Jamaica: SMA - FG-185-SG32-MH.

Customer Information

Malaysia



RBAB/57H/0318/S(18-0624)

Mauritania

AGREE PAR L'ANEMAURITANIE
Numéro d'agrément: 0442/ARE/2017
Date d'agrément: 21/11/2017

Morocco

AGREE PAR L'ANRT MAROC
Numéro d'agrément: MR 15193 ANRT 2017
Date d'agrément: 22/11/2017

Pakistan



Date of Issuance: 11/30/2017

Moldova



Paraguay



NR: 2017-12-I-0000413

Customer Information

Serbia



South Korea



MSIP-CMM-pAs-FA-170-BCAR-HS

Singapore

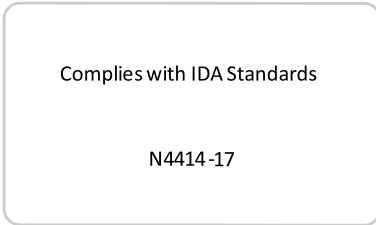

Taiwan



South Africa



Ukraine



Customer Information

United Arab Emirates (U.A.E.)



United States and Canada

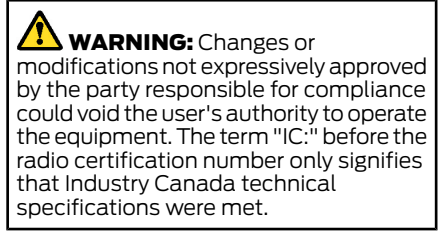

SYNC Version	FCC Identification Number	IC Identification Number
3.0	ACJ-SYNCG3-L	216B-SYNCG3-L
3.1	ACJ-FA-170-BCARHS	216B-FA170BCARHS
3.2	ACJ-FG-185-SG32MH	216B-FG185SG32MH

This device complies with Part 15 of the FCC Rules and with Innovation, Science and Economic Development Canada's licence-exempt RSS(s). Operation is subject to the following two conditions:

1. This device may not cause harmful interference, and
2. This device must accept any interference received, including interference that may cause undesired operation.

Vietnam



Customer Information

Zambia



TELEMATICS CONTROL UNIT

Brazil



United Arab Emirates (U.A.E.)

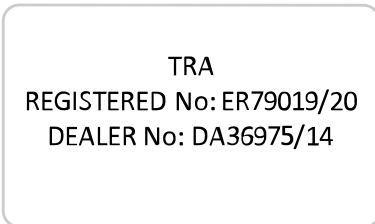

United States and Canada

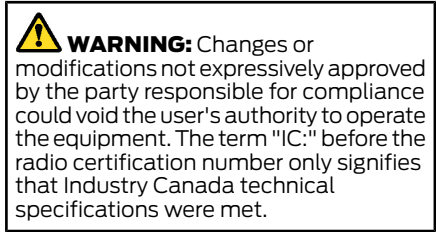

FCC ID: LHJ-FB40ND1

IC: 2807E-FB40ND1

This device complies with Part 15 of the FCC Rules and with Innovation, Science and Economic Development Canada's licence-exempt RSS(s). Operation is subject to the following two conditions:

1. This device may not cause harmful interference, and
2. This device must accept any interference received, including interference that may cause undesired operation.

TIRE PRESSURE MONITORING SYSTEM SENSORS - VEHICLES WITH: 315 MHZ SENSORS

Brazil



Customer Information

Mexico

IFT: RCPCSCAG18-1886
"La operación de este equipo está sujeta a las siguientes dos condiciones:
(1) es posible que este equipo o dispositivo no cause interferencia perjudicial y
(2) este equipo o dispositivo debe aceptar cualquier interferencia, incluyendo la que pueda causar su operación no deseada."

Taiwan



Nigeria

Connection and use of this communications equipment is permitted by the Nigerian Communications Commission

United Kingdom



Singapore

Complies with IMDA Standards

DA 105282

United States and Canada

 **WARNING:** Changes or modifications not expressly approved by the party responsible for compliance could void the user's authority to operate the equipment. The term "IC:" before the radio certification number only signifies that Industry Canada technical specifications were met.

FCC ID: MRXAG2SM3

IC: 2546A-AG2SM3

Customer Information

This device complies with Part 15 of the FCC Rules and with Innovation, Science and Economic Development Canada's licence-exempt RSS(s). Operation is subject to the following two conditions:

1. This device may not cause harmful interference, and
2. This device must accept any interference received, including interference that may cause undesired operation.

TIRE PRESSURE MONITORING SYSTEM SENSORS - VEHICLES WITH: 433 MHZ SENSORS

Argentina



Brazil



Democratic Republic of Congo

Agréé par l'ARPTC

N° d'homologation: HIR -0081/6/2018

Date d'homologation: 18/6/2018

Djibouti

AGREE PAR LE MCPT (REPUBLIQUE DE DJIBOUTI)

Numéro d'agrément:

045/DDTIC/2018

Date d'agrément:

06/05/18

European Union EU

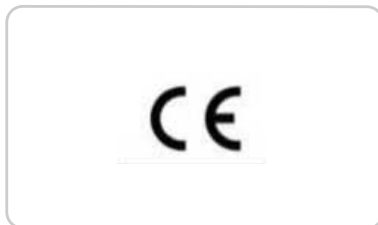

Customer Information

The RED 2014/53/EU (replacing R&TTE Directive 1999/5/EC on 13 June 2016) explicitly states that instructions for intentional radiators include reference to "(a) frequency band(s) in which the radio equipment operates; and (b) maximum radio-frequency power transmitted in the frequency band(s) in which the radio equipment operates," in addition to carrying over the general operational instruction and Declaration of Conformity inclusion requirements from the R&TTE Directive.

Hereby, Schrader Electronics Ltd. declares that the radio equipment type AG2SM4 is in compliance with Directive 2014/53/EU. The full text of the EU declaration of conformity is available at the following internet address:

http://www.tpmseuroshop.com/documents/declaration_conformities

f=433.92MHz

P<10mW (e.i.r.p)

Schrader Electronics Ltd. 11 Technology Park, Belfast Road, Antrim BT41 IQS, Northern Ireland United Kingdom.

Ghana

NCA APPROVED: BR3-1M-GE2-X74

Israel

1. מספר התקן :
 SCHRADER ELECTRONICS : ש"מ
 AG2SM4 : ש"מ
 מס' ת.ק :
 מס' ת.ק :
 מס' ת.ק :
 מס' ת.ק :
 מס' ת.ק :

מס' ת.ק	מחיר (ש"ח)	מחיר (דולר)	מחיר (אירו)	מחיר (דולר)	מחיר (אירו)
ASK	320.00	0.000010	434.7900	433.0500	433.0500

2. מס' ת.ק : 2023-03-22

Customer Information

Mauritania

AGREE PAR L'ANEMAURITANIE
Numéro d'agrément: 0489/ARE/2018
Date d'agrément: 04/25/2018

Morocco

AGREE PAR L'ANRT MAROC
Numéro d'agrément: MR 16506 ANRT 2018
Date d'agrément: 09/05/2018

Mexico

IFT: RLVSCAG18-1012
*La operación de este equipo está sujeta a las siguientes dos condiciones:
(1) es posible que este
equipo o dispositivo no cause interferencia perjudicial y
(2) este equipo o dispositivo debe aceptar
cualquier interferencia, incluyendo la que pueda causar
su operación no deseada.*

Nigeria

Connection and use of this
communications
equipment is permitted by the Nigerian
Communications Commission

Moldova



Oman

OMAN TRA
R/5505/18
D172249

Customer Information

Pakistan



Serbia

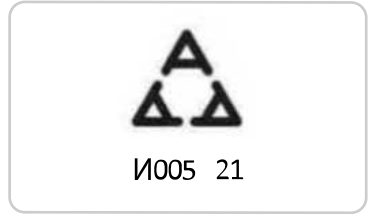

Paraguay



Sierra Leone



NR: 2018-06-I-000224

**Customs Union (CU) - Belarus,
Kazakhstan and Russia**



TAN: 2018-002-0025

Singapore

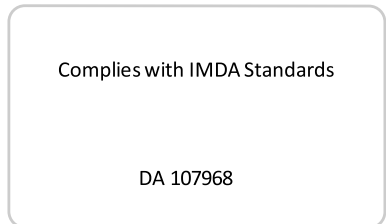

Customer Information

South Africa



Ukraine



South Korea



R-CRM-SRD-AG2SM4

Taiwan

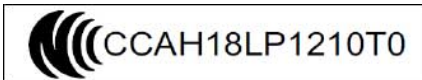

United Arab Emirates (U.A.E.)

TRA REGISTERED No:

ER97590/21

DEALER No:

DA37380/15

United Kingdom



Customer Information

United States and Canada



WARNING: Changes or modifications not expressly approved by the party responsible for compliance could void the user's authority to operate the equipment. The term "IC:" before the radio certification number only signifies that Industry Canada technical specifications were met.

FCC ID: MRXAG2SM4

IC: 2546A- AG2SM4

This device complies with Part 15 of the FCC Rules and with Innovation, Science and Economic Development Canada's licence-exempt RSS(s). Operation is subject to the following two conditions:

1. This device may not cause harmful interference, and
2. This device must accept any interference received, including interference that may cause undesired operation.

Vietnam

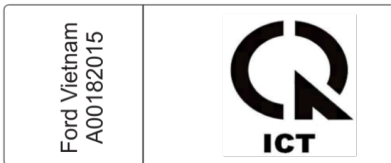

C0170230620AF04A2

Zambia



WIRELESS ACCESSORY CHARGING MODULE

Argentina



Customer Information

Brazil



European Union EU

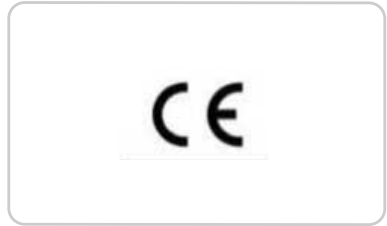

Ghana

NCA APPROVED: 1R3-1M-7E1-174

Djibouti



NCA APPROVED: 7ES-7M-110-RDR

Jamaica

AGREE PAR LE MCPT (REPUBLIQUE DE DJIBOUTI)
Numéro d'agrément : 133/DDTIC/2021
Date d'agrément : 07/09/2021

This product has been Type Approved
by Jamaica: SMA - WACM.

Customer Information

Mauritania

This product has been Type Approved By Jamaica:
SMA – WACM3

AGREE PAR L'ANE MAURITANIE
Numéro d'agrément : 0474/ARE/2018
Date d'agrément : 05/03/2018

Jordan

Type Approval No: TRC/LPD/2017/418
Equipment Type: Low Power Device (LPD)

Malaysia



SQASI/TA/19/4129
SQASI/TA/21/3832

AGREE PAR L'ANE MAURITANIE
Numéro d'agrément : 0964/ARE/2021
Date d'agrément : 7/12/2021

Moldova



Customer Information

Morocco

AGREE PAR L'ANRT MAROC
Numéro d'agrément : MR 15474 ANRT 2017
Date d'agrément : 25/12/2017

Russia



Serbia



U011 18

AGREE PAR L'ANRT MAROC
Numéro d'agrément : MR 00029420 ANRT 2021
Date d'agrément : 11/07/2021

Paraguay



U005 21

2017-10-I-0000333

2021-08-I-0489

Customer Information

Singapore

Complies with IMDA Standards

DA 00461

South Korea



R-RMM-DLH-WACM

South Africa



Taiwan

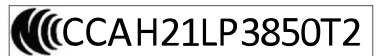
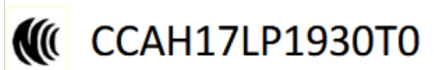

Customer Information

Ukraine



TRA
REGISTERED No:
ER98639/21

DEALER No:
DA37380/15

United Arab Emirates (U.A.E.)

TRA
REGISTERED No:
ER57347/17

DEALER No:
DA37380/15

United Kingdom



United States and Canada

 **WARNING:** Changes or modifications not expressly approved by the party responsible for compliance could void the user's authority to operate the equipment. The term "IC:" before the radio certification number only signifies that Industry Canada technical specifications were met.

TRA
REGISTERED No:
ER98640/21

DEALER No:
DA37380/15

FCC ID: L2C0066T
FCC ID: L2C0084T
FCC ID: L2C0074TR
FCC ID: L2C0084TR
IC ID: 3432A-0074TR

Customer Information

This device complies with Part 15 of the FCC Rules and with Innovation, Science and Economic Development Canada's licence-exempt RSS(s). Operation is subject to the following two conditions:

1. This device may not cause harmful interference, and
2. This device must accept any interference received, including interference that may cause undesired operation.



Vietnam

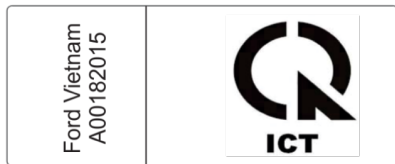

Zambia



WARRANTY INFORMATION

The following warranties may apply to your vehicle:

- New vehicle limited warranties.
- Emissions warranties, if applicable. (Note: Fully-electric vehicles are not eligible for emissions warranties.)
- Other warranties, if applicable.

Detailed warranty information specific to your vehicle can be found in the Warranty Guide at www.owner.ford.com.

The following California Warranty Statement, required by California regulations, applies to vehicles certified to California emissions standards and registered in a state that requires California emissions warranty. If applicable, additional California Emissions Warranties can be found in the Warranty Guide at www.owner.ford.com.

CALIFORNIA EMISSION CONTROL WARRANTY STATEMENT

YOUR WARRANTY RIGHTS AND OBLIGATIONS

The California Air Resources Board and Ford Motor Company are pleased to explain the emission control system warranty on your (year) vehicle. In California, new motor vehicles must be designated, built and equipped to meet

Customer Information

the State's stringent anti-smog standards. Ford Motor Company must warrant the emission control system on your vehicle for the periods of time listed below provided there has been no abuse, neglect or improper maintenance of your vehicle.

Your emission control system may include parts such as the carburetor or fuel-injection system, the ignition system, catalytic converter and engine computer. Also included may be hoses, belts, connectors and other emission-related assemblies. Where a warrantable condition exists, Ford Motor Company will repair your vehicle at no cost to you including diagnosis, parts and labor.

MANUFACTURER'S WARRANTY COVERAGE:

(For 1990 and subsequent model passenger cars, light-duty trucks, and medium-duty vehicles.)

- For 3 years or 50,000 miles (whichever occurs first);

1) If your vehicle fails a Smog Check inspection, all necessary repairs and adjustments will be made by Ford Motor Company to ensure that your emission control system **PERFORMANCE WARRANTY**.

2) If any emission-related part on your vehicle is defective, the part will be repaired or replaced by Ford Motor Company. This is your short-term emission control system **DEFECTS WARRANTY**.

- For 7 years or 70,000 miles (whichever occurs first);

1) If an emission-related part listed in this warranty booklet specially noted with coverage for 7 years or 70,000 miles is defective, the part will be repaired or replaced by Ford Motor Company. This is your long-term emission control system **DEFECTS WARRANTY**.

OWNER'S WARRANTY RESPONSIBILITIES:

- As the vehicle owner, you are responsible for the performance of the required maintenance listed in your owner's manual. Ford Motor Company recommends that you retain all receipts covering maintenance on your vehicle, but Ford Motor Company cannot deny warranty solely for the lack of receipts or for your failure to ensure the performance of all scheduled maintenance.

- You are responsible for presenting your vehicle to a Ford or Lincoln dealer as soon as a problem exists. The warranty repairs should be completed in a reasonable amount of time, not to exceed 30 days.

- As the vehicle owner, you should also be aware that Ford Motor Company may deny you warranty coverage if your vehicle or a part has failed due to abuse, neglect, improper maintenance or unapproved modifications.

If you have any questions regarding your warranty rights and responsibilities, you should contact Ford Customer Service at 1-800-392-3673 or the California Air Resource Board at 9528 Telstar Avenue, El Monte, CA 91731.

Appendices

ELECTROMAGNETIC COMPATIBILITY



WARNING: Do not place objects or mount equipment on or near the airbag cover, on the side of the front or rear seatbacks, or in areas that may come into contact with a deploying airbag. Failure to follow these instructions may increase the risk of personal injury in the event of a crash.



WARNING: Do not fasten antenna cables to vehicle wiring, fuel pipes and brake pipes.



WARNING: Keep antenna and power cables at least 4 in (10 cm) from any electronic modules and airbags.

Note: We test and certify your vehicle to meet electromagnetic compatibility legislation. It is your responsibility to make sure that any equipment an authorized dealer installs on your vehicle complies with applicable local legislation and other requirements. Installation of some aftermarket electronic devices could degrade the performance of vehicle functions, which use radio frequency signals such as broadcast radio receiver, tire pressure monitoring system, push button start, **Bluetooth®** connectivity or satellite navigation.

Note: Any radio frequency transmitter equipment in your vehicle (such as cellular telephones and amateur radio transmitters) must keep to the parameters in the following illustrations and table. We do not provide any other special provisions or conditions for installations or use.

Car/SUV

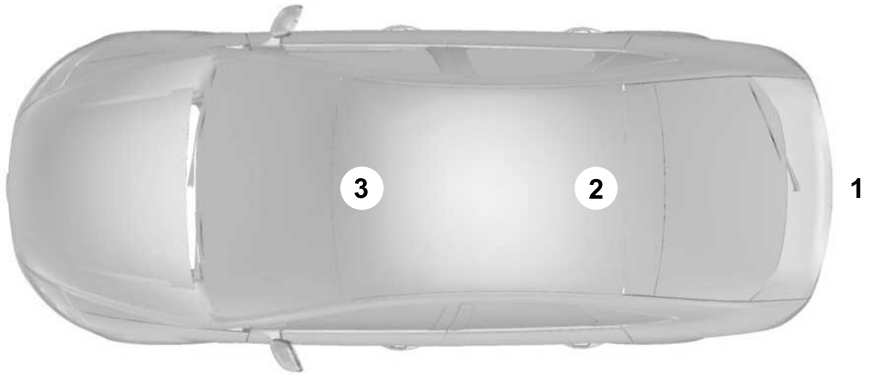

Appendices

Van



Truck

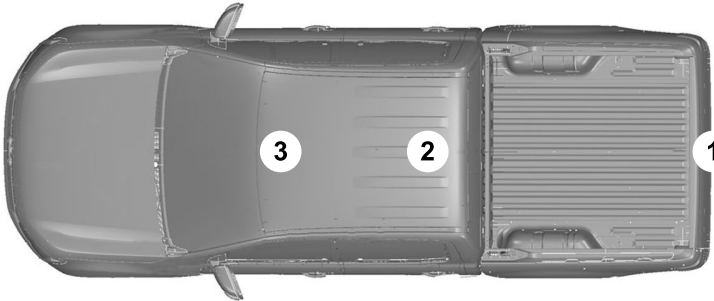

Appendices

Frequency Band MHz	Maximum Output Power Watt (Peak RMS)	Antenna Positions
1-30	50	1
50-54	50	2, 3
68-87	50	2, 3
142-176	50	2, 3
380-512	50	2, 3
806-870	10	2, 3

Appendices

END USER LICENSE AGREEMENT

VEHICLE SOFTWARE END USER LICENSE AGREEMENT (EULA) (if

Equipped)

- You ("You" or "Your" as applicable) have acquired a vehicle having several devices, including SYNC ® and various control modules, ("DEVICES") that include software licensed or owned by Ford Motor Company and its affiliates ("FORD MOTOR COMPANY"). Those software products of FORD MOTOR COMPANY origin, as well as associated media, printed materials, and "online" or electronic documentation ("SOFTWARE") are protected by international intellectual property laws and treaties. The SOFTWARE is licensed, not sold. All rights reserved.
- The SOFTWARE may interface with and/or communicate with, or may be later upgraded to interface with and/or communicate with additional software and/or systems provided by FORD MOTOR COMPANY.

IF YOU DO NOT AGREE TO THIS END USER LICENSE AGREEMENT ("EULA") DO NOT USE THE DEVICES OR COPY THE SOFTWARE. ANY USE OF THE SOFTWARE, INCLUDING BUT NOT LIMITED TO USE ON THE DEVICES, WILL CONSTITUTE YOUR AGREEMENT TO THIS EULA (OR RATIFICATION OF ANY PREVIOUS CONSENT).

GRANT OF SOFTWARE LICENSE: This EULA grants you the following license:

- You may use the SOFTWARE as installed on the DEVICES and as otherwise interfacing with systems and/or services provide by or through FORD MOTOR COMPANY or its third party software and service providers.

Description of Other Rights and Limitations

- **Speech Recognition:** If the SOFTWARE includes speech recognition component(s), you should understand that speech recognition is an inherently statistical process and that recognition errors are inherent in the process. Neither FORD MOTOR COMPANY nor its suppliers shall be liable for any damages arising out of errors in the speech recognition process. It is your responsibility to monitor any speech recognition functions included in the system.
- **Limitations on Reverse Engineering, Decompilation and Disassembly:** You may not reverse engineer, decompile, translate, disassemble or attempt to discover any source code or underlying ideas or algorithms of the SOFTWARE nor permit others to reverse engineer, decompile or disassemble the SOFTWARE, except and only to the extent that such activity is expressly permitted by applicable law notwithstanding this limitation or to the extent as may be permitted by the licensing terms governing use of any open source components included with the SOFTWARE.
- **Limitations on Distributing, Copying, Modifying and Creating Derivative Works:** You may not distribute, copy, make modifications to or create derivative works based on the SOFTWARE, except and only to the extent that such activity is expressly permitted by applicable law notwithstanding this limitation or to the extent as may be permitted by the licensing terms governing use of any open source components included with the SOFTWARE.

Appendices

- **Single EULA:** The end user documentation for the DEVICES and related systems and services may contain multiple EULAs, such as multiple translations and/or multiple media versions (e.g., in the user documentation and in the software). Even if you receive multiple EULAs, you are licensed to use only one (1) copy of the SOFTWARE.
- **SOFTWARE Transfer:** You may permanently transfer your rights under this EULA only as part of a sale or transfer of the DEVICES, provided you retain no copies, you transfer all of the SOFTWARE (including all component parts, the media and printed materials, any upgrades, and, if applicable, the Certificate(s) of Authenticity), and the recipient agrees to the terms of this EULA. If the SOFTWARE is an upgrade, any transfer must include all prior versions of the SOFTWARE.
- **Termination:** Without prejudice to any other rights, FORD MOTOR COMPANY may terminate this EULA if you fail to comply with the terms and conditions of this EULA.
- **Internet-Based Services Components:** The SOFTWARE may contain components that enable and facilitate the use of certain Internet-based services. You acknowledge and agree that FORD MOTOR COMPANY, third party software and service suppliers, its affiliates and/or its designated agent may automatically check the version of the SOFTWARE and/or its components that you are utilizing and may provide upgrades or supplements to the SOFTWARE that may be automatically downloaded to your DEVICES.
- **Additional Software/Services:** The SOFTWARE may permit FORD MOTOR COMPANY, third party software and service suppliers, its affiliates and/or its designated agent to provide or make available to you SOFTWARE updates, supplements, add-on components, or Internet-based services components of the SOFTWARE after the date you obtain your initial copy of the SOFTWARE ("Supplemental Components".) SOFTWARE updates may cause you to incur additional charges from your wireless service provider. If FORD MOTOR COMPANY or third party software and services suppliers provide or make available to you Supplemental Components and no other EULA terms are provided along with the Supplemental Components, then the terms of this EULA shall apply. FORD MOTOR COMPANY, its affiliates and/or its designated agent reserve the right to discontinue without liability any Internet-based services provided to you or made available to you through the use of the SOFTWARE.

Appendices

- **Links to Third Party Sites:** The SOFTWARE may provide you with the ability to link to third party sites. The third party sites are not under the control of FORD MOTOR COMPANY, its affiliates and/or its designated agent. Neither FORD MOTOR COMPANY nor its affiliates nor its designated agent are responsible for (i) the contents of any third party sites, any links contained in third party sites, or any changes or updates to third party sites, or (ii) webcasting or any other form of transmission received from any third party sites. If the SOFTWARE provides links to third party sites, those links are provided to you only as a convenience, and the inclusion of any link does not imply an endorsement of the third party site by FORD MOTOR COMPANY, its affiliates and/or its designated agent.
- **Obligation to Drive Responsibly:** You recognize your obligation to drive responsibly and keep attention on the road. You will read and abide with the DEVICES operating instructions particularly as they pertain to safety and you agree to assume any risk associated with the use of the DEVICES.

UPGRADES AND RECOVERY MEDIA:

If the SOFTWARE is provided by FORD MOTOR COMPANY separate from the DEVICES on media such as a ROM chip, CD ROM disk(s) or via web download or other means, and is labeled "For Upgrade Purposes Only" or "For Recovery Purposes Only" you may install one (1) copy of such SOFTWARE onto the DEVICES as a replacement copy for the existing SOFTWARE, and use it in accordance with this EULA, including any additional EULA terms accompanying the upgrade SOFTWARE.

INTELLECTUAL PROPERTY RIGHTS:

All title and intellectual property rights in and to the SOFTWARE (including but not limited to any images, photographs, animations, video, audio, music, text and "applets" incorporated into the SOFTWARE), the accompanying printed materials, and any copies of the SOFTWARE, are owned by FORD MOTOR COMPANY, or its affiliates or suppliers. The SOFTWARE is licensed, not sold. You may not copy the printed materials accompanying the SOFTWARE. All title and intellectual property rights in and to the content which may be accessed through use of the SOFTWARE is the property of the respective content owner and may be protected by applicable copyright or other intellectual property laws and treaties. This EULA grants you no rights to use such content outside its intended use. All rights not specifically granted under this EULA are reserved by FORD MOTOR COMPANY, its affiliates, and third party software and service providers and suppliers. Use of any on-line services which may be accessed through the SOFTWARE may be governed by the respective terms of use relating to such services. If this SOFTWARE contains documentation that is provided only in electronic form, you may print one copy of such electronic documentation.

EXPORT RESTRICTIONS: You acknowledge that the SOFTWARE is subject to U.S. and European Union export jurisdiction. You agree to comply with all applicable international and national laws that apply to the SOFTWARE, including the U.S. Export Administration Regulations, as well as end-user, end-use and destination restrictions issued by U.S. and other governments.

Appendices

TRADEMARKS: This EULA does not grant you any rights in connection with any trademarks or service marks of FORD MOTOR COMPANY, its affiliates, and third party software and service providers.

The **Bluetooth®** word mark and logos are registered trademarks owned by **Bluetooth SIG, Inc.** and any use of such marks by Ford Motor Company is under license. Other trademarks and trade names are those of their respective owners.

PRODUCT SUPPORT: Please refer to FORD MOTOR COMPANY instructions provided in the documentation for the DEVICES product support, such as the vehicle owner guide.

Should you have any questions concerning this EULA, or if you desire to contact FORD MOTOR COMPANY for any other reason, please refer to the address provided in the documentation for the DEVICES.

No Liability for Certain Damages: EXCEPT AS PROHIBITED BY LAW, FORD MOTOR COMPANY, ANY THIRD PARTY SOFTWARE OR SERVICES SUPPLIERS, AND THEIR AFFILIATES SHALL HAVE NO LIABILITY FOR ANY INDIRECT, SPECIAL, CONSEQUENTIAL OR INCIDENTAL DAMAGES ARISING FROM OR IN CONNECTION WITH THE USE OR PERFORMANCE OF THE SOFTWARE. THIS LIMITATION SHALL APPLY EVEN IF ANY REMEDY FAILS OF ITS ESSENTIAL PURPOSE. THERE ARE NO WARRANTIES OTHER THAN THOSE THAT MAY BE EXPRESSLY PROVIDED FOR YOUR NEW VEHICLE.

SYNC® Automotive Important Safety Information Read and follow instructions:

- Before using your SYNC® system, read and follow all instructions and safety information provided in this end user manual ("Owner Guide".) Not following precautions found in the Owner Guide can lead to an accident or other serious injuries.

General Operation

- **Voice Command Control:** Certain functions within the SYNC® system may be accomplished using voice commands. Using voice commands while driving helps you to operate the system without removing your hands from the wheel or eyes from the road.
- **Prolonged Views of Screen:** Do not access any function requiring a prolonged view of the screen while you are driving. Pull over in a safe and legal manner before attempting to access a function of the system requiring prolonged attention.
- **Volume Setting:** Do not raise the volume excessively. Keep the volume at a level where you can still hear outside traffic and emergency signals while driving. Driving while unable to hear these sounds could cause an accident.
- **Navigation Features:** Any navigation features included in the system are intended to provide turn by turn instructions to get you to a desired destination. Please make certain all persons using this system carefully read and follow instructions and safety information fully.

Appendices

- **Distraction Hazard:** Any navigation features may require manual (non-verbal) setup. Attempting to perform such set-up or insert data while driving can distract your attention and could cause an accident or other serious injury. Stop the vehicle in a safe and legal manner before attempting these operations.
- **Let Your Judgment Prevail:** Any navigation features are provided only as an aid. Make your driving decisions based on your observations of local conditions and existing traffic regulations. Any such feature is not a substitute for your personal judgment. Any route suggestions made by this system should never replace any local traffic regulations or your personal judgment or knowledge of safe driving practices.
- **Route Safety:** Do not follow the route suggestions if doing so would result in an unsafe or illegal maneuver, if you would be placed in an unsafe situation, or if you would be directed into an area that you consider unsafe. The driver is ultimately responsible for the safe operation of the vehicle and therefore, must evaluate whether it is safe to follow the suggested directions.
- **Potential Map Inaccuracy:** Maps used by this system may be inaccurate because of changes in roads, traffic controls or driving conditions. Always use good judgment and common sense when following the suggested routes.
- **Emergency Services:** Do not rely on any navigation features included in the system to route you to emergency services. Ask local authorities or an emergency services operator for these locations. Not all emergency services such as police, fire stations, hospitals and clinics are likely to be contained in the map database for such navigation features.

Your Responsibilities and Assumptions of Risk

- You agree to each of the following: (a) Any use of the SOFTWARE while driving an automobile or other vehicle in violation of applicable law or otherwise driving in an unsafe manner presents a significant risk of distracted driving and should not be attempted under any circumstances; (b) Use of the SOFTWARE at excessive volume poses a significant risk of hearing damage and should not be attempted under any circumstances; (c) The SOFTWARE may not be compatible with new or different versions of an operating system, third party software, or third party services, and the SOFTWARE may potentially cause a critical failure of an operating system, third party software, or third party service; (d) Any third party service accessed by or third party software used with the SOFTWARE (i) may charge an additional fee for access, (ii) may not work correctly, on an uninterrupted basis, or error free, (iii) may change streaming formats or discontinue operation, (iv) may contain adult, profane or offensive content; and (v) may contain inaccurate, false or misleading traffic, weather, financial or safety information or other content; and (e) Use of the SOFTWARE may cause you to incur additional charges from your wireless service provider (WSP) and any data or minute calculators that may be included in the software program are for reference only, are not warranted in any way and should not be relied upon in anyway.
- When using the SOFTWARE, you agree to be responsible for and assume the entire risk to the items set forth in Section (a) – (e) above.

Appendices

Disclaimer of Warranty

YOU EXPRESSLY ACKNOWLEDGE AND AGREE THAT USE OF THE DEVICES AND SOFTWARE IS AT YOUR SOLE RISK AND THAT THE ENTIRE RISK AS TO SATISFACTORY QUALITY, PERFORMANCE, COMPATIBILITY, ACCURACY AND EFFORT IS WITH YOU. TO THE MAXIMUM EXTENT PERMITTED BY APPLICABLE LAW, THE SOFTWARE AND ANY THIRD PARTY SOFTWARE OR THIRD-PARTY SERVICES ARE PROVIDED "AS IS" AND "AS AVAILABLE", WITH ALL FAULTS AND WITHOUT WARRANTY OF ANY KIND, AND FORD MOTOR COMPANY HEREBY DISCLAIMS ALL WARRANTIES AND CONDITIONS WITH RESPECT TO THE SOFTWARE, THIRD PARTY SOFTWARE, AND THIRD-PARTY SERVICES, EITHER EXPRESS, IMPLIED OR STATUTORY, INCLUDING, BUT NOT LIMITED TO, THE IMPLIED WARRANTIES AND/OR CONDITIONS OF MERCHANTABILITY, OF SATISFACTORY QUALITY, OF FITNESS FOR AN PARTICULAR PURPOSE, OF ACCURACY, OF QUIET ENJOYMENT, AND NON-INFRINGEMENT OF THIRD-PARTY RIGHTS. FORD MOTOR COMPANY DOES NOT WARRANT (a) AGAINST INTERFERENCE WITH YOUR ENJOYMENT OF THE SOFTWARE, THIRD PARTY SOFTWARE, OR THIRD-PARTY SERVICES, (b) THAT THE SOFTWARE, THIRD PARTY SOFTWARE, OR THIRD-PARTY SERVICES WILL MEET YOUR REQUIREMENTS, (c) THAT THE OPERATION OF THE SOFTWARE, THIRD PARTY SOFTWARE, OR THIRD-PARTY SERVICES WILL BE UNINTERRUPTED OR ERROR-FREE, (d) OR THAT DEFECTS IN THE SOFTWARE, THIRD PARTY SOFTWARE, OR THIRD-PARTY SERVICES WILL BE CORRECTED. NO ORAL OR WRITTEN INFORMATION OR ADVICE GIVEN BY FORD MOTOR COMPANY OR ITS AUTHORIZED REPRESENTATIVE SHALL

CREATE A WARRANTY. SHOULD THE SOFTWARE, THIRD PARTY SOFTWARE, OR THIRD-PARTY SERVICES PROVE DEFECTIVE, YOU ASSUME THE ENTIRE COST OF ALL NECESSARY SERVICING, REPAIR OR CORRECTION. SOME JURISDICTIONS DO NOT ALLOW THE DISCLAIMER OF IMPLIED WARRANTIES OR LIMITATIONS ON APPLICABLE STATUTORY RIGHTS OF A CONSUMER, SO THE ABOVE DISCLAIMER MAY NOT FULLY APPLY TO YOU. THE SOLE WARRANTY PROVIDED BY FORD MOTOR COMPANY SHALL BE FOUND IN THE WARRANTY INFORMATION INCLUDING WITH YOUR OWNER GUIDE. TO THE EXTENT THAT THERE IS ANY CONFLICT BETWEEN THE TERMS OF THIS SECTION AND THE WARRANTY BOOKLET, THE WARRANTY BOOKLET SHALL CONTROL.

Applicable Law, Venue, Jurisdiction

- The laws of the State of Michigan govern this EULA and Your use of the SOFTWARE. Your use of the SOFTWARE may also be subject to other local, state, national, or international laws. Any litigation arising out of or related to this EULA shall be brought and maintained exclusively in a court of the State of Michigan located in Wayne County or in the United States District Court for the Eastern District of Michigan. You hereby consent to submit to the personal jurisdiction of a court in the State of Michigan located in Wayne County and the United States District Court for the Eastern District of Michigan for any dispute arising out of or relating to this EULA.

Appendices

Binding Arbitration and Class Action Waiver

(a) Application. This Section applies to any dispute EXCEPT IT DOES NOT INCLUDE A DISPUTE RELATING TO COPYRIGHT INFRINGEMENT, OR TO THE ENFORCEMENT OR VALIDITY OF YOUR, FORD MOTOR COMPANY, OR ANY OF FORD MOTOR COMPANY'S LICENSORS' INTELLECTUAL PROPERTY RIGHTS. Dispute means any dispute, action, or other controversy between You and FORD MOTOR COMPANY, other than the exceptions listed above, concerning the SOFTWARE (including its price) or this EULA, whether in contract, warranty, tort, statute, regulation, ordinance, or any other legal or equitable basis.

(b) Notice of Dispute. In the event of a Dispute, You or FORD MOTOR COMPANY must give the other a "Notice of Dispute", which is a written statement of the name, address, and contact information of the party giving it, the facts giving rise to the dispute, and the relief requested. You and FORD MOTOR COMPANY will attempt to resolve any dispute through informal negotiation within 60 days from the date the Notice of Dispute is sent. After 60 days, You or FORD MOTOR COMPANY may commence arbitration.

(c) Small claims court. You may also litigate any dispute in small claims court in your county of residence or FORD MOTOR COMPANY'S principal place of business, if the dispute meets all requirements to be heard in the small claims court. You may litigate in small claims court whether or not You negotiated informally first.

(d) Binding arbitration. If You and FORD MOTOR COMPANY, do not resolve any dispute by informal negotiation or in small claims court, any other effort to resolve the dispute will be conducted exclusively by binding arbitration. You are giving up

the right to litigate (or participate in as a party or class member) all disputes in court before a judge or jury. Instead, all disputes will be resolved before a neutral arbitrator, whose decision will be final except for a limited right of appeal under the Federal Arbitration Act. Any court with jurisdiction over the parties may enforce the arbitrator's award.

(e) Class action waiver. Any proceedings to resolve or litigate any dispute in any forum will be conducted solely on an individual basis. Neither you nor FORD MOTOR COMPANY, will seek to have any dispute heard as a class action, as a private attorney general action, or in any other proceeding in which any party acts or proposes to act in a representative capacity. No arbitration or proceeding will be combined with another without the prior written consent of all parties to all affected arbitrations or proceedings.

(f) Arbitration procedure. Any arbitration will be conducted by the American Arbitration Association (the "AAA"), under its Commercial Arbitration Rules. If You are an individual and use the SOFTWARE for personal or vehicle use, or if the value of the dispute is \$75,000 or less whether or not You are an individual or how You use the SOFTWARE, the AAA Supplementary Procedures for Consumer-Related Disputes will also apply. To commence arbitration, submit a Commercial Arbitration Rules Demand for Arbitration form to the AAA. You may request a telephonic or in-person hearing by following the AAA rules. In a dispute involving \$10,000 or less, any hearing will be telephonic unless the arbitrator finds good cause to hold an in-person hearing instead. For more information, see adr.org or call 1-800-778-7879. You agree to commence arbitration only in your county of residence or FORD MOTOR COMPANY'S principal place of business. The arbitrator

Appendices

may award the same damages to You individually as a court could. The arbitrator may award declaratory or injunctive relief only to You individually, and only to the extent required to satisfy Your individual claim.

(g) Arbitration fees and incentives.

- I. Disputes involving \$75,000 or less. FORD MOTOR COMPANY will promptly reimburse your filing fees and pay the AAA's and arbitrator's fees and expenses. If you reject FORD MOTOR COMPANY'S last written settlement offer made before the arbitrator was appointed ("last written offer"), your dispute goes all the way to an arbitrator's decision (called an "award"), and the arbitrator awards you more than the last written offer, FORD MOTOR COMPANY will give you three incentives: (1) pay the greater of the award or \$1,000; (2) pay twice your reasonable attorney's fees, if any; and (3) reimburse any expenses (including expert witness fees and costs) that your attorney reasonably accrues for investigating, preparing, and pursuing your claim in arbitration. The arbitrator will determine the amounts.
- ii. Disputes involving more than \$75,000. The AAA rules will govern payment of filing fees and the AAA's and arbitrator's fees and expenses.
- iii. Disputes involving any amount. In any arbitration you commence, FORD MOTOR COMPANY will seek its AAA or arbitrator's fees and expenses, or Your filing fees it reimbursed, only if the arbitrator finds the arbitration frivolous or brought for an improper purpose. In any arbitration FORD MOTOR COMPANY commences, it will pay all

filing, AAA, and arbitrator's fees and expenses. It will not seek its attorney's fees or expenses from you in any arbitration. Fees and expenses are not counted in determining how much a dispute involves.

(h) Claims or disputes must be filed within one year. To the extent permitted by law, any claim or dispute under this EULA to which this Section applies must be filed within one year in small claims court (Section c) or in arbitration (Section d). The one-year period begins when the claim or dispute first could be filed. If such a claim or dispute is not filed within one year, it is permanently barred.

(i) Severability. If the class action waiver (Section e) is found to be illegal or unenforceable as to all or some parts of a dispute, then that portion of Section e will not apply to those parts. Instead, those parts will be severed and proceed in a court of law, with the remaining parts proceeding in arbitration. If any other provision of that portion Section e is found to be illegal or unenforceable, that provision will be severed with the remainder of Section e remaining in full force and effect.

Telenav Software End User License Agreement

Please read these terms and conditions carefully before you use the TeleNav Software. Your use of the TeleNav Software indicates that you accept these terms and conditions. If you do not accept these terms and conditions, do not break the seal of the package, launch, or otherwise use the TeleNav Software. TeleNav may revise this Agreement and the privacy policy at any time, with or without notice to you. You agree to visit <http://www.telenav.com> from time to time to review the then current version of this Agreement and of the privacy policy.

Appendices

1. Safe and Lawful Use

You acknowledge that devoting attention to the TeleNav Software may pose a risk of injury or death to you and others in situations that otherwise require your undivided attention, and you therefore agree to comply with the following when using the TeleNav Software:

- (a) observe all traffic laws and otherwise drive safely;
- (b) use your own personal judgment while driving. If you feel that a route suggested by the TeleNav Software instructs you to perform an unsafe or illegal maneuver, places you in an unsafe situation, or directs you into an area that you consider to be unsafe, do not follow such instructions;
- (c) do not input destinations, or otherwise manipulate the TeleNav Software, unless your vehicle is stationary and parked;
- (d) do not use the TeleNav Software for any illegal, unauthorized, unintended, unsafe, hazardous, or unlawful purposes, or in any manner inconsistent with this Agreement;
- (e) arrange all GPS and wireless devices and cables necessary for use of the TeleNav Software in a secure manner in your vehicle so that they will not interfere with your driving and will not prevent the operation of any safety device (such as an airbag).

You agree to indemnify and hold TeleNav harmless against all claims resulting from any dangerous or otherwise inappropriate use of the TeleNav Software in any moving vehicle, including as a result of your failure to comply with the directions above.

2. Account Information

You agree: (a) when registering the TeleNav Software, to provide TeleNav with true, accurate, current, and complete information about yourself, and (b) to inform TeleNav promptly of any changes to such information, and to keep it true, accurate, current and complete.

3. Software License

- Subject to your compliance with the terms of this Agreement, TeleNav hereby grants to you a personal, non-exclusive, non-transferable license (except as expressly permitted below in connection with your permanent transfer of the TeleNav Software license), without the right to sublicense, to use the TeleNav Software (in object code form only) in order to access and use the TeleNav Software. This license shall terminate upon any termination or expiration of this Agreement. You agree that you will use the TeleNav Software only for your personal business or leisure purposes, and not to provide commercial navigation services to other parties.

3.1 License Limitations

- **(a)** reverse engineer, decompile, disassemble, translate, modify, alter or otherwise change the TeleNav Software or any part thereof; **(b)** attempt to derive the source code, audio library or structure of the TeleNav Software without the prior express written consent of TeleNav; **(c)** remove from the TeleNav Software, or alter, any of TeleNav's or its suppliers' trademarks, trade names, logos, patent or copyright notices, or other notices or markings; **(d)**

Appendices

distribute, sublicense or otherwise transfer the TeleNav Software to others, except as part of your permanent transfer of the TeleNav Software; or **(e)** use the TeleNav Software in any manner that

- i. infringes the intellectual property or proprietary rights, rights of publicity or privacy or other rights of any party,
- ii. violates any law, statute, ordinance or regulation, including but not limited to laws and regulations related to spamming, privacy, consumer and child protection, obscenity or defamation, or
- iii. is harmful, threatening, abusive, harassing, tortuous, defamatory, vulgar, obscene, libelous, or otherwise objectionable; and (f) lease, rent out, or otherwise permit unauthorized access by third parties to the TeleNav Software without advanced written permission of TeleNav.

4. Disclaimers

- To the fullest extent permissible pursuant to applicable law, in no event will TeleNav, its licensors and suppliers, or agents or employees of any of the foregoing, be liable for any decision made or action taken by you or anyone else in reliance on the information provided by the TeleNav Software. TeleNav also does not warrant the accuracy of the map or other data used for the TeleNav Software. Such data may not always reflect reality due to, among other things, road closures, construction, weather, new roads and other changing conditions. You are responsible for the entire risk arising out of your use of the TeleNav Software. For example but without limitation, you agree not to rely on the TeleNav Software for critical navigation in areas where the well-being or survival of you or others

is dependent on the accuracy of navigation, as the maps or functionality of the TeleNav Software are not intended to support such high risk applications, especially in more remote geographical areas.

- TELENAV EXPRESSLY DISCLAIMS AND EXCLUDES ALL WARRANTIES IN CONNECTION WITH THE TELENAV SOFTWARE, WHETHER STATUTORY, EXPRESS OR IMPLIED, INCLUDING ALL WARRANTIES WHICH MAY ARISE FROM COURSE OF DEALING, CUSTOM OR TRADE AND INCLUDING, BUT NOT LIMITED TO, THE IMPLIED WARRANTIES OF MERCHANTABILITY, FITNESS FOR A PARTICULAR PURPOSE AND NON-INFRINGEMENT OF THIRD PARTY RIGHTS WITH RESPECT TO THE TELENAV SOFTWARE.
- Certain jurisdictions do not permit the disclaimer of certain warranties, so this limitation may not apply to you.

5. Limitation of Liability

- TO THE EXTENT PERMITTED UNDER APPLICABLE LAW, UNDER NO CIRCUMSTANCES SHALL TELENAV OR ITS LICENSORS AND SUPPLIERS BE LIABLE TO YOU OR TO ANY THIRD PARTY FOR ANY INDIRECT, INCIDENTAL, CONSEQUENTIAL, SPECIAL OR EXEMPLARY DAMAGES (INCLUDING IN EACH CASE, BUT NOT LIMITED TO, DAMAGES FOR THE INABILITY TO USE THE EQUIPMENT OR ACCESS DATA, LOSS OF DATA, LOSS OF BUSINESS, LOSS OF PROFITS, BUSINESS INTERRUPTION OR THE LIKE) ARISING OUT OF THE USE OF OR INABILITY TO USE THE TELENAV SOFTWARE, EVEN IF TELENAV HAS BEEN ADVISED OF THE POSSIBILITY OF SUCH DAMAGES. NOTWITHSTANDING ANY DAMAGES THAT YOU MIGHT INCUR FOR ANY

Appendices

REASON WHATSOEVER (INCLUDING, WITHOUT LIMITATION, ALL DAMAGES REFERENCED HEREIN AND ALL DIRECT OR GENERAL DAMAGES IN CONTRACT, TORT (INCLUDING NEGLIGENCE) OR OTHERWISE), THE ENTIRE LIABILITY OF TELENAV AND OF ALL OF TELENAV'S SUPPLIERS SHALL BE LIMITED TO THE AMOUNT ACTUALLY PAID BY YOU FOR THE TELENAV SOFTWARE. SOME STATES AND/OR JURISDICTIONS DO NOT ALLOW THE EXCLUSION OR LIMITATION OF INCIDENTAL OR CONSEQUENTIAL DAMAGES, SO THE ABOVE LIMITATIONS OR EXCLUSIONS MAY NOT APPLY TO YOU.

6. Arbitration and Governing Law

- You agree that any dispute, claim or controversy arising out of or relating to this Agreement or the TeleNav Software shall be settled by independent arbitration involving a neutral arbitrator and administered by the American Arbitration Association in the County of Santa Clara, California. The arbitrator shall apply the Commercial Arbitration Rules of the American Arbitration Association, and the judgment upon the award rendered by the arbitrator may be entered by any court having jurisdiction. Note that there is no judge or jury in an arbitration proceeding and the decision of the arbitrator shall be binding upon both parties. You expressly agree to waive your right to a jury trial. This Agreement and performance hereunder will be governed by and construed in accordance with the laws of the State of California, without giving effect to its conflict of law provisions. To the extent judicial action is necessary in connection with the binding arbitration, both TeleNav and you agree to submit

to the exclusive jurisdiction of the courts of the County of Santa Clara, California. The United Nations Convention on Contracts for the International Sale of Goods shall not apply.

7. Assignment

- You may not resell, assign, or transfer this Agreement or any of your rights or obligations, except in totality, in connection with your permanent transfer of the TeleNav Software, and expressly conditioned upon the new user of the TeleNav Software agreeing to be bound by the terms and conditions of this Agreement. Any such sale, assignment or transfer that is not expressly permitted under this paragraph will result in immediate termination of this Agreement, without liability to TeleNav, in which case you and all other parties shall immediately cease all use of the TeleNav Software. Notwithstanding the foregoing, TeleNav may assign this Agreement to any other party at any time without notice, provided the assignee remains bound by this Agreement.

8. Miscellaneous

8.1

This Agreement constitutes the entire agreement between TeleNav and you with respect to the subject matter hereof.

8.2

Except for the limited licenses expressly granted in this Agreement, TeleNav retains all right, title and interest in and to the TeleNav Software, including without limitation all related intellectual property rights. No licenses or other rights which are not expressly granted in this Agreement are intended to, or shall be, granted or

Appendices

conferred by implication, statute, inducement, estoppel or otherwise, and TeleNav and its suppliers and licensors hereby reserve all of their respective rights other than the licenses explicitly granted in this Agreement.

8.3

By using the TeleNav Software, you consent to receive from TeleNav all communications, including notices, agreements, legally required disclosures or other information in connection with the TeleNav Software (collectively, "Notices") electronically. TeleNav may provide such Notices by posting them on TeleNav's Website or by downloading such Notices to your wireless device. If you desire to withdraw your consent to receive Notices electronically, you must discontinue your use of the TeleNav Software.

8.4

TeleNav's or your failure to require performance of any provision shall not affect that party's right to require performance at any time thereafter, nor shall a waiver of any breach or default of this Agreement constitute a waiver of any subsequent breach or default or a waiver of the provision itself.

8.5

If any provision herein is held unenforceable, then such provision will be modified to reflect the intention of the parties, and the remaining provisions of this Agreement will remain in full force and effect.

8.6

The headings in this Agreement are for convenience of reference only, will not be deemed to be a part of this Agreement, and will not be referred to in connection with the construction or interpretation of this Agreement. As used in this Agreement, the words "include" and "including" and variations thereof, will not be deemed to be terms of limitation, but rather will be deemed to be followed by the words "without limitation".

9. Other Vendors Terms and Conditions

- The Telenav Software utilizes map and other data licensed to Telenav by third party vendors for the benefit of you and other end users. This Agreement includes end-user terms applicable to these companies (included at the end of this Agreement), and thus your use of the Telenav Software is also subject to such terms. You agree to comply with the following additional terms and conditions, which are applicable to Telenav's third party vendor licensors:

9.1 End User Terms Required by HERE North America, LLC

The data ("Data") is provided for your personal, internal use only and not for resale. It is protected by copyright, and is subject to the following terms and conditions which are agreed to by you, on the one hand, and Telenav ("Telenav") and its licensors (including their licensors and suppliers) on the other hand.

© 2013 HERE. All rights reserved.

The Data for areas of Canada includes information taken with permission from Canadian authorities, including: © Her Majesty the Queen in Right of Canada, © Queen's Printer for Ontario, © Canada Post Corporation, GeoBase®, © Department of Natural Resources Canada.

Appendices

HERE holds a non-exclusive license from the United States Postal Service® to publish and sell ZIP+4® information.

©United States Postal Service® 2014. Prices are not established, controlled or approved by the United States Postal Service®. The following trademarks and registrations are owned by the USPS: United States Postal Service, USPS, and ZIP+4

The Data for Mexico includes certain data from Instituto Nacional de Estadística y Geografía.

9.2 End User Terms Required by NAV2 (Shanghai) Co., Ltd

The data (“Data”) is provided for your personal, internal use only and not for resale. It is protected by copyright, and is subject to the following terms and conditions which are agreed to by you, on the one hand, and NAV2 (Shanghai) Co., Ltd (“NAV2”) and its licensors (including their licensors and suppliers) on the other hand. 20xx. All rights reserved

Terms and Conditions

Permitted Use. You agree to use this Data together with the Telenav Software solely for the internal business and personal purposes for which you were licensed, and not for service bureau, time-sharing or other similar purposes. Accordingly, but subject to the restrictions set forth in the following paragraphs, you agree not to otherwise reproduce, copy, modify, decompile, disassemble, create any derivative works of, or reverse engineer any portion of this Data, and may not transfer or distribute it in any form, for any purpose, except to the extent permitted by mandatory laws.

Restrictions. Except where you have been specifically licensed to do so by Telenav, and without limiting the preceding paragraph, you may not use this Data (a) with any products, systems, or applications installed or otherwise connected to or in communication with vehicles, capable of vehicle navigation, positioning, dispatch, real time route guidance, fleet management or similar applications; or (b) with or in communication with any positioning devices or any mobile or wireless-connected electronic or computer devices, including without limitation cellular phones, palmtop and handheld computers, pagers, and personal digital assistants or PDAs.

Warning. The Data may contain inaccurate or incomplete information due to the passage of time, changing circumstances, sources used and the nature of collecting comprehensive geographic data, any of which may lead to incorrect results.

No Warranty. This Data is provided to you “as is,” and you agree to use it at your own risk. Telenav and its licensors (and their licensors and suppliers) make no guarantees, representations or warranties of any kind, express or implied, arising by law or otherwise, including but not limited to, content, quality, accuracy, completeness, effectiveness, reliability, fitness for a particular purpose, usefulness, use or results to be obtained from this Data, or that the Data or server will be uninterrupted or error-free.

Disclaimer of Warranty: TELENAV AND ITS LICENSORS (INCLUDING THEIR LICENSORS AND SUPPLIERS) DISCLAIM ANY WARRANTIES, EXPRESS OR IMPLIED, OF QUALITY, PERFORMANCE, MERCHANTABILITY, FITNESS FOR A

Appendices

PARTICULAR PURPOSE OR NON-INFRINGEMENT. Some States, Territories and Countries do not allow certain warranty exclusions, so to that extent the above exclusion may not apply to you.

Disclaimer of Liability: TELENAV AND ITS LICENSORS (INCLUDING THEIR LICENSORS AND SUPPLIERS) SHALL NOT BE LIABLE TO YOU: IN RESPECT OF ANY CLAIM, DEMAND OR ACTION, IRRESPECTIVE OF THE NATURE OF THE CAUSE OF THE CLAIM, DEMAND OR ACTION ALLEGING ANY LOSS, INJURY OR DAMAGES, DIRECT OR INDIRECT, WHICH MAY RESULT FROM THE USE OR POSSESSION OF THE INFORMATION; OR FOR ANY LOSS OF PROFIT, REVENUE, CONTRACTS OR SAVINGS, OR ANY OTHER DIRECT, INDIRECT, INCIDENTAL, SPECIAL OR CONSEQUENTIAL DAMAGES ARISING OUT OF YOUR USE OF OR INABILITY TO USE THIS INFORMATION, ANY DEFECT IN THE INFORMATION, OR THE BREACH OF THESE TERMS OR CONDITIONS, WHETHER IN AN ACTION IN CONTRACT OR TORT OR BASED ON A WARRANTY, EVEN IF TELENAV OR ITS LICENSORS HAVE BEEN ADVISED OF THE POSSIBILITY OF SUCH DAMAGES. Some States, Territories and Countries do not allow certain liability exclusions or damages limitations, so to that extent the above may not apply to you.

Export Control. You shall not export from anywhere any part of the Data or any direct product thereof except in compliance with, and with all licenses and approvals required under, applicable export laws, rules and regulations, including but not limited to the laws, rules and regulations administered by the Office of Foreign Assets Control of the U.S. Department of Commerce and the Bureau of Industry and Security of the U.S. Department of Commerce. To the extent that any such

export laws, rules or regulations prohibit HERE from complying with any of its obligations hereunder to deliver or distribute Data, such failure shall be excused and shall not constitute a breach of this Agreement.

Entire Agreement. These terms and conditions constitute the entire agreement between Telenav (and its licensors, including their licensors and suppliers) and you pertaining to the subject matter hereof, and supersedes in their entirety any and all written or oral agreements previously existing between us with respect to such subject matter.

Governing Law. The above terms and conditions shall be governed by the laws of the State of Illinois [insert "Netherlands" where European HERE Data is used], without giving effect to (i) its conflict of laws provisions, or (ii) the United Nations Convention for Contracts for the International Sale of Goods, which is explicitly excluded. You agree to submit to the jurisdiction of the State of Illinois [insert "The Netherlands" where European HERE Data is used] for any and all disputes, claims and actions arising from or in connection with the Data provided to you hereunder.

Government End Users. If the Data is being acquired by or on behalf of the United States government or any other entity seeking or applying rights similar to those customarily claimed by the United States government, this Data is a "commercial item" as that term is defined at 48 C.F.R. ("FAR") 2.101, is licensed in accordance with these End-User Terms, and each copy of Data delivered or otherwise furnished shall be marked and embedded as appropriate with the following "Notice of Use," and shall be treated in accordance with such Notice:

Appendices

NOTICE OF USE

CONTRACTOR (MANUFACTURER/
SUPPLIER) NAME: HERE

CONTRACTOR (MANUFACTURER/
SUPPLIER) ADDRESS: c/o Nokia, 425
West Randolph Street, Chicago, Illinois
60606

This Data is a commercial item as
defined in FAR 2.101 and is subject to
these End-User Terms under which this
Data was provided.

© 1987 – 2014 HERE – All rights reserved.

If the Contracting Officer, federal government agency, or any federal official refuses to use the legend provided herein, the Contracting Officer, federal government agency, or any federal official must notify HERE prior to seeking additional or alternative rights in the Data.

I. US/Canada Territory

A. United States Data. The End-User Terms for any Application containing Data for the United States shall contain the following notices:

“HERE holds a non-exclusive license from the United States Postal Service® to publish and sell ZIP+4® information.”

“©United States Postal Service® 20XX. Prices are not established, controlled or approved by the United States Postal Service®. The following trademarks and registrations are owned by the USPS: United States Postal Service, USPS, and ZIP+4.”

B. Canada Data. The following provisions apply to the Data for Canada, which may include or reflect data from third party licensors (“Third Party Data”), including Her Majesty the Queen in Right of Canada (“Her Majesty”), Canada Post Corporation (“Canada Post”) and the Department of Natural Resources of Canada (“NRCan”):

1. Disclaimer and Limitation: Client agrees that its use of the Third Party Data is subject to the following provisions:

a. Disclaimer: The Third Party Data is licensed on an “as is” basis. The licensors of such data, including Her Majesty, Canada Post and NRCan, make no guarantees, representations or warranties respecting such data, either express or implied, arising by law or otherwise, including but not limited to, effectiveness, completeness, accuracy or fitness for a particular purpose.

b. Limitation on Liability: The Third Party Data licensors, including Her Majesty, Canada Post and NRCan, shall not be liable: (i) in respect of any claim, demand or action, irrespective of the nature of the cause of the claim, demand or action alleging any loss, injury or damages, direct or indirect, which may result from the use or possession of such Data; or (ii) in any way for loss of revenues or contracts, or any other consequential loss of any kind resulting from any defect in the Data.

Appendices

2. Copyright Notice: In connection with each copy of all or any portion of the Data for the Territory of Canada, Client shall affix in a conspicuous manner the following copyright notice on at least one of: (i) the label for the storage media of the copy; (ii) the packaging for the copy; or (iii) other materials packaged with the copy, such as user manuals or end user license agreements: "This data includes information taken with permission from Canadian authorities, including © Her Majesty the Queen in Right of Canada, © Queen's Printer for Ontario, © Canada Post Corporation, GeoBase®, © The Department of Natural Resources Canada. All rights reserved!"

3. End-User Terms: Except as otherwise agreed by the parties, in connection with the provision of any portion of the Data for the Territory of Canada to End-Users as may be authorized under the Agreement, Client shall provide such End-Users, in a reasonably conspicuous manner, with terms (set forth with other end user terms required to be provided under the Agreement, or as otherwise may be provided, by Client) which shall include the following provisions on behalf of the Third Party Data licensors, including Her Majesty, Canada Post and NRCan:

The Data may include or reflect data of licensors, including Her Majesty the Queen in the Right of Canada ("Her Majesty"), Canada Post Corporation ("Canada Post") and the Department of Natural Resources Canada ("NRCan"). Such data is licensed on an "as is" basis. The licensors, including Her Majesty, Canada Post and NRCan, make no guarantees, representations or warranties respecting such data,

either express or implied, arising by law or otherwise, including but not limited to, effectiveness, completeness, accuracy or fitness for a particular purpose. The licensors, including Her Majesty, Canada Post and NRCan, shall not be liable in respect of any claim, demand or action, irrespective of the nature of the cause of the claim, demand or action alleging any loss, injury or damages, direct or indirect, which may result from the use or possession of the data or the Data. The licensors, including Her Majesty, Canada Post and NRCan, shall not be liable in any way for loss of revenues or contracts, or any other consequential loss of any kind resulting from any defect in the data or the Data.

End User shall indemnify and save harmless the licensors, including Her Majesty, Canada Post and NRCan, and their officers, employees and agents from and against any claim, demand or action, irrespective of the nature of the cause of the claim, demand or action, alleging loss, costs, expenses, damages or injuries (including injuries resulting in death) arising out of the use or possession of the data or the Data.

4. Additional Provisions: The terms contained in this Section are in addition to all of the rights and obligations of the parties under the Agreement. To the extent that any of the provisions of this Section are inconsistent with, or conflict with, any other provisions of the Agreement, the provisions of this Section shall prevail.

Appendices

II. Mexico. The following provision applies to the Data for Mexico, which includes certain data from the Instituto Nacional de Estadística y Geografía (“INEGI”):

A. Any and all copies of the Data and/or packaging containing Data for Mexico shall contain the following notice: “Fuente: INEGI (Instituto Nacional de Estadística y Geografía)”

III. Latin America Territory

A. Third Party Notices. Any and all copies of the Data and/or packaging relating thereto shall include the respective Third Party Notices set forth below and used as described below corresponding to the Territory (or portion thereof) included in such copy:

Territory Notice

Argentina IGN “INSTITUTO GEOGRAFICO NACIONAL ARGENTINO”

Ecuador “INSTITUTO GEOGRAFICO MILITAR DEL ECUADOR AUTORIZACION N° IGM-2011-01- PCO-01 DEL 25 DE ENERO DE 2011”
“source: © IGN 2009 - BD TOPO ®”

Guadeloupe, French Guiana and Martinique Mexico “Fuente: INEGI (Instituto Nacional de Estadística y Geografía)”

IV. Middle East Territory

A. Third Party Notices. Any and all copies of the Data and/or packaging relating thereto shall include the respective Third Party Notices set forth below and used as described below corresponding to the Territory (or portion thereof) included in such copy:

Country Notice

Jordan “© Royal Jordanian Geographic Centre”. The foregoing notice requirement for Jordan Data is a material term of the Agreement. If Client or any of its permitted sublicensees (if any) fail to meet such requirement, HERE shall have the right to terminate Client’s license with respect to the Jordan Data.

B. Jordan Data. Client and its permitted sublicensees (if any) are restricted from licensing and/or otherwise distributing HERE’s database for the country of Jordan (“Jordan Data”) for use in Enterprise Applications to (i) non-Jordanian entities for use of the Jordan Data solely in Jordan or (ii) Jordan-based customers. In addition, Client, its permitted sublicensees (if any) and End-Users are restricted from using the Jordan Data in Enterprise Applications if such party is (i) a non-Jordanian entity using the Jordan Data solely in Jordan or (ii) a Jordan-based customer. For purposes of the foregoing, “Enterprise Applications” shall mean Geomarketing applications, GIS applications, mobile business asset management applications, call center applications, telematics applications, public organization Internet applications or for providing geocoding services.

Appendices

V. Europe Territory

A. Use of Certain Traffic Codes in Europe

1. General Restrictions Applicable to Traffic Codes. Client acknowledges and agrees that in certain countries of the Europe Territory, Client will need to obtain rights directly from third party RDS-TMC code providers to receive and use the Traffic Codes in the Data and to deliver to End-Users Transactions in any way derived from or based on such Traffic Codes. For such countries, HERE shall deliver the Data incorporating Traffic Codes to Client only after receiving certification from Client of its having obtained such rights.

2. Display of Third Party Rights Legends for Belgium. Client shall, for each Transaction that uses Traffic Codes for Belgium, provide the following notice to the End-User: "Traffic Codes for Belgium are provided by the Ministerie van de Vlaamse Gemeenschap and the Ministère de l'Équipement et des Transports."

B. Paper Maps. With respect to any license granted to Client relating to making, selling or distributing paper maps (i.e., a map fixed on a paper or paper-like medium): (a) such license with respect to Data for the Territory of Great Britain is conditioned on Client's entering into and complying with a separate written agreement with the Ordnance Survey ("OS") to create and sell paper maps, Client's paying to the OS any and all applicable paper map royalties, and Client's complying with the OS copyright notice requirements; (b) such license for selling or otherwise distributing for charge with respect to Data for the Territory of Czech Republic

is conditioned on Client's obtaining prior written consent from Kartografie a.s.; (c) such license for selling or distributing with respect to Data for the Territory of Switzerland is conditioned on Client's obtaining a permit from Bundesamt für Landestopografie of Switzerland; (d) Client is restricted from using Data for the Territory of France to create paper maps with a scale between 1:5,000 and 1:250,000; and (e) Client is restricted from using any Data to create, sell or distribute paper maps that are the same or substantially similar, in terms of data content and specific use of color, symbols and scale, to paper maps published by the European national mapping agencies, including without limitation, Landvermessungämter of Germany, Topografische Dienst of the Netherlands, Nationaal Geografisch Instituut of Belgium, Bundesamt für Landestopografie of Switzerland, Bundesamt für Eich-und Vermessungswesen of Austria, and the National Land Survey of Sweden.

C. OS Enforcement. Without limiting Section IV(B) above, with respect to Data for the Territory of Great Britain, Client acknowledges and agrees that the Ordnance Survey ("OS") may bring a direct action against Client to enforce compliance with the OS copyright notice (see Section IV(D) below) and paper map requirements (see Section IV(B) above) contained in this Agreement.

D. Third Party Notices. Any and all copies of the Data and/or packaging relating thereto shall include the respective Third Party Notices set forth below and used as described below corresponding to the Territory (or portion thereof) included in such copy:

Country(ies) Notice

Appendices

Austria	“© Bundesamt für Eich- und Vermessungswesen”
Croatia Cyprus, Estonia, Latvia, Lithuania, Moldova, Poland, Slovenia and/or Ukraine	“© EuroGeographics”
France	“source: © IGN 2009 – BD TOPO ®”
Germany	“Die Grundlagendaten wurden mit Genehmigung der zuständigen Behörden entnommen”
Great Britain	“Contains Ordnance Survey data © Crown copyright and database right 2010 Contains Royal Mail data © Royal Mail copyright and database right 2010”
Greece	“Copyright Geomatics Ltd.”
Hungary	“Copyright © 2003; Top-Map Ltd.”
Italy	“La Banca Dati Italiana è stata prodotta usando quale riferimento anche cartografia numerica ed al tratto prodotta e fornita dalla Regione Toscana.”
Norway	“Copyright © 2000; Norwegian Mapping Authority”
Portugal	“Source: IgeoE – Portugal”

Spain	“Información geográfica propiedad del CNIG”
Sweden	“Based upon electronic data © National Land Survey Sweden.”
Switzerland	“Topografische Grundlage: © Bundesamt für Landestopographie.

E. Respective Country Distribution. Client acknowledges that HERE has not received approvals to distribute map data for the following countries in such respective countries: Albania, Belarus, Kyrgyzstan, Moldova and Uzbekistan. HERE may update such list from time to time. The license rights granted to Client under this TL with respect to the Data for such countries are contingent upon Client’s compliance with all applicable laws and regulations, including, without limitation, any required licenses or approvals to distribute the Application incorporating such Data in such respective countries.

VI. Australia Territory

A. Third Party Notices. Any and all copies of the Data and/or packaging relating thereto shall include the respective Third Party Notices set forth below and used as described below corresponding to the Territory (or portion thereof) included in such copy:

Copyright. Based on data provided under license from PSMA Australia Limited (www.pasma.com.au).

Appendices

Product incorporates data which is © 20XX Telstra Corporation Limited, GM Holden Limited, Intelomatics Australia Pty Ltd and Continental Pty Ltd.

B. Third Party Notices for Australia. In addition to the foregoing, the End-User Terms for any Application containing RDS-TMC Traffic Codes for Australia shall contain the following notice: “Product incorporates traffic location codes which is © 20XX Telstra Corporation Limited and its licensors.”

AT&T Vehicle Network Carrier Telematics Disclosure

END USER FOR PURPOSES OF THIS SECTION MEANS YOU AND YOUR HEIRS, EXECUTORS, LEGAL PERSONAL REPRESENTATIVES AND PERMITTED ASSIGNS. FOR PURPOSES OF THIS SECTION “UNDERLYING WIRELESS SERVICE CARRIER” INCLUDES ITS AFFILIATES AND CONTRACTORS AND THEIR RESPECTIVE OFFICERS, DIRECTORS, EMPLOYEES, SUCCESSORS AND ASSIGNS. END USER HAS NO CONTRACTUAL RELATIONSHIP WITH THE UNDERLYING WIRELESS SERVICE CARRIER AND END USER IS NOT A THIRD PARTY BENEFICIARY OF ANY AGREEMENT BETWEEN FORD AND UNDERLYING CARRIER. END USER UNDERSTANDS AND AGREES THAT THE UNDERLYING CARRIER HAS NO LEGAL, EQUITABLE, OR OTHER LIABILITY OF ANY KIND TO END USER. IN ANY EVENT, REGARDLESS OF THE FORM OF THE ACTION, WHETHER FOR BREACH OF CONTRACT, WARRANTY, NEGLIGENCE, STRICT LIABILITY IN TORT OR OTHERWISE, END USER'S EXCLUSIVE REMEDY FOR CLAIMS ARISING IN ANY WAY IN CONNECTION WITH THIS AGREEMENT, FOR ANY CAUSE WHATSOEVER, INCLUDING BUT NOT LIMITED TO ANY FAILURE OR

DISRUPTION OF SERVICE PROVIDED HEREUNDER, IS LIMITED TO PAYMENT OF DAMAGES IN AN AMOUNT NOT TO EXCEED THE AMOUNT PAID BY END USER FOR THE SERVICES DURING THE TWO-MONTH PERIOD PRECEDING THE DATE THE CLAIM AROSE.

(ii) END USER AGREES TO INDEMNIFY AND HOLD HARMLESS THE UNDERLYING WIRELESS SERVICE CARRIER AND ITS OFFICERS, EMPLOYEES, AND AGENTS AGAINST ANY AND ALL CLAIMS, INCLUDING WITHOUT LIMITATION CLAIMS FOR LIBEL, SLANDER, OR ANY PROPERTY DAMAGE, PERSONAL INJURY OR DEATH, ARISING IN ANY WAY, DIRECTLY OR INDIRECTLY, IN CONNECTION WITH THIS AGREEMENT OR THE USE, FAILURE TO USE, OR INABILITY TO USE THE DEVICE EXCEPT WHERE THE CLAIMS RESULT FROM THE UNDERLYING CARRIER'S GROSS NEGLIGENCE OR WILLFUL MISCONDUCT. THIS INDEMNITY WILL SURVIVE THE TERMINATION OF THE AGREEMENT.

(iii) END USER HAS NO PROPERTY RIGHT IN ANY NUMBER ASSIGNED TO THE DEVICE.

(iv) END USER UNDERSTANDS THAT FORD AND THE UNDERLYING CARRIER CANNOT GUARANTY THE SECURITY OF WIRELESS TRANSMISSIONS, AND WILL NOT BE LIABLE FOR ANY LACK OF SECURITY RELATING TO THE USE OF THE SERVICES

THE SERVICE IS FOR [END USER'S] USE ONLY AND END USER MAY NOT RESELL THE SERVICE TO ANY OTHER PARTY END USER UNDERSTANDS THAT THE UNDERLYING CARRIER DOES NOT GUARANTEE ANY END USER UNINTERRUPTED SERVICE OR COVERAGE. THE UNDERLYING CARRIER DOES NOT WARRANT THAT END USERS CAN OR WILL BE LOCATED USING THE SERVICE. THE UNDERLYING CARRIER

Appendices

MAKES NO WARRANTY, EXPRESS OR IMPLIED, OF MERCHANTABILITY OR FITNESS FOR A PARTICULAR PURPOSE, SUITABILITY, OR PERFORMANCE REGARDING ANY SERVICES OR GOODS, AND IN NO EVENT SHALL AT&T BE LIABLE, WHETHER OR NOT DUE TO ITS OWN NEGLIGENCE, FOR ANY: (A) ACT OR OMISSION OF A THIRD PARTY; (B) MISTAKES, OMISSIONS, INTERRUPTIONS, ERRORS, FAILURES TO TRANSMIT, DELAYS, OR DEFECTS IN THE SERVICE PROVIDED BY OR THROUGH THE UNDERLYING CARRIER; (C) DAMAGE OR INJURY CAUSED BY SUSPENSION OR TERMINATION BY THE UNDERLYING CARRIER; OR (D) DAMAGE OR INJURY CAUSED BY A FAILURE OR DELAY IN CONNECTING A CALL TO ANY ENTITY, INCLUDING 911 OR ANY OTHER EMERGENCY SERVICE. TO THE FULL EXTENT ALLOWED BY LAW, THE END USER RELEASES, INDEMNIFIES AND HOLDS THE UNDERLYING CARRIER HARMLESS FROM AND AGAINST ANY AND ALL CLAIMS OF ANY PERSON OR ENTITY FOR DAMAGES OF ANY NATURE ARISING IN ANY WAY FROM OR RELATING TO, DIRECTLY OR INDIRECTLY, SERVICES PROVIDED BY THE UNDERLYING CARRIER OR ANY PERSON'S USE THEREOF, INCLUDING CLAIMS ARISING IN WHOLE OR IN PART FROM THE ALLEGED NEGLIGENCE OF THE UNDERLYING CARRIER.

VII. China Territory

Personal Use Only

You agree to use this Data together with [insert name of Client Application] for the solely personal, non-commercial purposes for which you were licensed, and not for service bureau, time-sharing or other similar purposes. Accordingly, but subject to the restrictions set forth in the following paragraphs, you may copy this Data only as necessary for your personal use to (i)

view it, and (ii) save it, provided that you do not remove any copyright notices that appear and do not modify the Data in any way. You agree not to otherwise reproduce, copy, modify, decompile, disassemble or reverse engineer any portion of this Data, and may not transfer or distribute it in any form, for any purpose, except to the extent permitted by mandatory laws.

Restrictions

Except where you have been specifically licensed to do so by NAV2, and without limiting the preceding paragraph, you may not (a) use this Data with any products, systems, or applications installed or otherwise connected to or in communication with vehicles, capable of vehicle navigation, positioning, dispatch, real time route guidance, fleet management or similar applications; or (b) with or in communication with any positioning devices or any mobile or wireless-connected electronic or computer devices, including without limitation cellular phones, palmtop and handheld computers, pagers, and personal digital assistants or PDAs. You agree to cease using this Data if you fail to comply with these terms and conditions.

Limited Warranty

NAV2 warrants that (a) the Data will perform substantially in accordance with the accompanying written materials for a period of ninety (90) days from the date of receipt, and (b) any support services provided by NAV2 shall be substantially as described in applicable written materials provided to you by NAV2, and NAV2's support engineers will make commercially reasonable efforts to solve any problem issues.

Appendices

Customer Remedies

NAV2 and its suppliers' entire liability and your exclusive remedy shall be, at NAV2's sole discretion, either (a) return of the price paid, if any, or (b) repair or replacement of the Data that do not meet NAV2's Limited Warranty and that are returned to NAV2 with a copy of your receipt. This Limited Warranty is void if failure of the Data has resulted from accident, abuse, or misapplication. Any replacement Data will be warranted for the remainder of the original warranty period or thirty (30) days, whichever is longer. Neither these remedies nor any product support services offered by NAV2 are available without proof of purchase from an authorized international source.

No Other Warranty:

EXCEPT FOR THE LIMITED WARRANTY SET FORTH ABOVE AND TO THE EXTENT PERMITTED BY APPLICABLE LAW, NAV2 AND ITS LICENSORS (INCLUDING THEIR LICENSORS AND SUPPLIERS) DISCLAIM ANY WARRANTIES, EXPRESS OR IMPLIED, OF QUALITY, PERFORMANCE, MERCHANTABILITY, FITNESS FOR A PARTICULAR PURPOSE, OWNERSHIP OR NON-INFRINGEMENT. Certain warranty exclusions may not be permitted under applicable law, so to that extent the above exclusion may not apply to you.

Limited Liability:

TO THE EXTENT PERMITTED BY APPLICABLE LAW, NAV2 AND ITS LICENSORS (INCLUDING THEIR LICENSORS AND SUPPLIERS) SHALL NOT BE LIABLE TO YOU: IN RESPECT OF ANY CLAIM, DEMAND OR ACTION, IRRESPECTIVE OF THE NATURE OF THE CAUSE OF THE CLAIM, DEMAND OR ACTION ALLEGING ANY LOSS, INJURY OR DAMAGES, DIRECT OR INDIRECT, WHICH MAY RESULT FROM THE USE OR POSSESSION OF THE INFORMATION; OR

FOR ANY LOSS OF PROFIT, REVENUE, CONTRACTS OR SAVINGS, OR ANY OTHER DIRECT, INDIRECT, INCIDENTAL, SPECIAL OR CONSEQUENTIAL DAMAGES ARISING OUT OF YOUR USE OF OR INABILITY TO USE THIS INFORMATION, ANY DEFECT IN THE INFORMATION, OR THE BREACH OF THESE TERMS OR CONDITIONS, WHETHER IN AN ACTION IN CONTRACT OR TORT OR BASED ON A WARRANTY, EVEN IF NAV2 OR ITS LICENSORS HAVE BEEN ADVISED OF THE POSSIBILITY OF SUCH DAMAGES. UNDER NO CIRCUMSTANCES SHALL NAV2'S OR ITS SUPPLIERS' LIABILITY HEREUNDER EXCEED THE PRICE PAID. Certain liability exclusions may not be permitted under applicable law, so to that extent the above exclusion may not apply to you.

Export Control

You agree not to export to anywhere any part of the Data provided to you or any direct product thereof except in compliance with, and with all licenses and approvals required under, applicable export laws, rules and regulations.

IP Protection

The Data are owned by NAV2 or its suppliers and are protected by applicable copyright and other intellectual property law and treaties. The Data are provided solely on the basis of a license to use, not sale.

Entire Agreement

These terms and conditions constitute the entire agreement between NAV2 (and its licensors, including their licensors and suppliers) and you pertaining to the subject matter hereof, and supersedes in their entirety any and all written or oral agreements previously existing between us with respect to such subject matter.

Appendices

Governing Law.

The above terms and conditions shall be governed by the laws of the People's Republic of China, without giving effect to (i) its conflict of laws provisions, or (ii) the United Nations Convention for Contracts for the International Sale of Goods, which is explicitly excluded. Any dispute arising from or in connection with the Data provided to you hereunder shall be submitted to the Shanghai International Economic and Trade Arbitration Commission for arbitration.

Gracenote® Copyright

CD and music-related data from Gracenote, Inc., copyright©

2000-2007 Gracenote. Gracenote Software, copyright © 2000-2007 Gracenote. This product and service may practice one or more of the following U.S. Patents 5,987,525; 6,061,680; 6,154,773; 6,161,132; 6,230,192; 6,230,207; 6,240,459; 6,330,593 and other patents issued or pending. Some services supplied under license from Open Globe, Inc. for U.S. Patent 6,304,523.

Gracenote and CDDB are registered trademarks of Gracenote. The Gracenote logo and logotype, and the "Powered by Gracenote™" logo are trademarks of Gracenote.

Gracenote® End User License Agreement (EULA)

This device contains software from Gracenote, Inc. of 2000 Powell Street Emeryville, California 94608 ("Gracenote").

The software from Gracenote (the "Gracenote Software") enables this device to do disc and music file identification and obtain music-related information, including name, artist, track, and title information ("Gracenote Data") from online servers

("Gracenote Servers"), and to perform other functions. You may use Gracenote Data only by means of the intended End User functions of this device. This device may contain content belonging to Gracenote's providers. If so, all of the restrictions set forth herein with respect to Gracenote Data shall also apply to such content and such content providers shall be entitled to all of the benefits and protections set forth herein that are available to Gracenote. You agree that you will use the content from Gracenote ("Gracenote Content"), Gracenote Data, the Gracenote Software, and Gracenote Servers for your own personal, non-commercial use only. You agree not to assign, copy, transfer or transmit the Gracenote Content, Gracenote Software or any Gracenote Data (except in a Tag associated with a music file) to any third party. YOU AGREE NOT TO USE OR EXPLOIT GRACENOTE CONTENT, GRACENOTE DATA, THE GRACENOTE SOFTWARE, OR GRACENOTE SERVERS, EXCEPT AS EXPRESSLY PERMITTED HEREIN.

You agree that your non-exclusive licenses to use the Gracenote Content, Gracenote Data, the Gracenote Software, and Gracenote Servers will terminate if you violate these restrictions. If your licenses terminate, you agree to cease any and all use of the Gracenote Content, Gracenote Data, the Gracenote Software, and Gracenote Servers.

Gracenote, respectively, reserve all rights in Gracenote Data, the Gracenote Software, and the Gracenote Servers and Gracenote Content, including all ownership rights. Under no circumstances will either Gracenote become liable for any payment to you for any information that you provide,

Appendices

including any copyrighted material or music file information. You agree that Gracenote may enforce its respective rights, collectively or separately, under this agreement against you, directly in each company's own name.

Gracenote uses a unique identifier to track queries for statistical purposes. The purpose of a randomly assigned numeric identifier is to allow Gracenote to count queries without knowing anything about who you are. For more information, see the web page at www.gracenote.com for the Gracenote Privacy Policy.

THE GRACENOTE SOFTWARE, EACH ITEM OF GRACENOTE DATA AND THE GRACENOTE CONTENT ARE LICENSED TO YOU "AS IS". NEITHER GRACENOTE MAKES ANY REPRESENTATIONS OR WARRANTIES, EXPRESS OR IMPLIED, REGARDING THE ACCURACY OF ANY GRACENOTE DATA FROM THE GRACENOTE SERVERS OR GRACENOTE CONTENT. GRACENOTE COLLECTIVELY AND SEPARATELY RESERVE THE RIGHT TO DELETE DATA AND/OR CONTENT FROM THE COMPANIES' RESPECTIVE SERVERS OR, IN THE CASE OF GRACENOTE, CHANGE DATA CATEGORIES FOR ANY CAUSE THAT GRACENOTE DEEMS SUFFICIENT. NO WARRANTY IS MADE THAT EITHER GRACENOTE CONTENT OR THE GRACENOTE SOFTWARE OR GRACENOTE SERVERS ARE ERROR-FREE OR THAT THE FUNCTIONING OF THE GRACENOTE SOFTWARE OR GRACENOTE SERVERS WILL BE UNINTERRUPTED. GRACENOTE IS NOT OBLIGATED TO PROVIDE YOU WITH ANY ENHANCED OR ADDITIONAL DATA TYPES THAT GRACENOTE MAY CHOOSE TO PROVIDE IN THE FUTURE AND IS FREE TO DISCONTINUE ITS ONLINE SERVICES AT ANY TIME. GRACENOTE DISCLAIM ALL WARRANTIES EXPRESS OR IMPLIED, INCLUDING, BUT NOT LIMITED TO,

IMPLIED WARRANTIES OF MERCHANTABILITY, FITNESS FOR A PARTICULAR PURPOSE, TITLE, AND NON-INFRINGEMENT. NEITHER GRACENOTE WARRANTS THE RESULTS THAT WILL BE OBTAINED BY YOUR USE OF THE GRACENOTE SOFTWARE OR ANY GRACENOTE SERVER. IN NO CASE WILL GRACENOTE BE LIABLE FOR ANY CONSEQUENTIAL OR INCIDENTAL DAMAGES OR FOR ANY LOST PROFITS OR LOST REVENUES FOR ANY REASON WHATSOEVER. © Gracenote 2007.

Radio Frequency Statement

FCC ID: ACJ-SYNCG3-L

IC: 216B-SYNCG3-L

This device complies with Part 15 of the FCC Rules and with RSS-210 of Industry Canada. Operation is subject to the following two conditions:

- (1)** This device may not cause harmful interference, and
- (2)** this device must accept any interference received, including interference that may cause undesired operation.



WARNING: Changes or modifications not expressly approved by the party responsible for compliance could void the user's authority to operate the equipment. The term "IC:" before the radio certification number only signifies that Industry Canada technical specifications were met.

The antenna used for this transmitter must not be co-located or operating in conjunction with any other antenna or transmitter.

Appendices

Taiwan Territory

According to the "Technical Specifications for Low Power Radio Frequency Equipment" formulated by the National Communications and Communication Committee of the Executive Yuan: 3.8.2. For the low-power radio frequency equipment that has obtained the verification certificate, the company, firm or user shall not change the frequency, increase the power or change the characteristics and functions of the original design without authorization.

The use of low-power radio frequency equipment must not affect flight safety and interfere with legal communications: when the system detects interference, immediately stop using it until there is no interference.

The aforementioned legal communication refers to the wireless communication operated in accordance with the provisions of the Telecommunications Management Law. Low-power radio frequency equipment needs to endure the interference of legal communication or industrial, scientific and medical radio wave radiation electrical equipment.

SUNA TRAFFIC CHANNEL – TERMS AND CONDITIONS

By activating, using and/or accessing the SUNA Traffic Channel, SUNA Predictive or other content or material provided by Intelematics (together, **SUNA Products and/or Services**), you must accept certain terms and conditions. The following is a brief summary of the terms and conditions that apply to you. To view the full terms and conditions relevant to your use of the SUNA Products and/or Services, please consult:

Website
www.sunatrafic.com.au/termsandconditions/

1. Acceptance

By using SUNA Products and/or Services, you will be deemed to have accepted and agreed to be bound by the terms and conditions fully detailed at:

Website
www.sunatrafic.com.au/termsandconditions/

2. Intellectual Property

SUNA Products and/or Services are for your personal use. You may not record, or retransmit the content, nor use the content in association with any other traffic information or route guidance service or device not approved by Intelematics. You obtain no right of ownership in any Intellectual Property Rights (including copyright) in the data that is used to provide SUNA Products and/or Services.

3. Appropriate Use

SUNA Products and/or Services are intended as an aid to personal motoring and travel planning, and do not provide comprehensive or accurate information on all occasions. On occasions, you may experience additional delay as a result of using SUNA Products and/or Services. You acknowledge that it is not intended, or suitable, for use in applications where time of arrival or driving directions may impact the safety of the public or yourself.

4. Use of SUNA Products and Services while driving

Appendices

You, and other authorised drivers of the vehicle in which SUNA Products and/or Services are available or installed and active, remain at all times responsible for observing all relevant laws and codes of safe driving. In particular, you agree to only actively operate SUNA Products and/or Services when the Vehicle is at a complete stop and it is safe to do so.

5. Service Continuity and Reception of the SUNA Traffic Channel

We will use reasonable endeavours to provide the SUNA Traffic Channel 24 hours a day, 365 days a year. The SUNA Traffic Channel may occasionally be unavailable for technical reasons or for planned maintenance. We will try to perform maintenance at times when congestion is light. We reserve the right to withdraw SUNA Products and/or Services at any time.

Also, we cannot assure the uninterrupted reception of the SUNA Traffic Channel RDS-TMC signal at any particular location.

6. Limitation of Liability

Neither Intelematics (nor its suppliers or the manufacturer of your device (the “**Suppliers**”)) shall be liable to you or to any third party for any damages either direct, indirect, incidental, consequential or otherwise arising out of the use of or inability to use SUNA Products and/or Services even if Intelematics or a Supplier has been advised of the possibility of such damages. You also acknowledge that the neither Intelematics nor any Supplier guarantees nor make any warranties that relate to the availability, accuracy or completeness of SUNA Products and/or Services, and to the extent which it is lawful to do so, both Intelematics and each Supplier excludes any warranties which might otherwise be implied by any State or Federal legislation in relation to SUNA Products and/or Services.

7. Please Note

Great care has been taken in preparing this manual. Constant product development may mean that some information is not entirely up-to-date. The information in this document is subject to change without notice.

Index

3

360 Degree Camera.....237

4

4WD

See: Four-Wheel Drive.....203

9

911 Assist.....55

A

A/C

See: Climate Control.....137

About This Manual.....9

ABS

See: Brakes.....210

ABS driving hints

See: Hints on Driving With Anti-Lock

Brakes.....211

Accessories.....473

Accessories

See: Replacement Parts

Recommendation.....12

Active Park Assist.....230

Adaptive Cruise Control.....241

Adaptive Cruise Control –

Troubleshooting.....250

Adaptive Cruise Control Indicators -

Vehicles With: Intelligent Adaptive

Cruise Control.....248

Adaptive Cruise Control Indicators -

Vehicles With: Lane Centering.....248

Adaptive Cruise Control Indicators -

Vehicles With: Stop and Go.....248

Adaptive Cruise Control Limitations -

Vehicles With: Lane Centering.....242

Adaptive Cruise Control Limitations -

Vehicles With: Stop and Go.....243

Adaptive Cruise Control Precautions -

Vehicles With: Lane Centering.....241

Adaptive Cruise Control Precautions -

Vehicles With: Stop and Go.....241

Adaptive Cruise Control –

Troubleshooting.....250

Adaptive Cruise Control – Information

Messages.....250

Adaptive Headlamps.....89

Adjusting the Headlamps.....335

Adjusting the Set Speed

Tolerance.....250

Adjusting the Steering Wheel - Vehicles

With: Manual Adjustable Steering

Column.....79

Adjusting the Steering Wheel - Vehicles

With: Power Adjustable Steering

Column.....79

AFS

See: Adaptive Headlamps.....89

Airbag Disposal.....53

Air Conditioning

See: Climate Control.....137

Air Filter

See: Changing the Engine Air Filter - 2.3L

EcoBoost™.....321

See: Changing the Engine Air Filter -

3.0L.....322

See: Changing the Engine Air Filter -

3.3L.....323

Alarm

See: Anti-Theft Alarm.....77

Ambient Lighting - Vehicles With: 10.1

Inch Center Display Screen.....91

Ambient Lighting - Vehicles With: 8 Inch

Center Display Screen.....90

Anti-Theft Alarm.....77

Appendices.....531

Apps.....455

At a Glance.....20

At a Glance - ST.....20

Audible Warnings and Indicators.....109

Audio Control.....81

Audio System.....419

General Information.....419

Audio Unit.....419

Auto Hold.....214

Autolamps.....87

Automatic Climate Control.....137

Automatic High Beam Control.....92

Automatic High Beam Control

Indicators.....93

Index

Automatic Transmission.....	197
Automatic Transmission Fluid Check.....	328
Auto-Start-Stop.....	176
Autowipers.....	83
Auxiliary Power Points.....	164

B

Battery See: Changing the 12V Battery - Excluding: Hybrid Electric Vehicle (HEV).....	329
See: Changing the 12V Battery - Hybrid Electric Vehicle (HEV).....	332
Blind Spot Information System.....	259
BLIS See: Blind Spot Information System.....	259
Body Styling Kits.....	346
Bonnet Lock See: Opening and Closing the Hood.....	315
Booster Seats.....	33
Brake Fluid Check.....	328
Brakes.....	210
General Information.....	210
Breaking-In.....	288
Bulb Specification Chart.....	412

C

Canceling the Set Speed.....	240
Capacities and Specifications - 2.3L EcoBoost™.....	384
Capacities and Specifications - 3.0L.....	391
Capacities and Specifications - 3.3L, Gasoline.....	398
Capacities and Specifications - 3.3L, Hybrid Electric Vehicle (HEV).....	405
Capacities and Specifications.....	378
Cargo Nets.....	276
Car Wash See: Cleaning the Exterior.....	340
Catalytic Converter.....	193
Changing a Bulb.....	337
Changing a Fuse.....	313
Changing a Road Wheel.....	370
Changing the 12V Battery - Excluding: Hybrid Electric Vehicle (HEV).....	329

Changing the 12V Battery - Hybrid Electric Vehicle (HEV).....	332
Changing the Engine Air Filter - 2.3L EcoBoost™.....	321
Changing the Engine Air Filter - 3.0L.....	322
Changing the Engine Air Filter - 3.3L.....	323
Changing the Front Wiper Blades.....	336
Changing the Rear Wiper Blades.....	337
Changing the Vehicle Wi-Fi Hotspot Name or Password.....	418
Charging a Wireless Device.....	166
Checking MyKey System Status.....	66
Checking the Wiper Blades.....	336
Child Restraint and Seatbelt Maintenance.....	43
Child Restraint Positioning.....	35
Child Safety.....	23
General Information.....	23
Child Safety Locks.....	36
Cleaning Leather Seats.....	343
Cleaning Products.....	339
Cleaning the Engine.....	341
Cleaning the Exterior.....	340
Cleaning the Instrument Panel and Instrument Cluster Lens.....	343
Cleaning the Interior.....	342
Cleaning the Wheels.....	344
Cleaning the Windows and Wiper Blades.....	342
Clearing All MyKeys.....	66
Clearing the Garage Door Opener.....	162
Climate.....	445
Climate Control.....	137
Cold Weather Precautions.....	288
Collision, Damage or Fire Event.....	295
Connected Vehicle.....	414
Connecting the Vehicle to a Mobile Network.....	414
Connected Vehicle Data.....	17
Connected Vehicle Limitations.....	414
Connected Vehicle Requirements.....	414
Connected Vehicle – Troubleshooting - Vehicles With: Modem.....	415
Connected Vehicle – Troubleshooting - Vehicles With: SYNC 3.....	416

Index

Connecting the Vehicle to a Mobile Network.....	414
Connecting FordPass to the Modem.....	414
Enabling and Disabling the Modem.....	414
What Is the Modem.....	414
Connecting the Vehicle to a Wi-Fi Network - Vehicles With: SYNC 3.....	414
Coolant Check	
See: Engine Coolant Check.....	324
Crash Sensors and Airbag Indicator.....	52
Creating a MyKey.....	65
Creating a Vehicle Wi-Fi Hotspot.....	418
Cross Traffic Alert.....	263
Cruise Control.....	239
Cruise Control Indicators.....	240
Cruise Control - Vehicles With: Cruise Control.....	81
Cruise Control - Vehicles With: Stop and Go.....	82
Cup Holders.....	167
Customer Assistance.....	298
Customer Information.....	485
Radio Frequency Certification Labels.....	485
D	
Data Privacy.....	15
Daytime Running Lamps - Vehicles With: Configurable Daytime Running Lamps.....	88
Daytime Running Lamps - Vehicles With: Daytime Running Lamps (DRL).....	88
Digital Radio.....	420
Direction Indicators.....	89
Doors and Locks.....	68
Drive Mode Control.....	273
Drive Modes.....	273
Drive Modes.....	273
Deep Snow/Sand.....	273
Eco.....	274
Normal.....	274
Slippery.....	274
Sport.....	274
Tow/Haul.....	274
Trail.....	274
Driver Alert.....	254
Driver and Passenger Airbags.....	47
Driver and Passenger Knee Airbags.....	51
Driving Aids.....	254
Driving Economically.....	288
Driving Hints.....	288
Driving Through Shallow Water.....	289
DRL	
See: Daytime Running Lamps - Vehicles With: Configurable Daytime Running Lamps.....	88
See: Daytime Running Lamps - Vehicles With: Daytime Running Lamps (DRL).....	88
E	
Electric Parking Brake.....	211
Electric Vehicle Information.....	454
Electromagnetic Compatibility.....	531
Emergency Call Limitations.....	56
Emergency Call Requirements.....	55
Emergency Call System Data.....	18
Emission Law.....	192
End User License Agreement.....	534
Engine Block Heater.....	174
Engine Coolant Check.....	324
Engine Emission Control.....	192
Engine Immobilizer	
See: Passive Anti-Theft System.....	77
Engine Oil Check.....	319
Engine Oil Dipstick - 2.3L EcoBoost™.....	319
Engine Oil Dipstick - 3.0L.....	319
Engine Oil Dipstick - 3.3L.....	319
Engine Specifications - 2.3L EcoBoost™.....	378
Engine Specifications - 3.0L, ST.....	378
Engine Specifications - 3.0L.....	380
Engine Specifications - 3.3L, Gasoline.....	380
Engine Specifications - 3.3L, Hybrid Electric Vehicle (HEV).....	381
Entertainment.....	435
Environment.....	19
EPB	
See: Electric Parking Brake.....	211
Essential Towing Checks.....	285
Event Data.....	16
Export Unique Options.....	14
Exterior Mirrors - Excluding: ST.....	95

Index

Exterior Mirrors - ST.....96

F

Fastening the Seatbelts.....39

Flat Tire

See: Changing a Road Wheel.....370

Floor Mats.....289

Fog Lamps - Front

See: Front Fog Lamps.....88

Ford Credit.....12

Ford Protect.....474

Four-Wheel Drive.....203

Principle of Operation.....203

Front Fog Lamps.....88

Front Parking Aid.....227

Front Passenger Sensing System.....48

Front Wiper Blades

See: Changing the Front Wiper Blades.....336

Fuel and Refueling.....181

Fuel Consumption.....191

Fuel Filler Funnel Location.....183

Fuel Filter.....336

Fuel Quality - E85.....181

Fuel Quality - Gasoline.....183

Fuel Shutoff.....292

Fuses.....305

Fuse Specification Chart.....305

G

Garage Door Opener.....160

Garage Door Opener Limitations.....160

Garage Door Opener Precautions.....160

Garage Door Opener Radio

Frequencies.....163

Gauges - Vehicles With: 12.3 Inch

Instrument Cluster Display

Screen.....102

Gauges - Vehicles With: 4.2 Inch

Instrument Cluster Display

Screen.....104

Gauges - Vehicles With: 6.5 Inch

Instrument Cluster Display

Screen.....101

Gearbox

See: Transmission.....197

General Information on Radio

Frequencies.....57

General Maintenance Information.....476

Getting Assistance Outside the U.S. and

Canada.....301

Getting the Services You Need.....298

Global Opening.....95

H

Hazard Flashers.....292

Headlamp Adjusting

See: Adjusting the Headlamps.....335

Headlamp Exit Delay.....87

Headrest

See: Head Restraints.....144

Head Restraints.....144

Heated Exterior Mirrors.....142

Heated Rear Window.....142

Heated Seats.....156

Heated Steering Wheel.....82

Heated Windshield.....141

Heating

See: Climate Control.....137

High Voltage Battery.....196

General Information - Hybrid Electric

Vehicle (HEV).....196

Hill Descent Control.....224

Hill Descent Control Indicator.....224

Hill Start Assist.....213

Hints on Controlling the Interior

Climate.....139

Hints on Driving With Anti-Lock

Brakes.....211

Hood Lock

See: Opening and Closing the Hood.....315

Horn.....82

How Does 911 Assist Work.....55

How Does Adaptive Cruise Control With

Stop and Go Work.....241

How Does Drive Mode Control

Work.....273

How Does the Garage Door Opener

Work.....160

How Does the Rear Occupant Alert

System Work.....158

Index

Hybrid Vehicle Frequently Asked Questions - Hybrid Electric Vehicle (HEV).....	180
Hybrid Vehicle Operation - Hybrid Electric Vehicle (HEV).....	178
I	
Ignition Switch.....	168
In California (U.S. Only).....	299
Information Display Control.....	82
Information Displays.....	110
General Information - Vehicles With: 12.3 Inch Instrument Cluster Display Screen.....	112
General Information - Vehicles With: 4.2 Inch Instrument Cluster Display Screen.....	115
General Information - Vehicles With: 6.5 Inch Instrument Cluster Display Screen.....	110
Information Messages.....	119
Installing Child Restraints.....	25
Instrument Cluster.....	101
Instrument Lighting Dimmer.....	87
Instrument Panel.....	21
Interior Air Quality.....	143
Interior Lamps.....	90
Interior Mirror.....	98
Introduction.....	9
J	
Jump Starting the Vehicle.....	293
K	
Keyless Entry.....	71
Keyless Starting.....	169
Keys and Remote Controls.....	57
L	
Lane Keeping System.....	255
Liftgate.....	73
Lighting Control.....	86
Lighting.....	86
General Information.....	86
Limited Slip Differential.....	209
Load Carriers See: Roof Racks and Load Carriers.....	276
Load Carrying.....	275
General Information.....	275
Load Limit.....	277
Locating the Wireless Accessory Charger.....	166
Locking and Unlocking.....	68
Lug Nuts See: Changing a Road Wheel.....	370
M	
Maintenance.....	315
General Information.....	315
Manual Seats.....	146
Memory Function.....	150
Message Center See: Information Displays.....	110
Mirrors See: Windows and Mirrors.....	94
Mobile Communications Equipment.....	14
Mobile Device Data.....	18
Moonroof.....	99
Motorcraft Parts - 2.3L EcoBoost™.....	382
Motorcraft Parts - 3.0L.....	382
Motorcraft Parts - 3.3L.....	383
MyKey – Troubleshooting.....	67
MyKey™.....	64
Principle of Operation.....	64
N	
Navigation.....	449
Normal Scheduled Maintenance.....	479
O	
Oil Change Indicator Reset.....	320
Oil Check See: Engine Oil Check.....	319
Opening and Closing the Hood.....	315
Ordering Additional Owner's Literature.....	303
Overhead Console.....	167

Index

Overriding Automatic High Beam Control.....	93
Overriding Reverse Braking Assist.....	217
Overriding the Set Speed.....	247
P	
Parking Aids.....	225
Principle of Operation.....	225
Passive Anti-Theft System.....	77
PATS	
See: Passive Anti-Theft System.....	77
Pedestrian Alert System.....	54
Pedestrian Protection.....	54
Perchlorate.....	12
Personalized Settings.....	117
Personal Safety System™.....	45
Phone.....	447
Post-Crash Alert System.....	296
Power Door Locks	
See: Locking and Unlocking.....	68
Power Liftgate.....	73
Power Seats.....	147
Power Steering Fluid Check.....	329
Power Windows.....	94
Pre-Collision Assist.....	268
Programming the Garage Door Opener to Your Garage Door Opener Motor.....	161
Programming the Garage Door Opener to Your Gate Opener Motor.....	162
Programming the Garage Door Opener to Your Hand-Held Transmitter.....	161
Protecting the Environment.....	19
Puncture	
See: Changing a Road Wheel.....	370
R	
Radio Frequency Certification Labels.....	485
Blind Spot Information System Sensors.....	485
Body Control Module.....	491
Cruise Control Module.....	494
Garage Door Opener.....	497
Keys and Remote Controls.....	498
Passive Anti-Theft System.....	505
Radio Transceiver Module.....	509
SYNC.....	511
Telematics Control Unit.....	516
Tire Pressure Monitoring System Sensors.....	516
Wireless Accessory Charging Module.....	523
Rear Axle.....	209
Rear Occupant Alert System Audible Warnings.....	159
Rear Occupant Alert System Indicators.....	159
Rear Occupant Alert System Limitations.....	158
Rear Occupant Alert System Precautions.....	158
Rear Occupant Alert System.....	158
Rear Parking Aid.....	225
Rear Passenger Climate Controls.....	140
Rear Seats.....	151
Rear Under Floor Storage.....	275
Rear View Camera.....	234
Rear View Camera	
See: Rear View Camera.....	234
Rear Window Wiper and Washers.....	85
Rear Wiper Blades	
See: Changing the Rear Wiper Blades.....	337
Recommended Towing Weights.....	284
Reduced Engine Performance.....	288
Refueling - Excluding: Hybrid Electric Vehicle (HEV).....	185
Refueling - Hybrid Electric Vehicle (HEV).....	188
Remote Control.....	57
Remote Start.....	142
Repairing Minor Paint Damage.....	344
Replacement Parts	
Recommendation.....	12
Replacing a Lost Key or Remote Control.....	63
Replacing the Cabin Air Filter.....	143
Reporting Safety Defects (Canada Only).....	303
Reporting Safety Defects (U.S. Only).....	303
Reprogramming the Garage Door Opener.....	163
Resuming the Set Speed.....	240
Reverse Braking Assist Indicators.....	217

Index

Reverse Braking Assist	
Precautions.....	216
Reverse Braking Assist.....	216
Reverse Braking Assist –	
Troubleshooting.....	218
Reverse Braking Assist –	
Troubleshooting.....	218
Reverse Braking Assist – Frequently Asked	
Questions.....	219
Reverse Braking Assist – Information	
Messages.....	218
Roadside Assistance.....	291
Roadside Emergencies.....	291
Rollover Warning.....	485
Roof Racks and Load Carriers.....	276
Running-In	
See: Breaking-In.....	288
Running Out of Fuel.....	183
S	
Safety Canopy™.....	51
Safety Precautions.....	181
Satellite Radio.....	422
Scheduled Maintenance.....	476
Seatbelt Extensions.....	44
Seatbelt Height Adjustment.....	41
Seatbelt Reminder.....	42
Seatbelts.....	38
Principle of Operation.....	38
Seatbelt Warning Lamp and Indicator	
Chime.....	41
Seats.....	144
Security.....	77
Selecting a Drive Mode.....	273
Service Data.....	16
Settings Data.....	17
Settings.....	458
Setting the Adaptive Cruise Control	
Gap.....	246
Setting the Adaptive Cruise Control	
Speed.....	245
Setting the Cruise Control Speed.....	239
Setting the Hill Descent Speed.....	224
Side Airbags.....	50
Side Sensing System.....	229
Sitting in the Correct Position.....	144
Snow Chains	
See: Using Snow Chains.....	363
Spare Wheel	
See: Changing a Road Wheel.....	370
Special Notices.....	13
Special Operating Conditions Scheduled	
Maintenance.....	482
Speed Control	
See: Cruise Control.....	239
Speed Sign Recognition.....	266
Stability Control.....	221
Principle of Operation.....	221
Starter Switch	
See: Ignition Switch.....	168
Starting a Gasoline Engine.....	169
Starting a Hybrid Electric Vehicle	
System.....	172
Starting and Stopping the Engine.....	168
General Information.....	168
Steering.....	268
Steering Wheel.....	79
Storage Compartments.....	167
Sunroof	
See: Moonroof.....	99
Sun Shades.....	99
Sun Visors.....	98
Supplementary Restraints System.....	46
Principle of Operation.....	46
Switching Adaptive Cruise Control On	
and Off.....	245
Switching Automatic High Beam Control	
On and Off.....	92
Switching Cruise Control On and	
Off.....	239
Switching From Adaptive Cruise Control	
to Cruise Control.....	248
Switching Hill Descent Control On and	
Off.....	224
Switching Intelligent Mode On and	
Off.....	250
Switching Lane Centering On and	
Off.....	249
Switching Rear Occupant Alert System	
On and Off.....	158
Switching Reverse Braking Assist On and	
Off.....	217
Symbols Glossary.....	9

Index

SYNC™ 3.....	427
General Information.....	427
SYNC™ 3 Troubleshooting.....	460

T

Technical Specifications	
See: Capacities and Specifications.....	378
The Better Business Bureau (BBB) Auto Line Program (U.S. Only).....	300
Tire Care.....	349
Tire Pressure Monitoring System.....	364
Tires	
See: Wheels and Tires.....	347
Towing a Trailer.....	283
Towing the Vehicle on Four	
Wheels.....	287
Towing.....	283
Traction Control.....	220
Principle of Operation.....	220
Trailer Sway Control.....	284
Transmission.....	197
Transporting the Vehicle.....	296

U

Under Hood Overview - 2.3L	
EcoBoost™.....	316
Under Hood Overview - 3.0L.....	317
Under Hood Overview - 3.3L.....	318
Unique Driving Characteristics.....	176
USB Port.....	425
Using Four-Wheel Drive.....	203
Using MyKey With Remote Start	
Systems.....	67
Using Snow Chains.....	363
Using Stability Control.....	222
Using Summer Tires.....	362
Using Traction Control.....	220
Using Voice Recognition.....	429
Using Winter Tires.....	362
Utilizing the Mediation/Arbitration Program (Canada Only).....	301

V

Vehicle Care.....	339
General Information.....	339

Vehicle Identification Number.....	383
Vehicle Storage.....	344
Vehicle Wi-Fi Hotspot.....	418
Ventilated Seats.....	157
Ventilation	
See: Climate Control.....	137
VIN	
See: Vehicle Identification Number.....	383
Voice Control.....	81

W

Warning Lamps and Indicators.....	105
Warranty Information.....	529
Washer Fluid Check.....	336
Washers	
See: Cleaning the Exterior.....	340
See: Wipers and Washers.....	83
Waxing.....	341
What Is 911 Assist.....	55
What Is a Connected Vehicle.....	414
What Is Adaptive Cruise Control With Lane Centering.....	241
What Is Automatic High Beam Control.....	92
What Is Cruise Control.....	239
What Is Drive Mode Control.....	273
What Is Hill Descent Control.....	224
What Is Intelligent Adaptive Cruise Control.....	241
What Is Reverse Braking Assist.....	216
What Is the Cabin Air Filter.....	143
What Is the Garage Door Opener.....	160
What is the Rear Occupant Alert System.....	158
What Is the Wireless Accessory Charger.....	166
Wheel Nuts	
See: Changing a Road Wheel.....	370
Wheels and Tires.....	347
General Information.....	347
Technical Specifications.....	376

Index

Wi Fi	
See: Changing the Vehicle Wi-Fi Hotspot	
Name or Password.....	418
See: Connecting the Vehicle to a Wi-Fi	
Network - Vehicles With: SYNC 3.....	414
See: Creating a Vehicle Wi-Fi Hotspot.....	418
See: Vehicle Wi-Fi Hotspot.....	418
Windows and Mirrors.....	94
Windshield Washers.....	84
Windshield Wipers.....	83
Winter Tires	
See: Using Winter Tires.....	362
Wiper Blades	
See: Checking the Wiper Blades.....	336
Wipers and Washers.....	83
Wireless Accessory Charger	
Precautions.....	166
Wireless Accessory Charger.....	166