

2022 FORD F-150 Owner's Manual



The information contained in this publication was correct at the time of going to print. In the interest of continuous development, we reserve the right to change specifications, design or equipment at any time without notice or obligation. No part of this publication may be reproduced, transmitted, stored in a retrieval system or translated into any language in any form by any means without our written permission. Errors and omissions excepted.

© Ford Motor Company 2021

All rights reserved.

Part Number: 202109 20210915162032

California Proposition 65



WARNING: Operating, servicing and maintaining a passenger vehicle or off-highway motor vehicle can expose you to chemicals including engine exhaust, carbon monoxide, phthalates, and lead, which are known to the State of California to cause cancer and birth defects or other reproductive harm. To minimize exposure, avoid breathing exhaust, do not idle the engine except as necessary, service your vehicle in a well-ventilated area and wear gloves or wash your hands frequently when servicing your vehicle. For more information go to www.P65Warnings.ca.gov/passenger-vehicle.



WARNING: Battery posts, terminals and related accessories contain lead and lead compounds, chemicals known to the State of California to cause cancer and reproductive harm.
Wash your hands after handling.

Table of Contents

About Us - Raptor

| | |
|------------------------|----|
| SVT | 19 |
| Team RS | 19 |
| Ford Performance | 19 |

Contacting Us

| | |
|---------------------|----|
| Contacting Us | 20 |
|---------------------|----|

Introduction

| | |
|------------------------------|----|
| About This Publication | 22 |
| Using This Publication | 23 |

Symbols Glossary

| | |
|------------------------------------|----|
| Symbols Used on Your Vehicle | 24 |
|------------------------------------|----|

Data Privacy

| | |
|----------------------------------|----|
| Data Privacy | 27 |
| Service Data | 28 |
| Event Data | 28 |
| Settings Data | 29 |
| Connected Vehicle Data | 29 |
| Mobile Device Data | 30 |
| Emergency Call System Data | 30 |

At a Glance - Raptor

| | |
|-----------------------|----|
| Unique Features | 31 |
|-----------------------|----|

Visual Search

| | |
|---|----|
| Steering Wheel | 32 |
| Steering Wheel - Raptor | 33 |
| Steering Wheel - Police Responder | 34 |
| Instrument Panel | 35 |
| Instrument Panel - Raptor | 36 |
| Instrument Panel - Police Responder | 37 |
| Vehicle Interior | 38 |
| Vehicle Interior - Raptor | 39 |
| Vehicle Interior - Police Responder | 40 |
| Front Exterior | 41 |

| | |
|---|----|
| Front Exterior - Raptor | 42 |
| Front Exterior - Police Responder | 43 |
| Rear Exterior | 44 |
| Rear Exterior - Raptor | 45 |
| Rear Exterior - Police Responder | 46 |

Child Safety

| | |
|-------------------------------------|----|
| Child Safety Precautions | 47 |
| Child Restraint Anchor Points | 48 |
| Child Restraints | 50 |
| Installing Child Restraints | 51 |
| Booster Seats | 58 |
| Child Safety Locks | 60 |

Seatbelts

| | |
|--|----|
| Seatbelt Precautions | 61 |
| Fastening and Unfastening the Seatbelts | 62 |
| Sensitive Locking Mode | 63 |
| Automatic Locking Mode | 63 |
| Adjusting the Seatbelts During Pregnancy | 64 |
| Adjusting the Seatbelt Height | 64 |
| Adjusting the Seatbelt Length | 65 |
| Seatbelt Reminder | 65 |
| Checking the Seatbelts | 67 |
| Seatbelt Extensions | 68 |

Personal Safety System™

| | |
|--|----|
| What Is the Personal Safety System | 69 |
| How Does the Personal Safety System Work | 69 |
| Personal Safety System Components | 69 |

Airbags

| | |
|-------------------------------------|----|
| How Do the Front Airbags Work | 70 |
| How Do the Side Airbags Work | 70 |
| How Do the Knee Airbags Work | 71 |

Table of Contents

| | |
|---|----|
| How Does the Safety Canopy™ Work | 71 |
| Airbag Precautions | 72 |
| Properly Adjusting the Driver and Front Passenger Seats | 73 |
| Children and Airbags | 73 |
| Front Passenger Sensing System | 74 |
| Crash Sensors and Airbag Indicator | 77 |
| Crash Sensors and Airbag Indicator - Police Responder | 78 |
| Disposing of Airbags | 83 |

Pedestrian Alert System

| | |
|---|----|
| What Is the Pedestrian Alert System | 84 |
|---|----|

911 Assist

| | |
|-----------------------------------|----|
| What Is 911 Assist | 85 |
| How Does 911 Assist Work | 85 |
| Emergency Call Requirements | 85 |
| Emergency Call Limitations | 86 |

Keys and Remote Controls

| | |
|--|----|
| Remote Control Limitations | 87 |
| Using the Remote Control - Police Responder | 87 |
| Using the Remote Control | 88 |
| Opening and Closing the Flip Key | 88 |
| Removing the Key Blade | 89 |
| Sounding the Panic Alarm | 89 |
| Locating Your Vehicle | 89 |
| Changing the Remote Control Battery - Police Responder | 89 |
| Changing the Remote Control Battery - Vehicles With: Push Button Start | 90 |
| Changing the Remote Control Battery - Vehicles With: Flip Key | 92 |
| Replacing a Lost Key or Remote Control | 93 |
| Programming the Remote Control - Vehicles With: Push Button Start | 93 |

| | |
|--|----|
| Programming the Remote Control - Vehicles With: Flip Key | 94 |
| Keys and Remote Controls - Troubleshooting | 95 |

MyKey™

| | |
|---|----|
| What Is MyKey | 96 |
| MyKey Settings | 96 |
| Creating a MyKey - Vehicles With: Push Button Start | 97 |
| Creating a MyKey - Vehicles With: Flip Key | 98 |
| Programming a MyKey | 98 |
| Clearing All MyKeys | 98 |
| Checking MyKey System Status | 98 |
| Using MyKey With Remote Start Systems | 98 |
| MyKey - Troubleshooting | 99 |

Doors and Locks

| | |
|---|-----|
| Operating the Doors From Outside Your Vehicle | 102 |
| Operating the Doors From Inside Your Vehicle | 102 |
| Autounlock | 103 |
| Autolock | 103 |
| Mislock | 103 |
| Doors and Locks Audible Warnings | 103 |
| Doors and Locks - Troubleshooting | 104 |

Keyless Entry

| | |
|---------------------------------------|-----|
| Keyless Entry Limitations | 106 |
| Keyless Entry Settings | 106 |
| Using Keyless Entry | 106 |
| Keyless Entry - Troubleshooting | 107 |

Keyless Entry Keypad

| | |
|---|-----|
| What Is the Keyless Entry Keypad | 108 |
| Keyless Entry Keypad Limitations | 108 |
| Locating the Keyless Entry Keypad | 108 |

Table of Contents

| | |
|--|-----|
| Keyless Entry Keypad Master Access Code | 108 |
| Keyless Entry Keypad Personal Access Codes | 108 |
| Using the Keyless Entry Keypad | 109 |
| Keyless Entry Keypad – Troubleshooting | 109 |

Easy Entry and Exit

| | |
|--|-----|
| How Does Easy Entry and Exit Work | 110 |
| Switching Easy Entry and Exit On and Off | 110 |

Tailgate - Vehicles With: Manual Tailgate

| | |
|--|-----|
| Tailgate Precautions | 111 |
| Opening the Tailgate | 111 |
| Locking and Unlocking the Tailgate | 111 |
| Removing and Installing the Tailgate | 111 |
| Tailgate Step | 112 |
| Bed Extender | 113 |
| Tailgate Work Surface | 115 |

Tailgate - Vehicles With: Power Tailgate

| | |
|--|-----|
| Tailgate Precautions | 117 |
| Opening the Tailgate | 117 |
| Closing the Tailgate | 117 |
| Removing and Installing the Tailgate | 118 |
| Tailgate Step | 119 |
| Bed Extender | 120 |
| Tailgate Work Surface | 122 |
| Tailgate – Troubleshooting | 123 |

Tailgate - Vehicles With: Remote Release Tailgate

| | |
|----------------------------|-----|
| Tailgate Precautions | 125 |
| Opening the Tailgate | 125 |

| | |
|--|-----|
| Removing and Installing the Tailgate | 125 |
| Tailgate Step | 126 |
| Bed Extender | 127 |
| Tailgate Work Surface | 129 |
| Tailgate – Troubleshooting | 130 |

Security

| | |
|--|-----|
| Passive Anti-Theft System | 132 |
| Anti-Theft Alarm System | 132 |
| Anti-Theft Alarm System Settings | 133 |
| Security – Troubleshooting | 134 |

Power Running Boards

| | |
|--|-----|
| Power Running Board Precautions | 136 |
| Power Running Board Settings | 136 |
| Power Running Board Kick Switch | 136 |
| Deploying and Stowing the Power Running Boards | 137 |
| Power Running Boards – Troubleshooting | 137 |

Steering Wheel

| | |
|---|-----|
| Adjusting the Steering Wheel - Vehicles With: Power Adjustable Steering Column | 138 |
| Adjusting the Steering Wheel - Vehicles With: Manual Adjustable Steering Column | 138 |
| Resetting the Stopping Position - Vehicles With: Power Adjustable Steering Column | 139 |
| Horn | 139 |
| Switching the Heated Steering Wheel On and Off - Vehicles With: Heated Steering Wheel | 139 |

Adjustable Pedals

| | |
|----------------------------|-----|
| Adjusting the Pedals | 140 |
|----------------------------|-----|

Wipers and Washers

| | |
|--------------|-----|
| Wipers | 141 |
|--------------|-----|

Table of Contents

| | |
|--|-----|
| Autowipers | 141 |
| Checking the Wiper Blades | 142 |
| Replacing the Front Wiper Blades | 142 |
| Washers | 143 |
| Wipers and Washers – Troubleshooting | 143 |

Exterior Lighting

| | |
|---|-----|
| Exterior Lighting Control | 145 |
| Exterior Lighting Control - Police Responder | 145 |
| Headlamps | 145 |
| Headlamps – Troubleshooting | 146 |
| Autolamps | 146 |
| Exterior Lamps | 147 |
| Exterior Zone Lighting | 149 |
| Automatic High Beam Control | 150 |
| Automatic High Beam Control – Troubleshooting | 152 |
| Glare Free Lighting | 153 |
| Glare Free Lighting – Troubleshooting | 155 |
| Adaptive Front Lighting | 155 |

Interior Lighting

| | |
|--|-----|
| Switching All of the Interior Lamps On and Off | 157 |
| Switching the Front Interior Lamps On and Off | 157 |
| Switching the Front Interior Lamps On and Off - Police Responder | 157 |
| Switching the Rear Interior Lamps On and Off | 158 |
| Interior Lamp Function | 158 |
| Adjusting the Instrument Panel Lighting Brightness | 158 |
| Ambient Lighting | 158 |
| Interior Lighting – Troubleshooting | 158 |

Windows

| | |
|---------------------------------------|-----|
| Opening and Closing the Windows | 159 |
|---------------------------------------|-----|

| | |
|---|-----|
| Window Bounce-Back | 159 |
| Locking the Rear Window Controls | 160 |
| Opening and Closing the Sliding Windows | 160 |

Interior Mirror

| | |
|--|-----|
| Interior Mirror Precautions | 161 |
| Manually Dimming the Interior Mirror | 161 |
| Auto-Dimming Interior Mirror | 161 |

Exterior Mirrors

| | |
|--|-----|
| Adjusting the Exterior Mirrors | 162 |
| Folding the Exterior Mirrors - Vehicles With: Manual Folding Mirrors | 162 |
| Folding the Exterior Mirrors - Vehicles With: Power Folding Mirrors | 162 |
| Extending the Exterior Mirrors | 163 |
| Auto-Dimming Exterior Mirror | 163 |

Moonroof

| | |
|---|-----|
| Opening and Closing the Sun Shade | 164 |
| Opening and Closing the Moonroof | 164 |
| Venting the Moonroof | 164 |
| Moonroof Bounce-Back | 165 |

Instrument Cluster

| | |
|---|-----|
| Instrument Cluster Overview - Vehicles With: 4.2 Inch Screen | 166 |
| Instrument Cluster Overview - Vehicles With: 8 Inch Screen | 167 |
| Instrument Cluster Overview - Vehicles With: 12.3 Inch Screen | 168 |
| Tachometer | 168 |
| Speedometer | 168 |
| Fuel Gauge | 168 |
| Engine Coolant Temperature Gauge | 169 |
| Engine Oil Pressure Gauge | 169 |
| Transmission Fluid Temperature Gauge | 169 |

Table of Contents

| | |
|--|-----|
| Turbo Boost Gauge | 169 |
| What Are the Instrument Cluster Warning Lamps | 169 |
| Instrument Cluster Warning Lamps | 169 |
| What Are the Instrument Cluster Indicators | 171 |
| Instrument Cluster Indicators | 171 |

Instrument Cluster Display

| | |
|---|-----|
| Using the Instrument Cluster Display Controls | 173 |
| Instrument Cluster Display Main Menu - Vehicles With: 12.3 Inch Screen | 173 |
| Instrument Cluster Display Main Menu - Raptor | 174 |
| Instrument Cluster Display Main Menu - Vehicles With: 4.2 Inch Screen | 174 |
| Instrument Cluster Display Main Menu - Vehicles With: 8 Inch Screen | 174 |
| Trip Computer - Vehicles With: 4.2 Inch Screen | 175 |
| Trip Computer - Vehicles With: 8 Inch Screen/12.3 Inch Screen | 175 |
| Customizing the Instrument Cluster Display | 175 |
| Personalized Settings | 176 |
| Hybrid Display Information | 176 |
| What Is Brake Coach | 176 |
| What Is the Trip Summary | 177 |

Remote Start

| | |
|---|-----|
| What Is Remote Start | 178 |
| Remote Start Precautions | 178 |
| Remote Start Limitations | 178 |
| Enabling Remote Start | 178 |
| Remotely Starting and Stopping the Vehicle | 178 |
| Extending the Remote Start Duration | 179 |
| Remote Start Remote Control Indicators | 179 |
| Remote Start Settings | 179 |

Climate Control - Vehicles With: Automatic Temperature Control

| | |
|--|-----|
| Identifying the Climate Control Unit | 181 |
| Switching Climate Control On and Off | 181 |
| Switching Recirculated Air On and Off | 181 |
| Switching Air Conditioning On and Off | 181 |
| Switching Defrost On and Off | 181 |
| Switching Maximum Defrost On and Off | 181 |
| Switching Maximum Cooling On and Off | 182 |
| Switching the Heated Wiper Park On and Off | 182 |
| Switching the Heated Rear Window On and Off | 182 |
| Setting the Blower Motor Speed | 182 |
| Switching the Heated Mirrors On and Off | 182 |
| Setting the Temperature | 182 |
| Directing the Flow of Air | 183 |
| Auto Mode | 183 |
| Climate Control Hints | 184 |

Climate Control - Vehicles With: Manual Temperature Control

| | |
|--|-----|
| Identifying the Climate Control Unit | 186 |
| Switching Climate Control On and Off | 186 |
| Switching Recirculated Air On and Off | 186 |
| Switching Air Conditioning On and Off | 186 |
| Switching Defrost On and Off | 186 |
| Switching Maximum Defrost On and Off | 186 |
| Switching Maximum Cooling On and Off | 187 |

Table of Contents

| | |
|---|-----|
| Switching the Heated Rear Window On and Off | 187 |
| Setting the Blower Motor Speed | 187 |
| Switching the Heated Mirrors On and Off | 187 |
| Setting the Temperature | 187 |
| Directing the Flow of Air | 187 |
| Climate Control Hints | 188 |

Interior Air Quality

| | |
|--------------------------------------|-----|
| What Is the Cabin Air Filter | 189 |
| Replacing the Cabin Air Filter | 189 |

Front Seats

| | |
|---------------------------------------|-----|
| Front Seat Precautions | 190 |
| Sitting in the Correct Position | 190 |
| Manual Seats | 191 |
| Power Seats | 193 |
| Massage Seats | 196 |
| Heated Seats | 197 |
| Ventilated Seats | 197 |

Rear Seats

| | |
|--------------------|-----|
| Manual Seats | 199 |
| Heated Seats | 200 |

Rear Occupant Alert System

| | |
|---|-----|
| What is the Rear Occupant Alert System | 202 |
| How Does the Rear Occupant Alert System Work | 202 |
| Rear Occupant Alert System Precautions | 202 |
| Rear Occupant Alert System Limitations | 202 |
| Switching Rear Occupant Alert System On and Off | 202 |
| Rear Occupant Alert System Indicators | 203 |
| Rear Occupant Alert System Audible Warnings | 203 |

Memory Function

| | |
|--|-----|
| What Is the Memory Function | 204 |
| Memory Function Precautions | 204 |
| Locating the Memory Function Buttons | 204 |
| Saving a Preset Position | 204 |
| Recalling a Preset Position | 204 |

Garage Door Opener

| | |
|---|-----|
| What Is the Garage Door Opener | 205 |
| How Does the Garage Door Opener Work | 205 |
| Garage Door Opener Precautions | 205 |
| Garage Door Opener Limitations | 205 |
| Programming the Garage Door Opener to Your Hand-Held Transmitter | 206 |
| Programming the Garage Door Opener to Your Garage Door Opener Motor | 206 |
| Programming the Garage Door Opener to Your Gate Opener Motor | 207 |
| Clearing the Garage Door Opener | 207 |
| Reprogramming the Garage Door Opener | 208 |
| Garage Door Opener Radio Frequencies | 208 |

USB Ports

| | |
|--|-----|
| Locating the USB Ports | 209 |
| Locating the USB Ports - Raptor | 209 |
| Playing Media Using the USB Port | 209 |
| Charging a Device | 210 |

Power Outlet - Vehicles With: Pickup Bed Power Generator Outlet

| | |
|---|-----|
| What Is the Power Outlet | 211 |
| Power Outlet Precautions - Vehicles With: 2kW | 211 |
| Power Outlet Precautions - Vehicles With: 2.4kW/7.2kW | 212 |
| Locating the Power Outlets | 213 |

Table of Contents

| | | | |
|---|-----|--|-----|
| Power Outlet Indicators - Vehicles With: 2kW | 213 | Wireless Accessory Charger Precautions | 226 |
| Power Outlet Indicators - Vehicles With: 2.4kW/7.2kW | 214 | Locating the Wireless Accessory Charger | 226 |
| What Is Utility Idle Mode - Vehicles With: Flip Key | 214 | Charging a Wireless Device | 226 |
| Switching Utility Idle On and Off - Vehicles With: Flip Key | 214 | Storage | |
| What Is Generator Mode | 215 | Cup Holders | 227 |
| Switching Generator Mode On and Off | 215 | Glove Compartment | 227 |
| Resetting Ground Fault Detection | 215 | Under Seat Storage | 228 |
| Resetting the Circuit Breaker - Vehicles With: 7.2kW | 216 | Glasses Holder | 230 |
| Power Outlet – Troubleshooting | 217 | Starting and Stopping the Engine | |
| Power Outlet - Vehicles With: 120V Power Outlet | | Starting and Stopping the Engine – Precautions | 231 |
| What Is the Power Outlet | 220 | Ignition Switch | 231 |
| Power Outlet Precautions | 220 | Push Button Ignition Switch | 232 |
| Power Outlet Limitations | 220 | Starting the Engine | 232 |
| Locating the Power Outlets | 220 | Engine Block Heater | 234 |
| Power Outlet Indicators | 221 | Stopping the Engine | 235 |
| Power Outlet - Vehicles With: 12V Power Outlet | | Automatic Engine Stop - Vehicles With: Keyless Entry and Push Button Start | 236 |
| What Is the Power Outlet | 222 | Accessing the Passive Key Backup Position | 237 |
| Power Outlet Precautions | 222 | Starting and Stopping the Engine – Troubleshooting | 238 |
| Locating the Power Outlets | 222 | Hybrid Electric Vehicle Information | |
| Center Console Work Surface | | What is a Hybrid Electric Vehicle | 241 |
| Using the Center Console Work Surface - Vehicles With: Column Shift | 223 | How Does a Hybrid Electric Vehicle Work | 241 |
| Using the Center Console Work Surface - Vehicles With: Console Shift | 224 | Hybrid Electric Vehicle Driving Characteristics | 241 |
| Center Console Work Surface – Troubleshooting | 225 | Hybrid Electric Vehicle Indicators | 241 |
| Wireless Accessory Charger | | Hybrid Electric Vehicle Information – Troubleshooting | 242 |
| What Is the Wireless Accessory Charger | 226 | Eco Idle | 242 |
| | | Eco Idle – Troubleshooting | 243 |

Table of Contents

Auto-Start-Stop

| | |
|--|-----|
| What Is Auto-Start-Stop | 244 |
| Auto-Start-Stop Precautions | 244 |
| Switching Auto-Start-Stop On and Off | 244 |
| Stopping the Engine | 244 |
| Restarting the Engine | 244 |
| Auto-Start-Stop Indicators | 244 |
| Auto-Start-Stop – Troubleshooting | 245 |

Fuel and Refueling

| | |
|---|-----|
| Fuel and Refueling Precautions | 247 |
| Fuel Quality | 248 |
| Locating the Fuel Filler Funnel | 250 |
| Running Out of Fuel | 250 |
| Refueling | 251 |
| Fuel Tank Capacity - Excluding: Hybrid Electric Vehicle (HEV) | 256 |
| Fuel Tank Capacity - Hybrid Electric Vehicle (HEV) | 257 |
| Fuel and Refueling – Troubleshooting | 257 |

Catalytic Converter

| | |
|---|-----|
| What Is the Catalytic Converter | 258 |
| Catalytic Converter Precautions | 258 |
| Catalytic Converter – Troubleshooting | 258 |

High Voltage Battery - Hybrid Electric Vehicle (HEV)

| | |
|--|-----|
| What Is the High Voltage Battery | 259 |
| High Voltage Battery Precautions | 259 |

Automatic Transmission

| | |
|--|-----|
| Automatic Transmission Precautions | 260 |
| Automatic Transmission Positions | 260 |
| Shifting Your Vehicle Into Gear | 261 |

| | |
|--|-----|
| Shifting Your Vehicle Into Gear - Raptor | 261 |
| Shifting Your Vehicle Into Gear - Police Responder | 262 |
| Manually Shifting Gears | 262 |
| Temporary Neutral Mode | 264 |
| Using Progressive Range Selection | 265 |
| Automatic Return to Park (P) | 265 |
| Stowing the Selector Lever | 266 |
| Stowing the Selector Lever - Raptor | 266 |
| Manual Park Release | 267 |
| Automatic Transmission Audible Warnings | 268 |

Four-Wheel Drive

| | |
|--|-----|
| How Does Four-Wheel Drive Work | 269 |
| How Does Four-Wheel Drive Work - Raptor | 269 |
| Four-Wheel Drive Precautions | 270 |
| Four-Wheel Drive Limitations | 270 |
| Selecting a Four-Wheel Drive Mode | 271 |
| Selecting a Four-Wheel Drive Mode - Raptor | 272 |
| Four-Wheel Drive Modes | 273 |
| Four-Wheel Drive Indicators | 274 |
| Four-Wheel Drive – Troubleshooting | 274 |

Electronic Locking Differential

| | |
|---|-----|
| What Is the Electronic Locking Differential | 279 |
| How Does the Electronic Locking Differential Work | 279 |
| How Does the Electronic Locking Differential Work - Raptor | 279 |
| Electronic Locking Differential Precautions | 279 |
| Switching the Electronic Locking Differential On and Off - 4x4 | 280 |
| Switching the Electronic Locking Differential On and Off - Raptor | 281 |

Table of Contents

| | |
|---|-----|
| Switching the Electronic Locking Differential On and Off - 4x2 | 283 |
| Electronic Locking Differential Indicators | 283 |
| Electronic Locking Differential – Troubleshooting | 284 |
| Brakes | |
| Brake Precautions | 286 |
| Anti-Lock Braking System | 286 |
| Brake Over Accelerator | 286 |
| Brake Over Accelerator - Raptor | 286 |
| Locating the Brake Fluid Reservoir | 286 |
| Checking the Brake Fluid | 287 |
| Brake Fluid Specification | 287 |
| Brakes – Troubleshooting | 288 |
| Electric Parking Brake | |
| What Is the Electric Parking Brake | 289 |
| Applying the Electric Parking Brake | 289 |
| Applying the Electric Parking Brake in an Emergency | 289 |
| Manually Releasing the Electric Parking Brake | 289 |
| Automatically Releasing the Electric Parking Brake | 289 |
| Electric Parking Brake Audible Warning | 290 |
| Releasing the Electric Parking Brake if the Vehicle Battery Has Run Out of Charge | 290 |
| Electric Parking Brake – Troubleshooting | 290 |
| Reverse Braking Assist | |
| What Is Reverse Braking Assist | 292 |
| How Does Reverse Braking Assist Work | 292 |
| Reverse Braking Assist Precautions | 292 |
| Switching Reverse Braking Assist On and Off | 293 |
| Overriding Reverse Braking Assist | 293 |
| Reverse Braking Assist Indicators | 293 |
| Reverse Braking Assist – Troubleshooting | 294 |
| Hill Start Assist | |
| What Is Hill Start Assist | 296 |
| How Does Hill Start Assist Work | 296 |
| Hill Start Assist Precautions | 296 |
| Hill Start Assist – Troubleshooting | 296 |
| Auto Hold | |
| How Does Auto Hold Work | 297 |
| Switching Auto Hold On and Off | 297 |
| Using Auto Hold | 297 |
| Auto Hold Indicators | 297 |
| Traction Control | |
| What Is Traction Control | 298 |
| How Does Traction Control Work | 298 |
| Switching Traction Control On and Off | 298 |
| Traction Control Indicator | 298 |
| Traction Control – Troubleshooting | 299 |
| Stability Control | |
| How Does Stability Control Work | 300 |
| Switching Stability Control On and Off | 301 |
| Stability Control Indicator | 302 |
| Trail Control | |
| What Is Trail Control - Raptor | 303 |
| Trail Control Limitations - Raptor | 303 |
| Switching Trail Control On and Off - Raptor | 303 |
| Setting the Trail Control Speed - Raptor | 303 |
| Canceling the Set Speed - Raptor | 303 |
| Trail Control Indicators - Raptor | 304 |
| Trail One Pedal Drive | 304 |

Table of Contents

| | |
|--|-----|
| Trail One Pedal Drive – Troubleshooting | 305 |
| Trail Control – Troubleshooting - Raptor | 306 |

Trail Turn Assist

| | |
|--|-----|
| What Is Trail Turn Assist | 307 |
| Trail Turn Assist Precautions | 307 |
| Trail Turn Assist Limitations | 307 |
| Switching Trail Turn Assist On and Off | 307 |
| Trail Turn Assist Indicators | 307 |
| Trail Turn Assist – Troubleshooting | 308 |

Hill Descent Control

| | |
|---|-----|
| What Is Hill Descent Control | 309 |
| How Does Hill Descent Control Work | 309 |
| Hill Descent Control Precautions | 309 |
| Switching Hill Descent Control On and Off | 309 |
| Setting the Hill Descent Speed | 309 |
| Hill Descent Control Indicator | 309 |
| Hill Descent Control – Troubleshooting | 310 |

Steering

| | |
|----------------------------------|-----|
| Electric Power Steering | 311 |
| Steering – Troubleshooting | 312 |

Parking Aids

| | |
|--|-----|
| Parking Aid Precautions | 313 |
| Switching Parking Aid On and Off | 313 |
| Rear Parking Aid | 314 |
| Front Parking Aid | 314 |
| Side Parking Aid | 315 |
| Parking Aid Indicators | 317 |
| Parking Aids – Troubleshooting | 317 |

Rear View Camera

| | |
|------------------------------------|-----|
| What Is the Rear View Camera | 318 |
|------------------------------------|-----|

| | |
|-------------------------------------|-----|
| Rear View Camera Precautions | 318 |
| Locating the Rear View Camera | 318 |
| Rear View Camera Guide Lines | 319 |
| Rear View Camera Settings | 319 |

360 Degree Camera

| | |
|---|-----|
| What Is the 360 Degree Camera | 321 |
| How Does the 360 Degree Camera Work | 321 |
| 360 Degree Camera Precautions | 321 |
| 360 Degree Camera Limitations | 321 |
| Locating the 360 Degree Cameras | 321 |
| Locating the 360 Degree Cameras - Raptor/Tremor | 322 |
| 360 Degree Camera Guide Lines | 322 |
| 360 Degree Camera Settings | 323 |

Active Park Assist

| | |
|---|-----|
| What Is Active Park Assist | 325 |
| How Does Active Park Assist Work | 325 |
| Active Park Assist Precautions | 325 |
| Switching Active Park Assist On and Off | 325 |
| Entering a Parallel Parking Space | 325 |
| Entering a Perpendicular Parking Space | 326 |
| Exiting a Parking Space | 326 |
| Active Park Assist – Troubleshooting | 327 |

Cruise Control

| | |
|---|-----|
| What Is Cruise Control | 329 |
| Switching Cruise Control On and Off | 329 |
| Setting the Cruise Control Speed | 329 |
| Canceling the Set Speed | 330 |
| Resuming the Set Speed | 330 |
| Cruise Control Indicators | 330 |

Table of Contents

Adaptive Cruise Control

| | |
|--|-----|
| How Does Adaptive Cruise Control With Stop and Go Work | 331 |
| Adaptive Cruise Control Precautions | 331 |
| Adaptive Cruise Control Limitations | 332 |
| Switching Adaptive Cruise Control On and Off | 333 |
| Adaptive Cruise Control Automatic Cancellation | 334 |
| Setting the Adaptive Cruise Control Speed | 334 |
| Setting the Adaptive Cruise Control Gap | 335 |
| Canceling the Set Speed | 336 |
| Resuming the Set Speed | 336 |
| Overriding the Set Speed | 337 |
| Adaptive Cruise Control Indicators | 337 |
| Switching From Adaptive Cruise Control to Cruise Control | 337 |
| Lane Centering | 338 |
| Intelligent Adaptive Cruise Control | 340 |
| Adaptive Cruise Control – Troubleshooting | 341 |

BlueCruise

| | |
|---|-----|
| What Is BlueCruise | 344 |
| How Does BlueCruise Work | 344 |
| BlueCruise Precautions | 344 |
| BlueCruise Requirements | 345 |
| BlueCruise Limitations | 345 |
| BlueCruise Settings | 346 |
| Switching BlueCruise On and Off | 346 |
| BlueCruise Alerts | 347 |
| BlueCruise Automatic Cancellation | 347 |
| BlueCruise Indicators | 347 |
| BlueCruise – Troubleshooting | 348 |

Drive Mode Control

| | |
|----------------------------------|-----|
| What Is Drive Mode Control | 350 |
|----------------------------------|-----|

| | |
|--|-----|
| How Does Drive Mode Control Work | 350 |
| Selecting a Drive Mode | 350 |
| Selecting a Drive Mode – Raptor | 351 |
| Drive Modes | 352 |
| Drive Mode Control – Troubleshooting | 359 |

Lane Keeping System

| | |
|--|-----|
| What Is the Lane Keeping System | 361 |
| How Does the Lane Keeping System Work | 361 |
| Lane Keeping System Precautions | 361 |
| Lane Keeping System Limitations | 361 |
| Switching the Lane Keeping System On and Off | 362 |
| Switching the Lane Keeping System Mode | 362 |
| Alert Mode | 362 |
| Aid Mode | 363 |
| Alert and Aid Mode | 363 |
| Lane Keeping System Indicators | 364 |
| Lane Keeping System – Troubleshooting | 365 |

Blind Spot Information System

| | |
|---|-----|
| What Is Blind Spot Information System | 368 |
| How Does Blind Spot Information System Work | 368 |
| Blind Spot Information System Precautions | 368 |
| Blind Spot Information System Limitations | 368 |
| Blind Spot Information System Requirements | 368 |
| Switching Blind Spot Information System On and Off | 368 |
| Locating the Blind Spot Information System Sensors | 369 |
| Blind Spot Information System With Trailer Coverage | 369 |

Table of Contents

| | |
|---|-----|
| Blind Spot Information System Indicators | 371 |
| Blind Spot Information System – Troubleshooting | 371 |

Cross Traffic Alert

| | |
|--|-----|
| What Is Cross Traffic Alert | 372 |
| How Does Cross Traffic Alert Work | 372 |
| Cross Traffic Alert Precautions | 372 |
| Cross Traffic Alert Limitations | 372 |
| Switching Cross Traffic Alert On and Off | 373 |
| Locating the Cross Traffic Alert Sensors | 373 |
| Cross Traffic Alert Indicators | 373 |
| Cross Traffic Alert – Troubleshooting | 374 |

Pre-Collision Assist

| | |
|--|-----|
| What Is Pre-Collision Assist | 375 |
| How Does Pre-Collision Assist Work | 375 |
| Pre-Collision Assist Precautions | 375 |
| Pre-Collision Assist Limitations | 376 |
| Switching Pre-Collision Assist On and Off - Police Responder | 377 |
| Switching Pre-Collision Assist On and Off | 377 |
| Locating the Pre-Collision Assist Sensors - Police Responder | 378 |
| Locating the Pre-Collision Assist Sensors | 378 |
| Distance Indication | 379 |
| Distance Alert | 380 |
| Automatic Emergency Braking | 381 |
| Evasive Steering Assist | 381 |
| Pre-Collision Assist – Troubleshooting | 382 |

Driver Alert

| | |
|----------------------------------|-----|
| What Is Driver Alert | 386 |
| How Does Driver Alert Work | 386 |

| | |
|---|-----|
| Driver Alert Precautions | 386 |
| Driver Alert Limitations | 386 |
| Switching Driver Alert On and Off | 386 |
| Driver Alert – Troubleshooting | 387 |

Load Carrying

| | |
|---|-----|
| Load Carrying Precautions | 388 |
| Using a Slide-In Camper | 389 |
| Locating the Safety Compliance Certification Labels | 389 |
| What Is the Gross Axle Weight Rating | 389 |
| What Is the Gross Vehicle Weight Rating | 389 |
| What Is the Gross Combined Weight Rating | 390 |
| Calculating Payload | 391 |
| Calculating the Load Limit | 391 |

Pickup Bed

| | |
|--------------------------------|-----|
| Pickup Bed Precautions | 394 |
| Pickup Bed Anchor Points | 394 |
| Tailgate Anchor Points | 395 |
| Pickup Bed Ramps | 396 |

Connecting a Trailer

| | |
|--|-----|
| Connecting a Trailer Precautions | 399 |
| Hitches | 399 |
| Connecting a Trailer | 399 |
| Trailer Lighting Check | 401 |
| Connecting a Trailer – Troubleshooting | 402 |

Towing a Trailer

| | |
|---|-----|
| Towing a Trailer Precautions | 403 |
| Trailer Brake Precautions | 403 |
| Towing a Trailer Limitations | 404 |
| Loading Your Trailer | 404 |
| Trailer Towing Hints | 404 |
| Launching or Retrieving a Boat or Personal Watercraft | 405 |

Table of Contents

| | | | |
|--|-----|---|-----|
| Towing Weights and Dimensions | 406 | On-Board Scale | |
| Towing a Trailer – Troubleshooting | 408 | What Is On-Board Scale | 420 |
| Integrated Trailer Brake Controller | | How Does On-Board Scale Work | 420 |
| What Is the Integrated Trailer Brake Controller | 410 | On-Board Scale Limitations | 420 |
| Integrated Trailer Brake Controller Precautions | 410 | Using On-Board Scale | 420 |
| Using the Integrated Trailer Brake Controller | 410 | Trailer Backup Assistance | |
| Adjusting the Integrated Trailer Brake Controller Mode | 411 | What is Trailer Backup Assistance | 422 |
| Integrated Trailer Brake Controller – Troubleshooting | 412 | How Does Trailer Backup Assistance Work | 422 |
| Trailer Sway Control | | Trailer Backup Assistance Precautions | 422 |
| How Does Trailer Sway Control Work | 414 | Setting Up the Trailer Backup Assistance for a Conventional Trailer | 422 |
| Trailer Sway Control Precautions | 414 | Switching Trailer Backup Assistance On and Off | 426 |
| Switching Trailer Sway Control On and Off | 414 | Using the Trailer Backup Assistance Controller | 427 |
| Trailer Hitching Assistance | | Using the Trailer Backup Assistance Views | 427 |
| What Is Trailer Hitching Assistance | 415 | Trailer Backup Assistance – Troubleshooting | 430 |
| How Does Trailer Hitching Assistance Work | 415 | Trailer Reverse Guidance | |
| Trailer Hitching Assistance Precautions | 415 | What Is Trailer Reverse Guidance | 437 |
| Trailer Hitching Assistance Limitations | 415 | How Does Trailer Reverse Guidance Work | 437 |
| Switching Trailer Hitching Assistance On and Off | 416 | Trailer Reverse Guidance Precautions | 437 |
| Using Trailer Hitching Assistance | 416 | Setting Up Trailer Reverse Guidance for a Conventional Trailer | 437 |
| Trailer Hitching Assistance Indicators | 417 | Switching Trailer Reverse Guidance On and Off | 440 |
| Smart Hitch | | Using Trailer Reverse Guidance Views | 441 |
| What Is Smart Hitch | 418 | Trailer Reverse Guidance – Troubleshooting | 443 |
| How Does Smart Hitch Work | 418 | Driving Hints | |
| Smart Hitch Limitations | 418 | Off-Road Driving | 449 |
| Using Smart Hitch | 418 | Cold Weather Precautions | 455 |
| | | Driving on Snow and Ice | 455 |

Table of Contents

| | |
|-------------------------------------|-----|
| Breaking-In | 455 |
| Driving Economically | 455 |
| Driving in Special Conditions | 456 |
| Floor Mats | 456 |

Snow Plowing - Vehicles Without: Snow Plow Mode

| | |
|--------------------------------|-----|
| Snow Plowing Precautions | 458 |
|--------------------------------|-----|

Snow Plowing - Vehicles With: Snow Plow Mode

| | |
|--|-----|
| Snow Plowing Precautions | 459 |
| Operating Your Vehicle With a Snowplow | 459 |
| Snowplow Mode | 460 |

Crash and Breakdown Information

| | |
|--|-----|
| Roadside Assistance | 462 |
| High Voltage Battery Vehicle Precautions - Hybrid Electric Vehicle (HEV) | 463 |
| Switching the Hazard Flashers On and Off | 464 |
| Jump Starting the Vehicle | 464 |
| Post-Crash Alert System | 466 |
| Automatic Crash Shutoff | 466 |
| Recovery Towing | 467 |
| Transporting the Vehicle | 468 |

Towing Your Vehicle

| | |
|--|-----|
| Towing Your Vehicle Precautions | 469 |
| Recreationally Towing Your Vehicle - 4x4 | 469 |
| Recreationally Towing Your Vehicle - 4x2 | 471 |
| Emergency Towing | 471 |
| Towing Your Vehicle – Troubleshooting | 471 |

Fuses

| | |
|------------------------------------|-----|
| Fuse Precautions | 472 |
| Under Hood Fuse Box | 472 |
| Body Control Module Fuse Box | 478 |
| Identifying Fuse Types | 481 |
| Fuses – Troubleshooting | 481 |

Maintenance

| | |
|--|-----|
| Maintenance Precautions | 482 |
| Opening and Closing the Hood | 482 |
| Under Hood Overview - 2.7L EcoBoost™ | 483 |
| Under Hood Overview - 3.3L | 484 |
| Under Hood Overview - 3.5L EcoBoost™ | 485 |
| Under Hood Overview - 3.5L, Hybrid Electric Vehicle (HEV) | 486 |
| Under Hood Overview - 5.0L | 487 |
| Engine Oil | 488 |
| Checking the Coolant | 489 |
| Engine Air Filter | 493 |
| Changing the Fuel Filter - Gasoline | 493 |
| Changing the 12V Battery | 494 |
| Adjusting the Headlamps - Vehicles With: LED Headlamps | 496 |
| Adjusting the Headlamps - Vehicles With: Halogen Headlamps | 497 |
| Exterior Bulbs | 499 |
| Interior Bulbs | 508 |
| Drive Belt Routing - 2.7L EcoBoost™, Vehicles With: Dual Generators | 508 |
| Drive Belt Routing - 2.7L EcoBoost™, Vehicles With: Single Generator | 508 |
| Drive Belt Routing - 3.3L | 508 |
| Drive Belt Routing - 3.5L EcoBoost™, Vehicles With: Dual Generators | 509 |
| Drive Belt Routing - 3.5L EcoBoost™, Vehicles With: Single Generator | 509 |
| Drive Belt Routing - 3.5L, Hybrid Electric Vehicle (HEV) | 509 |
| Drive Belt Routing - 5.0L, Vehicles With: Dual Generators | 509 |

Table of Contents

| | | | |
|---|-----|---|-----|
| Drive Belt Routing - 5.0L, Vehicles With: Single Generator | 510 | Tire Pressure Monitoring System Limitations | 537 |
| Vehicle Care | | Viewing the Tire Pressures | 538 |
| Cleaning Products | 511 | Resetting Tire Pressure Monitoring System | 538 |
| Cleaning the Exterior | 511 | Tire Pressure Monitoring System – Troubleshooting | 541 |
| Cleaning the Interior | 513 | Changing a Road Wheel | |
| Repairing Minor Paint Damage | 515 | Changing a Flat Tire | 543 |
| Waxing Your Vehicle | 516 | Changing a Flat Tire - Raptor/Tremor | 549 |
| Storing Your Vehicle | | Wheel Nuts | 556 |
| Preparing Your Vehicle for Storage | 517 | Capacities and Specifications | |
| Removing Your Vehicle From Storage | 518 | Engine Specifications - 2.7L EcoBoost™ | 558 |
| Wheel and Tire Information | | Engine Specifications - 3.3L | 559 |
| Locating the Tire label | 519 | Engine Specifications - 3.5L Ecoboost™ | 560 |
| Department of Transportation Uniform Tire Quality Grades | 519 | Engine Specifications - 3.5L, Hybrid Electric Vehicle (HEV) | 561 |
| Information on the Tire Sidewall | 520 | Engine Specifications - 5.0L | 562 |
| Glossary of Tire Terminology | 525 | Motorcraft Parts - 2.7L EcoBoost™ | 563 |
| Tire Replacement Requirements | 526 | Motorcraft Parts - 3.3L | 564 |
| Using Snow Chains | 528 | Motorcraft Parts - 3.5L Ecoboost™ | 565 |
| Using Bead-Lock Wheels - Raptor | 530 | Motorcraft Parts - 3.5L, Hybrid Electric Vehicle (HEV) | 566 |
| Tire Care | | Motorcraft Parts - 5.0L | 567 |
| Checking the Tire Pressures | 532 | Motorcraft Parts - Raptor | 568 |
| Inflating the Tires | 532 | Engine Oil Capacity and Specification - 2.7L EcoBoost™ | 569 |
| Inspecting the Tire for Wear | 533 | Engine Oil Capacity and Specification - 3.3L | 570 |
| Inspecting the Tire for Damage | 533 | Engine Oil Capacity and Specification - 3.5L Ecoboost™ | 572 |
| Inspecting the Wheel Valve Stems | 534 | Engine Oil Capacity and Specification - 3.5L, Hybrid Electric Vehicle (HEV) | 574 |
| Tire Rotation | 534 | Engine Oil Capacity and Specification - 5.0L | 576 |
| Tire Pressure Monitoring System | | | |
| What Is the Tire Pressure Monitoring System | 536 | | |
| Tire Pressure Monitoring System Overview | 536 | | |
| Tire Pressure Monitoring System Precautions | 537 | | |

Table of Contents

| | |
|--|-----|
| Cooling System Capacity and Specification - 2.7L EcoBoost™ | 578 |
| Cooling System Capacity and Specification - 3.3L | 579 |
| Cooling System Capacity and Specification - 3.5L EcoBoost™ | 579 |
| Cooling System Capacity and Specification - 3.5L, Hybrid Electric Vehicle (HEV) | 580 |
| Cooling System Capacity and Specification - 5.0L | 581 |
| Cooling System Capacity and Specification - Raptor, Police Responder | 581 |
| Fuel Tank Capacity - Gasoline, Hybrid Electric Vehicle (HEV) | 582 |
| Fuel Tank Capacity - Gasoline, Excluding: Hybrid Electric Vehicle (HEV) | 583 |
| Fuel Tank Capacity - Raptor | 584 |
| Air Conditioning System Capacity and Specification - 2.7L EcoBoost™ | 585 |
| Air Conditioning System Capacity and Specification - 3.3L | 586 |
| Air Conditioning System Capacity and Specification - 3.5L EcoBoost™ | 587 |
| Air Conditioning System Capacity and Specification - 3.5L, Hybrid Electric Vehicle (HEV) | 588 |
| Air Conditioning System Capacity and Specification - 5.0L | 589 |
| Washer Fluid Specification | 589 |
| Brake Fluid Specification | 590 |
| Transfer Case Fluid Capacity and Specification | 591 |
| Transfer Case Fluid Capacity and Specification - Raptor | 591 |
| Front Axle Fluid Capacity and Specification | 592 |
| Rear Axle Fluid Capacity and Specification | 593 |
| Rear Axle Fluid Capacity and Specification - Raptor | 594 |
| Rear Axle Fluid Capacity and Specification - Police Responder | 594 |

Vehicle Identification

| | |
|-------------------------------|-----|
| Vehicle Identification Number | 596 |
|-------------------------------|-----|

Connected Vehicle

| | |
|--|-----|
| What Is a Connected Vehicle | 597 |
| Connected Vehicle Requirements | 597 |
| Connected Vehicle Limitations | 597 |
| Connecting the Vehicle to a Mobile Network | 597 |
| Connecting the Vehicle to a Wi-Fi Network | 597 |
| Connected Vehicle – Troubleshooting | 598 |

Vehicle Wi-Fi Hotspot

| | |
|---|-----|
| Creating a Vehicle Wi-Fi Hotspot | 601 |
| Changing the Vehicle Wi-Fi Hotspot Name or Password | 601 |

Audio System

| | |
|-------------------------------------|-----|
| Audio System Precautions | 603 |
| Identifying the Audio Unit | 603 |
| Switching the Audio Unit On and Off | 603 |
| Selecting the Audio Source | 603 |
| Playing or Pausing the Audio Source | 603 |
| Adjusting the Volume | 604 |
| Switching Shuffle Mode On and Off | 604 |
| Switching Repeat Mode On and Off | 604 |
| Setting a Memory Preset | 604 |
| Muting the Audio | 604 |
| Adjusting the Sound Settings | 604 |
| Setting the Clock and Date | 605 |
| AM/FM Radio | 605 |
| Switching the Display On and Off | 606 |
| Digital Radio | 606 |
| Satellite Radio | 607 |
| Audio System – Troubleshooting | 610 |

Table of Contents

Center Display Overview

| | |
|---|-----|
| Center Display Precautions | 614 |
| Center Display Limitations | 614 |
| Status Bar | 614 |
| Feature Bar | 615 |
| Information On Demand Screen - Vehicles With: 12.3 Inch Screen | 616 |
| Rebooting the Center Display | 616 |

Voice Interaction

| | |
|-------------------------------------|-----|
| What is Voice Interaction | 617 |
| Setting the Wake Word | 617 |
| Beginning a Voice Interaction | 617 |
| Voice Interaction Examples | 617 |

Phone

| | |
|---|-----|
| Phone Precautions | 620 |
| Connecting Your Phone | 620 |
| Phone Menu | 620 |
| Making and Receiving a Phone Call | 622 |
| Sending and Receiving a Text Message | 623 |
| Switching Text Message Notification On and Off | 624 |

Bluetooth®

| | |
|--------------------------------------|-----|
| Connecting a Bluetooth® Device | 625 |
| Playing Media Using Bluetooth® | 625 |

Apps

| | |
|---|-----|
| App Precautions | 626 |
| App Requirements | 626 |
| Accessing Apps | 626 |
| Enabling Apps on an iOS Device | 626 |
| Enabling Apps on an Android Device | 626 |
| Switching Apple CarPlay On and Off | 627 |
| Switching Android Auto On and Off | 627 |

Personal Profiles

| | |
|--|-----|
| How Do Personal Profiles Work | 628 |
| Enabling or Disabling Personal Profiles | 628 |
| Creating a Personal Profile | 629 |
| Linking or Unlinking a Personal Profile to a Remote Control | 629 |

Navigation

| | |
|---------------------------------|-----|
| Accessing Navigation | 630 |
| Navigation Map Updates | 630 |
| Adjusting the Map | 630 |
| Live Traffic | 630 |
| Setting a Destination | 630 |
| Waypoints | 631 |
| Route Guidance | 631 |
| Trailer Towing Navigation | 632 |

Vehicle System Updates

| | |
|--|-----|
| Updating the Vehicle Systems Wirelessly | 633 |
| Performing a Master Reset | 634 |

Accessories

| | |
|-------------------|-----|
| Accessories | 635 |
|-------------------|-----|

Auxiliary Switches

| | |
|--|-----|
| What Are the Auxiliary Switches | 636 |
| Locating the Auxiliary Switches | 636 |
| Locating the Auxiliary Switch Wiring | 637 |
| Identifying the Auxiliary Switch Wiring | 637 |

Warranty Terms and Conditions - Raptor

| | |
|---------------------|-----|
| Base Warranty | 639 |
|---------------------|-----|

Ford Protect

| | |
|----------------------------|-----|
| What Is Ford Protect | 640 |
|----------------------------|-----|

Table of Contents

Scheduled Maintenance

| | |
|--|-----|
| General Maintenance Information | 642 |
| Normal Scheduled Maintenance | 645 |
| Special Operating Conditions Scheduled Maintenance - Gasoline | 648 |
| Special Operating Conditions Scheduled Maintenance - Raptor | 651 |

Decommissioning the Vehicle - Police Responder

| | |
|------------------------------------|-----|
| Decommissioning Requirements | 655 |
|------------------------------------|-----|

Customer Information

| | |
|--|-----|
| Rollover Warning | 656 |
| The Better Business Bureau Auto Line Program | 656 |
| The Mediation and Arbitration Program | 657 |
| Ordering a Canadian French Owner's Manual | 657 |
| Reporting Safety Defects in the United States | 658 |
| Reporting Safety Defects in Canada | 658 |
| Radio Frequency Certification Labels | 659 |
| Perchlorate | 687 |
| Replacement Parts Recommendation | 688 |
| Mobile Communications Equipment | 688 |
| End User License Agreement | 689 |
| Emission Law | 714 |
| Export Unique Options | 715 |

Appendices

| | |
|-------------------------------------|-----|
| Electromagnetic Compatibility | 716 |
|-------------------------------------|-----|

About Us - Raptor

SVT

The Ford Special Vehicle Team (SVT) was established in 1991 to polish the Ford Oval by creating low-volume, factory-produced vehicles designed for those select few whose idea of driving is a high-powered, passionate experience – not just a means of getting from point A to point B.

In a move to support this spirited enthusiasm, Ford Motor Company carefully integrated the wide array of talent in the company into a small, cross-functional group of engineers and product planners, housed together under one roof with a common mission: to create vehicles specifically designed to meet the unique needs and desires of the knowledgeable driving enthusiast.

More than 400,000 SVT and Ford Performance vehicles were produced since the 1993 model year. These include the SVT Mustang Cobra and the Cobra R, the SVT F-150 Lightning, the SVT Contour, the SVT Focus, Ford GT, Shelby GT350, Shelby GT500, GT500KR and the F-150 SVT Raptor.

TEAM RS

Team RS traces its roots back nearly 60 years from the Lotus Ford Cortina and Twin Cam Escorts of the mid 1960's, through the first RS branded Escorts of the 1970's to the founding of Special Vehicle Engineering (SVE) in 1980. Through the 1980s and 90s, SVE delivered a breadth of vehicles from exciting XR and RS branded road going performance cars through homologation specials such as the iconic Sierra Cosworth RS500. The first ST (Sport Technology) vehicle appeared in 1996 as the ST24 Mondeo. The first collaboration between Ford's European and North American performance teams appeared in 2002 as the ST170 in Europe

and SVT Focus in North America. In 2003, Team RS replaced SVE in Europe as performance car and motorsport personnel were brought together as one team. Team RS subsequently created the 2004 Fiesta ST, 2005 Focus ST and 2009 Focus RS.

FORD PERFORMANCE

Welcome to the Ford Performance family!

SVT and Team RS officially began working together as one team in 2009. In 2015, these two teams, along with Ford Racing, were formally combined establishing Ford Performance as a single team responsible for all performance and racing oriented products and activities worldwide at Ford Motor Company. Your Ford Performance vehicle represents the best of what Ford Performance has to offer from around the globe. Your vehicle has been designed and developed with the four hallmarks of Ford Performance in mind: Performance, Substance, Exclusivity and Value. We are proud and passionate about what we do, and we are glad you have made us your choice.

Included in the purchase price of your Ford Performance vehicle is a one day class at the Ford Performance racing school. For additional information, refer to www.fordperformanceracingschool.com.



Contacting Us

If you require assistance or clarification on policies or procedures, please contact the customer relationship center.

United States

Ford Motor Company
Customer Relationship Center
PO Box 6248
Dearborn, MI 48126
1-800-392-3673 (FORD)
TDD for the hearing impaired:
7-1-1 (where offered by your telephone
service provider)
www.ford.com/help/contact/

Ford Credit - US Only

Ford Credit offers a full range of financing and lease plans to help you acquire your vehicle. If you have financed or leased your vehicle through Ford Credit, thank you for your business.

For assistance call 1-800-727-7000, or for more information about Ford Credit and access to an account manager, visit www.ford.com/finance.

Canada

Customer Relationship Center
Ford Motor Company of Canada Limited
P.O. Box 2000
Oakville, Ontario L6J 5E4
1-800-565-3673 (FORD)
TDD for the hearing impaired:
7-1-1 (where offered by your telephone
service provider)
www.ford.ca
Facebook: FordServiceCA (English),
FordServiceQC (Français)

Australia

Ford Motor Company
Attention: Customer Relationship Centre
Private Mail Bag 5
Fairlane Business Park #3
Campbellfield, Victoria, 3061
Telephone: 13 3673 (FORD)
E-mail: foacust1@ford.com

New Zealand

Ford Motor Company
Attention: Customer Relationship Centre
Private Bag 76912
Manukau City 2241
Telephone: 0800 367 369 (FORDNZ)
E-mail: fnzcust@ford.com

China - Imported Vehicle

Customer Relationship Center
Telephone: 400-690-1886
Website: <https://www.ford.com.cn/>

China - Chang'An Ford

Customer Relationship Center
Telephone: 800-810-8168
Mobile: 400-887-7766
Website: <https://www.ford.com.cn/>

Asia Pacific

E-mail: expcac@ford.com

Caribbean, Central America and Israel

Ford Motor Company
Ford Export Operations
Attention: Owner Relations
1555 Fairlane Drive
Fairlane Business Park #3
Allen Park, MI 48101
Fax: (313) 390-0804
Telephone: (313) 594-4857
E-mail: expcac@ford.com

Contacting Us

U.S. Virgin Islands and Puerto Rico

Ford Motor Company
Ford Export Operations
Attention: Owner Relations
1555 Fairlane Drive
Fairlane Business Park #3
Allen Park, MI 48101
Telephone: (800) 841-3673
E-mail: prcac@ford.com

Argentina

Telephone: 0800-888-3673

Brazil

www.ford.com.br

North Africa

E-mail: nafcrc@ford.com

Sub-Saharan Africa

E-mail: ssacrc@ford.com

Puerto Rico

Ford International Business Development,
Inc.
P.O. Box 11957
Caparra Heights Station
San Juan, PR 00922-1957
1-800-392-3673 (FORD)
Fax: (313) 390-0804
E-mail: prcac@ford.com
www.ford.com.pr

Middle East

Ford Middle East Customer Relationship
Center
P.O. Box 21740
Dubai, United Arab Emirates
Telephone: 80004441066
Toll-free number for the Kingdom of Saudi
Arabia: 8008443673
Mobily and Zain cell phone users in Saudi
Arabia: 800850078
Kuwait: 22280384
Local telephone number for Kuwait: +965
1 898900
Fax: +971 4 3327266
E-mail: menacac@ford.com
www.me.ford.com

South Korea

Telephone: +82-02-1600-6003
E-mail: infokr1@ford.com

Introduction

ABOUT THIS PUBLICATION



WARNING: Driving while distracted can result in loss of vehicle control, crash and injury. We strongly recommend that you use extreme caution when using any device that may take your focus off the road. Your primary responsibility is the safe operation of your vehicle. We recommend against the use of any hand-held device while driving and encourage the use of voice-operated systems when possible. Make sure you are aware of all applicable local laws that may affect the use of electronic devices while driving.



WARNING: You risk death, fire, or serious injury to yourself and others if you do not follow the instruction highlighted by the warning symbol.

Thank you for choosing Ford. We recommend that you take some time to get to know your vehicle in order to benefit from greater safety and pleasure from driving it. Use this publication to familiarize yourself with the basics and then read the digital version, that is available in your vehicle. You can also view the comprehensive manual through the FordPass app and through the local Ford website.

Note: To download the FordPass app, visit your device's app store.

Note: To find the local Ford website, visit <https://corporate.ford.com/operations/locations/global-links.html>.

Note: Use and operate your vehicle in line with all applicable laws and regulations.

Note: Pass on all printed owner's information when selling this vehicle.

Our digital resources include a comprehensive digital Owner's Manual dynamically created according to the features on your vehicle by using the vehicle identification number. See **Locating the Vehicle Identification Number** (page 596). The digital Owner's Manual includes visual and full text search functions so that you can quickly locate the information you are looking for. It also includes links to a number of how-to videos created to help you understand some of the advanced technologies on your vehicle.

Features and Options

This publication describes product features and options available throughout the range of available models, sometimes even before they are generally available. It could describe options that are not available on the vehicle you have purchased.

Illustrations

Some of the illustrations in this publication could show features as used in different models, so they could appear different to you on your vehicle.

Location of Components

This manual may qualify the location of a component as left-hand side or right-hand side. The side is determined when facing forward in the seat.

Introduction



- A Right-hand side.
- B Left-hand side.

USING THIS PUBLICATION

To quickly locate information about your vehicle, use the word search within the Owner's Manual application.

Symbols Glossary

SYMBOLS USED ON YOUR VEHICLE

These are some of the symbols you may see on your vehicle.



Air conditioning system



Air conditioning system lubricant type



Anti-lock braking system



Avoid smoking, flames or sparks



Battery



Battery acid



Brake fluid - non petroleum based



Brake system



Brake system



Cabin air filter



Check fuel cap



Child safety door lock or unlock



Child seat lower anchor



Child seat tether anchor



Cruise control



Do not open when hot



Electric Parking brake



Engine air filter



Engine coolant



Engine coolant temperature



Engine oil



Explosive gas



Fan warning



Fasten seatbelt



Flammable



Airbag



Front fog lamps



Fuel pump reset

Symbols Glossary



Fuse compartment



Hazard flashers



Heated rear window



Windshield defrosting system



Interior luggage compartment release



Jack



Keep out of reach of children



Lighting control



Low tire pressure warning



Maintain correct fluid level



Note operating instructions



Horn control



Panic alarm



Parking aid



Passenger airbag activated



Passenger airbag deactivated



Power steering fluid



Power windows front/rear



Power window lockout



Requires registered technician



Safety alert



See Owner's Manual



See Service Manual



Malfunction Indicator Lamp (MIL)



Side airbag



Shield the eyes



Stability control



Hill descent control



Trail control



Windshield wiping system

Symbols Glossary



Windshield wash and wipe

Data Privacy



WARNING: Do not connect wireless plug-in devices to the data link connector. Unauthorized third parties could gain access to vehicle data and impair the performance of safety related systems. Only allow repair facilities that follow our service and repair instructions to connect their equipment to the data link connector.

We respect your privacy and are committed to protecting it. The information contained in this manual was correct at the time of publication, but as technology rapidly changes, we recommend that you visit the local Ford website for the latest information.

Your vehicle has electronic control units that have data recording functionality and the ability to permanently or temporarily store data. This data could include information on the condition and status of your vehicle, vehicle maintenance requirements, events and malfunctions. The types of data that can be recorded are described in this section. Some of the data recorded is stored in event logs or error logs.

Note: *Error logs are reset following a service or repair.*

Note: *We may provide information in response to requests from law enforcement, other government authorities and third parties acting with lawful authority or through a legal process. Such information could be used by them in legal proceedings.*

Data recorded includes, for example:

- Operating states of system components, for example fuel level, tire pressure and battery charge level.
- Vehicle and component status, for example wheel speed, deceleration, lateral acceleration and seatbelt status.

- Events or errors in essential systems, for example headlamps and brakes.
- System responses to driving situations, for example airbag deployment and stability control.
- Environmental conditions, for example temperature.

Some of this data, when used in combination with other information, for example an accident report, damage to a vehicle or eyewitness statements, could be associated with a specific person.

Services That We Provide

If you use our services, we collect and use data, for example account information, vehicle location and driving characteristics, that could identify you. We transmit this data through a dedicated, protected connection. We only collect and use data to enable your use of our services to which you have subscribed, with your consent or where permitted by law. For additional information, see the terms and conditions of the services to which you have subscribed.

For additional information about our privacy policy, refer to the local Ford website.

Services That Third Parties Provide

We recommend that you review the terms and conditions and data privacy information for any services equipped with your vehicle or to which you subscribe. We take no responsibility for services that third parties provide.

Where equipped, SiriusXM with 360L could use the modem. To disable, turn off the SiriusXM with 360L or Vehicle Connectivity setting. See **Enabling and Disabling the Modem** (page 597).

Data Privacy

SERVICE DATA

Service data recorders in your vehicle are capable of collecting and storing diagnostic information about your vehicle. This potentially includes information about the performance or status of various systems and modules in the vehicle, such as engine, throttle, steering or brake systems. In order to properly diagnose and service your vehicle, Ford Motor Company (Ford of Canada in Canada), and service and repair facilities may access or share among them vehicle diagnostic information received through a direct connection to your vehicle when diagnosing or servicing your vehicle. Additionally, Ford Motor Company (Ford of Canada, in Canada) may, where permitted by law, use vehicle diagnostic information for vehicle improvement or with other information we may have about you, for example, your contact information, to offer you products or services that may interest you. Data may be provided to our service providers such as part suppliers that may help diagnose malfunctions, and who are similarly obligated to protect data. We retain this data only as long as necessary to perform these functions or to comply with law. We may provide information where required in response to official requests to law enforcement or other government authorities or third parties acting with lawful authority or court order, and such information may be used in legal proceedings. For U.S. only (if equipped), if you choose to use connected apps and services, you consent that certain diagnostic information may also be accessed electronically by Ford Motor Company and Ford authorized service facilities, and that the diagnostic information may be used to provide services to you, personalizing your experience, troubleshoot, and to improve products and services and offer you products and services that may interest

you, where permitted by law. For Canada only, for more information, please review the Ford of Canada privacy policy at www.ford.ca, including our U.S. data storage and use of service providers in other jurisdictions who may be subject to legal requirements in Canada, the United States and other countries applicable to them, for example, lawful requirements to disclose personal information to governmental authorities in those countries.

EVENT DATA

This vehicle is equipped with an event data recorder. The main purpose of an event data recorder is to record, in certain crash or near crash-like situations, such as an airbag deployment or hitting a road obstacle; this data will assist in understanding how a vehicle's systems performed. The event data recorder is designed to record data related to vehicle dynamics and safety systems for a short period of time, typically 30 seconds or less.

The event data recorder in this vehicle is designed to record such data as:

- How various systems in your vehicle were operating.
- Whether or not the driver and passenger seatbelts were buckled/fastened.
- How far (if at all) the driver was depressing the accelerator and/or the brake pedal.
- How fast the vehicle was traveling.
- Where the driver was positioning the steering wheel.

This data can help provide a better understanding of the circumstances in which crashes and injuries occur.

Data Privacy

Note: *Event data recorder data is recorded by your vehicle only if a non-trivial crash situation occurs; no data is recorded by the event data recorder under normal driving conditions and no personal data or information (for example name, gender, age, and crash location) is recorded.*

However, parties, such as law enforcement, could combine the event data recorder data with the type of personally identifying data routinely acquired during a crash investigation.

To read data recorded by an event data recorder, special equipment is required, and access to the vehicle or the event data recorder is needed. In addition to the vehicle manufacturer, other parties, such as law enforcement, that have such special equipment, can read the information if they have access to the vehicle or the event data recorder.

BlueCruise Data (If Equipped)

If BlueCruise is active in certain crash or near crash-like situations, such as an airbag deployment or hitting a road obstacle, the system may record driver attentiveness, based on the direction of eyes and duration, and photographs of the driver seat area.

Note: *No data is recorded under normal driving conditions.*

SETTINGS DATA

Your vehicle has electronic control units that have the ability to store data based on your personalized settings. The data is stored locally in the vehicle or on devices that you connect to it, for example, a USB drive or digital music player. You can delete some of this data and also choose whether to share it through the services to which you subscribe. See **Enabling and Disabling the Modem** (page 597).

Comfort and Convenience Data

Data recorded includes, for example:

- Seat and steering wheel position.
- Climate control settings.
- Radio presets.

Entertainment Data

Data recorded includes, for example:

- Music, videos or album art.
- Contacts and corresponding address book entries.
- Navigation destinations.

CONNECTED VEHICLE DATA



The modem has a SIM. The modem was enabled when your vehicle was built and periodically sends messages to stay connected to the cell phone network, receive automatic software updates and send vehicle-related information to us, for example diagnostic information. These messages could include information that identifies your vehicle, the SIM and the electronic serial number of the modem. Cell phone network service providers could have access to additional information, for example cell phone network tower identification. For additional information about our privacy policy, visit www.FordConnected.com or refer to your local Ford website.

Note: *The modem continues to send this information unless you disable the modem or stop the modem from sharing vehicle data by changing the modem settings. See **Connected Vehicle** (page 597).*

Note: *The service can be unavailable or interrupted for a number of reasons, for example environmental or topographical conditions and data plan coverage.*

Note: *To find out if your vehicle has a modem, visit www.FordConnected.com.*

Data Privacy

MOBILE DEVICE DATA

If you connect a mobile device to your vehicle, you can display data from your device on the touchscreen for example, music and album art. You can share your vehicle data with mobile apps on your device through the system. See **App Requirements** (page 626).

The mobile apps function operates by your connected device sending data to us in the United States. The data is encrypted and includes, for example, the vehicle identification number of your vehicle, the SYNC module serial number, odometer, enabled apps, usage statistics and debugging information. We retain it only as long as necessary to provide the service, to troubleshoot, for continuous improvement and to offer you products and services that may be of interest to you according to your preferences and where allowed by law.

If you connect a cell phone to the system, the system creates a profile that links to that cell phone. The cell phone profile enables more mobile features and efficient operation. The profile contains, for example data from your phonebook, read and unread text messages and call history, including history of calls when your cell phone was not connected to the system.

If you connect a media device, the system creates and retains a media device index of supported media content. The system also records a short diagnostic log of approximately 10 minutes of all recent system activity.

The cell phone profile, media device index and diagnostic log remain in your vehicle unless you delete them and are generally accessible only in your vehicle when you connect your cell phone or media device. If you no longer plan to use the system or your vehicle, we recommend you use the master reset function to erase the stored information. See **Performing a Master Reset** (page 634).

System data cannot be accessed without special equipment and access to your vehicle's module.

For additional information about our privacy policy, refer to the local Ford website.

Note: *To find out if your vehicle has connectivity technology, visit www.FordConnected.com.*

EMERGENCY CALL SYSTEM DATA (IF EQUIPPED)

When the emergency call system is active, it may disclose to emergency services that your vehicle has been in a crash involving the deployment of an airbag or activation of the fuel pump shut-off. Certain versions or updates to the emergency call system may also be capable of electronically or verbally disclosing to emergency services operators your vehicle location or other details about your vehicle or crash to assist emergency services operators to provide the most appropriate emergency services. If you do not want to disclose this information, do not activate the emergency call system.

Note: *You cannot deactivate emergency call systems that are required by law.*

At a Glance - Raptor

UNIQUE FEATURES

Powertrain

- 3.5L EcoBoost engine.
- 10R80 10-speed automatic transmission with paddle shifters and water to air transmission cooler.
- Torque On Demand™ 2-speed transfer case with 4 Hi-Loc.
- Rear differential capable of locking in 4A, 4H and 4L.
- 35 spline rear axle shafts for increased capability.
- 4.10 front and rear axle ratios and optional Torsen front differential.
- Equal length dual exhaust with X-pipe and active exhaust valves, 4.5 in (114.3 mm) exhaust tips.
- Charge air cooler fan assembly for greater cooling at low speeds.

Chassis

- Cast aluminum lower control arms.
- Forged steel upper control arms.
- Fox Factory 3.1 Live Valve Internal Bypass front shocks.
- Fox Factory 3.1 Live Valve Internal Bypass Remote Reservoir rear shocks.
- 24 inch triple rate rear springs.
- Unique underbody shields.
- Heavy duty fully boxed frame.
- Unique 5 link rear suspension.
- Unique cast aluminum knuckle.
- Ride height sensors at each corner.
- Off-road tuned stabilizer bar and jounce bumpers.

Exterior

- Optional off-road driving lights.
- Modified rear bumper with integrated rear tow hooks.
- Underbody shields plus front tow hooks.
- Hood with functional air extractors.
- Front fenders with functional air extractors.
- Front and rear LED marker lamps.
- 17 x 8.5 aluminum wheels.
- Optional 17 x 8.5 forged beadlock compatible wheels.
- LT 315/70R17 BF Goodrich All Terrain TA KO2 tires.
- Optional 37x12.5R17 LT BF Goodrich All Terrain TA KO2 tires.

Interior

- Unique terrain-mode and trail control functionality plus six auxiliary switches.
- Optional premium leather and suede seats.

Visual Search

STEERING WHEEL

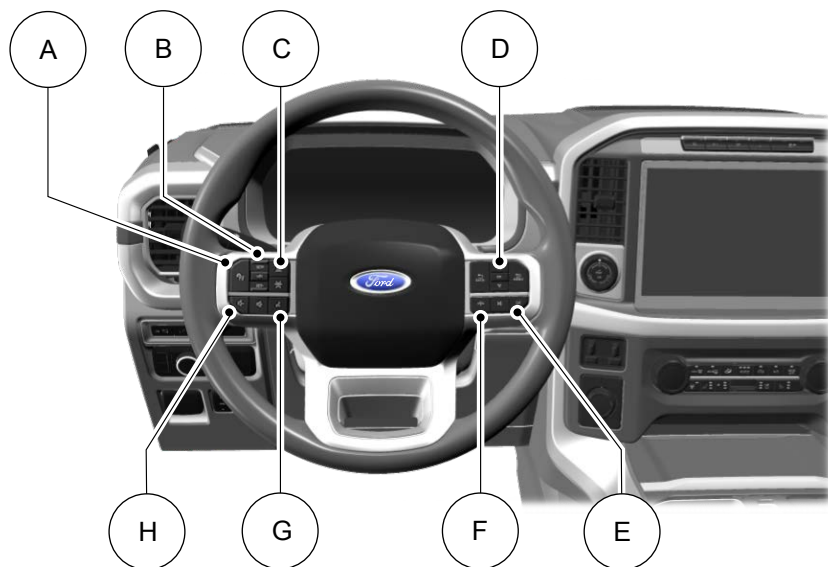

- A See **Switching Adaptive Cruise Control On and Off** (page 333).
- B See **Setting the Adaptive Cruise Control Speed** (page 334).
- C See **Setting the Adaptive Cruise Control Gap** (page 335).
- D See **Using the Instrument Cluster Display Controls** (page 173).
- E See **Selecting a Radio Station** (page 605).
- F See **Making and Receiving a Phone Call** (page 622).
- G See **What is Voice Interaction** (page 617).
- H See **Adjusting the Volume** (page 604).

Visual Search

STEERING WHEEL - RAPTOR

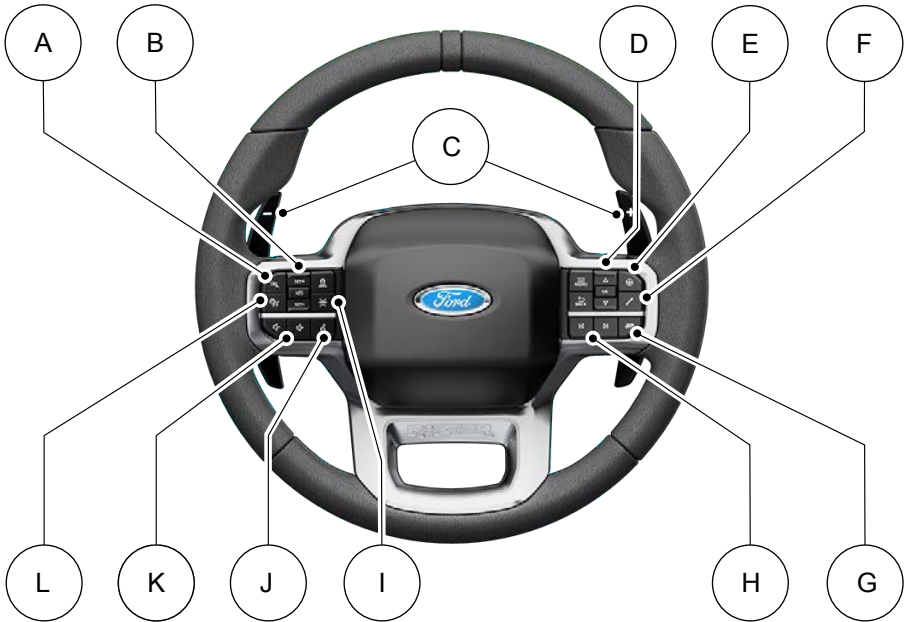

- A See **Selecting a Drive Mode** (page 351).
- B See **Setting the Adaptive Cruise Control Speed** (page 334).
- C See **Shifting Using the Paddle Shifters** (page 262).
- D See **Using the Instrument Cluster Display Controls** (page 173).
- E See **Selecting a Drive Mode** (page 351).
- F See **Selecting a Drive Mode** (page 351).
- G See **Selecting a Drive Mode** (page 351).
- H See **Selecting a Radio Station** (page 605).
- I See **Switching Lane Centering On and Off** (page 339).
- J See **Beginning a Voice Interaction** (page 617).

Visual Search

- K See **Adjusting the Volume** (page 604).
- L See **Switching Adaptive Cruise Control On and Off** (page 333).

STEERING WHEEL - POLICE RESPONDER



- A See **Adjusting the Volume** (page 604).
- B See **Using the Instrument Cluster Display Controls** (page 173).
- C See **Selecting a Radio Station** (page 605).
- D See **Making and Receiving a Phone Call** (page 622).
- E See **What is Voice Interaction** (page 617).
- F See **Adjusting the Volume** (page 604).

Visual Search

INSTRUMENT PANEL

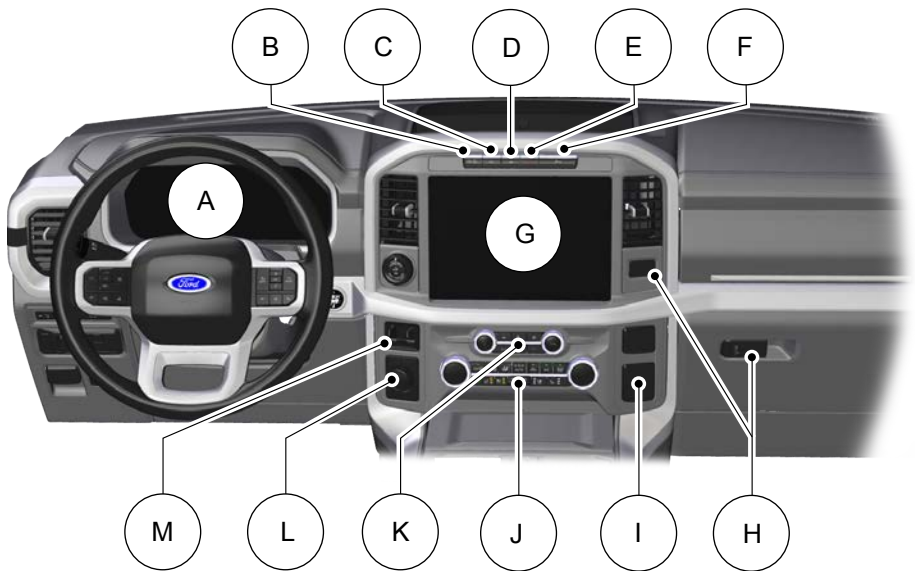

- A See **Instrument Cluster Overview** (page 168). See **Instrument Cluster Overview** (page 167). See **Instrument Cluster Overview** (page 166).
- B See **Switching Traction Control On and Off** (page 298).
- C See **Switching the 360 Degree Camera On and Off** (page 323).
- D See **Switching Active Park Assist On and Off** (page 325).
- E See **Switching the Hazard Flashers On and Off** (page 464).
- F See **Switching Snowplow Mode On and Off** (page 460).
- G See **Feature Bar** (page 615).
- H See **Opening the Glove Compartment** (page 227).
- I See **What Is the Power Outlet** (page 222).
- J See **Identifying the Climate Control Unit** (page 181). See **Identifying the Climate Control Unit** (page 186).
- K See **Switching the Audio Unit On and Off** (page 603).

Visual Search

- L See **Selecting a Four-Wheel Drive Mode** (page 271).
- M See **Using the Integrated Trailer Brake Controller** (page 410).

INSTRUMENT PANEL - RAPTOR

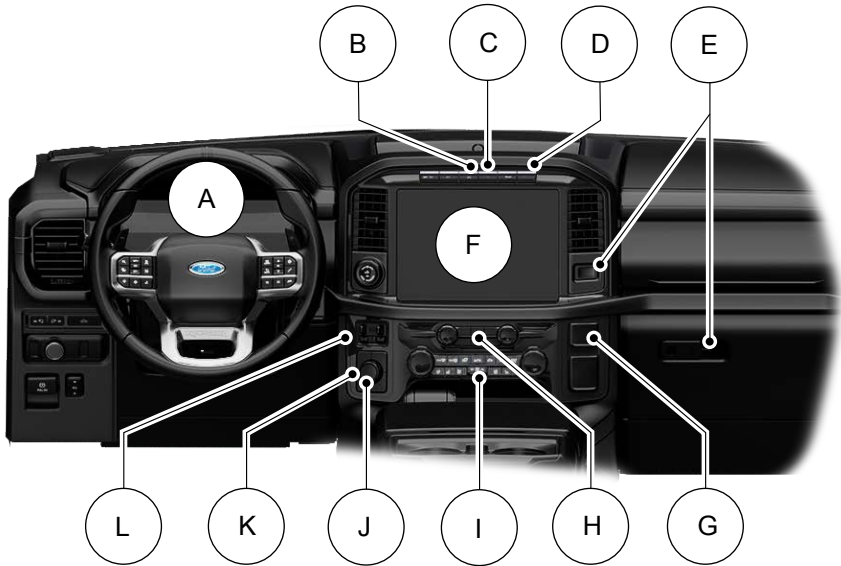

- A See **Instrument Cluster Overview** (page 168). See **Instrument Cluster Overview** (page 167). See **Instrument Cluster Overview** (page 166).
- B See **Switching Active Park Assist On and Off** (page 325).
- C See **Switching the Hazard Flashers On and Off** (page 464).
- D See **Switching Trail Control On and Off** (page 303).
- E See **Opening the Glove Compartment** (page 227).
- F See **Feature Bar** (page 615).
- G See **What Is the Power Outlet** (page 222).
- H See **Identifying the Audio Unit** (page 603).

Visual Search

- I See **Identifying the Climate Control Unit** (page 181). See **Identifying the Climate Control Unit** (page 186).
- J See **Selecting a Drive Mode** (page 351).
- K See **Selecting a Four-Wheel Drive Mode** (page 271).
- L See **Using the Integrated Trailer Brake Controller** (page 410).

INSTRUMENT PANEL - POLICE RESPONDER

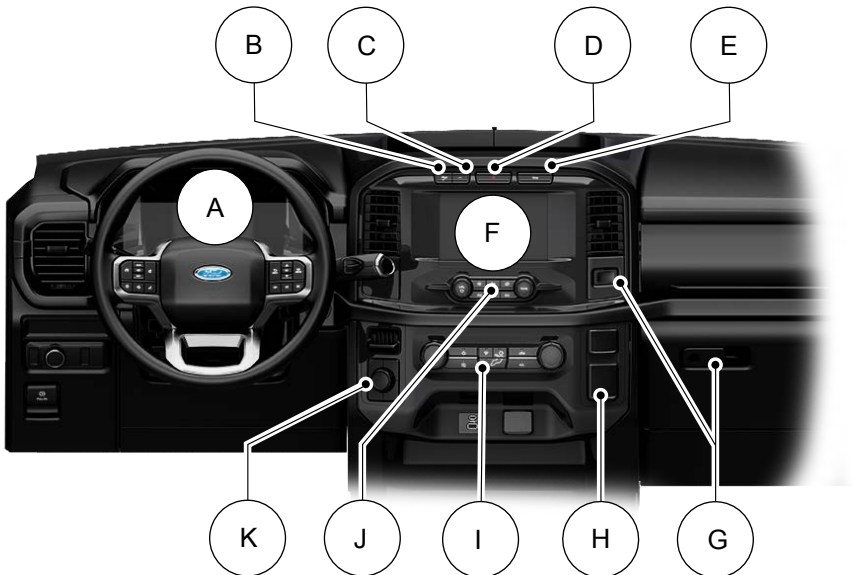

- A See **Instrument Cluster Overview** (page 168). See **Instrument Cluster Overview** (page 167). See **Instrument Cluster Overview** (page 166).
- B See **Switching Traction Control On and Off** (page 298).
- C See **Switching the 360 Degree Camera On and Off** (page 323).
- D See **Switching the Hazard Flashers On and Off** (page 464).
- E See **Switching Active Park Assist On and Off** (page 325).

Visual Search

- F See **Feature Bar** (page 615).
- G See **Opening the Glove Compartment** (page 227).
- H See **What Is the Power Outlet** (page 222).
- I See **Identifying the Climate Control Unit** (page 181). See **Identifying the Climate Control Unit** (page 186).
- J See **Identifying the Audio Unit** (page 603).
- K See **Selecting a Four-Wheel Drive Mode** (page 271).

VEHICLE INTERIOR

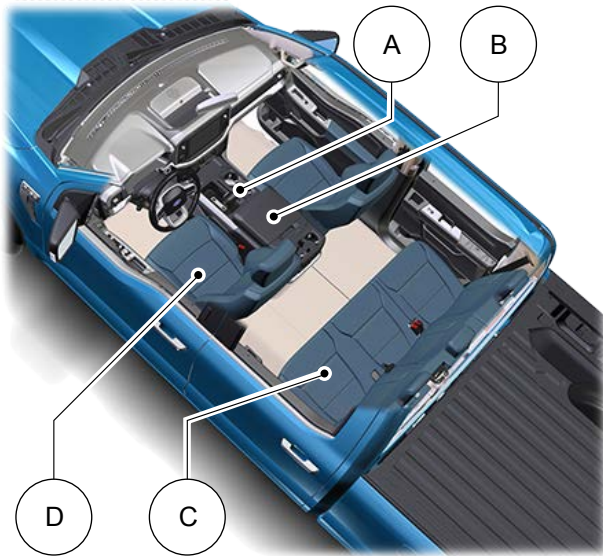

- A See **Shifting Using the Buttons on the Selector Lever** (page 263).
- B See **Using the Center Console Work Surface** (page 223). See **Using the Center Console Work Surface** (page 224).

Visual Search

- C See **Folding the Seats** (page 199).
- D See **Sitting in the Correct Position** (page 190).

VEHICLE INTERIOR - RAPTOR

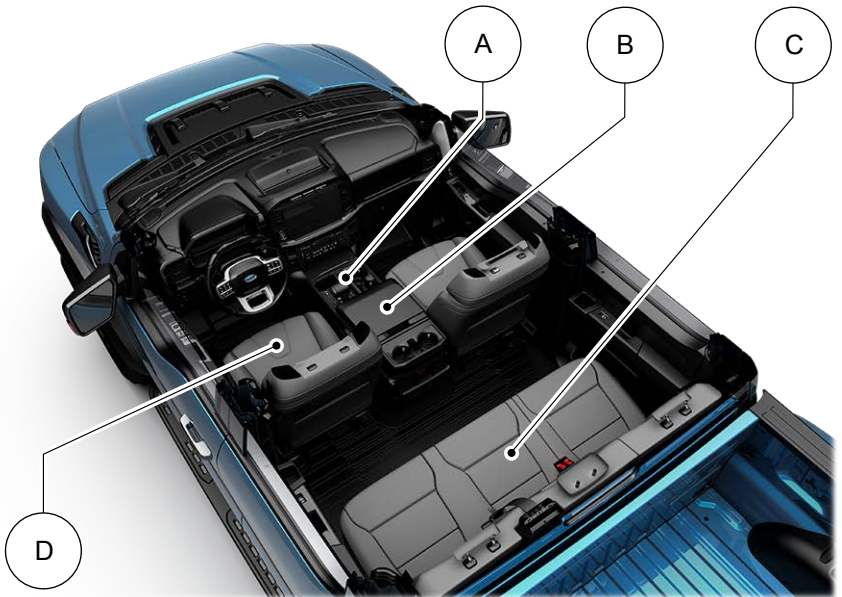

- A See **Stowing the Selector Lever** (page 266).
- B See **Using the Center Console Work Surface** (page 223). See **Using the Center Console Work Surface** (page 224).
- C See **Folding the Seats** (page 199).
- D See **Sitting in the Correct Position** (page 190).

Visual Search

VEHICLE INTERIOR - POLICE RESPONDER

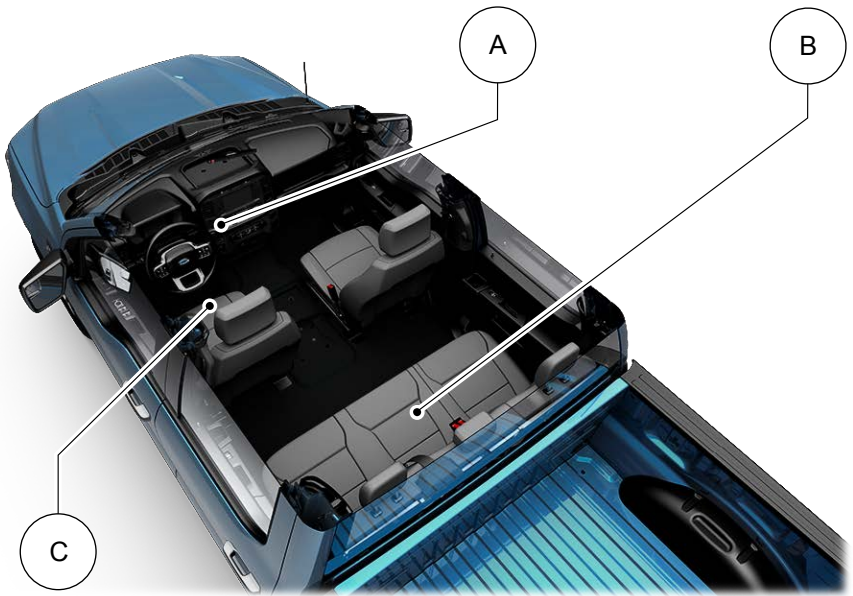

- A See **Shifting Your Vehicle Into Gear** (page 262).
- B See **Folding the Seats** (page 199).
- C See **Sitting in the Correct Position** (page 190).

Visual Search

FRONT EXTERIOR

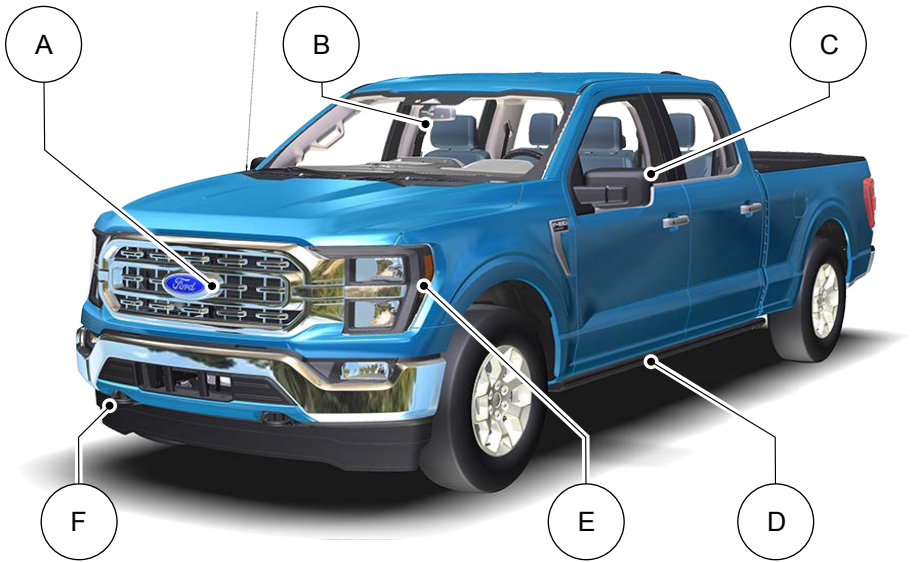

- A See **Locating the 360 Degree Cameras** (page 321).
- B See **What Is the Lane Keeping System** (page 361).
- C See **Folding the Exterior Mirrors** (page 162).
- D See **Deploying and Stowing the Power Running Boards** (page 137).
- E See **Exterior Lighting Control** (page 145).
- F See **Accessing the Front Towing Point** (page 467).

Visual Search

FRONT EXTERIOR - RAPTOR

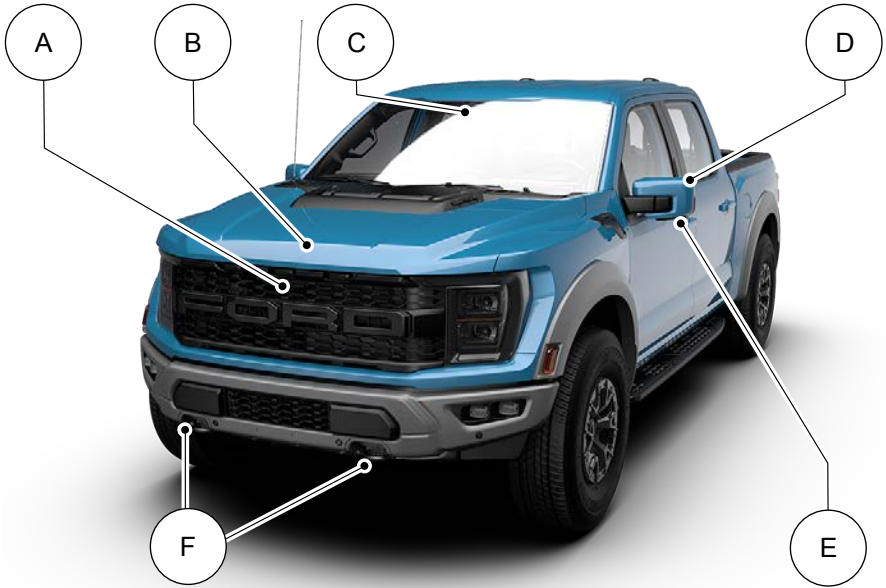

- A See **Locating the 360 Degree Cameras** (page 321).
- B See **Opening and Closing the Hood** (page 482).
- C See **How Does the Lane Keeping System Work** (page 361).
- D See **Folding the Exterior Mirrors** (page 162).
- E See **Locating the 360 Degree Cameras** (page 321).
- F See **Accessing the Front Towing Point** (page 467).

Visual Search

FRONT EXTERIOR - POLICE RESPONDER

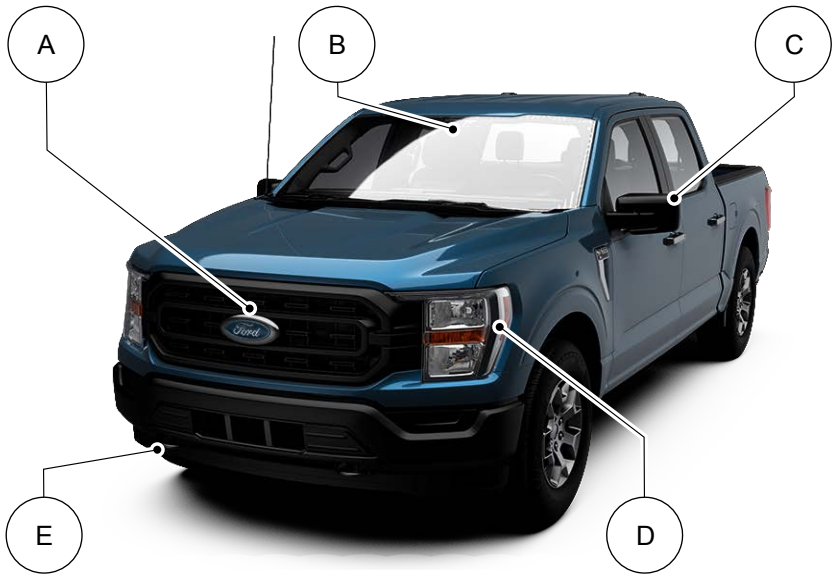

- A See **Locating the 360 Degree Cameras** (page 321).
- B See **What Is the Lane Keeping System** (page 361).
- C See **Folding the Exterior Mirrors** (page 162).
- D See **Exterior Lighting Control** (page 145).
- E See **Accessing the Front Towing Point** (page 467).

Visual Search

REAR EXTERIOR

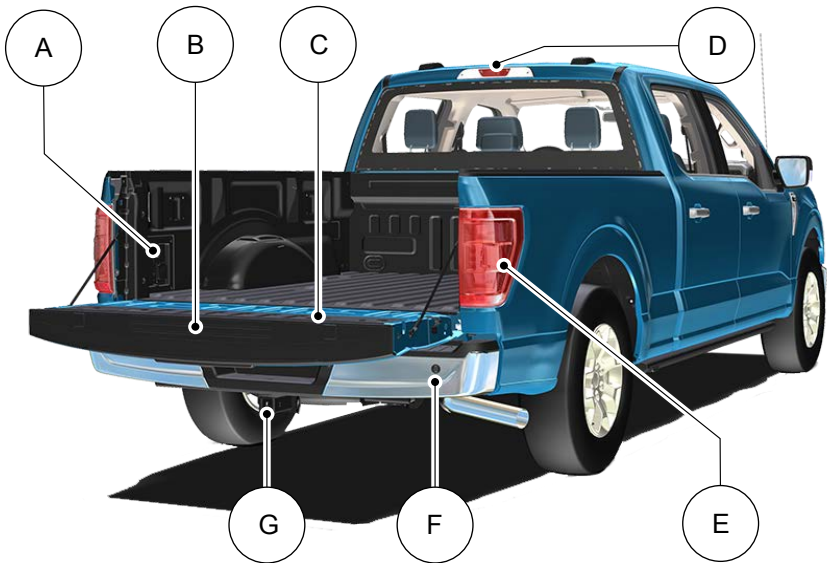

- A See **Locating the Power Outlets** (page 213).
- B See **Tailgate Work Surface** (page 122).
- C See **Accessing the Tailgate Step** (page 119).
- D See **Locating the 360 Degree Cameras** (page 321).
- E See **Locating the Blind Spot Information System Sensors** (page 369).
- F See **Locating the Rear Parking Aid Sensors** (page 314).
- G See **Connecting a Trailer** (page 399).

Visual Search

REAR EXTERIOR - RAPTOR

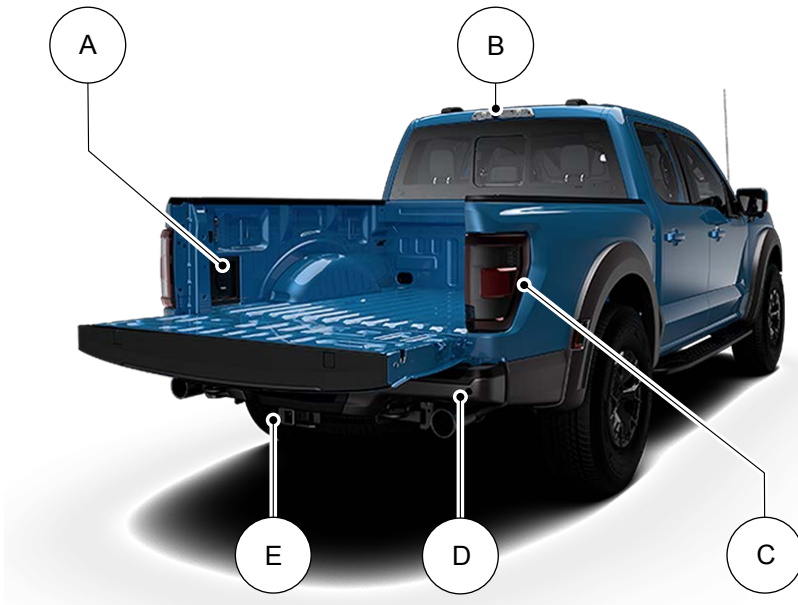

- A See **Locating the Power Outlets** (page 213).
- B See **Locating the 360 Degree Cameras** (page 322).
- C See **Locating the Blind Spot Information System Sensors** (page 369).
- D See **Locating the Rear Parking Aid Sensors** (page 314).
- E See **Connecting a Trailer** (page 399).

Visual Search

REAR EXTERIOR - POLICE RESPONDER

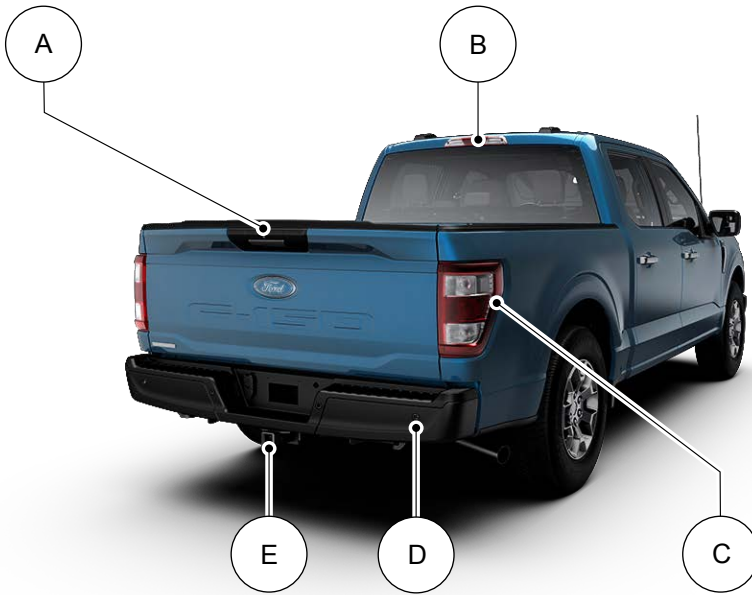

- A See **Opening the Tailgate From Outside Your Vehicle** (page 111). See **Opening the Tailgate From Outside Your Vehicle** (page 117). See **Opening the Tailgate From Outside Your Vehicle** (page 125).
- B See **Locating the 360 Degree Cameras** (page 321).
- C See **Locating the Blind Spot Information System Sensors** (page 369).
- D See **Locating the Rear Parking Aid Sensors** (page 314).
- E See **Connecting a Trailer** (page 399).

Child Safety

CHILD SAFETY PRECAUTIONS



WARNING: Always make sure your child is secured properly in a device that is appropriate for their height, age and weight. Child safety restraints must be bought separately from your vehicle. Failure to follow these instructions and guidelines may result in an increased risk of serious injury or death to your child.



WARNING: All children are shaped differently. The National Highway Traffic Safety Administration and other safety organizations, base their recommendations for child restraints on probable child height, age and weight thresholds, or on the minimum requirements of the law. We recommend that you check with a NHTSA Certified Child Passenger Safety Technician (CPST) to make sure that you properly install the child restraint in your vehicle and that you consult your pediatrician to make sure you have a child restraint appropriate for your child. To locate a child restraint fitting station and CPST, contact NHTSA toll free at 1-888-327-4236 or go to www.nhtsa.dot.gov. In Canada, contact Transport Canada toll free at 1-800-333-0371 or go to www.tc.gc.ca to find a Child Car Seat Clinic in your area. Failure to properly restrain children in child restraints made especially for their height, age and weight, may result in an increased risk of serious injury or death to your child.



WARNING: On hot days, the temperature inside the vehicle can rise very quickly. Exposure of people or animals to these high temperatures for even a short time can cause death or serious heat related injuries, including brain damage. Small children are particularly at risk.



WARNING: Do not place a rearward facing child restraint in front of an active airbag. Failure to follow this instruction could result in personal injury or death.



WARNING: Properly secure children 12 years old and under in a rear seating position whenever possible. If you are unable to properly secure all children in a rear seating position, properly secure the largest child on the front seat. If you must use a forward facing child restraint on the front seat, move the seat as far back as possible. Failure to follow these instructions could result in personal injury or death.



WARNING: Always carefully follow the instructions and warnings provided by the manufacturer of any child restraint to determine if the restraint device is appropriate for your child's size, height, weight, or age. Follow the child restraint manufacturer's instructions and warnings provided for installation and use in conjunction with the instructions and warnings provided by your vehicle manufacturer. A safety seat that is improperly installed or utilized, is inappropriate for your child's height, age, or weight or does not properly fit the child may increase the risk of serious injury or death.

Child Safety

WARNING: Do not allow a passenger to hold a child on their lap when your vehicle is moving. Failure to follow this instruction could result in personal injury or death in the event of a sudden stop or crash.

WARNING: Do not use pillows, books or towels to boost your child's height. Failure to follow this instruction could result in personal injury or death.

WARNING: Properly secure child restraints or booster seats when they are not in use. They could become projectiles in a sudden stop or crash. Failure to follow this instruction could result in personal injury or death.

WARNING: Do not put the shoulder section of the seatbelt or allow the child to put the shoulder section of the seatbelt under their arm or behind their back. Failure to follow this instruction could reduce the effectiveness of the seatbelt and increase the risk of injury or death in a crash.

WARNING: Do not leave children or pets unattended in your vehicle. Failure to follow this instruction could result in personal injury or death.

When installing a child restraint with seatbelts:

- Place the vehicle seat in the upright position before you install the child restraint.
- Use the correct seatbelt buckle for that seating position.
- Insert the belt tongue into the buckle. Make sure the tongue is securely fastened in the buckle.

- Keep the buckle release button pointing up and away from the child restraint, with the tongue between the child restraint and the release button, to prevent accidental unbuckling.
- Put the seatbelt in the automatic locking mode.

CHILD RESTRAINT ANCHOR POINTS

WHAT ARE THE CHILD RESTRAINT ANCHOR POINTS

Anchor points allow you to quickly and safely install a child restraint.

LOCATING THE CHILD RESTRAINT LOWER ANCHOR POINTS (If Equipped)

Crew Cab



Super Cab

Child Safety

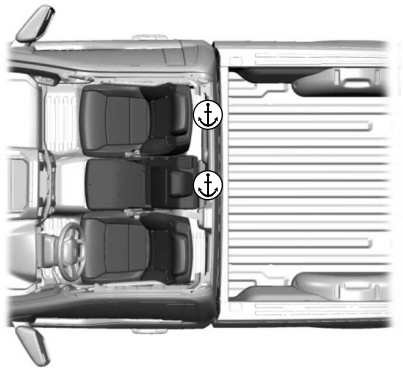
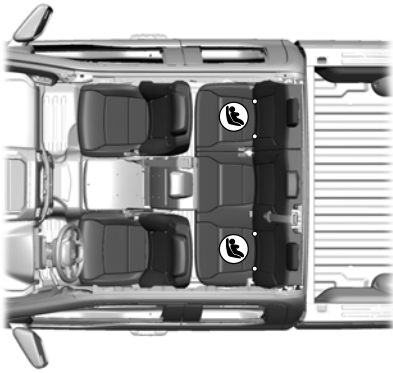

Crew Cab

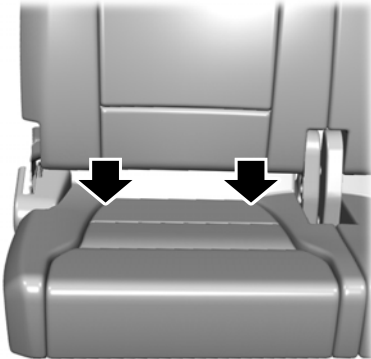

The lower child restraint anchors are at the rear section of the rear seat between the cushion and seat backrest.

Note: *Regular Cab vehicles do not have lower anchors.*

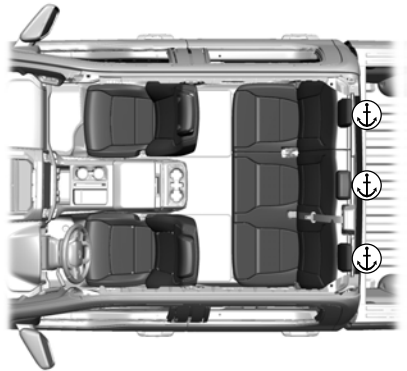

Super Cab

LOCATING THE CHILD RESTRAINT TOP TETHER ANCHOR POINTS

Regular Cab

Child Safety

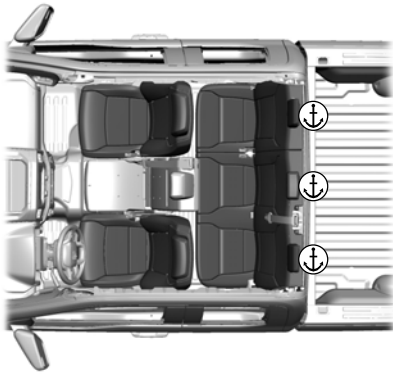

CHILD RESTRAINTS

CHILD RESTRAINT POSITION INFORMATION

Install the child restraint tightly against the vehicle seat. It may be necessary to lift or remove the head restraint.

Rear Facing Child Restraints

| Combined Weight of Child and Child Restraint | LATCH (Lower Anchors Only) | Seatbelt Only |
|--|----------------------------|---------------|
| Up to 65 lb (29 kg) | X | X |
| Over 65 lb (29 kg) | | X |

Forward Facing Child Restraints

| Combined Weight of Child and Child Restraint | LATCH (Lower Anchors and Top Tether Anchor) | Seatbelt and Top Tether Anchor | Seatbelt and LATCH (Lower Anchors and Top Tether Anchor) |
|--|---|--------------------------------|--|
| Up to 65 lb (29 kg) | X | X | X |
| Over 65 lb (29 kg) | | X | X |

Child Safety

CHILD RESTRAINTS RECOMMENDATION

| Child Size, Height, Weight, or Age | Recommended Restraint Type |
|---|---|
| Children weighing 40 lb (18 kg) or less (generally age four or younger). | Use a child restraint (sometimes called an infant carrier, convertible seat, or toddler seat). |
| Children who have outgrown or no longer properly fit in a child restraint (generally children who are less than 57 in (1.45 m) tall, are greater than age four and less than age 12, and between 40 lb (18 kg) and 80 lb (36 kg) and upward to 100 lb (45 kg) if recommended by your child restraint manufacturer). | Use a belt-positioning booster seat. |
| Children who have outgrown or no longer properly fit in a belt-positioning booster seat (generally children who are at least 57 in (1.45 m) tall or greater than 80 lb (36 kg) or 100 lb (45 kg) if recommended by child restraint manufacturer). | Use a vehicle seatbelt having the lap belt snug and low across the hips, shoulder belt centered across the shoulder and chest, and seat backrest upright. |

You are required by law to properly use child restraints for infants and toddlers in the United States, Canada and Mexico.

Many states and provinces require that small children use approved booster seats until they reach age eight, a height of 57 in (1.45 m) tall, or 80 lb (36 kg). Check your local and state or provincial laws for specific requirements about the safety of children in your vehicle.

When possible, properly restrain children 12 years of age and under in a rear seating position of your vehicle. Accident statistics suggest that children are safer when properly restrained in the rear seating positions than in a front seating position.

When installing a rear facing child restraint, adjust the vehicle seats to avoid interference between the child restraint and the vehicle seat in front of the child restraint.

INSTALLING CHILD RESTRAINTS

USING SEATBELTS



WARNING: Depending on where you secure a child restraint, and depending on the child restraint design, you may block access to certain seatbelt buckle assemblies and LATCH lower anchors, rendering those features potentially unusable. To avoid risk of injury, make sure occupants only use seating positions where they are able to be properly restrained.

Note: *The following does not apply to the front center position of Super Cab and Crew Cab vehicles.*

Note: *Although the child restraint illustrated is a forward facing child restraint, the steps are the same for installing a rear facing child restraint.*

Child Safety

Perform the following steps when installing a child restraint with seatbelts.

1. Position the child restraint in a seat with a seatbelt.



2. Pull down on the shoulder belt and then grasp the shoulder belt and lap belt together.



3. While holding the shoulder and lap belt portions together, route the tongue through the child restraint according to the child restraint manufacturer's instructions. Make sure you did not twist the belt webbing.

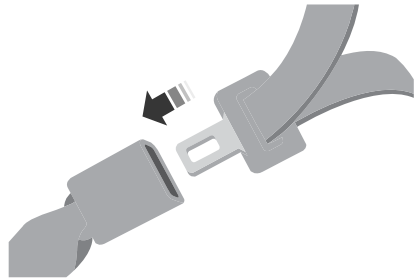

4. Insert the belt tongue into the proper buckle for that seating position until the latch engages. Make sure the tongue is latched securely by pulling on it.



5. To put the retractor in the automatic locking mode, grasp the shoulder portion of the belt and pull downward until you pull all of the seatbelt out.

Note: *The automatic locking mode is available on the front passenger and rear seats. This mode is also available on the center seat of a Regular Cab. This vehicle does not require the use of a locking clip.*

6. Allow the belt to retract to remove slack. The seatbelt clicks as it retracts to indicate it is in the automatic locking mode.

Child Safety

- Pull the seatbelt out of the retractor to make sure the retractor is in the automatic locking mode. You should not be able to pull more belt out. If the retractor is not locked, unbuckle the belt and repeat Steps 5 and 6.



- Remove remaining slack from the belt. Force the seat down with extra weight, for example, by pressing down or kneeling on the child restraint while pulling up on the shoulder belt in order to force slack from the belt. This is necessary to remove the remaining slack that exists once you add the extra weight of the child to the child restraint. It also helps to achieve the proper snugness of the child restraint to your vehicle. Sometimes, a slight lean toward the buckle helps to remove remaining slack from the belt.
- If the child restraint has a tether strap, attach it.

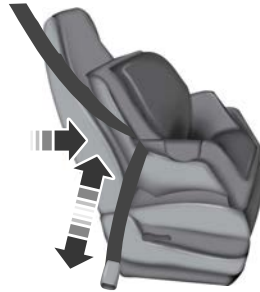

- Before placing the child in the seat, forcibly move the seat forward and back to make sure the seat is securely held in place.

To check this, grab the seat at the belt path and attempt to move it side to side and forward and back. There should be no more than 1 in (2.5 cm) of movement.

We recommend checking with a NHTSA Certified Child Passenger Safety Technician to make certain the child restraint is properly installed. In Canada, check with Transport Canada for referral to a Child Car Seat Clinic.

Using Seatbelts

 **WARNING:** Always use both the lap and shoulder portion of the seatbelt in the center seating position.

Note: *The following applies to the front center position of Super Cab and Crew Cab vehicles.*

The seatbelt webbing below the tongue is the lap portion of the seatbelt. The webbing above the tongue is the shoulder belt portion of the seatbelt.

- Position the child restraint in the front center seat.

Child Safety



2. Slide the tongue up the webbing.



3. While holding both shoulder and lap portions next to the tongue, route the tongue and webbing through the child restraint according to the child restraint manufacturer's instructions. Make sure you did not twist the belt webbing.

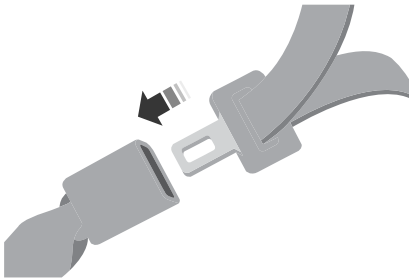

4. Insert the belt tongue into the proper buckle for that seating position until the latch engages. Make sure the tongue is latched securely by pulling on it.



5. When pushing down with your knee on the child restraint, pull up on the shoulder belt portion to tighten the lap belt portion of the seatbelt.
6. Allow the seatbelt to retract and remove any slack in the belt to securely tighten the child restraint in the vehicle.
7. If the child restraint has a tether strap, attach it.



Child Safety

8. Before placing the child in the seat, forcibly move the seat forward and back to make sure the seat is securely held in place. To check this, grab the seat at the belt path and attempt to move it side to side and forward and back. There should be no more than 1 in (2.5 cm) of movement.
 9. Check from time to time to be sure that there is no slack in the lap and shoulder belt. The shoulder belt must be snug to keep the lap belt tight during a crash.
- Two lower anchors where the vehicle seat backrest and seat cushion meet, called the seat bight.
 - One top tether anchor behind that seating position.

LATCH compatible child restraints have two rigid or webbing mounted attachments. These attachments connect to the two lower anchors at the LATCH equipped seating positions in your vehicle. This type of attachment method eliminates the need to use seatbelts to attach the child restraint.

We recommend checking with a NHTSA Certified Child Passenger Safety Technician to make certain the child restraint is properly installed. In Canada, check with Transport Canada for referral to a Child Car Seat Clinic.

However, you can still use the seatbelt to attach the child restraint if the lower anchors are not used. For forward-facing child restraints, you must also attach the top tether strap to the proper top tether anchor if a top tether strap has been provided with your child restraint.

USING LOWER ANCHORS AND TETHERS FOR CHILDREN

Follow the instructions later in this chapter on attaching child restraints with tether straps.



WARNING: Do not attach two child safety restraints to the same anchor. In a crash, one anchor may not be strong enough to hold two child safety restraint attachments and may break, causing serious injury or death.



WARNING: Depending on where you secure a child restraint, and depending on the child restraint design, you may block access to certain seatbelt buckle assemblies and LATCH lower anchors, rendering those features potentially unusable. To avoid risk of injury, make sure occupants only use seating positions where they are able to be properly restrained.

The Lower Anchors and Tethers for Children (LATCH) system has three vehicle anchor points:

INSTALLING A CHILD RESTRAINT IN A CENTER SEAT



WARNING: The standardized spacing for LATCH lower anchors is 11 in (280 mm) center to center. Do not use LATCH lower anchors for the center seating position unless the child restraint manufacturer's instructions permit and specify using anchors spaced at least as far apart as those in this vehicle.

The lower anchors at the center of the second row rear seat are spaced 25.7 in (652 mm) apart. The standardized spacing for LATCH lower anchors is 11 in (280 mm) center to center.

Child Safety

You cannot install a child restraint with rigid LATCH attachments at the center seating position. You can only use LATCH compatible child restraints with attachments on belt webbing at this seating position provided that the child restraint manufacturer's instructions permit use with the anchor spacing stated. Do not attach a child restraint to any lower anchor if another child restraint is attached to that anchor.

Each time you use the child restraint, check that the seat is properly attached to the lower anchors and tether anchor, if applicable. Tug the child restraint from side to side and forward and back where it is secured to the vehicle. The seat should move less than 1 in (2.5 cm).

If you did not properly anchor the child restraint, the risk of a child being injured in a crash greatly increases.

COMBINING THE SEATBELT AND LOWER ANCHORS FOR ATTACHING CHILD RESTRAINTS

When used in combination, you may attach either the seatbelt or the LATCH lower anchors first, provided a proper installation is achieved. Attach the tether strap afterward, if it is included with the child restraint.

USING TETHER STRAPS

Many forward-facing child restraints include a tether strap which extends from the back of the child restraint and hooks to an anchoring point called the top tether anchor. Tether straps are available as an accessory for many older child restraints.

Contact the manufacturer of your child restraint for information about ordering a tether strap, or to obtain a longer tether strap if the tether strap on your child restraint does not reach the appropriate top tether anchor in the vehicle.

Attach the tether strap only to the appropriate tether anchor. The tether strap may not work properly if attached somewhere other than the correct tether anchor.

If you install a child restraint with rigid LATCH attachments, do not tighten the tether strap enough to lift the child restraint off the vehicle seat cushion when the child is seated in it. Keep the tether strap just snug without lifting the front of the child restraint. Keeping the child restraint just touching the vehicle seat gives the best protection in a severe crash.

Once you have installed the child restraint using either the seatbelt, the lower anchors of the LATCH system, or both, you can attach the top tether strap.

ATTACHING THE FRONT SEAT TETHER STRAP

Regular Cab

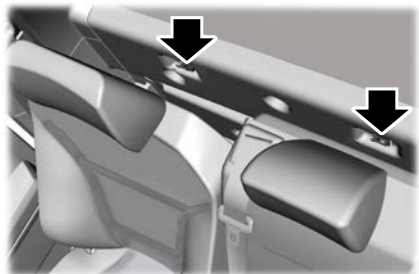

1. Route the child restraint tether strap over the back of the seat and under the head restraint.

Child Safety

Note: For vehicles with adjustable head restraints, route the tether strap under the head restraint and between the head restraint posts. Otherwise, route the tether strap over the top of the seat backrest.

2. Locate the correct anchor for the selected seating position. You may need to pull the seat backrest forward to access the tether anchors. Make sure the seat is locked in the upright position before installing the child restraint.
3. Clip the tether strap to the anchor.
4. Tighten the child restraint tether strap according to the manufacturer's instructions.

If you incorrectly clip the tether strap, the child restraint may not be retained properly in the event of a crash.

If you did not properly anchor the child restraint, the risk of a child being injured in a crash greatly increases.

If your child restraint system has a tether strap, and the child restraint manufacturer recommends its use, we also recommend its use.

ATTACHING THE REAR SEAT TETHER STRAP (If Equipped)

Crew Cab and Super Cab

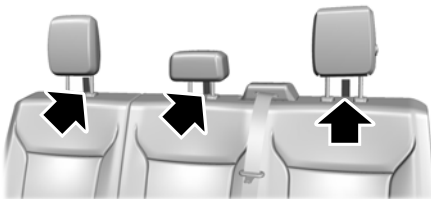

There are three loops of webbing above the back of the rear seat. Use these loops as routing loops and anchor loops for up to three child restraint tether straps.

For example, you can use the center loop as a routing loop for a child restraint in the center rear seat and as an anchoring loop for child restraints installed in the outermost rear seats.

Many tether straps cannot be tightened if the tether strap is hooked to the loop directly behind the child restraint.

To provide a tight tether strap:

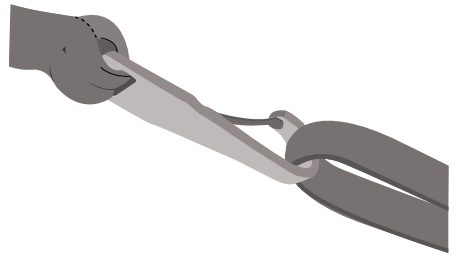

1. Route the vehicle tether loop between the head restraint posts, then route the child restraint tether strap through the loop, forward of the head restraint.
2. Hook the strap to the vehicle tether anchor loop in the adjacent seating position. If using the driver side, pass the strap behind the shoulder belt for the center seat. Put the tether strap through the routing loop. The head restraint support post holds the child restraint tightly, but the head restraint post is not strong enough to hold the child restraint during a crash.
3. Tighten the tether strap according to the child restraint manufacturer's instructions.

Child Safety

If you did not properly anchor the child restraint, the risk of a child being injured in a crash greatly increases.

If your child restraint system has a tether strap, and the child restraint manufacturer recommends its use, we also recommend its use.

BOOSTER SEATS

Use a belt-positioning booster seat for children who have outgrown or no longer properly fit in a child restraint and meet the following criteria.

- Generally children who are less than 57 in (1.45 m) tall.
- Are greater than age four (4) and less than age twelve (12).
- Are between 40 lb (18 kg) and 80 lb (36 kg) and upward to 100 lb (45 kg).

Many state and provincial laws require that children use approved booster seats until they reach age eight, a height of 57 in (1.45 m) tall, or 80 lb (36 kg).

Booster seats should be used until you can answer yes to all of these questions when seated without a booster seat:

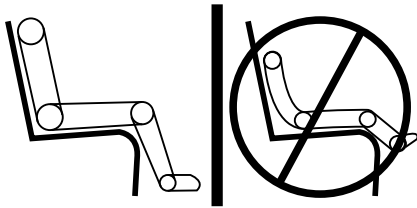

- Can the child sit all the way back against their vehicle seat backrest with knees bent comfortably at the edge of the seat cushion?
- Can the child sit without slouching?
- Does the lap belt rest low across the hips?
- Is the shoulder belt centered on the shoulder and chest?
- Can the child stay seated like this for the whole trip?

Always use booster seats in conjunction with your vehicle lap and shoulder belt.

Types of Booster Seats



- Backless booster seats

If your backless booster seat has a removable shield, remove the shield.

If a vehicle seating position has a low seat backrest or no head restraint, a backless booster seat may place your child's head, as measured at the tops of the ears, above the top of the seat. In this case, move the backless booster to another seating position with a higher seat backrest or head restraint and lap and shoulder belts, or consider using a high-back booster seat.

Child Safety



- High-back booster seats

If, with a backless booster seat, you cannot find a seating position that adequately supports your child's head, a high-back booster seat would be a better choice.

Children and booster seats vary in size and shape. Choose a booster that keeps the lap belt low and snug across the hips, never up across the stomach, and lets you adjust the shoulder belt to cross the chest and rest snugly near the center of the shoulder.

The following drawings compare the ideal fit to a shoulder belt uncomfortably close to the neck and a shoulder belt that could slip off the shoulder. The drawings also show how the lap belt should be low and snug across the child's hips.



Child Safety

If the booster seat slides on the vehicle seat upon which it is being used, placing a rubberized mesh sold as shelf or carpet liner under the booster seat may improve this condition. Do not use any item thicker than this under the booster seat. Check with the booster seat manufacturer's instructions.

Right-Hand Side

Turn the key counterclockwise to switch the child lock on and clockwise to switch it off.

CHILD SAFETY LOCKS (IF EQUIPPED)



WARNING: You cannot open the rear doors from inside if you have put the child safety locks on.



A child safety lock is on the rear edge of each rear door. You must switch the child safety lock separately on each door.

Left-Hand Side

Turn the key clockwise to switch the child lock on and counterclockwise to switch it off.

Seatbelts

SEATBELT PRECAUTIONS



WARNING: Always drive and ride with your seatback upright and the lap belt snug and low across the hips.



WARNING: Children must always be properly restrained.



WARNING: Do not allow a passenger to hold a child on their lap when your vehicle is moving. Failure to follow this instruction could result in personal injury or death in the event of a sudden stop or crash.



WARNING: All occupants of your vehicle, including the driver, should always properly wear their seatbelts, even when an airbag supplemental restraint system is provided. Failure to properly wear your seatbelt could seriously increase the risk of injury or death.



WARNING: It is extremely dangerous to ride in a cargo area, inside or outside of a vehicle. In a crash, people riding in these areas are more likely to be seriously injured or killed. Do not allow people to ride in any area of your vehicle that is not equipped with seats and seatbelts. Make sure everyone in your vehicle is in a seat and properly using a seatbelt. Failure to follow this warning could result in serious personal injury or death.



WARNING: In a rollover crash, an unbelted person is significantly more likely to die than a person wearing a seatbelt.



WARNING: Each seating position in your vehicle has a specific seatbelt assembly made up of one buckle and one tongue designed to be used as a pair. Use the shoulder belt on the outside shoulder only. Never wear the shoulder belt under the arm. Never use a single seatbelt for more than one person.



WARNING: Even with advanced restraints systems, properly restrain children 12 and under in a rear seating position. Failure to follow this could seriously increase the risk of injury or death.



WARNING: Seatbelts and seats may be hot in a vehicle that is in the sunshine. The hot seatbelts or seats may burn a small child. Check seat covers and buckles before you place a child anywhere near them.



WARNING: If your vehicle is involved in a crash, have the seatbelts and associated components inspected as soon as possible. Failure to follow this instruction could result in personal injury or death.

All seating positions in this vehicle have seatbelts. All occupants of the vehicle should properly wear their seatbelts, even when an airbag supplemental restraint system is provided.

The seatbelt system consists of:

- Lap and shoulder seatbelts.
- A shoulder seatbelt with automatic locking mode, except driver seatbelt.
- Height adjusters at the front outermost seating positions.
- Seatbelt pretensioners at the front outermost and rear outermost seating positions.

Seatbelts



A seatbelt warning light and chime.



Crash sensors and monitoring system with readiness indicator.

The seatbelt pretensioners are designed to tighten the seatbelts when activated. In frontal and near-frontal crashes, the seatbelt pretensioners may be activated alone or, if the crash is of sufficient severity, together with the front airbags. In side crashes and rollovers, the pretensioners will be activated when the Safety Canopy is activated.

FASTENING AND UNFASTENING THE SEATBELTS

This applies to all seating positions, except for the front center position of Super Cab and Crew Cab.

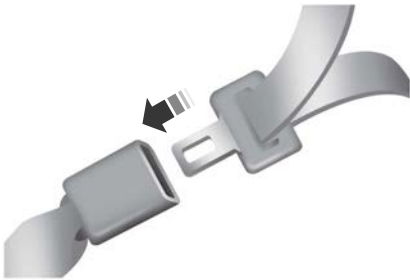

1. Insert the seatbelt tongue into the buckle until you hear a snap and feel it latch.

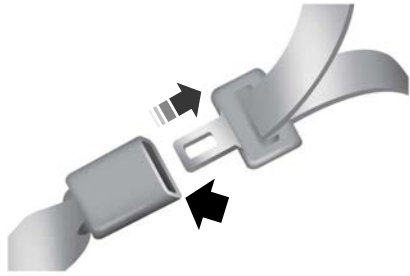

2. Press the button to release the seatbelt.

Using the Seatbelt With Cinch Tongue

This applies to the front center seating position of Super Cab and Crew Cab.

The cinch tongue slides up and down the seatbelt webbing when you stow the seatbelt or when you put the seatbelts on. When you buckle the seatbelt, the cinch tongue allows you to shorten the lap portion, but pinches the webbing to keep the lap portion from getting longer. The cinch tongue is designed to slip during a crash, so wear the shoulder belt properly and do not allow any slack in either the lap or shoulder portions.

Fastening the Cinch Tongue



WARNING: Always drive and ride with your seatback upright and the lap belt snug and low across the hips.

1. Pull the seatbelt from the retractor so that the shoulder belt portion of the seatbelt crosses your shoulder and chest.
2. Make sure the belt is not twisted. If the belt is twisted, remove the twist.

Seatbelts

3. Insert the belt tongue into the proper buckle for your seating position until you hear a snap and feel it latch.
4. Make sure you securely fasten the tongue to the buckle by pulling on the tongue.

While you are fastened in the seatbelt, the seatbelt with a cinch tongue adjusts to your movement. However, if you brake hard, turn hard, or if your vehicle receives an impact of 5 mph (8 km/h) or more, the seatbelt locks and helps reduce your forward movement.

SENSITIVE LOCKING MODE

WHAT IS SENSITIVE LOCKING MODE

Sensitive locking mode is a seatbelt retractor feature that allows shoulder belt length adjustment according to your movements and locking in response to vehicle movement.

HOW DOES SENSITIVE LOCKING MODE WORK

If the driver suddenly brakes, turns a corner sharply, or the vehicle receives an impact of about 5 mph (8 km/h) or more, the seatbelts lock to help reduce forward movement of the driver and passengers.

In addition, the seatbelt retractor locks if you pull the seatbelt webbing out too quickly. If the retractor locks, slowly lower the height adjuster to allow the seatbelt to retract.

If the retractor does not unlock, pull the seatbelt out slowly then feed a small length of webbing back toward the stowed position.

For rear seatbelts, recline the rear seat backrest or push the seat backrest cushion away from the seatbelt. Feed a small length of webbing back toward the stowed position.

AUTOMATIC LOCKING MODE

WHAT IS AUTOMATIC LOCKING MODE

This feature keeps the seatbelts pre-locked. The belt still retracts to remove any slack in the shoulder belt.

WHEN TO USE AUTOMATIC LOCKING MODE

Use this mode any time you install a child restraint in a front seating position in a Regular Cab, Super Cab, Crew Cab or any rear seating position of a Super Cab or Crew Cab. The optional front seat center seatbelt in the Super Cab and Crew Cab has a cinch mechanism. Properly restrain children 12 years old and under in a rear seat whenever possible. See **Child Safety** (page 47).

Note: *Automatic locking mode is not available on the driver seatbelt.*

Seatbelts

ENGAGING AUTOMATIC LOCKING MODE



1. Fasten the combination lap and shoulder belt.
2. Grasp the shoulder portion and pull downward until you pull the entire belt out.
3. Allow the belt to retract. As the belt retracts, you will hear a clicking sound. This indicates the seatbelt is now in the automatic locking mode.

DISENGAGING AUTOMATIC LOCKING MODE

Unbuckle the combination lap and shoulder belt and allow it to retract completely to disengage the automatic locking mode and activate the vehicle sensitive locking mode.

ADJUSTING THE SEATBELTS DURING PREGNANCY



WARNING: Always ride and drive with your seatback upright and properly fasten your seatbelt. Fit the lap portion of the seatbelt snugly and low across the hips. Position the shoulder portion of the seatbelt across your chest. Pregnant women must follow this practice. See the following figure.

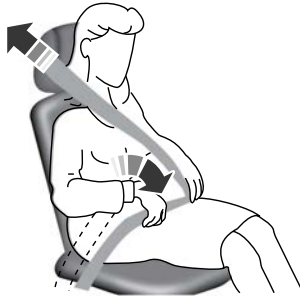

Pregnant women should always wear their seatbelt. Position the lap belt portion of a combination lap and shoulder belt low across the hips below the belly and worn as tight as comfort allows. Position the shoulder belt to cross the middle of the shoulder and the center of the chest.

ADJUSTING THE SEATBELT HEIGHT



WARNING: Position the seatbelt height adjuster so that the seatbelt rests across the middle of your shoulder. Failure to adjust the seatbelt correctly could reduce its effectiveness and increase the risk of injury in a crash.

Seatbelts

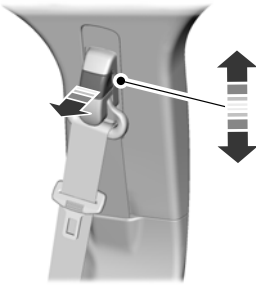

1. Pull the button and slide the height adjuster up or down.
2. Release the button and pull down on the height adjuster and pull down on the height adjuster to make sure it is locked in place.

ADJUSTING THE SEATBELT LENGTH



1. Pull some seatbelt webbing out of the shoulder belt retractor.
2. While holding the webbing below the tongue, grasp the metal tip of the tongue so that it is parallel to the webbing and slide the tongue up.
3. Provide enough lap belt length so that the tongue can reach the buckle.

SEATBELT REMINDER

HOW DOES THE SEATBELT REMINDER WORK

This feature supplements the seatbelt warning function by providing additional reminders that intermittently sound a tone and illuminate the seatbelt warning lamp when you are in the driver seat or you have a front seat passenger and a seatbelt is unbuckled.

The system uses information from the front passenger sensing system to determine if a front seat passenger is present and therefore potentially in need of a warning. To avoid the system switching on the Belt-Minder feature for objects you place on the front passenger seat, only the front seat passengers receive warnings as determined by the front passenger sensing system.

If the Belt-Minder warnings expire (warnings for about five minutes) for one passenger (driver or front passenger), the other passenger can still cause the Belt-Minder feature to switch on.

Seatbelts

| If | Then |
|--|--|
| You and the front seat passenger buckle your seatbelts before you switch the ignition on or less than 1–2 minutes elapse after you switch the ignition on... | The Belt-Minder feature will not activate. |
| You or the front seat passenger do not buckle your seatbelts before your vehicle reaches at least 6.0 mph (9.7 km/h) and 1–2 minutes elapse after you switch the ignition on... | The Belt-Minder feature activates, the seatbelt warning lamp illuminates and an indicator tone sounds for 6 seconds every 25 seconds, repeating for about 5 minutes or until you and the front seat passenger buckle your seatbelts. |
| The seatbelt for the driver or front passenger is unbuckled for about 1 minute while the vehicle is traveling at least 6.0 mph (9.7 km/h) and more than 1–2 minutes elapse after you switch the ignition on... | The Belt-Minder feature activates, the seatbelt warning lamp illuminates and an indicator tone sounds for 6 seconds every 25 seconds, repeating for about 5 minutes or until you and the front seat passenger buckle your seatbelts. |

Seatbelts

SEATBELT REMINDER INDICATORS

A warning lamp illuminates if the ignition is on, a front seat is occupied and the seatbelt has not been fastened.



The warning lamp illuminates until you fasten your seatbelt.

SEATBELT REMINDER AUDIBLE WARNINGS

A warning tone sounds if the warning lamp illuminates and your vehicle exceeds a relatively low speed.

The warning tone sounds for up to five minutes or until you fasten your seatbelt.

SWITCHING THE SEATBELT REMINDER ON AND OFF



WARNING: While the system allows you to deactivate it, this system is designed to improve your chances of being safely belted and surviving an accident. We recommend you leave the system activated for yourself and others who may use the vehicle.

Note: The driver and front passenger warnings switch off independently. When you perform this procedure for one seating position, do not buckle the other position as this cancels the process.

Note: If you are using MyKey, you cannot disable the seatbelt reminder. Also, if the seatbelt reminder has been previously disabled, it will be re-enabled during the use of MyKey. See **MyKey™** (page 96).

Read Steps 1 - 4 before proceeding with the programming procedure.

Make sure that:

- The parking brake is set.
 - The transmission is in park (P).
 - The ignition is off.
 - The driver and front passenger seatbelts are unfastened.
1. Switch the ignition on. Do not start the engine.
 2. Wait about one minute until the seatbelt warning light switches off. After Step 2, wait an additional five seconds before proceeding with Step 3. Once you start Step 3, you must complete the procedure within 30 seconds.
 3. For the seating position you are switching off, buckle then unbuckle the seatbelt three times at a moderate speed, ending in the unbuckled state. After Step 3, the seatbelt warning light switches on.
 4. When the seatbelt warning light is on, buckle then unbuckle the seatbelt. After Step 4, the seatbelt warning light flashes for confirmation.

This switches the feature off for that seating position if it is currently on.

This switches the feature on for that seating position if it is currently off.

CHECKING THE SEATBELTS

Check the seatbelts and child restraints periodically to make sure they work properly and are not damaged. Make sure there are no nicks, tears or cuts. Replace if necessary.

Check the following seatbelt assemblies after a crash.

- Retractors.
- Buckles.
- Front seatbelt buckle assemblies.

Seatbelts

- Shoulder belt height adjusters.
- Shoulder belt guide on seat backrest.
- Child restraint LATCH and tether anchors.
- Attaching hardware.

Read the child restraint manufacturer's instructions for additional inspection and maintenance information specific to the child restraint.

We recommend that all seatbelt assemblies in use in vehicles involved in a crash be replaced. However, if the crash was minor and an authorized dealer finds that the belts do not show damage and continue to operate properly, they do not need to be replaced. Seatbelt assemblies not in use during a crash should also be checked and replaced if either damage or improper operation is noted.

Properly care for seatbelts. See **Cleaning Seatbelts** (page 515).



WARNING: Do not use extensions to change the way the seatbelt fits across the torso, over the lap or to make the seatbelt buckle easier to reach.

If, because of body size or driving position, it is not possible to properly fasten the seatbelt over your lap and shoulder, an extension that is compatible with the seatbelts is available free of charge from our dealers. Only use our seatbelt extensions made by the original equipment seatbelt manufacturer with our seatbelts. Ask your authorized dealer if your extension is compatible with your vehicle restraint system.

SEATBELT EXTENSIONS



WARNING: Persons who fit into the vehicle's seatbelt should not use an extension. Unnecessary use could result in serious personal injury in the event of a crash.



WARNING: Only use extensions provided free of charge by our dealers. The dealer will provide an extension designed specifically for this vehicle, model year and seating position. The use of an extension intended for another vehicle, model year or seating position may not offer you the full protection of your vehicle's seatbelt restraint system.



WARNING: Never use seatbelt extensions to install child restraints.

Personal Safety System™

WHAT IS THE PERSONAL SAFETY SYSTEM

An advanced safety system that protects occupants in frontal crashes.

HOW DOES THE PERSONAL SAFETY SYSTEM WORK

This system provides an improved level of frontal crash protection to front seat occupants and is designed to reduce the risk of airbag-related injuries. The system analyzes occupant conditions and crash severity before activating the appropriate safety devices. During a crash, the restraints control module may deploy the seatbelt pretensioners, and one or both stages of the dual-stage airbags based on crash severity and occupant conditions.

PERSONAL SAFETY SYSTEM COMPONENTS

- Driver and passenger dual-stage airbag supplemental restraints.
- Front seat outermost seatbelts with pretensioners, energy management retractors and seatbelt usage sensors.
- Front passenger sensing system.
- Passenger airbag off and on indicators.
- Front crash severity sensors.
- Restraints control module with impact and safing sensors.
- Restraint system warning light and tone.
- The electrical wiring for the airbags, crash sensors, seatbelt pretensioners, front seatbelt usage sensors, front passenger sensing system and indicator lights.

Airbags

HOW DO THE FRONT AIRBAGS WORK

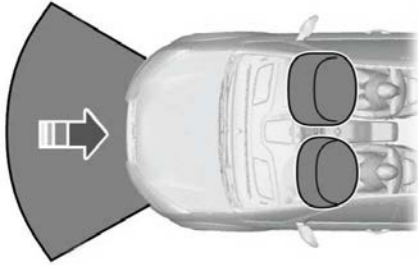

The driver and front passenger airbags deploy during significant frontal and near frontal crashes.

The driver and passenger front airbag system consists of:

- Driver and passenger airbag modules.
- Front passenger sensing system.
- Crash sensors and monitoring system with readiness indicator. See **Crash Sensors and Airbag Indicator** (page 77).

The airbags are a supplemental restraint system and are designed to work with the seatbelts to help protect the driver and right front passenger from certain upper body injuries. Airbags do not inflate slowly; there is a risk of injury from a deploying airbag.

Note: *You will hear a loud bang and see a cloud of harmless powdery residue if an airbag deploys. This is normal.*

The airbags inflate and deflate rapidly upon activation. After airbag deployment, it is normal to notice a smoke-like, powdery residue or smell the burnt propellant. This may consist of cornstarch, talcum powder (to lubricate the bag) or sodium

compounds (for example, baking soda) that result from the combustion process that inflates the airbag. Small amounts of sodium hydroxide may be present which may irritate the skin and eyes, but none of the residue is toxic.

Contact with a deploying airbag may cause abrasions or swelling. Temporary hearing loss is also a possibility as a result of the noise associated with a deploying airbag.

Because airbags must inflate rapidly and with considerable force, there is the risk of death or serious injuries such as fractures, facial and eye injuries or internal injuries, particularly to occupants who are not properly restrained or are otherwise out of position at the time of airbag deployment. Thus, it is extremely important that occupants be properly restrained as far away from the airbag module as possible while maintaining vehicle control.

Routine maintenance of the airbags is not required.

HOW DO THE SIDE AIRBAGS WORK



WARNING: Do not place objects or mount equipment on or near the airbag cover, on the side of the front or rear seatbacks, or in areas that may come into contact with a deploying airbag. Failure to follow these instructions may increase the risk of personal injury in the event of a crash.



WARNING: Accessory seat covers not released by Ford Motor Company could prevent the deployment of the airbags and increase the risk of injuries in a crash.

Airbags



WARNING: Do not lean your head on the door. The side airbag could injure you as it deploys from the side of the seatback.

The side airbags are on the outermost side of the seat backrests of the front seats. In certain sideways crashes or rollovers, the airbags will be inflated. The airbag was designed to inflate between the door panel and occupant to further enhance the protection provided to occupants in side impact crashes.



The system consists of the following:

- A label or embossed side panel indicating that side airbags are fitted to your vehicle.
- Side airbags inside the driver and front passenger seat backrests.
- Crash sensors and monitoring system with readiness indicator. See **Crash Sensors and Airbag Indicator** (page 77).

HOW DO THE KNEE AIRBAGS WORK

Driver and passenger knee airbags are under or within the instrument panel. During a crash, the restraints control module may activate the driver and passenger knee airbags (individually or both) based on crash severity and respective occupant conditions. Under certain crash and occupant conditions, the driver and passenger knee airbags may deploy (individually or both) but the corresponding front airbag may not activate. It is important to be properly seated and restrained to reduce the risk of death or serious injury.



Make sure the knee airbags are operating properly. See **Crash Sensors and Airbag Indicator** (page 77).

HOW DOES THE SAFETY CANOPY™ WORK



WARNING: Do not place objects or mount equipment on or near the headliner at the siderail that may come into contact with a deploying curtain airbag. Failure to follow these instructions may increase the risk of personal injury in the event of a crash.



WARNING: Do not lean your head on the door. The curtain airbag could injure you as it deploys from the headliner.



WARNING: To reduce risk of injury, do not obstruct or place objects in the deployment path of the airbag.

Airbags

The Safety Canopy deploys during significant side crashes or when a certain likelihood of a rollover event is detected by the rollover sensor. The Safety Canopy is mounted to the roof side-rail sheet metal, behind the headliner, above each row of seats. In certain sideways crashes or rollover events, the Safety Canopy will be activated, regardless of which seats are occupied. The Safety Canopy inflates between the side window area and occupants to further enhance protection provided in side impact crashes and rollover events.

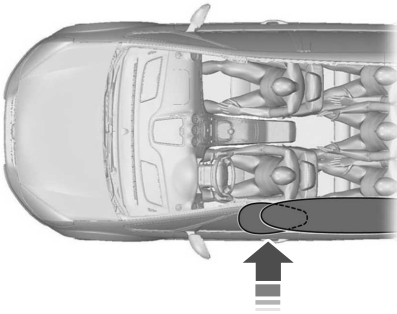

The system consists of the following:

- Safety Canopy curtain airbags above the trim panels over the front and rear side windows identified by a label or wording on the headliner or roof-pillar trim.
- A flexible headliner which opens above the side doors to allow air curtain deployment



• Crash sensors and monitoring system with a readiness indicator. See **Crash Sensors and Airbag Indicator** (page 77).

Properly restrain children 12 years old and under in the rear seats. The Safety Canopy will not interfere with children restrained using a properly installed child or booster seat because it is designed to inflate downward from the headliner above the doors along the side window opening.

AIRBAG PRECAUTIONS



WARNING: Airbags do not inflate slowly or gently, and the risk of injury from a deploying airbag is the greatest close to the trim covering the airbag module.



WARNING: All occupants of your vehicle, including the driver, should always properly wear their seatbelts, even when an airbag supplemental restraint system is provided. Failure to properly wear your seatbelt could seriously increase the risk of injury or death.



WARNING: Properly secure children 12 years old and under in a rear seating position whenever possible. If you are unable to properly secure all children in a rear seating position, properly secure the largest child on the front seat. If you must use a forward facing child restraint on the front seat, move the seat as far back as possible. Failure to follow these instructions could result in personal injury or death.



WARNING: Do not place your arms on the airbag cover or through the steering wheel. Failure to follow this instruction could result in personal injury.

Airbags



WARNING: Keep the areas in front of the airbags free from obstruction. Do not affix anything to or over the airbag covers. Objects could become projectiles during airbag deployment. Failure to follow this instruction could result in personal injury or death.



WARNING: To reduce risk of injury, do not obstruct or place objects in the deployment path of the airbag.



WARNING: Do not place a rearward facing child restraint in front of an active airbag. Failure to follow this instruction could result in personal injury or death.



WARNING: Do not attempt to service, repair, or modify the supplementary restraint system or associated components. Failure to follow this instruction could result in personal injury or death.



WARNING: Several airbag system components get hot after inflation. To reduce the risk of injury, do not touch them after inflation.



WARNING: If a supplementary restraint system component has deployed, it will not function again. Have the system and associated components inspected as soon as possible. Failure to follow this instruction could result in personal injury or death.

PROPERLY ADJUSTING THE DRIVER AND FRONT PASSENGER SEATS



WARNING: National Highway Traffic Safety Administration (NHTSA) recommends a minimum distance of at least 10 in (25 cm) between an occupant's chest and the driver airbag module.

To properly position yourself away from the airbag:

- Move your seat to the rear as far as you can while still reaching the pedals comfortably.
- Recline the seat slightly one or two degrees from the upright position.

After all occupants have adjusted their seats and put on seatbelts, it is very important that they continue to sit properly. Properly seated occupants sit upright, lean against the seat backrest, and center themselves on the seat cushion, with their feet comfortably extended on the floor. Sitting improperly can increase the chance of injury in a crash event. For example, if an occupant slouches, lies down, turns sideways, sits forward, leans forward or sideways, or puts one or both feet up, the chance of injury during a crash greatly increases.

CHILDREN AND AIRBAGS



WARNING: Do not place a rearward facing child restraint in front of an active airbag. Failure to follow this instruction could result in personal injury or death.

Airbags



HOW DOES THE FRONT PASSENGER SENSING SYSTEM WORK

The system uses a passenger airbag status indicator which illuminates indicating that the front passenger frontal airbag is either enabled or disabled.

Note: When you first switch the ignition on, the passenger airbag status indicator off and on lamps illuminate for a short period to confirm they are functional.

Children must always be properly restrained. Accident statistics suggest that children are safer when properly restrained in the rear seating positions than in the front seating position. Failure to follow these instructions may increase the risk of injury in a crash.

If two adults and a child occupy a vehicle without rear seats, properly restrain the child in the center front seat unless doing so would interfere with driving your vehicle. This provides lap and shoulder belt protection for all occupants, and airbag protection for the adults. A child or infant properly restrained in the center front seat should have a reduced risk to serious injury from the airbags.

FRONT PASSENGER SENSING SYSTEM

WHAT IS THE FRONT PASSENGER SENSING SYSTEM

This system detects a properly seated occupant and determines if the front passenger airbag should be enabled.



The indicator lamps are in the overhead console.

The front passenger sensing system is designed to disable the front passenger frontal airbag under these conditions:

- The front passenger seat is unoccupied.
- The system determines an infant is present in a child restraint.
- A passenger takes their weight off of the seat for a period of time.
- If there is a problem with the airbag system or the passenger sensing system.

Even with this technology, parents are strongly encouraged to always properly restrain children in the rear seat.

Airbags

- When the front passenger sensing system disables the front passenger frontal airbag, the passenger airbag status indicator illuminates the off lamp.
- If you have installed the child restraint and the passenger airbag status indicator illuminates the on lamp, switch your vehicle off, remove the child restraint from your vehicle and reinstall the restraint following the child restraint manufacturer's instructions.

The front passenger sensing system works with sensors that are part of the front passenger seat and seatbelt. The sensors are designed to detect the presence of a properly seated occupant and determine if the front passenger frontal airbag should be enabled.

- When the front passenger sensing system enables the front passenger frontal airbag, the passenger airbag status indicator illuminates the on lamp.

If a person of adult size is sitting in the front passenger seat, but the passenger airbag status indicator off lamp is illuminated, it is possible that the person is not sitting properly in the seat. If this happens:

- Switch your vehicle off and ask the person to place the seat backrest in an upright position.
- Have the person sit upright in the seat, centered on the seat cushion, with the person's legs comfortably extended.
- Restart your vehicle and have the person remain in this position for about two minutes. This allows the system to detect that person and enable the passenger frontal airbag.
- If the indicator off lamp remains illuminated even after this, you should advise the person to ride in the rear seat.

After all occupants have adjusted their seats and put on seatbelts, it is very important that they continue to sit upright, leaning against the seat backrest, and centered on the seat cushion, with their feet comfortably extended on the floor.

Sitting improperly can increase the chance of injury in a crash event. For example, if an occupant slouches, lies down, turns sideways, sits forward, leans forward or sideways, or puts one or both feet up, the chance of injury during a crash greatly increases.

If you think that the state of the passenger airbag status indicator lamp is incorrect, check for the following:

- Objects lodged underneath the seat.
- Objects between the seat cushion and the center console.
- Objects hanging off the seat backrest.
- Objects stowed in the seat backrest map pocket.
- Objects placed on the occupant's lap.
- Cargo interference with the seat
- Other passengers pushing or pulling on the seat.
- Rear passenger feet and knees resting or pushing on the seat.

The listed conditions could cause the weight of a properly seated occupant to be incorrectly interpreted by the front passenger sensing system. The person in the front passenger seat could appear heavier or lighter due to the conditions listed.



Make sure the front passenger sensing system is operating properly. See **Crash Sensors and Airbag Indicator** (page 77).

If the airbag readiness light is on, do the following:

Airbags

- Pull your vehicle over.
- Switch your vehicle off.
- Check for any objects lodged underneath the front passenger seat or cargo interfering with the seat.
- Remove the obstruction if found.
- Restart your vehicle.
- Wait at least two minutes and verify that the airbag readiness light in the instrument cluster is no longer illuminated.
- If the airbag readiness light in the instrument cluster remains illuminated, there may be a problem due to the front passenger sensing system.

Do not attempt to repair or service the system. Take your vehicle in for service immediately.

If it is necessary to modify an advanced front airbag system to accommodate a person with disabilities, contact your Customer Relationship Center. See **Contacting Us** (page 20).

FRONT PASSENGER SENSING SYSTEM PRECAUTIONS



WARNING: Sitting improperly, out of position or with the seatback reclined too far can take weight off the seat cushion and affect the decision of the passenger sensing system, resulting in serious injury or death in the event of a crash. Always sit upright against your seat back, with your feet on the floor.



WARNING: Any alteration or modification to the front passenger seat may affect the performance of the front passenger sensing system. This could seriously increase the risk of injury or death.

FRONT PASSENGER SENSING SYSTEM INDICATORS

| Occupant | Passenger Airbag Status Indicator | Passenger Airbag |
|----------|-----------------------------------|------------------|
| Empty | OFF: Illuminated | Disabled |
| | ON: Not Illuminated | |
| Child | OFF: Illuminated | Disabled |
| | ON: Not Illuminated | |
| Adult | OFF: Not Illuminated | Enabled |
| | ON: Illuminated | |

Airbags

CRASH SENSORS AND AIRBAG INDICATOR



WARNING: Modifying or adding equipment to the front of your vehicle could affect the performance of the airbag system, increasing the risk of injury. This includes the hood, bumper system, frame, front body structure, tow hooks, hood pins, push bar and snowplows.

Your vehicle has a collection of crash and occupant sensors. These sensors provide information to the restraints control module which activates the following:

- Front seatbelt pretensioners.
- Driver airbag.
- Passenger airbag.
- Knee airbag(s).
- Seat mounted side airbags.
- Safety Canopy.

Based on the type of crash, the restraints control module deploys the appropriate safety devices.

The restraints control module also monitors the readiness of the above safety devices plus the crash and occupant sensors. The readiness of the safety system is indicated by a warning indicator light in the instrument cluster or by a backup tone if the warning light is not working. Routine maintenance of the airbag is not required.

A difficulty with the system is indicated by one or more of the following:



The readiness light will not illuminate immediately after you switch the ignition on.

- The readiness light either flashes or stays on.
- You hear a series of five tones. The tone pattern repeats periodically until the problem, the light or both are repaired.

If any of these things happen, even intermittently, have the supplemental restraint system serviced immediately. Unless serviced, the system may not function properly in the event of a crash.

The fact that the seatbelt pretensioners or front airbags did not activate for both front seat occupants in a crash does not mean that something is wrong with the system. Rather, it means the restraints control module determined the accident conditions (crash severity, seatbelt usage) were not appropriate to activate these safety devices.

- The front airbags activate only in frontal and near-frontal crashes. Front airbags may activate in rollovers, side impacts or rear impacts if the crash causes sufficient frontal deceleration.
- The seatbelt pretensioners activate in frontal, near-frontal and side crashes, and in rollovers.
- The knee airbag(s) deploy based on crash severity and occupant conditions.
- The side airbags inflate in certain side impact crashes or rollover events. Side airbags may activate in other types of crashes if the vehicle experiences sufficient sideways motion or deformation.
- The Safety Canopy inflates in certain side impact crashes or rollover events. The Safety Canopy may activate in other types of crashes if the vehicle experiences sufficient sideways motion or deformation, or a certain likelihood of rollover.

Airbags

CRASH SENSORS AND AIRBAG INDICATOR - POLICE RESPONDER



WARNING: Modifying or adding equipment to the front of your vehicle could affect the performance of the airbag system, increasing the risk of injury. This includes the hood, bumper system, frame, front body structure, tow hooks, hood pins, push bar and snowplows.

Your vehicle has a collection of crash and occupant sensors. These sensors provide information to the restraints control module which activates the following:

- Front seatbelt pretensioners.
- Driver airbag.
- Passenger airbag.
- Knee airbag(s).
- Seat mounted side airbags.
- Safety Canopy.

Based on the type of crash, the restraints control module deploys the appropriate safety devices.

The restraints control module also monitors the readiness of the above safety devices plus the crash and occupant sensors. The readiness of the safety system is indicated by a warning indicator light in the instrument cluster or by a backup tone if the warning light is not working. Routine maintenance of the airbag is not required.

A difficulty with the system is indicated by one or more of the following:

- The readiness light either flashes or stays on.
- You hear a series of five tones. The tone pattern repeats periodically until the problem, the light or both are repaired.



- The readiness light will not illuminate immediately after you switch the ignition on.

If any of these things happen, even intermittently, have the supplemental restraint system serviced immediately. Unless serviced, the system may not function properly in the event of a crash.

The fact that the seatbelt pretensioners or airbags did not activate for both front seat occupants in a crash does not mean that something is wrong with the system. Rather, it means the restraints control module determined the accident conditions (crash severity, belt usage) were not appropriate to activate these safety devices.

- The front airbags activate only in frontal and near-frontal crashes, not rollovers, side impacts or rear impacts, unless the crash causes sufficient frontal deceleration.
- The seatbelt pretensioners activate in frontal, near-frontal and side crashes and in rollovers.
- The side airbags inflate in certain side impact crashes and in rollovers. Side airbags may activate in other types of crashes if the vehicle experiences sufficient sideways motion or deformation.

Airbags

- The knee airbag(s) may deploy based on crash severity and occupant conditions.
- The Safety Canopy inflates in certain side impact crashes or rollover events. The Safety Canopy may activate in other types of crashes if the vehicle experiences sufficient sideways motion or deformation, or a certain likelihood of rollover.

Airbags and Police Equipment



WARNING: Do not place objects or mount equipment on or near the airbag cover, on the side of the front or rear seatbacks, or in areas that may come into contact with a deploying airbag. Failure to follow these instructions may increase the risk of personal injury in the event of a crash.



WARNING: Keep the areas in front of the airbags free from obstruction. Do not affix anything to or over the airbag covers. Objects could become projectiles during airbag deployment. Failure to follow this instruction could result in personal injury or death.

Dual driver and passenger airbags, side airbags and knee airbags affect the way police equipment can be mounted in police vehicles.

Any surfaces that could come into contact with an airbag, once it has deployed, must not damage the airbag or alter its deployment path.

Once the airbag has fully deployed, any peripheral equipment surfaces that could come into contact with the airbag, such as when the airbag deflates with the loading of an occupant, must not damage the airbag or alter its deployment path. Sharp edges, corners or protrusions could damage the nylon airbag material and reduce the effectiveness of the airbag.

Some approximate dimensions for airbags, at full inflation, are provided. These dimensions are somewhat flexible and represent free form deployments without the loading of occupants. The shaded areas in Figures 8 through 10 represent available police equipment mounting zones. These zones are shown for police vehicles with standard bucket seats. The zone dimensions provided in Figures 8 through 10 are approximate and will vary with the loading of occupants in the seats.

All airbag and equipment mounting zone dimensions are approximate due to different airbag deployment characteristics.

Do not mount equipment between the side of the front seat and the door trim that will block deployment of the side airbag.

Do not mount equipment between the seats and the body side as shown in Figure 7 that would prevent the side curtain airbag from achieving occupant coverage.

Airbags

Figure 1 - Driver and Passenger Airbag Dimensions

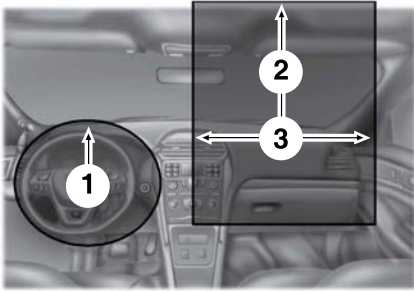

1. 9.5 in (240 mm) from the center of the emblem.
2. 13.3 in (339 mm) from the center of the airbag door.
3. 22.5 in (573 mm).

Note: Do not place objects between the airbags due to airbag variability.

Figure 2 - Side View of the Driver Airbag at Full Inflation

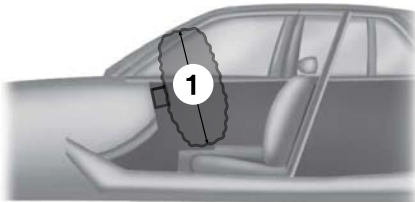

1. 27.5 in (700 mm).

Figure 3 - Top View of the Driver and Passenger Airbags at Full Inflation

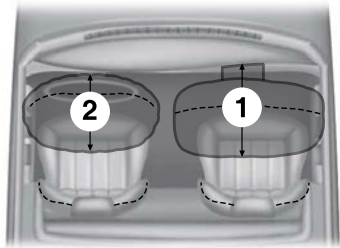

1. Front passenger airbag - 25.8 in (656 mm).
2. Front driver airbag - 17 in (430 mm).

Note: Do not place objects between the driver side steering wheel airbag and the passenger side dash airbag.

Figure 4 - Top View of the Side Airbags at Full Inflation - if equipped

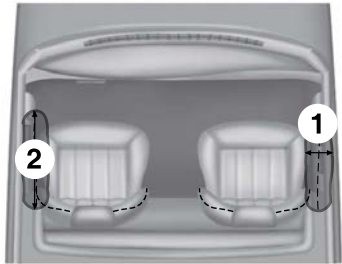

1. From the outermost side of the seat - 8 in (200 mm).
2. Forward of the seat backrest - 15 in (380 mm).

Airbags

Figure 5 - Side View of the Side Airbag at Full Inflation- if equipped

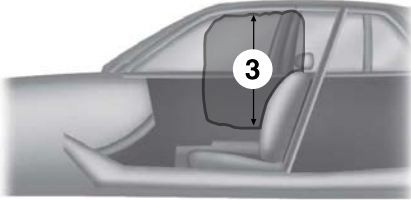

3. Up from the side airbag module - 27.5 in (700 mm).

Figure 6 - Side View of the Side Curtain Dimension

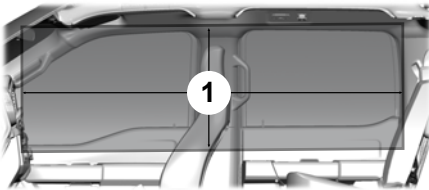

1. Roof rail to 1 in (25 mm) below the window sill.

Note: Do not place objects on the headliner or on pillar trims A through C used to conceal the airbag when stowed.

Figure 7 - Front View of the Side Curtain at Full Inflation

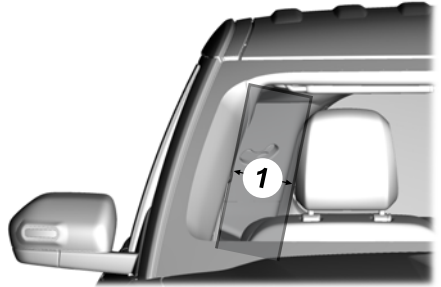

1. 6 in (75 mm) from pillar trim (A through C).

Figure 8 - Equipment Mounting Zones

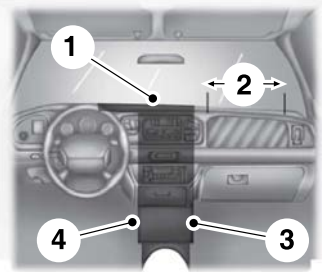

1. Area on top of the instrument panel. The equipment must not interfere with driver visibility.
2. Airbag door must be kept clear for deployment of the airbag.
3. Area in front of the center console from the bottom to the top of the instrument panel.
4. Area in front of the electronic finish panel from the bottom to the top of the instrument panel.

Airbags

Figure 9 - Equipment Mounting Zones

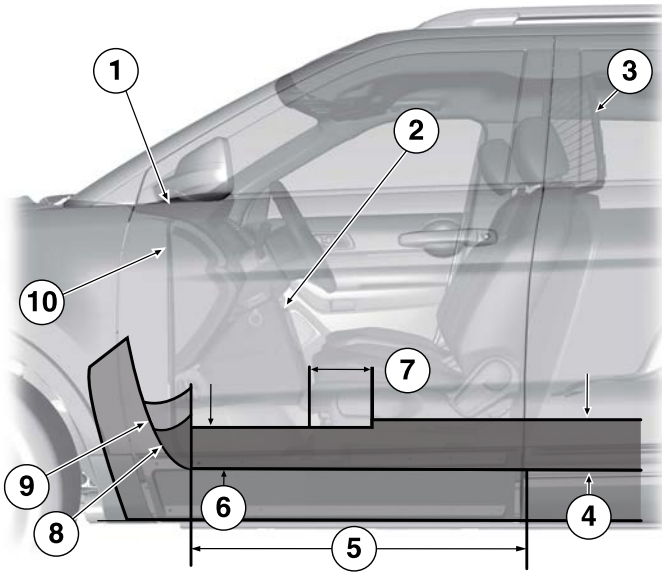

1. Area on top of the instrument panel.
2. Area in front of the center console from the tunnel up to the instrument panel.
3. Prisoner screen, for reference only.
4. 10 in (254 mm).
5. Area on tunnel between the seats.
6. Height: 8.5 in (216 mm).
7. 12 in (305 mm).
8. Area on the tunnel beneath the center console.
9. Tunnel.
10. Depth: 1.5 in (38 mm).

Airbags

Figure 10 - Top View of the Equipment Mounting Zones

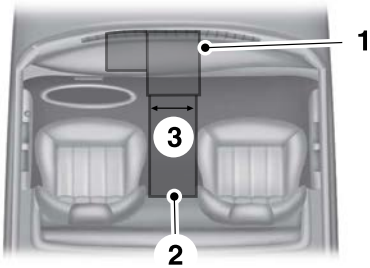

1. Area on top of the instrument panel. The equipment must not interfere with driver visibility.
2. Area on tunnel between the seats.
3. 9 in (229 mm).

DISPOSING OF AIRBAGS

Contact your authorized dealer as soon as possible. Airbags must be disposed of by qualified personnel.

Pedestrian Alert System (If Equipped)

WHAT IS THE PEDESTRIAN ALERT SYSTEM

Due to the quiet operation of hybrid and electric vehicles at low speeds, the system creates a subtle sound to alert pedestrians.

The system is on when your vehicle is running and not in park (P). Some sound may be audible in the passenger compartment.

911 Assist (If Equipped)

WHAT IS 911 ASSIST

911 Assist is a SYNC system feature that can call for help.

For more information, visit www.owner.ford.com.

HOW DOES 911 ASSIST WORK

If a crash deploys an airbag, excluding knee airbags and rear inflatable seatbelts, or activates the fuel pump shut-off, your vehicle may be able to contact emergency services by dialing 911 through a paired and connected **Bluetooth**®-enabled phone.

Not all crashes will deploy an airbag or activate the fuel pump shut-off. If a connected cell phone sustains damage or loses its connection to SYNC during a crash, SYNC will search for and try to connect to a previously paired cell phone. SYNC will then attempt to call the emergency services.

Before making the call:

- SYNC provides about 10 seconds to cancel the call. If you fail to cancel the call, SYNC attempts to dial 911.
- SYNC says the following, or a similar message: "SYNC will attempt to call 911, to cancel the call, press Cancel on your screen or press and hold the phone button on your steering wheel."

If you do not cancel the call and SYNC makes a successful call a pre-recorded message plays for the 911 operator. The occupants in your vehicle are able to talk with the operator. Be prepared to provide your name, phone number and location immediately because not all 911 systems are capable of receiving this information electronically.

During an emergency call the system transmits vehicle data to the emergency service.

EMERGENCY CALL REQUIREMENTS



WARNING: Do not wait for 911 Assist to make an emergency call if you can do it yourself. Dial emergency services immediately to avoid delayed response time which could increase the risk of serious injury or death after a crash. If you do not hear 911 Assist within five seconds of the crash, the system or phone may be damaged or non-functional.



WARNING: Always place your phone in a secure location in your vehicle so it does not become a projectile or get damaged in a crash. Failure to do so may cause serious injury to someone or damage the phone which could prevent 911 Assist from working properly.



WARNING: Unless the 911 Assist setting is set on before a crash, the system will not dial for help which could delay response time, potentially increasing the risk of serious injury or death after a crash.

- SYNC is powered and working properly at the time of the incident and throughout feature activation and use.
- The 911 Assist feature must be set on before the incident.
- You must pair and connect a **Bluetooth**® enabled and compatible cell phone to SYNC.
- A connected **Bluetooth**® enabled phone must have the ability to make and maintain an outgoing call at the time of the incident.

911 Assist (If Equipped)

- A connected **Bluetooth**® enabled phone must have adequate network coverage, battery power and signal strength.
- The vehicle must have battery power and be located in the U.S., Canada or in a territory in which 911 is the emergency number.

Note: *If any user sets 911 Assist to on or off, that setting applies for all paired phones. If 911 Assist is off and the phone connected to SYNC, an icon displays on the status bar.*

Note: *Every phone operates differently. While SYNC 911 Assist works with most cellular phones, some may have trouble using this feature.*

EMERGENCY CALL LIMITATIONS

The SYNC 911 Assist feature only operates in the U.S., Canada or in a territory in which 911 is the emergency number. The following are limitations of this feature:

- Your cellular phone or 911 Assist hardware sustains damage in a crash.
- The vehicle's battery or the SYNC system has no power.
- The phone(s) thrown from your vehicle are the ones paired and connected to the system.

Keys and Remote Controls

REMOTE CONTROL LIMITATIONS



WARNING: Changes or modifications not expressly approved by the party responsible for compliance could void the user's authority to operate the equipment. The term "IC:" before the radio certification number only signifies that Industry Canada technical specifications were met.

This device complies with Part 15 of the FCC Rules and with Industry Canada license-exempt RSS standard(s). Operation is subject to the following two conditions: (1) This device may not cause harmful interference, and (2) This device must accept any interference received, including interference that may cause undesired operation.

Make sure a valid remote control is within 5 ft (1.5 m) from the front door handles and rear of vehicle.

The system may not function if:

- The remote control remains stationary for about a minute.
- The vehicle battery has no charge.
- The remote control battery has no charge.
- There is interference causing issues with the remote control frequencies.
- The remote control is too close to metal objects or electronic devices, for example keys or a cell phone.

USING THE REMOTE CONTROL - POLICE RESPONDER



Note: If there is a problem with the remote entry system, make sure to take all remote controls with you to an authorized dealer in order to aid in troubleshooting the problem.

Unlock



Press the button to unlock all doors. See **Unlocking and Locking the Doors Using the Remote Control** (page 102).

Lock



Press the button to lock all doors. See **Unlocking and Locking the Doors Using the Remote Control** (page 102).

Sounding the Panic Alarm (If Equipped)



Press the button to sound the panic alarm. Press the button again or switch the ignition on to turn it off.

Keys and Remote Controls

Note: The panic alarm operates regardless of the ignition position.

USING THE REMOTE CONTROL

Use your remote control to access various vehicle systems.

Note: The buttons on your remote may vary depending on the vehicle region or options.

Unlock



Press the button to unlock all doors. See **Unlocking and Locking the Doors Using the Remote Control** (page 102).

Lock



Press the button to lock all doors. See **Unlocking and Locking the Doors Using the Remote Control** (page 102).

Remote Start (If Equipped)



Press the button to remote start. See **Remotely Starting and Stopping the Vehicle** (page

178).

Tailgate (If Equipped)



Press the button to open the tailgate. See **Opening the Tailgate Using the Remote Control** (page 125).

Panic Alarm (If Equipped)



Press the button to sound the panic alarm. See **Sounding the Panic Alarm** (page 89).

OPENING AND CLOSING THE FLIP KEY

Opening Your Flip Key

Press the round button on the remote control to extend the flip key.

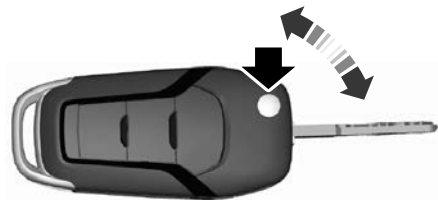

Note: Inspect the key blade for debris. Periodically clean with a brush.

Closing Your Flip Key

Press and hold the round button on the remote control to fold the key blade when not in use.

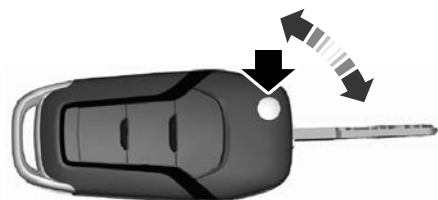

Keys and Remote Controls

REMOVING THE KEY BLADE



Push the release button on your passive key and pull the key blade out.

SOUNDING THE PANIC ALARM



Press the button to sound the panic alarm. Press the button again, or switch the ignition on to turn it off.

Note: *The panic alarm only operates when the ignition is off.*

LOCATING YOUR VEHICLE



Press the lock button twice within three seconds. The turn signal lamps flash.

Note: *We recommend you use this method to locate your vehicle.*

CHANGING THE REMOTE CONTROL BATTERY - POLICE RESPONDER



WARNING: Keep batteries away from children to prevent ingestion. Failure to follow this instruction could result in personal injury or death. If ingested, immediately seek medical attention.



WARNING: If the battery compartment does not securely close, stop using the remote control and replace it as soon as possible. In the meantime, keep the remote control away from children. Failure to follow this instruction could result in personal injury or death.

The remote control uses one coin-type three-volt lithium battery CR2032 or equivalent.



Make sure you dispose of old batteries in an environmentally friendly way. Seek advice from local authorities about recycling old batteries.

Keys and Remote Controls



1. Twist a thin coin in the slot of the remote control near the key ring to remove the battery cover.

Note: Do not remove the rubber cover and circuit board from the front housing of the remote control.

Note: Do not wipe off any grease on the battery terminals or on the back surface of the circuit board.

2. Remove the old battery.
3. Insert the new battery. Refer to the symbols inside the remote control for the correct orientation of the battery. Press the battery down to make sure you have it fully seated in the housing.
4. Reinstall the battery housing cover onto the remote control.

Note: Replacing the battery does not erase the programmed key from your vehicle. The remote control operates normally.

CHANGING THE REMOTE CONTROL BATTERY - VEHICLES WITH: PUSH BUTTON START

WARNING: Keep batteries away from children to prevent ingestion. Failure to follow this instruction could result in personal injury or death. If ingested, immediately seek medical attention.

WARNING: If the battery compartment does not securely close, stop using the remote control and replace it as soon as possible. In the meantime, keep the remote control away from children. Failure to follow this instruction could result in personal injury or death.

The remote control uses one coin-type 3-volt lithium battery CR2450 or equivalent.



Keys and Remote Controls

1. Push the release button and pull the key blade out.

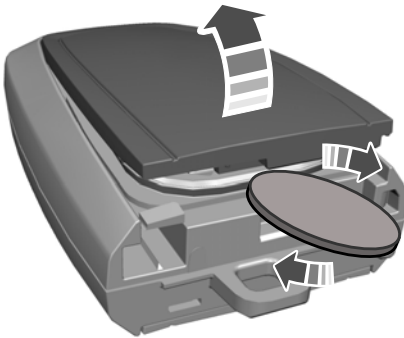
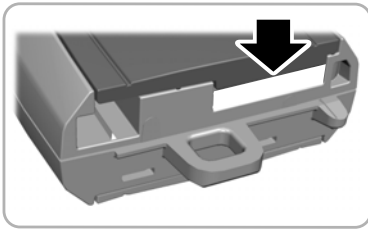

2. Twist a thin coin under the tab hidden behind the key blade head to remove the battery cover.

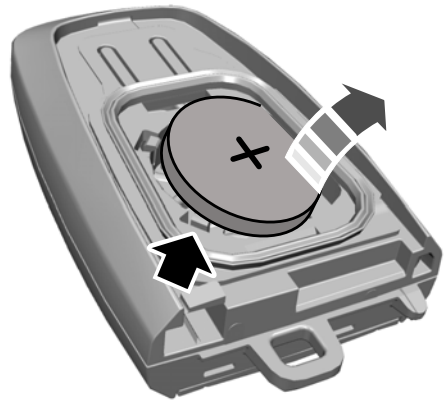

3. Insert a screwdriver, and carefully remove the battery.
4. Install a new battery with the + facing upward.
5. Reinstall the battery housing cover onto the transmitter and install the key blade.



Dispose of old batteries in an environmentally friendly way. Seek advice from your local authority about recycling old batteries.

Note: Do not wipe off any grease on the battery terminals or on the back surface of the circuit board.

Note: Replacing the battery does not erase the programmed key from your vehicle. The remote control should operate normally.

Keys and Remote Controls

CHANGING THE REMOTE CONTROL BATTERY - VEHICLES WITH: FLIP KEY

⚠ WARNING: Keep batteries away from children to prevent ingestion. Failure to follow this instruction could result in personal injury or death. If ingested, immediately seek medical attention.

⚠ WARNING: If the battery compartment does not securely close, stop using the remote control and replace it as soon as possible. In the meantime, keep the remote control away from children. Failure to follow this instruction could result in personal injury or death.

Battery Replacement Procedure

The remote control uses one coin-type 3-volt lithium battery CR2032 or equivalent.

Press the button to release the key blade before beginning the procedure.

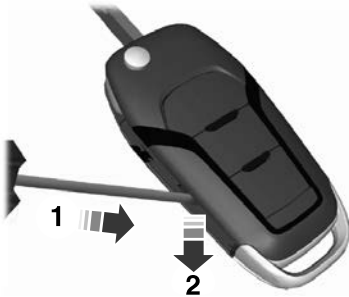

1. Insert a screwdriver, in the position shown and gently push the clip.
2. Press the clip down to release the battery cover.

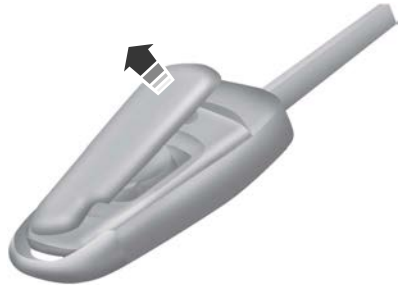

3. Carefully remove the cover.



4. Insert a screwdriver as shown to release the battery.



Note: Do not touch the battery contacts or the printed circuit board with the screwdriver.

5. Remove the battery.

Keys and Remote Controls

6. Install a new battery with the + facing up.
7. Replace the battery cover.



Dispose of old batteries in an environmentally friendly way. Seek advice from your local authority about recycling old batteries.

Note: Do not wipe off any grease on the battery terminals or on the back surface of the circuit board.

Note: Replacing the battery does not erase the programmed key from your vehicle. The remote control should operate normally.

REPLACING A LOST KEY OR REMOTE CONTROL

You can purchase replacement keys or remote controls from an authorized dealer. Authorized dealers can program remote controls for your vehicle.



Note: Your vehicle keys came with a security label that provides important key cut information. Keep the label in a safe place for future reference.

PROGRAMMING THE REMOTE CONTROL - VEHICLES WITH: PUSH BUTTON START

General Information

You must have two previously programmed remote controls inside your vehicle and the new unprogrammed remote controls readily accessible. Contact an authorized dealer to have the spare remote control programmed if two previously programmed remotes are not available. Make sure that your vehicle is off before beginning this procedure. Make sure that you close all the doors before beginning and that they remain closed throughout the procedure. Perform all steps within 30 seconds of starting the sequence. Stop and wait for at least one minute before starting again if you perform any steps out of sequence.

Read and understand the entire procedure before you begin.

Note: You can program a maximum of four remote controls to your vehicle.

Note: If your programmed remote controls are lost or stolen and you do not have an extra coded remote, you need to have your vehicle towed to an authorized dealer. Store an extra programmed remote away from your vehicle in a safe place to help prevent any inconvenience. Contact an authorized dealer to purchase additional spare or replacement remotes.

Steps for Programming Your Spare Remote Control

Note: Your vehicle is equipped with one of the following center consoles.

Keys and Remote Controls

Programming Backup Location

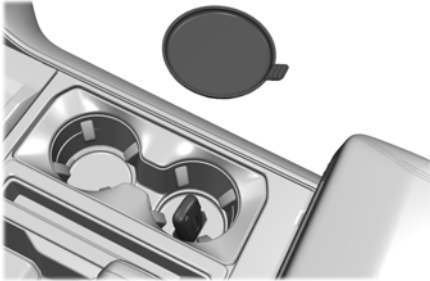

1. Place the first programmed remote in the backup slot inside the cup holder or center console with your foot off the brake pedal, press and release the push button ignition switch.
2. Wait five seconds and then press and release the push button ignition switch again.
3. Remove the remote control.
4. Within 10 seconds, place a second programmed remote control in the backup slot. Press and release the push button ignition switch.
5. Wait five seconds and then press and release the push button ignition switch again. Keep the ignition on for at least three seconds, but no more than 10 seconds.
6. Remove the remote control.

7. Place the unprogrammed remote control in the backup slot and press and release the push button ignition switch.

Programming is now complete. With your foot on the brake pedal, press the push button ignition switch to verify the remote control functions operate and your vehicle starts with the new remote control.

If programming was not successful, wait 10 seconds and repeat Steps 1 through 7. If you are still unsuccessful, take your vehicle to an authorized dealer.

PROGRAMMING THE REMOTE CONTROL - VEHICLES WITH: FLIP KEY

General Information

You can program your own remote control to your vehicle. This procedure programs both the engine immobilizer keycode and the remote entry portion of the remote control to your vehicle.

Only use remote controls with an integrated mechanical key.

You must have two previously programmed coded remote controls and the new un-programmed remote readily accessible. Contact an authorized dealer to have the spare remote control programmed if the two previously programmed coded remote controls are not available.

Read and understand the entire procedure before you begin.

Steps for Programming Your Spare Remote Control

1. Insert the first previously programmed coded key into the ignition.

Keys and Remote Controls

2. Switch the ignition from off to on. Keep the ignition on for at least three seconds, but no more than 10 seconds.
3. Switch the ignition off and remove the first coded key from the ignition.
4. After three seconds but within 10 seconds of switching the ignition off, insert the second previously coded key into the ignition.
5. Switch the ignition from off to on. Keep the ignition on for at least three seconds, but no more than 10 seconds.
6. Switch the ignition off and remove the second previously programmed coded key from the ignition.
7. After three seconds but within 10 seconds of switching the ignition off and removing the previously programmed coded key, insert the new un-programmed key into the ignition.
8. Switch the ignition from off to on. Keep the ignition on for at least six seconds until you hear the door locks cycle.
9. Remove the newly programmed coded key from the ignition.

The key starts the engine if programming is successful. You can operate the keyless remote entry system with the new remote control with integrated key.

If programming was not successful, wait 20 seconds and repeat Steps 1 through 8. If you are still unsuccessful, take your vehicle to an authorized dealer.

Note: *You can program a maximum of six coded remote controls to your vehicle.*

KEYS AND REMOTE CONTROLS – TROUBLESHOOTING

KEYS AND REMOTE CONTROLS – INFORMATION MESSAGES

| Message | Action |
|------------------------------|---------------------------------|
| Key Battery Low Replace Soon | Replace remote control battery. |

WHAT IS MYKEY

MyKey allows you to program keys with restricted driving modes to promote good driving habits.

MYKEY SETTINGS

NON-CONFIGURABLE MYKEY SETTINGS

Seatbelt Reminder or Belt-Minder™

MyKey mutes the audio system until the front seat passengers buckle the front seat belts.

Note: *If your vehicle includes an AM/FM radio or a very basic audio system, then the radio may not mute.*

Satellite Radio (If Equipped)

Some Satellite radio channels have restricted access to adult radio content.

Early Low Fuel

The low fuel level warning lamp turns on earlier.

Driving and Parking Aids

You cannot configure settings for parking aids, blind spot information system, and cross traffic alert. These systems turn on when the vehicle turns on, and you cannot switch them off with a MyKey.

You cannot configure settings for pre-collision assist and lane keeping. These systems turn on when the vehicle turns on, but you can switch them off with a MyKey.

A new destination in the navigation system can only be set using voice commands when using a MyKey, and with your vehicle moving.

Note: *MyKey drivers may be able to switch the lane departure warning feature off, but this feature turns back on automatically with every new key cycle.*

CONFIGURABLE MYKEY SETTINGS

You can configure the following settings after creating a MyKey. See **Creating a MyKey** (page 98).

Speed Limit



WARNING: Do not set MyKey maximum speed limit to a limit that will prevent the driver from maintaining a safe speed considering posted speed limits and prevailing road conditions. The driver is always responsible to drive in accordance with local laws and prevailing conditions. Failure to do so could result in accident or injury.

You can set a speed limit for your vehicle. Warning messages appear in the information display and a tone sounds if your vehicle reaches the set speed. You cannot override the set speed when using a MyKey.

Speed Minder

You can set a speed reminder for your vehicle. Warning messages appear in the information display and a tone sounds if your vehicle exceeds the set speed.

Audio System Volume Limit

The audio system maximum volume reduces. A message appears in the information display if you attempt to exceed the volume limit. Automatic volume control turns off.

MyKey™ (If Equipped)

Emergency Assistance

If you set emergency assistance to always on, you cannot switch it off with a MyKey.

Do Not Disturb

If you set do not disturb to always on, you cannot switch it off with a MyKey.

Note: *If a phone is connected using Apple CarPlay or Android Auto while driving with a MyKey, the driver can receive phone calls and text messages even if the do not disturb restriction is on, and if the vehicle comes with satellite radio, there is no restriction on the adult content.*

Traction and Stability Control

If you set traction control or stability control to always on, you cannot switch it off with a MyKey.

CREATING A MYKEY - VEHICLES WITH: PUSH BUTTON START

Vehicles with a center console shifter:

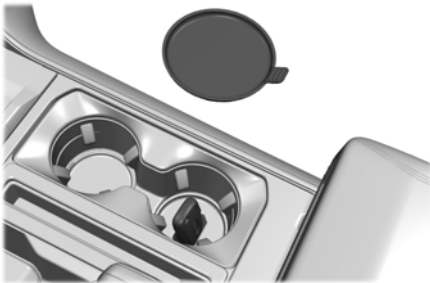

1. Remove the mat from the center console cup holder.
2. Remove the key blade from the transmitter.

3. Place the remote control in the backup slot with the buttons facing toward the front of the vehicle.
4. Switch the ignition on using an admin key.
5. Press **Settings** on the touchscreen.
6. Press **Vehicle Settings**.
7. Press **MyKey**.
8. Press **Create MyKey**.
9. Press **Yes**.

Note: *After you confirm the creation of a MyKey, we recommend that you label this key.*

Vehicles with a column shifter.

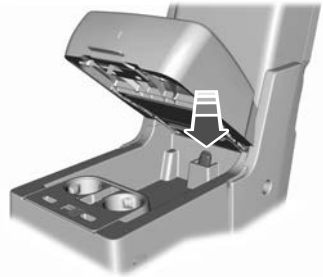

1. Raise the front center seat storage lid.
2. Place the remote control in the backup slot with the buttons facing toward the front of the vehicle.
3. Switch the ignition on using an admin key.
4. Press **Settings** on the touchscreen.
5. Press **Vehicle Settings**.
6. Press **MyKey**.
7. Press **Create MyKey**.
8. Press **Yes**.

Note: *After you confirm the creation of a MyKey, we recommend that you label this key.*

CREATING A MYKEY - VEHICLES WITH: FLIP KEY

1. Switch the ignition on using an admin key.
2. Press **Settings** on the touchscreen.
3. Press **Vehicle Settings**.
4. Press **MyKey**.
5. Press **Create MyKey**.
6. Press **Yes**.

Note: After you confirm the creation of a MyKey, we recommend that you label this key.

PROGRAMMING A MYKEY

You can program any remote control to become a restricted MyKey, but you must leave one unmodified as an admin key.

1. Switch the ignition on using an admin key.
2. Press **Settings** on the touchscreen.
3. Press **Vehicle Settings**.
4. Press **MyKey**.
5. Select a setting and press the **OK** button.
6. Configure the setting

CLEARING ALL MYKEYS

When you clear all MyKeys, you remove all restrictions and return all MyKeys to their original admin key status.

1. Switch the ignition on using an admin key.
2. Press **Settings** on the touchscreen.
3. Press **Vehicle Settings**.
4. Press **MyKey**.
5. Press **Clear All MyKeys**.
6. Press **Yes**.

CHECKING MYKEY SYSTEM STATUS

You can find information about the distance traveled using a MyKey, and the number of admin keys and MyKeys created for your vehicle.

1. Switch the ignition on.
2. Press **Settings** on the touchscreen.
3. Press **Vehicle Settings**.
4. Press **MyKey**.
5. Press **MyKey Information**.

USING MYKEY WITH REMOTE START SYSTEMS (IF EQUIPPED)

MyKey is not compatible with unapproved, aftermarket remote start systems. If you choose to install a remote start system, see an authorized dealer for an approved remote start system.

MYKEY – TROUBLESHOOTING

MYKEY – INFORMATION MESSAGES - VEHICLES WITH: PUSH BUTTON START

| Message | Description |
|---|---|
| Place Key in Backup Location | Displays when trying to create a MyKey and the admin key is not placed in the backup position. See Creating a MyKey (page 97). |
| Key is Already a MyKey | Displays when trying to create a MyKey with a key already designated as a MyKey. |
| This Key restricted at Next Key Cycle. Label Key as MyKey | Displays to confirm that the key is restricted after you switch the ignition off. |

MyKey™ (If Equipped)

MYKEY – INFORMATION MESSAGES - VEHICLES WITH: FLIP KEY

| Message | Description |
|---|---|
| Key is Already a MyKey | Displays when trying to create a MyKey with a key already designated as a MyKey. |
| This Key restricted at Next Key Cycle. Label Key as MyKey | Displays to confirm that the key is restricted after you switch the ignition off. |

MYKEY – FREQUENTLY ASKED QUESTIONS - VEHICLES WITH: PUSH BUTTON START

What is an admin key?

An admin key is a key that you have not created as a MyKey. See **Creating a MyKey** (page 97).

Why am I not able to create a MyKey?

You have not placed the admin key in the backup position. See **Creating a MyKey** (page 97). The key used to switch the ignition on is not an admin key. The key used to switch the ignition on is the only admin key. There has to be at least one admin key. You did not switch the ignition off after creating the last MyKey.

Why am I not able to program a MyKey?

The admin key is not inside your vehicle. The key used to switch the ignition on is not an admin key. You have not created any MyKeys. See **Creating a MyKey** (page 97).

Why am I not able to clear the MyKeys?

The admin key is not inside your vehicle. The key used to switch the ignition on is not an admin key. You have not created any MyKeys. See **Creating a MyKey** (page 97).

Why is the MyKey distance not accumulating?

The key used to start the engine is an admin key. An admin key and a MyKey are inside your vehicle. You have not created any MyKeys. See **Creating a MyKey** (page 97). You have cleared the MyKeys. See **Clearing All MyKeys** (page 98).

Why am I not able to start the engine with a MyKey?

An admin key and a MyKey are inside your vehicle. The system recognizes only the admin key when both are present.

MYKEY – FREQUENTLY ASKED QUESTIONS - VEHICLES WITH: FLIP KEY

What is an admin key?

An admin key is a key that you have not created as a MyKey. See **Creating a MyKey** (page 98).

Why am I not able to create a MyKey?

The key used to switch the ignition on is not an admin key. The key used to switch the ignition on is the only admin key. There has to be at least one admin key.

Why am I not able to program a MyKey?

The key used to switch the ignition on is not an admin key. You have not created any MyKeys. See **Creating a MyKey** (page 98).

Why am I not able to clear the MyKeys?

The key used to switch the ignition on is not an admin key. You have not created any MyKeys. See **Creating a MyKey** (page 98).

Why is the MyKey distance not accumulating?

The key used to start the engine is an admin key. You have not created any MyKeys. See **Creating a MyKey** (page 98). You have cleared the MyKeys. See **Clearing All MyKeys** (page 98).

Doors and Locks

OPERATING THE DOORS FROM OUTSIDE YOUR VEHICLE

UNLOCKING AND LOCKING THE DOORS USING THE REMOTE CONTROL (If Equipped)

You can only use the remote control when your vehicle is stationary.

Unlocking the Doors



Press the button to unlock all doors.

Locking the Doors



Press the button to lock all doors. One short flash of the turn signal lamps confirms that your vehicle has locked.

Note: For more information on operating the doors from outside your vehicle

UNLOCKING AND LOCKING THE DOORS USING THE KEY BLADE

If there is a power door lock fault you can use the key blade to lock and unlock the doors.

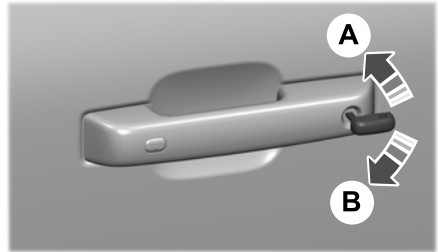

- A Lock.
- B Unlock.

OPERATING THE DOORS FROM INSIDE YOUR VEHICLE

INDIVIDUALLY UNLOCKING AND LOCKING THE DOORS USING THE LOCKING BUTTON

The power door lock control is on the driver and front passenger door panels.

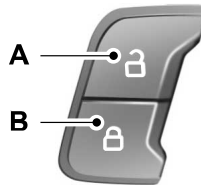

- A Unlock.
- B Lock.

Doors and Locks

OPENING THE DOORS FROM INSIDE YOUR VEHICLE - CREW CAB

Pull the interior door handle twice to unlock and open a rear door. The first pull unlocks the door and the second pull opens the door.

AUTOUNLOCK (IF EQUIPPED)

WHAT IS AUTOUNLOCK

Autounlock is an unlocking feature that unlocks the vehicle doors when your vehicle comes to a stop.

AUTOUNLOCK REQUIREMENTS

Autounlock unlocks all the doors when all of the following occur:

- The ignition is on, all the doors are closed and your vehicle is moving at a speed greater than 12 mph (20 km/h).
- Your vehicle comes to a stop.
- You open the driver door within 10 minutes of switching the ignition off or to the accessory position.

SWITCHING AUTOUNLOCK ON AND OFF

1. Press **Settings** on the touchscreen.
2. Press **Vehicle Settings**.
3. Switch **Autounlock** on or off.

AUTOLOCK (IF EQUIPPED)

WHAT IS AUTOLOCK

Autolock is a locking feature that locks your vehicle doors when you start driving.

AUTOLOCK REQUIREMENTS

Autolock locks all the doors when all of the following occur:

- All doors are closed.
- The ignition is on.
- Your vehicle reaches a speed greater than 12 mph (20 km/h).

MISLOCK (IF EQUIPPED)

WHAT IS MISLOCK

Mislock is a locking feature that warns you if your vehicle has not locked.

MISLOCK LIMITATIONS

When you press the lock button once, the turn signals do not flash if:

- Any door or the tailgate is open.
- The hood is open.

If you switch mislock off, the horn does not sound if you press the lock button on the remote control when a door is open.

SWITCHING MISLOCK ON AND OFF

1. Press **Settings** on the touchscreen.
2. Press **Vehicle Settings**.
3. Switch **Mislock Chirp** on or off.

DOORS AND LOCKS AUDIBLE WARNINGS

Door Ajar Audible Warning

Sounds when a door is not fully closed and your vehicle is moving.

Doors and Locks

DOORS AND LOCKS – TROUBLESHOOTING

DOORS AND LOCKS – WARNING LAMPS

Door Ajar Warning Lamp



It illuminates when you switch the ignition on and remains on if any door or the hood is open.

DOORS AND LOCKS – INFORMATION MESSAGES

| Message | Action |
|----------------------|---|
| Driver Door Ajar | Displays if a door is open. Fully close the door. |
| Passenger Door Ajar | |
| Rear Left Door Ajar | |
| Rear Right Door Ajar | |

Doors and Locks

DOORS AND LOCKS – FREQUENTLY ASKED QUESTIONS

Can accessories such as steps or handles be used with the latch assembly?

Do not use the door latch assembly to attach any accessory, such as handles or steps, as this can cause damage to your vehicle.

Keyless Entry (If Equipped)

KEYLESS ENTRY LIMITATIONS

Make sure your remote control is within 3 ft (1 m) from the front door handles and the tailgate.

The system could not function if:

- The remote control remains stationary for about a minute.
- The vehicle battery has no charge.
- The remote control battery has no charge.
- There is interference causing issues with the remote control frequencies.
- The remote control is too close to metal objects or electronic devices, for example keys or a cell phone.

KEYLESS ENTRY SETTINGS

Switching Keyless Entry On and Off

1. Switch the ignition on using an original key that has not been created as a MyKey.
2. Press **Settings** on the touchscreen.
3. Press **Vehicle Settings**.
4. Press **Locks**.

Reprogramming the Unlocking Function

You can enable two-stage unlocking function allowing you to unlock only the driver door when you touch the unlock sensor.

Press and hold both the lock and unlock buttons on the remote control for four seconds to disable or enable two-stage unlocking.

If you program the unlocking function so that only the driver door unlocks, you can unlock all of the other doors from inside your vehicle using the power door lock control. You can unlock individual doors by pulling the interior door handles on those doors.

USING KEYLESS ENTRY

Unlocking the Doors



With your passive key within 3 ft (1 m) of your vehicle, touch the unlock sensor on the back of the door handle for a brief period and then pull on the door handle to unlock, being careful not to touch the lock sensor at the same time or pull on the door handle too quickly. The intelligent access system requires a brief delay to authenticate your passive key.

Locking the Doors



With your passive key within 3 ft (1 m) of your vehicle, touch the outer door handle lock sensor for approximately one second to lock, being careful not to touch the unlock sensor on the back of the door handle at the same time. After locking, you can immediately pull on the door handle to confirm locking occurred without inadvertently unlocking.

Keyless Entry (If Equipped)

KEYLESS ENTRY – TROUBLESHOOTING

KEYLESS ENTRY – FREQUENTLY ASKED QUESTIONS

Why does the passive key not work?

The system deactivates passive keys left inside your vehicle when you lock it. You cannot switch the ignition on using a deactivated passive key. Press the unlock button on the remote control to reactivate a passive key.

Keyless Entry Keypad (If Equipped)

WHAT IS THE KEYLESS ENTRY KEYPAD

The keyless entry keypad allows you to lock and unlock your vehicle using the keypad on the window trim.

KEYLESS ENTRY KEYPAD LIMITATIONS

The system may not function if:

- The vehicle battery has no charge.

LOCATING THE KEYLESS ENTRY KEYPAD

The keypad is near the driver window and illuminates when you touch it.



KEYLESS ENTRY KEYPAD MASTER ACCESS CODE

What Is the Master Access Code

The master access code is a factory-set five-digit entry code. You can operate the keypad with the master access code at any time. The master access code is on the owner's wallet card in the glove box and is available from an authorized dealer.

KEYLESS ENTRY KEYPAD PERSONAL ACCESS CODES

Programming a Personal Entry Code

1. Enter the five-digit master code.
2. Press **1•2** on the keypad within five seconds.
3. Enter your personal five-digit code. You must do this within five seconds of completing Step 2.
4. Press **1•2** on the keypad to save personal code 1.

The doors lock then unlock to confirm that programming was successful.

To program additional personal entry codes, repeat Steps 1 through 3, then for Step 4:

- Press **3•4** to save personal code 2.
- Press **5•6** to save personal code 3.
- Press **7•8** to save personal code 4.
- Press **9•0** to save personal code 5.

If your vehicle comes with SYNC, you can also program the system with a personal entry code.

Hints:

- Do not set a code that uses five of the same number.
- Do not use five numbers in sequential order.
- The five-digit master code works even if you have set your own personal code.

Erasing a Personal Code

1. Enter the five-digit master code.
2. Press and release **1•2** on the keypad within five seconds.
3. Press and hold **1•2** for two seconds. You must do this within five seconds of completing Step 2.

Keyless Entry Keypad (If Equipped)

All personal codes erase and only the five-digit master code works.

Anti-Scan Feature

The keypad goes into an anti-scan mode if you enter the wrong code seven times. This mode turns off the keypad for one minute and the keypad lamp flashes.

The anti-scan feature turns off after:

- One minute of keypad inactivity.
- You press the unlock button on the remote control.
- You switch the ignition on.
- You unlock your vehicle using keyless entry.

USING THE KEYLESS ENTRY KEYPAD

Unlocking the Doors



Enter the factory-set five-digit code or your personal code. You must press each number within five seconds of each other.

- Press 3-4 within five seconds to unlock all doors.

Locking the Doors



Press and hold **7•8** and **9•0** at the same time with the driver door closed.

Note: You do not need to enter the code first.

KEYLESS ENTRY KEYPAD – TROUBLESHOOTING

KEYLESS ENTRY KEYPAD – FREQUENTLY ASKED QUESTIONS

Why does the keypad not accept the access code?

If you enter the access code too fast on the keypad, the unlock function may not work. Slowly re-enter the access code.

Why does the keypad not function?

The keypad goes into an anti-scan mode if you enter a wrong code seven times. The anti-scan mode disables the keypad for one minute and the red light flashes.

Easy Entry and Exit (If Equipped)

HOW DOES EASY ENTRY AND EXIT WORK

Easy entry and exit moves the driver seat rearward up to 2 in (5 cm) and may move the steering column up and in when you switch the ignition off. The driver seat and steering column return to their previous positions when you switch the ignition on.

SWITCHING EASY ENTRY AND EXIT ON AND OFF

1. Press **Settings** on the touchscreen.
2. Press **Vehicle**.
3. Select **Easy Entry/Exit**.

If you press any adjustment or memory button when in easy exit mode, the system cancels the operation.

Tailgate - Vehicles With: Manual Tailgate

TAILGATE PRECAUTIONS



WARNING: It is extremely dangerous to ride in a cargo area, inside or outside of a vehicle. In a crash, people riding in these areas are more likely to be seriously injured or killed. Do not allow people to ride in any area of your vehicle that is not equipped with seats and seatbelts. Make sure everyone in your vehicle is in a seat and properly using a seatbelt. Failure to follow this warning could result in serious personal injury or death.

OPENING THE TAILGATE

OPENING THE TAILGATE FROM OUTSIDE YOUR VEHICLE

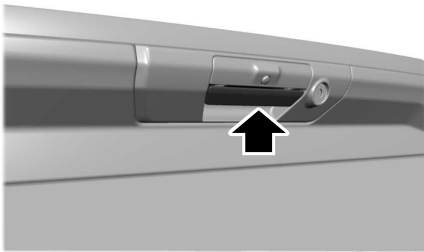

Pull up on the handle to release the tailgate.

Note: You may need to unlock the tailgate first.

LOCKING AND UNLOCKING THE TAILGATE

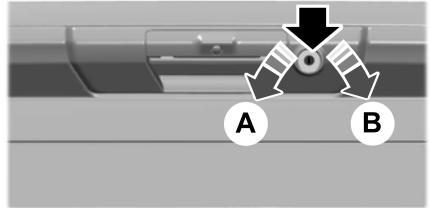

A Lock.

B Unlock.

1. Insert the ignition key into the tailgate lock.
2. Turn it to the left to lock the tailgate.
3. Turn it to the right to unlock the tailgate.

REMOVING AND INSTALLING THE TAILGATE



WARNING: Always properly secure cargo to prevent shifting cargo or cargo falling from the vehicle. Failure to do so could result in compromised vehicle stability and serious personal injury to vehicle occupants or others.

Note: Skip to Step 4 if your vehicle does not have power door locks.

Tailgate - Vehicles With: Manual Tailgate

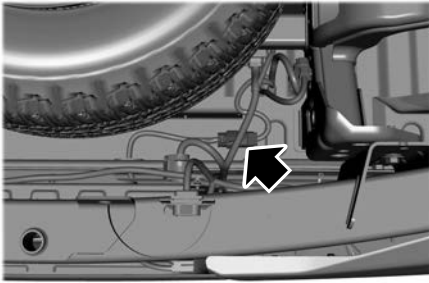

1. Unlatch the tailgate.
2. Disconnect the power door locks in-line connector. It is under the pickup box on the right-hand side of the vehicle near the spare tire.
3. Install a protective cap on the in-line connector portion that remains under the pickup box.

Note: A protective cap should be in the glove compartment.

4. Partially lower the tailgate. Carefully feed the tailgate harness up through the gap between the pickup box and the bumper and place it out of the way under the pickup box.
5. Lower the tailgate.

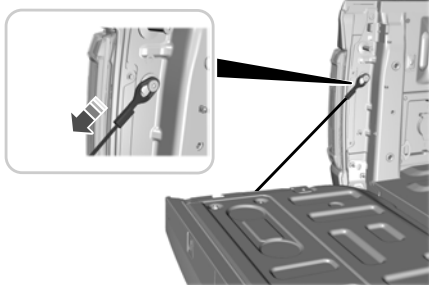

6. Use a screwdriver to gently pry the spring clip on each connector past the head of the support screw. Disconnect the cable.

7. Disconnect the other cable.

Note: To avoid damaging the tailgate, you may need assistance when removing. The tailgate weighs approximately 97 lb (44 kg).

8. Lift the tailgate to 45 degrees from the horizontal position.
9. Lift the right-hand side off its hinge.
10. Lift the tailgate to 80 degrees from the horizontal position.
11. Remove the tailgate from the left-hand side hinge by sliding it to the right.
12. Install the tailgate in reverse order.

TAILGATE STEP (IF EQUIPPED)

ACCESSING THE TAILGATE STEP

1. Lower the tailgate.
2. Push the button in the center of the step molding. The step pops out slightly.

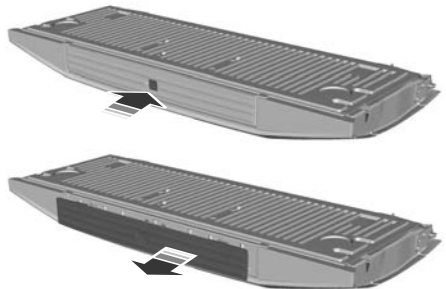

3. Pull the step out fully. Lower the step to its lowest position.

Tailgate - Vehicles With: Manual Tailgate

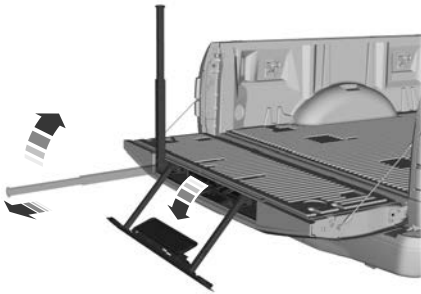

4. Pull the yellow handle stop backward out of the tailgate until it fully extends.
5. To lock the handle in place, rotate the handle up from the horizontal to the vertical position until you hear a click.

Note: Do not tow with the step or grab handle.

Replace the slip resistance tape or grab handle molding if it appears as worn or damaged.

To reduce the risk of falling:

- Only operate the step when your vehicle is on a level surface.
- Only operate the step in areas with sufficient lighting.
- Make sure you use the grab handle when climbing on the step.
- Do not use the step with bare feet.
- Make sure the step is clean before use.
- Keep the step load below the total maximum load of 350 lb (159 kg).

STOWING THE TAILGATE STEP

1. Press the yellow button on the handle to lower and then press the yellow lever at the bottom of the handle to unlock. Rotate the handle down from the vertical to the horizontal position and push it into the tailgate.

2. Rotate the step up until it is horizontal, then push it back into the tailgate until the step is secure.

Note: Make sure to close and fully latch the step before moving your vehicle. Do not drive with the step or grab handle open.

Note: The power tailgate cannot close if the step is opened. A warning message appears and a chime sounds. After stowing step the power close function is restored.

BED EXTENDER (IF EQUIPPED)

BED EXTENDER PRECAUTIONS

Note: Do not use the bed extender when driving off road.

Note: Make sure to engage the locking pins and knobs fully before driving your vehicle.

Note: Make sure to secure all cargo.

Note: Do not exceed 150 lb (68 kg) on the tailgate when your vehicle is moving.

Note: Do not keep the bed extender in the tailgate mode when you are not using it for restraining cargo. Always keep the bed extender in the grocery mode or the stowed position with the tailgate closed.

Tailgate - Vehicles With: Manual Tailgate

USING THE BED EXTENDER

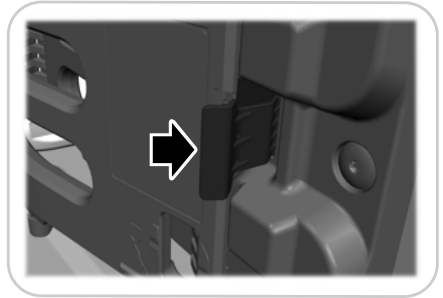
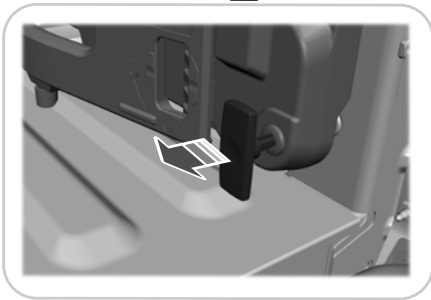
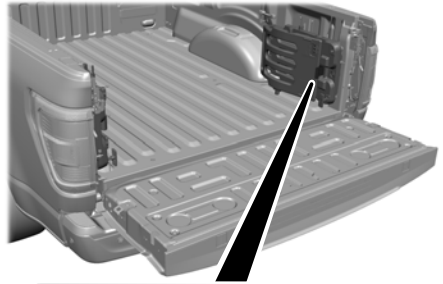
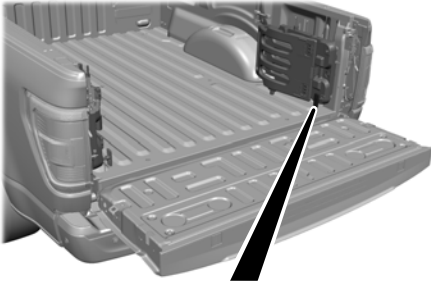

1. Pull the locking pin toward the center of your vehicle.

2. Open the latches to release the panels.

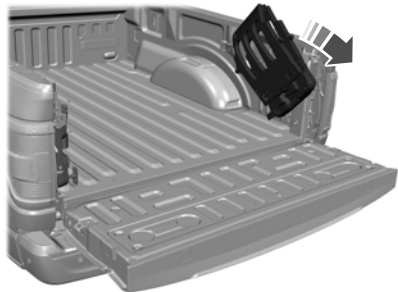

3. Rotate the panels toward the tailgate. Repeat steps 1-3 on the other side of your vehicle.

Tailgate - Vehicles With: Manual Tailgate

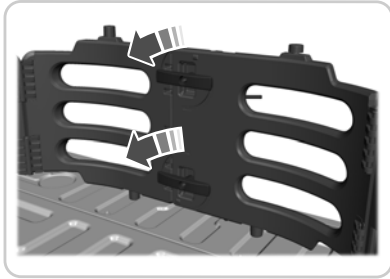

Grocery Mode

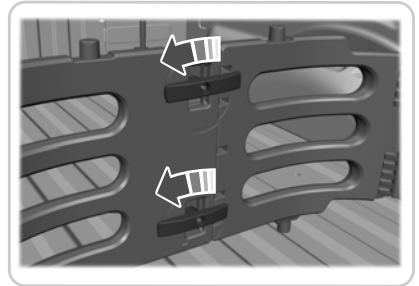
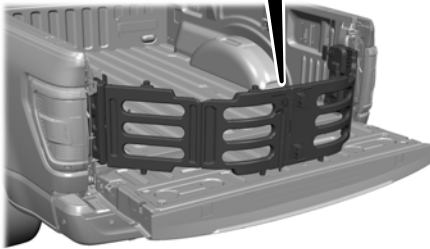
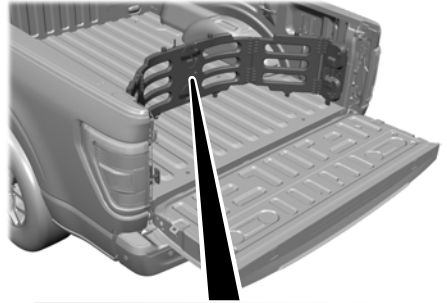

4. Connect the two panels. Rotate both knobs one-quarter turn clockwise to secure the panels.

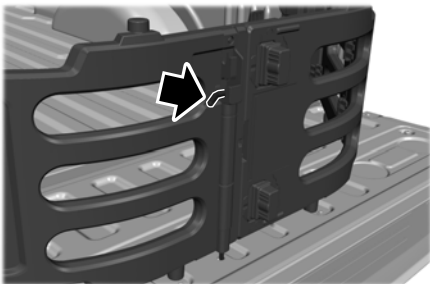

5. Insert the latch rod into the tailgate hole.
6. Engage both sides of the locking pins into their holes in the pick-up box.

1. Follow steps 1-4.
2. Before engaging the locking pins, rotate the panels away from the tailgate.
3. Engage both sides of the locking pins into their holes in the pick-up box.
4. Close the tailgate.

TAILGATE WORK SURFACE (IF EQUIPPED)

The tailgate work surface is a durable and functional surface on the inside portion of your tailgate you can use to perform various tasks.

To use the tailgate work surface, fold down the tailgate.

Tailgate - Vehicles With: Manual Tailgate

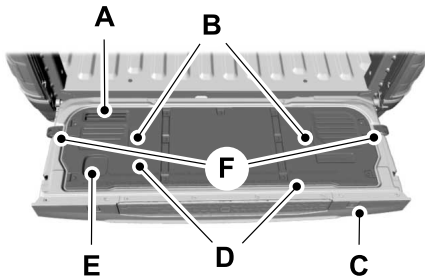

- A Tablet stand.
- B Tool inset.
- C Clamp pocket.
- D Standard and metric ruler.
- E Cup holder.
- F Tailgate anchors.

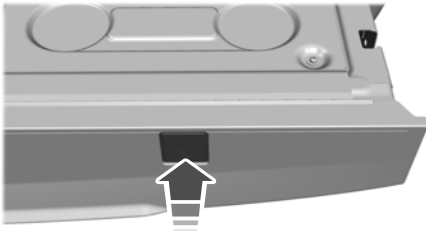

The tailgate work surface contains clamp pockets that allows you to secure work material.

Note: *Damage could occur to the tailgate if you overload the vertical clamp arm in any direction.*

Note: *When you finish using the tailgate work surface, make sure you remove all of your belongings, then close the tailgate.*

Tailgate - Vehicles With: Power Tailgate

TAILGATE PRECAUTIONS



WARNING: It is extremely dangerous to ride in a cargo area, inside or outside of a vehicle. In a crash, people riding in these areas are more likely to be seriously injured or killed. Do not allow people to ride in any area of your vehicle that is not equipped with seats and seatbelts. Make sure everyone in your vehicle is in a seat and properly using a seatbelt. Failure to follow this warning could result in serious personal injury or death.

OPENING THE TAILGATE

OPENING THE TAILGATE FROM INSIDE YOUR VEHICLE

The vehicle must be in park (P) to operate the power tailgate.



Press the button on the instrument panel.

Note: A tone sounds while the tailgate opens.

Note: The tailgate stops and reverses if it detects an obstruction when opening.

Note: An alert sounds if the electronic tailgate is disabled.

OPENING THE TAILGATE FROM OUTSIDE YOUR VEHICLE

1. Unlock the vehicle with the remote control or power door unlock control.

Note: If an intelligent access transmitter is within 3 ft (1 m) of the tailgate, the tailgate unlocks when you press the tailgate release button.

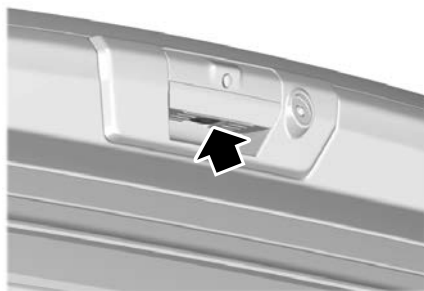

2. Press the button in the top of the tailgate handle.

OPENING THE TAILGATE USING THE REMOTE CONTROL



Press the remote control button twice within three seconds.

CLOSING THE TAILGATE

CLOSING THE TAILGATE FROM INSIDE YOUR VEHICLE



Press the button on the instrument panel.

Note: The tailgate stops and reverses if it detects an obstruction when closing.

CLOSING THE TAILGATE FROM OUTSIDE YOUR VEHICLE

You can close the power tailgate by:

- Pressing the tailgate button on your remote control twice within three seconds.
- Pressing the button on the instrument panel.
- Pressing the button on the tailgate.

Tailgate - Vehicles With: Power Tailgate

Note: The tailgate stops and reverses if it detects an obstruction when closing.

Lift-to-Close

To close the tailgate automatically using lift-to-close, lift the tailgate approximately 4 in (10 cm) and hold it for a few seconds.

Note: If the tailgate position is more than halfway between open and close, it may not close automatically.

Manual Close

You can close the tailgate manually when you lift the tailgate in a continuous motion.

If you stop the tailgate motion, the lift-to-close feature can engage and power close the tailgate.

Putting the Tailgate in Manual Mode

You can put the tailgate in manual mode through the vehicle settings in your touchscreen.

Note: In manual mode, the tailgate only functions by the tailgate release button and messaging is reduced.

CLOSING THE TAILGATE USING THE REMOTE CONTROL



Press the remote control button twice within three seconds.

REMOVING AND INSTALLING THE TAILGATE



WARNING: Always properly secure cargo to prevent shifting cargo or cargo falling from the vehicle. Failure to do so could result in compromised vehicle stability and serious personal injury to vehicle occupants or others.

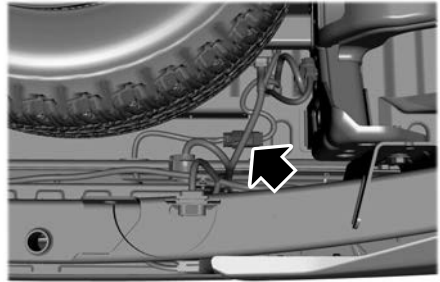

1. Put the tailgate into manual mode by accessing the vehicle settings using the touchscreen.
2. Open the tailgate.
3. Disconnect the power door locks in-line connector. It is under the pickup box on the right-hand side of the vehicle near the spare tire.
4. Install a protective cap on the in-line connector portion that remains under the pickup box.

Note: The protective cap is in the glove compartment.

5. Partially raise the tailgate. Carefully feed the tailgate harness up through the gap between the pickup box and the bumper and place it out of the way under the pickup box.
6. Fully lower the tailgate.

Tailgate - Vehicles With: Power Tailgate

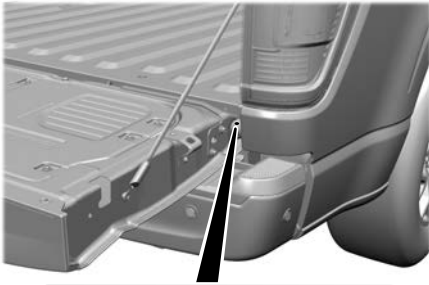

10. Lift the tailgate to 45 degrees from the horizontal position.
11. Lift the right-hand side off its hinge.
12. Lift the tailgate to 80 degrees from the horizontal position.
13. Remove the tailgate from the left-hand side hinge by sliding it to the right.
14. Install the tailgate in reverse order.

Note: After reinstalling the tailgate it is important to reinstall the retaining screw to the recommended torque, 7 lb.ft (10 Nm). Failure to install the retaining screw can cause the tailgate to detach.

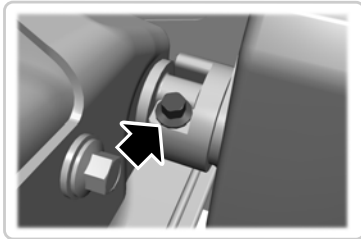

7. Remove the retaining screw.

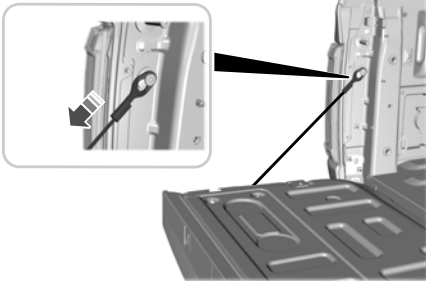

8. Use a screwdriver to gently pry the spring clip on each connector past the head of the support screw. Disconnect the cable.
9. Disconnect the other cable.

Note: To avoid damaging the tailgate, you may need assistance when removing. The tailgate weighs approximately 97 lb (44 kg).

TAILGATE STEP (IF EQUIPPED)

ACCESSING THE TAILGATE STEP

1. Lower the tailgate.
2. Push the button in the center of the step molding. The step pops out slightly.

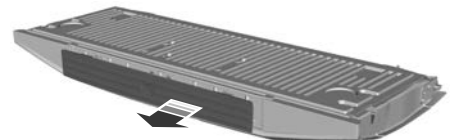

3. Pull the step out fully. Lower the step to its lowest position.

Tailgate - Vehicles With: Power Tailgate

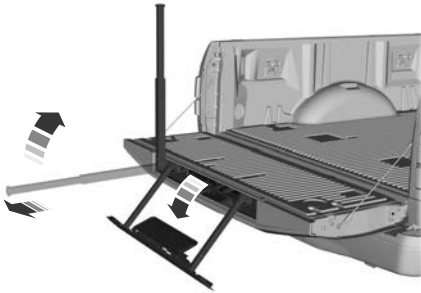

4. Pull the yellow handle stop backward out of the tailgate until it fully extends.
5. To lock the handle in place, rotate the handle up from the horizontal to the vertical position until you hear a click.

Note: Do not tow with the step or grab handle.

Replace the slip resistance tape or grab handle molding if it appears as worn or damaged.

To reduce the risk of falling:

- Only operate the step when your vehicle is on a level surface.
- Only operate the step in areas with sufficient lighting.
- Make sure you use the grab handle when climbing on the step.
- Do not use the step with bare feet.
- Make sure the step is clean before use.
- Keep the step load below the total maximum load of 350 lb (159 kg).

STOWING THE TAILGATE STEP

1. Press the yellow button on the handle to lower and then press the yellow lever at the bottom of the handle to unlock. Rotate the handle down from the vertical to the horizontal position and push it into the tailgate.

2. Rotate the step up until it is horizontal, then push it back into the tailgate until the step is secure.

Note: Make sure to close and fully latch the step before moving your vehicle. Do not drive with the step or grab handle open.

Note: The power tailgate cannot close if the step is opened. A warning message appears and a chime sounds. After stowing step the power close function is restored.

BED EXTENDER (IF EQUIPPED)

BED EXTENDER PRECAUTIONS

Note: Do not use the bed extender when driving off road.

Note: Make sure to engage the locking pins and knobs fully before driving your vehicle.

Note: Make sure to secure all cargo.

Note: Do not exceed 150 lb (68 kg) on the tailgate when your vehicle is moving.

Note: Do not keep the bed extender in the tailgate mode when you are not using it for restraining cargo. Always keep the bed extender in the grocery mode or the stowed position with the tailgate closed.

Tailgate - Vehicles With: Power Tailgate

USING THE BED EXTENDER

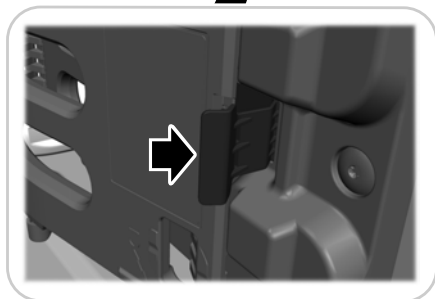
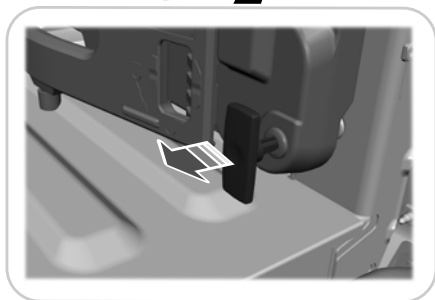
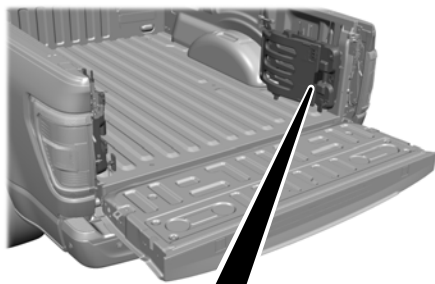
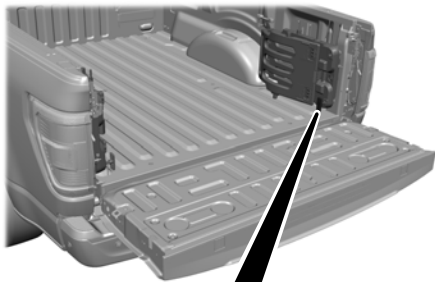

1. Pull the locking pin toward the center of your vehicle.

2. Open the latches to release the panels.

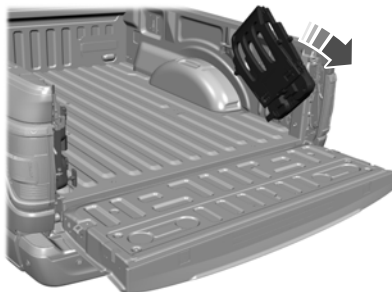

3. Rotate the panels toward the tailgate. Repeat steps 1-3 on the other side of your vehicle.

Tailgate - Vehicles With: Power Tailgate

Grocery Mode

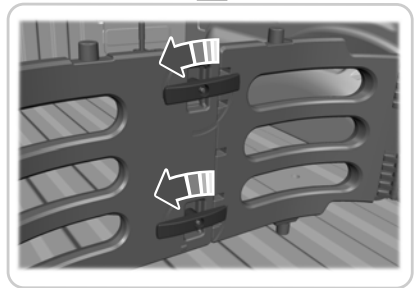
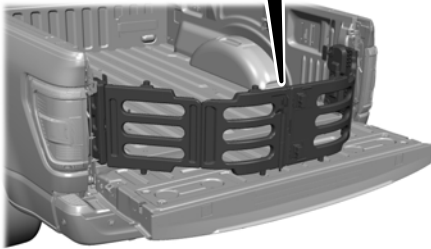
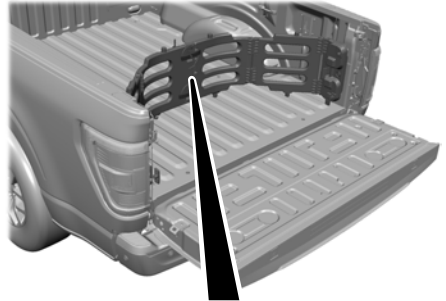
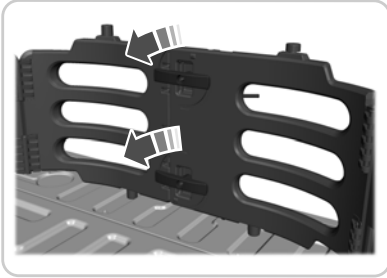

4. Connect the two panels. Rotate both knobs one-quarter turn clockwise to secure the panels.

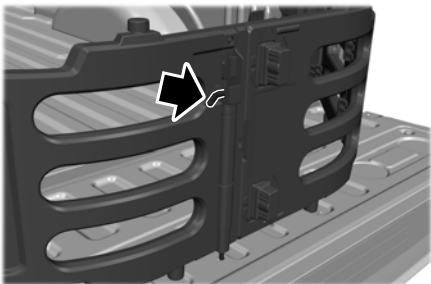

5. Insert the latch rod into the tailgate hole.
6. Engage both sides of the locking pins into their holes in the pick-up box.

1. Follow steps 1-4.
2. Before engaging the locking pins, rotate the panels away from the tailgate.
3. Engage both sides of the locking pins into their holes in the pick-up box.
4. Close the tailgate.

TAILGATE WORK SURFACE (IF EQUIPPED)

The tailgate work surface is a durable and functional surface on the inside portion of your tailgate you can use to perform various tasks.

To use the tailgate work surface, fold down the tailgate.

Tailgate - Vehicles With: Power Tailgate

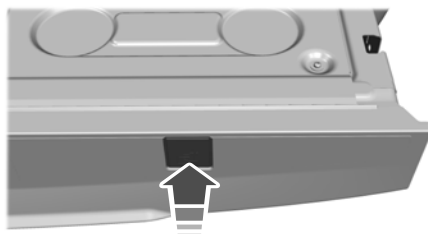
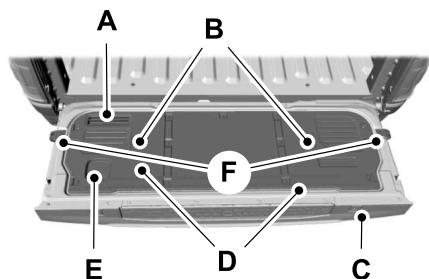

- A Tablet stand.
- B Tool inset.
- C Clamp pocket.
- D Standard and metric ruler.
- E Cup holder.
- F Tailgate anchors.

The tailgate work surface contains clamp pockets that allows you to secure work material.

Note: *Damage could occur to the tailgate if you overload the vertical clamp arm in any direction.*

Note: *When you finish using the tailgate work surface, make sure you remove all of your belongings, then close the tailgate.*

TAILGATE – TROUBLESHOOTING

TAILGATE – WARNING LAMPS



Illuminates when the tailgate is not completely closed.

TAILGATE – INFORMATION MESSAGES

| Message | Action |
|--------------------------|---|
| Tailgate Ajar | The tailgate is not completely closed. |
| Power Tailgate Stow Step | You need to stow the tailgate step before the power tailgate can close. |

Tailgate - Vehicles With: Power Tailgate

TAILGATE – FREQUENTLY ASKED QUESTIONS

Why won't my power tailgate open?

Make sure the tailgate is in power mode. Make sure the transmission is in park (P), ensure nothing is obstructing the tailgate path and or causing resistance (tonneau cover or other aftermarket accessory, freezing conditions or being parked downhill). If you have continued issues, the battery voltage may be low or other system issues. See an authorized dealer.

Why won't my power tailgate close?

Make sure the tailgate is in power mode. Your vehicle speed is at or above 2.5 mph (4 km/h), the tailgate encountered an obstacle or freezing conditions. After removing the obstacles, manually close the tailgate to resume normal operation. If you have continued issues, the battery voltage may be low or other system issues. See an authorized dealer.

Tailgate - Vehicles With: Remote Release Tailgate

TAILGATE PRECAUTIONS



WARNING: It is extremely dangerous to ride in a cargo area, inside or outside of a vehicle. In a crash, people riding in these areas are more likely to be seriously injured or killed. Do not allow people to ride in any area of your vehicle that is not equipped with seats and seatbelts. Make sure everyone in your vehicle is in a seat and properly using a seatbelt. Failure to follow this warning could result in serious personal injury or death.

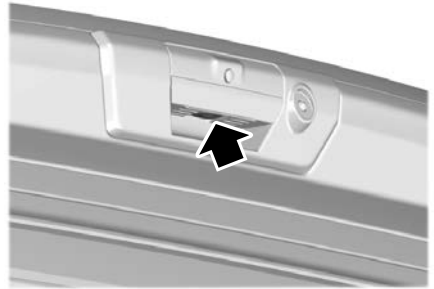

2. Press the button in the top of the tailgate handle.

OPENING THE TAILGATE

OPENING THE TAILGATE FROM INSIDE YOUR VEHICLE

The vehicle must be in park (P) to operate the power tailgate.



Press the button on the instrument panel.

Note: A tone sounds while the tailgate opens.

OPENING THE TAILGATE FROM OUTSIDE YOUR VEHICLE

1. Unlock the vehicle with the remote control or power door unlock control.

Note: If an intelligent access transmitter is within 3 ft (1 m) of the tailgate, the tailgate unlocks when you press the tailgate release button.

OPENING THE TAILGATE USING THE REMOTE CONTROL



Press the remote control button twice within three seconds.

REMOVING AND INSTALLING THE TAILGATE



WARNING: Always properly secure cargo to prevent shifting cargo or cargo falling from the vehicle. Failure to do so could result in compromised vehicle stability and serious personal injury to vehicle occupants or others.

Note: Skip to Step 4 if your vehicle does not have power door locks.

Tailgate - Vehicles With: Remote Release Tailgate

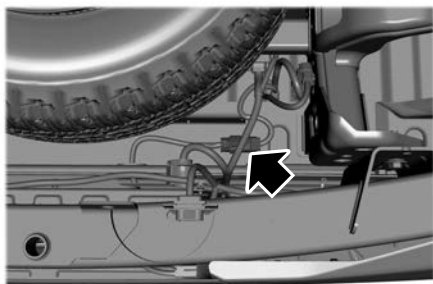

1. Unlatch the tailgate.
2. Disconnect the power door locks in-line connector. It is under the pickup box on the right-hand side of the vehicle near the spare tire.
3. Install a protective cap on the in-line connector portion that remains under the pickup box.

Note: A protective cap should be in the glove compartment.

4. Partially lower the tailgate. Carefully feed the tailgate harness up through the gap between the pickup box and the bumper and place it out of the way under the pickup box.
5. Lower the tailgate.

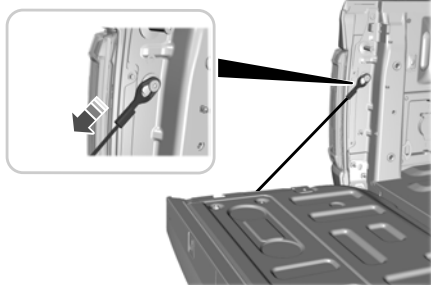

6. Use a screwdriver to gently pry the spring clip on each connector past the head of the support screw. Disconnect the cable.

7. Disconnect the other cable.

Note: To avoid damaging the tailgate, you may need assistance when removing. The tailgate weighs approximately 97 lb (44 kg).

8. Lift the tailgate to 45 degrees from the horizontal position.
9. Lift the right-hand side off its hinge.
10. Lift the tailgate to 80 degrees from the horizontal position.
11. Remove the tailgate from the left-hand side hinge by sliding it to the right.
12. Install the tailgate in reverse order.

TAILGATE STEP (IF EQUIPPED)

ACCESSING THE TAILGATE STEP

1. Lower the tailgate.
2. Push the button in the center of the step molding. The step pops out slightly.

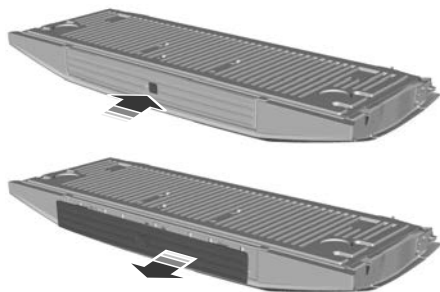

3. Pull the step out fully. Lower the step to its lowest position.

Tailgate - Vehicles With: Remote Release Tailgate

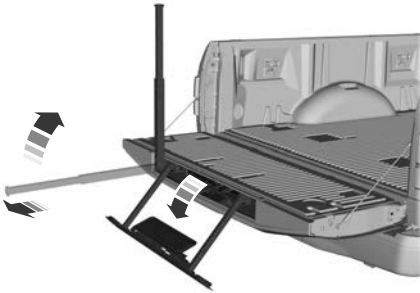

4. Pull the yellow handle stop backward out of the tailgate until it fully extends.
5. To lock the handle in place, rotate the handle up from the horizontal to the vertical position until you hear a click.

Note: Do not tow with the step or grab handle.

Replace the slip resistance tape or grab handle molding if it appears as worn or damaged.

To reduce the risk of falling:

- Only operate the step when your vehicle is on a level surface.
- Only operate the step in areas with sufficient lighting.
- Make sure you use the grab handle when climbing on the step.
- Do not use the step with bare feet.
- Make sure the step is clean before use.
- Keep the step load below the total maximum load of 350 lb (159 kg).

STOWING THE TAILGATE STEP

1. Press the yellow button on the handle to lower and then press the yellow lever at the bottom of the handle to unlock. Rotate the handle down from the vertical to the horizontal position and push it into the tailgate.

2. Rotate the step up until it is horizontal, then push it back into the tailgate until the step is secure.

Note: Make sure to close and fully latch the step before moving your vehicle. Do not drive with the step or grab handle open.

Note: The power tailgate cannot close if the step is opened. A warning message appears and a chime sounds. After stowing step the power close function is restored.

BED EXTENDER (IF EQUIPPED)

BED EXTENDER PRECAUTIONS

Note: Do not use the bed extender when driving off road.

Note: Make sure to engage the locking pins and knobs fully before driving your vehicle.

Note: Make sure to secure all cargo.

Note: Do not exceed 150 lb (68 kg) on the tailgate when your vehicle is moving.

Note: Do not keep the bed extender in the tailgate mode when you are not using it for restraining cargo. Always keep the bed extender in the grocery mode or the stowed position with the tailgate closed.

Tailgate - Vehicles With: Remote Release Tailgate

USING THE BED EXTENDER

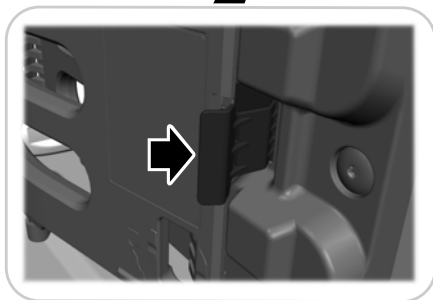
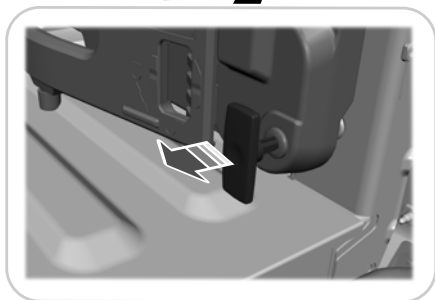
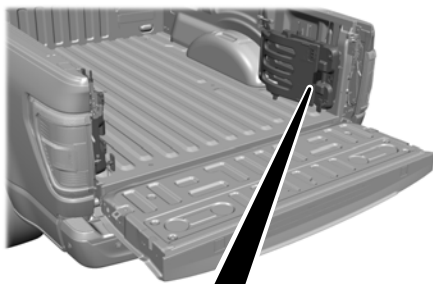
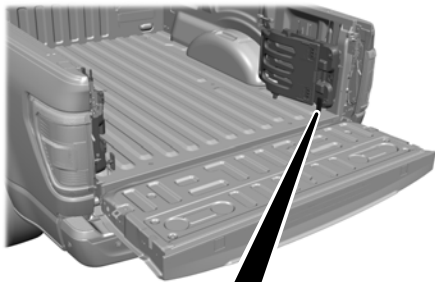

1. Pull the locking pin toward the center of your vehicle.

2. Open the latches to release the panels.

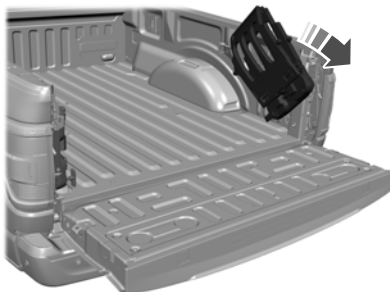

3. Rotate the panels toward the tailgate. Repeat steps 1-3 on the other side of your vehicle.

Tailgate - Vehicles With: Remote Release Tailgate

Grocery Mode

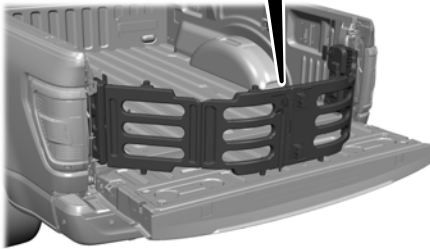
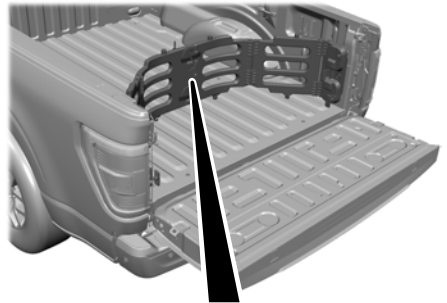
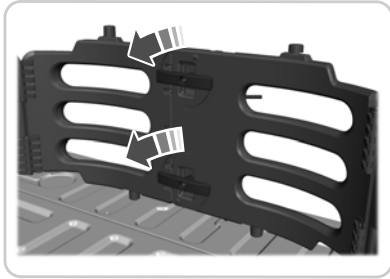

4. Connect the two panels. Rotate both knobs one-quarter turn clockwise to secure the panels.

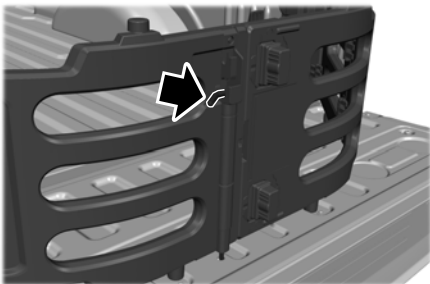
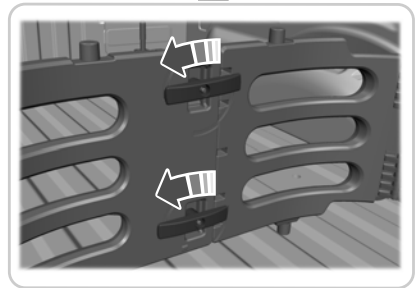

5. Insert the latch rod into the tailgate hole.
6. Engage both sides of the locking pins into their holes in the pick-up box.

1. Follow steps 1-4.
2. Before engaging the locking pins, rotate the panels away from the tailgate.
3. Engage both sides of the locking pins into their holes in the pick-up box.
4. Close the tailgate.

TAILGATE WORK SURFACE (IF EQUIPPED)

The tailgate work surface is a durable and functional surface on the inside portion of your tailgate you can use to perform various tasks.

To use the tailgate work surface, fold down the tailgate.

Tailgate - Vehicles With: Remote Release Tailgate

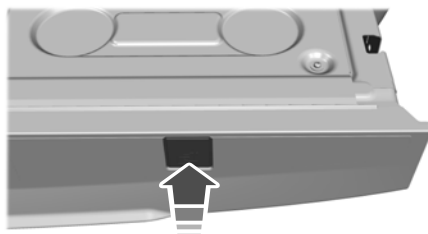
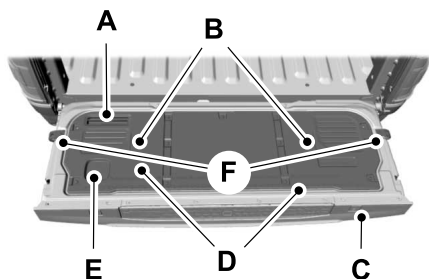

- A Tablet stand.
- B Tool inset.
- C Clamp pocket.
- D Standard and metric ruler.
- E Cup holder.
- F Tailgate anchors.

The tailgate work surface contains clamp pockets that allows you to secure work material.

Note: *Damage could occur to the tailgate if you overload the vertical clamp arm in any direction.*

Note: *When you finish using the tailgate work surface, make sure you remove all of your belongings, then close the tailgate.*

TAILGATE – TROUBLESHOOTING

TAILGATE – INFORMATION MESSAGES

| Message | Action |
|---|--|
| Check Tailgate Ajar | Reminder to check the tailgate due to it recently being opened from the remote control or the button on the instrument panel while the vehicle is on and the transmission is not in Park (P). You must clear the message using the steering wheel controls. Repeatedly closing the tailgate will not clear the message. |
| Power Tailgate System Fault Service Now | Reminder to check if tailgate is closed securely. If message persists contact an authorized dealer. |

Tailgate - Vehicles With: Remote Release Tailgate

TAILGATE – FREQUENTLY ASKED QUESTIONS

Why won't my tailgate open?

Make sure the transmission is in park (P), ensure nothing is obstructing the tailgate path and or causing resistance (tonneau cover or other aftermarket accessories, freezing conditions or being parked downhill). If you have continued issues, the battery voltage may be low or other system issues. See an authorized dealer.

Security

PASSIVE ANTI-THEFT SYSTEM

WHAT IS THE PASSIVE ANTI-THEFT SYSTEM

The passive anti-theft system prevents someone from starting the vehicle with an incorrectly coded key.

Note: *Do not leave a duplicate coded key in your vehicle. Always take the keys and lock all the doors when leaving your vehicle.*

HOW DOES THE PASSIVE ANTI-THEFT SYSTEM WORK

The passive anti-theft system arms when you switch the ignition off.

It disarms when the ignition is switched on with a correctly coded key.

Note: *The system is not compatible with non-Ford aftermarket remote start systems.*

Note: *Do not leave a duplicate coded key in your vehicle. Always take the keys and lock all doors when leaving your vehicle.*

ANTI-THEFT ALARM SYSTEM

(IF EQUIPPED)

WHAT IS THE ANTI-THEFT ALARM SYSTEM

The Anti-Theft Alarm System warns you of an unauthorized entry to your vehicle.

HOW DOES THE ANTI-THEFT ALARM SYSTEM WORK

When armed, the anti-theft alarm is triggered in any of the following ways:

- If someone opens a door, the tailgate or the hood without a correctly coded key or remote control.
- If you turn the power on without a correctly coded key.
- If the interior sensors detect movement inside your vehicle.
- If the inclination sensors detect an attempt to raise your vehicle.
- If someone disconnects the vehicle battery or the battery backup alarm.
- If someone disconnects the trailer. See **Connecting a Trailer** (page 399).

Any further attempts to carry out one of the above, sounds the alarm again.

If the anti-theft alarm is triggered, the alarm horn sounds for 30 seconds and the turn signals flash for five minutes.

WHAT IS THE PERIMETER ALARM

The perimeter alarm is designed to detect unauthorized access to your vehicle.

WHAT ARE THE INTERIOR SENSORS (If Equipped)

The interior sensors are designed to detect any movement inside your vehicle.

The interior sensors are in the overhead console.

Note: *Do not cover the interior sensors.*

Security

WHAT ARE THE INCLINATION SENSORS (If Equipped)

The inclination sensor is designed to detect an attempt to raise your vehicle, for example to remove a wheel or to tow it away.

ARMING THE ANTI-THEFT ALARM SYSTEM

The alarm is ready to arm when your vehicle is switched off.

Lock your vehicle with your remote control to arm the alarm.

DISARMING THE ANTI-THEFT ALARM SYSTEM

Disarm the alarm by performing any of the following actions:

- Unlock the doors or luggage compartment with the remote control.
- Switch your vehicle on or start your vehicle.

ANTI-THEFT ALARM SYSTEM SETTINGS (IF EQUIPPED)

WHAT ARE THE ALARM SECURITY LEVELS

You can select two levels of alarm security, motion sensors on and motion sensors off.

Motion Sensors On

Motion sensors on is the standard setting.

In motion sensors on, all equipped sensors are on when you arm the alarm.

Note: *Do not arm the alarm with motion sensors on if passengers, animals or other moving objects are inside your vehicle.*

Motion Sensors Off

In motion sensors off, the interior sensor and the inclination sensor are off when you arm the alarm.

All the other equipped sensors activate when you arm the alarm in this mode.

SETTING THE ALARM SECURITY LEVEL

1. Press **Settings** on the touchscreen.
2. Press **Vehicle Settings**.
3. Press **Alarm System**.
4. Press **Motion Sensors**.
5. Press a setting.

WHAT IS ASK ON EXIT

You can choose which level of security you require after you switch the ignition off.

Note: *If you do not choose a setting, the system defaults to all sensors.*

SWITCHING ASK ON EXIT ON AND OFF

1. Press **Settings** on the touchscreen.
2. Press **Vehicle Settings**.
3. Press **Alarm System**.
4. Switch **Ask on Exit** on or off.

Security

SECURITY – TROUBLESHOOTING

SECURITY – INFORMATION MESSAGES

| Message | Action |
|---|--|
| No Key Detected | The system has not detected a correctly coded key. |
| Starting System Fault | The system has malfunctioned. Have your vehicle checked as soon as possible. |
| Vehicle Alarm To Stop Alarm, Start Vehicle. | Displays when the alarm has been triggered due to unauthorized entry. |
| Alarm Announcement | |

Security

SECURITY – FREQUENTLY ASKED QUESTIONS

What should I do if there is any potential alarm problem with my vehicle?

Take all remote controls to an authorized dealer if there is any potential alarm problem with your vehicle.

What should I do if the vehicle is unable to start with a correctly coded key?

Have your vehicle checked as soon as possible.

Power Running Boards (If Equipped)

POWER RUNNING BOARD PRECAUTIONS



WARNING: In extreme climates, excessive ice buildup may occur, causing the running boards not to deploy. Make sure that the running boards have deployed, and have finished moving before attempting to step on them. The running boards will resume normal function once the blockage is cleared.



WARNING: Switch off the running boards before jacking or placing any object under your vehicle. Never place your hand between the extended running board and your vehicle. A moving running board may cause injury.

Do not use the running boards, front and rear hinge assemblies, running board motors, or the running board underbody mounts to lift your vehicle when jacking. Use proper jacking points.

The running boards could move slower in cold temperatures.

POWER RUNNING BOARD SETTINGS

1. Press **Features** on the touchscreen.
2. Press **Running Boards**.
3. Press a setting.

Running Boards (Modes)

Off

The power running boards remain stowed, regardless of door position.

Auto

The power running boards deploy when you approach your vehicle with a remote control, unlock the door or open the door.

The power running boards stow:

- After a few seconds when you close the doors.
- If you unlock the door but do not open it.
- If you have switched **Approach detection** on and do not open a door before the **Auto Timer** setting expires.

Note: When you select this mode, an option displays that allows you to select how long the running boards stay deployed without opening the door.

Out

The power running boards remain deployed, regardless of door position.

Approach detection

When you switch **Approach detection** on with **Auto** switched on, the running boards deploy when you approach your vehicle with a remote control.

POWER RUNNING BOARD KICK SWITCH

You can use the power running board kick switch to deploy and stow the running board without opening or closing the door.

Power Running Boards (If Equipped)

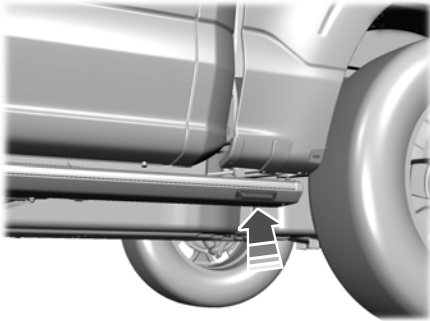

Press the switch with your foot to use the power running board kick switch.

Pressing the kick switch with the power running boards stowed switches the mode to **Out**.

Pressing the kick switch with the power running boards deployed switches the mode to **Auto**.

Note: When you use the kick switch, the power running board mode changes until you press the kick switch again.

You can change the kick switch setting on the touchscreen. See **Power Running Board Settings** (page 136).

Kick switch

Always active

The kick switch is on regardless of whether the doors are locked or unlocked.

Only while unlocked

The kick switch is on only with the doors unlocked.

DEPLOYING AND STOWING THE POWER RUNNING BOARDS

The power running boards deploy when you approach your vehicle with a remote control, unlock the door or open the door.

The power running boards stow:

- After a few seconds when you close the doors.
- If you unlock the door but do not open it.
- If you have switched **Approach detection** on and do not open a door before the **Auto Timer** setting expires. See **Power Running Board Settings** (page 136).

Note: The power running boards reverse direction and move to the end of travel if they encounter an object when moving.

POWER RUNNING BOARDS – TROUBLESHOOTING

POWER RUNNING BOARDS – FREQUENTLY ASKED QUESTIONS

Why is there unwanted noise coming from my power running boards?

The power running board mechanism could trap debris such as mud, dirt, snow, ice and salt. If this happens, set the running boards to the deployed position. Then, wash the system, in particular the front and rear hinge arms, with a high-pressure car wash wand.

Steering Wheel

ADJUSTING THE STEERING WHEEL - VEHICLES WITH: POWER ADJUSTABLE STEERING COLUMN



WARNING: Do not adjust the steering wheel when your vehicle is moving.

Note: Make sure that you are sitting in the correct position. See **Sitting in the Correct Position** (page 190).



Press the top or bottom of the control to move the steering wheel up or down.

Press the front or rear of the control to move the steering wheel in or out.

You can save and recall the steering wheel position with the memory function. See **Recalling a Preset Position** (page 204).

ADJUSTING THE STEERING WHEEL - VEHICLES WITH: MANUAL ADJUSTABLE STEERING COLUMN



WARNING: Do not adjust the steering wheel when your vehicle is moving.

Note: Make sure that you are sitting in the correct position. See **Sitting in the Correct Position** (page 190).

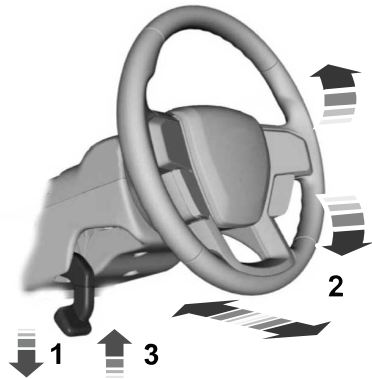

1. Unlock the steering column.
2. Adjust the steering wheel to the position you prefer.
3. Lock the steering column.

Steering Wheel

RESETTING THE STOPPING POSITION - VEHICLES WITH: POWER ADJUSTABLE STEERING COLUMN

Note: *The steering wheel stops when it detects an obstruction. This sets a new stopping position.*

To reset the steering column to its normal stopping position:

1. Confirm there is nothing obstructing the motion of the steering column.
2. Press and hold the steering column control until the steering column stops moving.
3. Press the steering column control again.

Note: *The steering column may start to move again.*

4. When the steering column stops, continue holding the control for a few seconds.
5. Repeat for each direction, as necessary.

On some vehicles, an indicator on the button illuminates when the heated steering wheel is on.

Note: *A sensor regulates the temperature of the steering wheel.*

HORN



Press on the center of the steering wheel near the horn icon to activate the horn.

SWITCHING THE HEATED STEERING WHEEL ON AND OFF - VEHICLES WITH: HEATED STEERING WHEEL



To activate the heated steering wheel, press the button on the climate control unit.

Adjustable Pedals (If Equipped)

ADJUSTING THE PEDALS



WARNING: Do not use the pedal adjustment controls when the vehicle is moving. Failure to follow this instruction could result in personal injury or death.

Your control is on the left-hand side of the steering column or on the instrument panel.

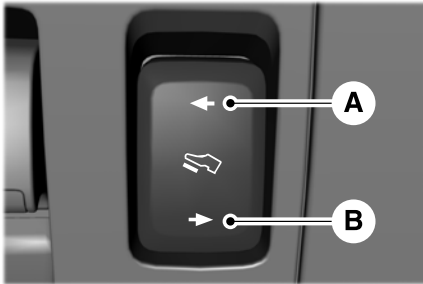

- A. Farther away from you.
- B. Closer to you.

You can save and recall the pedal positions with the memory feature. See **Memory Function** (page 204).

Wipers and Washers

WIPERS

WIPER PRECAUTIONS

Do not operate the wipers on a dry windshield. This could scratch the glass or damage the wiper blades. Use the windshield washers before wiping a dry windshield.

Fully defrost the windshield before you switch the windshield wipers on.

Switch the windshield wipers off before entering a car wash.

SWITCHING WINDSHIELD WIPERS ON AND OFF

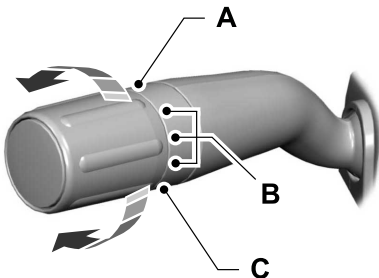

- A High-speed wipe.
- B Intermittent wipe.
- C Off.



Use the rotary control.

AUTOWIPERS (IF EQUIPPED)

WHAT ARE AUTOWIPERS

Autowipers turns on and controls the speed and frequency of the windshield wipers.

AUTOWIPERS SETTINGS

1. Press **Settings** on the touchscreen.
2. Press **Vehicle Settings**.
3. Press **Wipers**.
4. Switch **Rain Sensing** on or off.

Note: When you switch the feature off, the wipers do not operate based on the rain sensor. When you switch on the windshield wipers to the intermittent wipe position with the feature off, the wipers use the wipe speed set by the rotary control.

ADJUSTING THE SENSITIVITY OF THE RAIN SENSOR

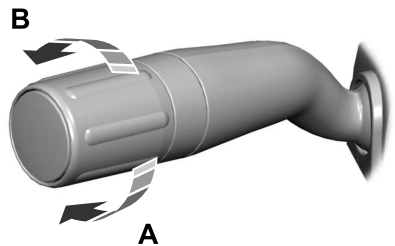

- A Low sensitivity.
- B High sensitivity.

Use the rotary control to set the sensitivity of the rain sensor.

Wipers and Washers

When you select low sensitivity, the wipers operate when the sensor detects a large amount of water on the windshield.

When you select high sensitivity, the wipers operate when the sensor detects a small amount of water on the windshield.

CHECKING THE WIPER BLADES



Run the tip of your fingers over the edge of the blade to check for roughness.

REPLACING THE FRONT WIPER BLADES

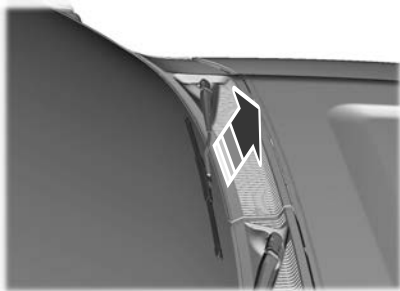

1. Pull the wiper blade and arm away from the glass.

Note: Do not hold the wiper blade to lift the wiper arm.

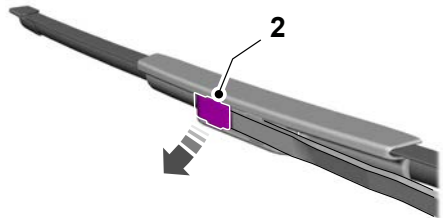

2. Lift the wiper blade primary locking clip.

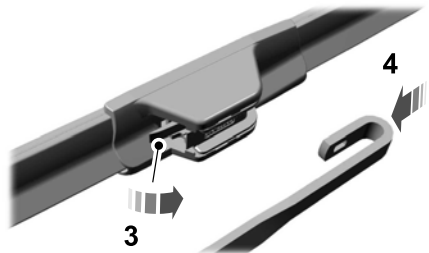

3. Press the wiper blade secondary locking clip.
4. Remove the wiper blade.

Note: Make sure that the wiper arm does not spring back against the glass when the wiper blade is not attached.

5. To install, reverse the removal procedure.

Note: Make sure that the wiper blade locks into place.

Wipers and Washers

WASHERS

WASHER PRECAUTIONS



WARNING: If you operate your vehicle in temperatures below 41°F (5°C), use washer fluid with antifreeze protection. Failure to use washer fluid with antifreeze protection in cold weather could result in impaired windshield vision and increase the risk of injury or accident.

Do not operate the washers when the washer reservoir is empty. This could cause the washer pump to overheat.

Keep the outside of the windshield clean. The rain sensor is very sensitive and the wipers may operate if dirt, mist or insects hit the windshield.

USING THE WINDSHIELD WASHER



Press and hold the button at the end of the lever to operate the windshield washer.

Note: A courtesy wipe occurs a short time after the wipers stop to clear any remaining washer fluid when switched on. See **Switching the Courtesy Wipe On and Off** (page 143).

SWITCHING THE COURTESY WIPE ON AND OFF

1. Press **Settings** on the touchscreen.
2. Press **Vehicle Settings**.
3. Press **Wipers**.
4. Switch **Courtesy Wipe** on or off.

ADDING WASHER FLUID

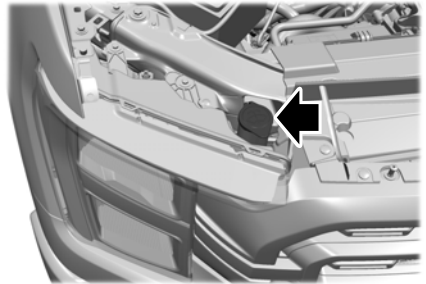

WASHER FLUID SPECIFICATION

See **Washer Fluid Specification** (page 589).

WIPERS AND WASHERS – TROUBLESHOOTING

WIPERS AND WASHERS – WARNING LAMPS



Illuminates when the windshield washer fluid is low.

Wipers and Washers

WIPERS AND WASHERS – FREQUENTLY ASKED QUESTIONS

Why are there streaks and smears on the windshield?

The wiper blades could be dirty, worn or damaged. Check the wiper blades. See **Checking the Wiper Blades** (page 142). If the wiper blades are dirty, clean them with washer fluid or water applied with a soft sponge or cloth. If the wiper blades are worn or damaged, install new ones. See **Replacing the Front Wiper Blades** (page 142).

Exterior Lighting

EXTERIOR LIGHTING CONTROL

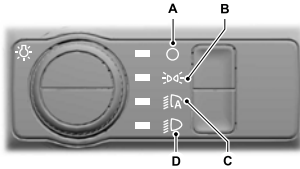

- A Lamps off.
- B Parking lamps on.
- C Autolamps on.
- D Headlamps on.

Rotate the control to make a selection.

Note: The lighting control defaults to autolamps every time you switch your vehicle on.

EXTERIOR LIGHTING CONTROL - POLICE RESPONDER

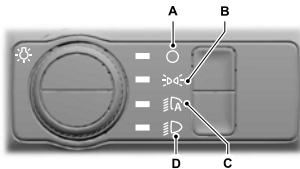

- A Lamps off.
- B Parking lamps on.
- C Autolamps on.
- D Headlamps on.

Rotate the control to make a selection.

Note: The lighting control defaults to the last known state every time you switch your vehicle on.

HEADLAMPS

USING THE HIGH BEAM HEADLAMPS

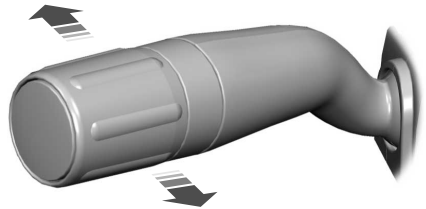

Push the lever away from you to switch the high beam on.

Push the lever forward again or pull the lever toward you to switch the high beams off.

Slightly pull the lever toward you and release it to flash the headlamps.

HEADLAMP INDICATORS

Lamps On



Illuminates when you switch the low beam headlamps or the parking lamps on.

Headlamp High Beam



Illuminates when you switch the high beam headlamps on.

Exterior Lighting

HEADLAMPS – TROUBLESHOOTING

HEADLAMPS – FREQUENTLY ASKED QUESTIONS

Why is there condensation in the headlamps?

Headlamps have vents to accommodate normal changes in air pressure. Condensation can be a natural by-product of this design. When moist air enters the lamp assembly through the vents, there is a possibility that condensation can occur when the temperature is cold. When normal condensation occurs, a fine mist can form on the interior of the lens. The fine mist eventually clears and exits through the vents during normal operation.

How much condensation is acceptable?

The presence of a fine mist, for example no streaks, drip marks or large droplets. A fine mist covers less than 50% of the lens.

How long may it take for the acceptable condensation to be cleared?

Clearing time may take as long as 48 hours under dry weather conditions.

How much condensation is unacceptable?

A water puddle inside the lamp. Streaks, drip marks or large droplets present on the interior of the lens.

What should I do if unacceptable condensation is present?

Have your vehicle checked as soon as possible.

Why do my headlamps turn off when I have them switched on when I switch my vehicle off?

The battery saver turns the headlamps off after a short period of time after you switch your vehicle off.

AUTOLAMPS

WHAT ARE AUTOLAMPS



WARNING: The system does not relieve you of your responsibility to drive with due care and attention. You may need to override the system if it does not turn the headlamps on in low visibility conditions, for example daytime fog.

Autolamps turn the headlamps on in low light situations or when the windshield wipers operate.

AUTOLAMP SETTINGS

1. Press **Settings** on the touchscreen.
2. Press **Vehicle Settings**.
3. Press **Lighting**.
4. Press **Autolamp Delay**.
5. Press a setting.

Exterior Lighting

EXTERIOR LAMPS

SWITCHING THE TURN SIGNAL LAMPS ON AND OFF

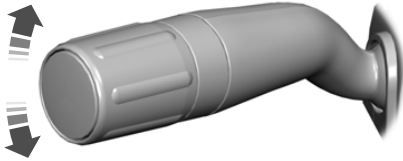

Push the lever up or down to switch the turn signal lamps on.

Set the lever to the middle position to switch the turn signal lamps off.

Note: Tap the lever up or down to make the turn signal lamps flash three times.

HOW DO CORNERING LAMPS WORK (If Equipped)

The cornering lamps illuminate the inside of a corner when you are turning the steering wheel or when you switch the turn signal lamps on. They turn on when the vehicle speed is below 25 mph (40 km/h).

Note: Only the cornering lamp on the side your vehicle is turning illuminates.

Note: Cornering lamps do not operate if you switch the front fog lamps on.

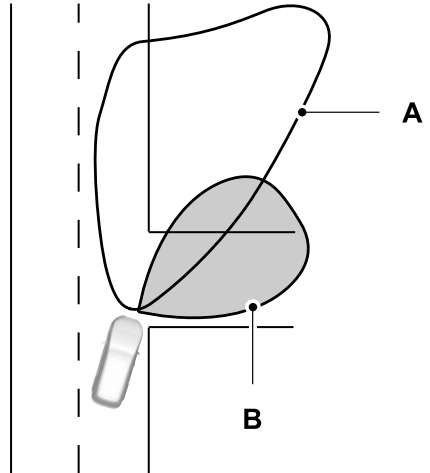

- A Headlamp beam.
B Cornering lamp beam.

SWITCHING THE DAYTIME RUNNING LAMPS ON AND OFF - VEHICLES WITH: CONFIGURABLE DAYTIME RUNNING LAMPS



WARNING: The daytime running lamps system does not activate the rear lamps and may not provide adequate lighting during low visibility driving conditions. Make sure you switch the headlamps on, as appropriate, during all low visibility conditions. Failure to do so may result in a crash.

1. Press **Settings** on the touchscreen.
2. Press **Vehicle Settings**.
3. Press **Lighting**.

Exterior Lighting

4. Switch **Daytime Running Lights** on or off.

The daytime running lamps turn on when all of the following occur:

- You switch the system on.
- You switch your vehicle on.
- The transmission is not in park (P) for vehicles with automatic transmissions or you release the parking brake for vehicles with manual transmissions.
- The lighting control is in the autolamps position.
- The headlamps are off.

Note: Other lighting control positions do not turn on the daytime running lamps.

SWITCHING THE DAYTIME RUNNING LAMPS ON AND OFF - VEHICLES WITH: DAYTIME RUNNING LAMPS (DRL)



WARNING: The daytime running lamps system does not activate the rear lamps and may not provide adequate lighting during low visibility driving conditions. Make sure you switch the headlamps on, as appropriate, during all low visibility conditions. Failure to do so may result in a crash.

Daytime running lamps are always on unless you switch on the headlamps or your vehicle is in park (P).

SWITCHING THE FRONT FOG LAMPS ON AND OFF (If Equipped)

The front fog lamp button is on the lighting control.



Press the button to switch the front fog lamps on or off.

Note: Only switch the front fog lamps on during reduced visibility.

Note: The brightness of the daytime running lamps may decrease when the front fog lamps are switched on.

Note: When the lighting control is in the autolamps position, you cannot switch the fog lamps on unless the headlamps are on.

SWITCHING THE FRONT FOG LAMPS ON AND OFF - RAPTOR (If Equipped)

The front fog lamp button is on the lighting control.



Press the button to switch the front fog lamps on or off.

Note: Only switch the front fog lamps on during reduced visibility.

Note: The brightness of the daytime running lamps may decrease when you switch the front fog lamps on.

Note: When the lighting control is in the autolamps position, you cannot switch the fog lamps on unless the headlamps are on.

Switching the Off-Road Lamps On and Off (If Equipped)

Use auxiliary switch 1 to switch the off-road lamps on and off. See **What Are the Auxiliary Switches** (page 636).

SWITCHING THE CARGO LAMPS ON



Press the button in the lighting control or in the rear cargo box.

Exterior Lighting

SWITCHING THE SPOT LAMP ON AND OFF (If Equipped)

The spot lamp buttons are near the lighting control.



Press the button to switch on the left-hand spot lamp.



Press the button to switch on the right-hand spot lamp.

Move the position of the exterior mirrors to adjust the aim.

Note: The lighting control must be set to the parking lamp position.

Note: The spot lamps illuminate the area in front of and to the side of your vehicle.

EXTERIOR LAMP INDICATORS

Front Fog Lamp



It illuminates when you switch the front fog lamps on.

Turn Signal Lamp



It flashes when you switch the turn signal lamps on.

Note: An increase in the rate of flashing warns of a failed turn signal lamp.

EXTERIOR LAMP AUDIBLE WARNING

Exterior Lamps On

Sounds when you open the driver door and the exterior lamps are on.

EXTERIOR ZONE LIGHTING (IF EQUIPPED)

WHAT IS EXTERIOR ZONE LIGHTING

Exterior zone lighting divides the exterior lighting into zones and allows you to switch them on and off to provide lighting around the perimeter of your vehicle.

USING THE EXTERIOR ZONE LIGHTING

1. Press **Features** on the touchscreen.
2. Press **Zone Lighting**.

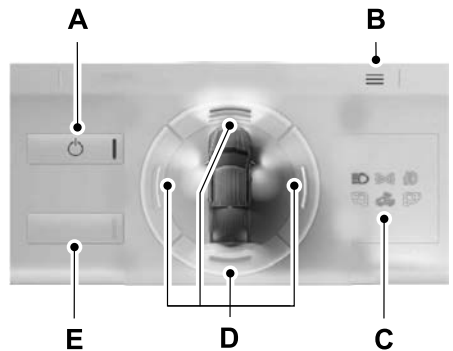

- A On and off button.
- B Settings menu.
- C Exterior lamp indicators.
- D Individual zones on and off.
- E All zones on and off.

You can use zone lighting when your vehicle is on or off. When it is off, the lighting turns off after a certain period of time.

Exterior Lighting

You can also use individual zone controls to switch on each zone.

Note: *Make sure to remove exterior lighting covers when using zone lighting.*

Note: *When your vehicle is off and the timer has one minute remaining, the direction indicators flash six times.*

Note: *Indicators on the touchscreen illuminate when the lights outside of the zone lighting control are on.*

Note: *You can remotely control the zone lighting using the FordPass app.*

Note: *Vehicles without spot lamps only have two zones.*

EXTERIOR ZONE LIGHTING SETTINGS

1. Press **Features** on the touchscreen.
2. Press **Zone Lighting**.
3. Press the settings menu in the upper right-hand corner.
4. Press a setting.

Enable Autolamp Override

This setting allows your vehicle to override the autolamps when using zone lighting.

When you access zone lighting for the first time, you can choose this setting. You can change this setting at any time.

Include Reverse Lamps

This setting turns the reverse lamps on when you switch the rear lighting zone on.

Switch this setting off if you have a backup alarm installed to prevent the reverse lamps from turning on and sounding the alarm when using zone lighting.

AUTOMATIC HIGH BEAM CONTROL

HOW DOES AUTOMATIC HIGH BEAM CONTROL WORK

Automatic high beam control turns the high beams on if it is dark enough and no other traffic is present. If it detects an approaching vehicle's headlamps or tail lamps, or street lighting ahead, the system turns the high beams off.

A camera sensor, centrally mounted behind the windshield of your vehicle, continuously monitors conditions to turn the high beams on and off.

Exterior Lighting

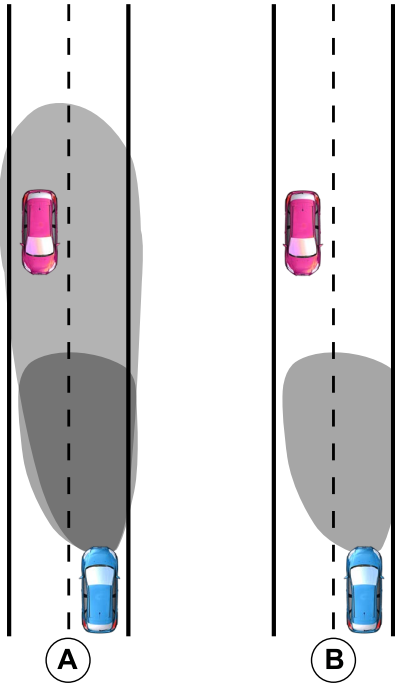

- A Without automatic high beam control.
- B With automatic high beam control.

AUTOMATIC HIGH BEAM CONTROL PRECAUTIONS

WARNING: The system does not relieve you of your responsibility to drive with due care and attention. You may need to override the system if it does not turn the high beams on or off.

WARNING: The system may not switch the high beams off if the lights of oncoming vehicles are hidden by obstacles, for example guard rails.

WARNING: Do not use the system in poor visibility, for example fog, heavy rain, spray or snow.

WARNING: You may need to override the system when approaching other road users.

WARNING: You may need to override the system during inclement weather.

AUTOMATIC HIGH BEAM CONTROL REQUIREMENTS

The system turns the high beams on if all of the following occur:

- You switch the system on.
- You set the lighting control to the autolamps position.
- The ambient light level is low enough that you require high beams.
- There is no traffic in front of your vehicle.
- The vehicle speed is greater than approximately 32 mph (52 km/h).

AUTOMATIC HIGH BEAM CONTROL LIMITATIONS

The system turns the high beams off if any of the following occur:

- You switch the system off.
- You set the lighting control to any position except autolamps.
- The ambient light level is high enough that you do not require high beams.

Exterior Lighting

- The system detects an approaching vehicle's headlamps or a leading vehicle's tail lamps.
- The system detects severe rain, snow or fog.
- The system detects street lighting.
- The camera has reduced visibility.
- The vehicle speed falls below approximately 19 mph (30 km/h).

OVERRIDING AUTOMATIC HIGH BEAM CONTROL

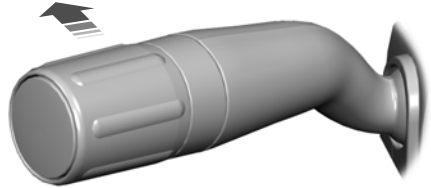

SWITCHING AUTOMATIC HIGH BEAM CONTROL ON AND OFF

1. Press **Settings** on the touchscreen.
2. Press **Vehicle Settings**.
3. Press **Lighting**.
4. Switch **Auto Highbeam** on or off.

AUTOMATIC HIGH BEAM CONTROL INDICATORS



Illuminates to confirm when the system is ready to assist.

Push the lever away from you to switch the high beams on.

Push the lever away from you again to switch the high beams off.

Push the lever away from you for a third time to switch automatic high beam control back on.

AUTOMATIC HIGH BEAM CONTROL – TROUBLESHOOTING

AUTOMATIC HIGH BEAM CONTROL – INFORMATION MESSAGES

| Message | Description |
|---|---|
| Front Camera Low Visibility Clean Screen | The camera has reduced visibility. Clean the windshield. If the message continues to appear, have your vehicle checked as soon as possible. |
| Front Camera Temporarily Not Available | The camera has malfunctioned. Wait a short period of time for the camera to cool down. If the message continues to appear, have your vehicle checked as soon as possible. |
| Front Camera Malfunction Service Required | The camera has malfunctioned. Have your vehicle checked as soon as possible. |

Exterior Lighting

GLARE FREE LIGHTING (IF EQUIPPED)

HOW DOES GLARE FREE LIGHTING WORK

Glare free lighting enhances visibility and minimizes glare for other road users.

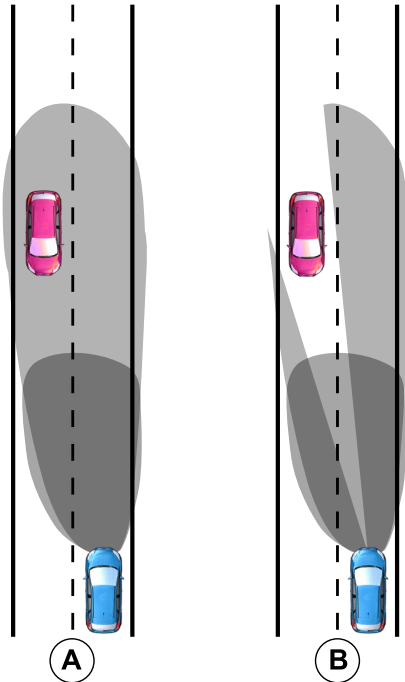

- A Without glare free lighting.
B With glare free lighting.

GLARE FREE LIGHTING PRECAUTIONS

⚠️ WARNING: The system does not relieve you of your responsibility to drive with due care and attention. You may need to override the system if it does not adapt the light.

⚠️ WARNING: The system may not adapt the lighting to avoid glare if the lights of oncoming vehicles are hidden by obstacles such as guard rails.

⚠️ WARNING: You may need to override the system when approaching other road users.

⚠️ WARNING: You may need to override the system during inclement weather.

⚠️ WARNING: Do not use the system in poor visibility, for example fog, heavy rain, spray or snow.

GLARE FREE LIGHTING REQUIREMENTS

The system turns on if all of the following occur:

- You switch the system on.
- You set the lighting control to the autolamps position.
- The ambient light level is low enough.
- Your vehicle speed is greater than approximately 32 mph (52 km/h).

Exterior Lighting

The system adapts the lighting to avoid glare if all of the following occur:

- You switch the system on.
- You set the lighting control to the autolamps position.
- The system detects an approaching vehicle's headlamps or rear lamps.

GLARE FREE LIGHTING LIMITATIONS

The system turns off if any of the following occur:

- You switch the system off.
- You set the lighting control to any position except autolamps.
- The ambient light level is high enough.
- The system detects severe rain, snow or fog.
- The system detects street lighting.
- The camera has reduced visibility.
- The vehicle speed falls below approximately 19 mph (30 km/h).

Note: *The deactivation speed is lower on curves.*

SWITCHING GLARE FREE LIGHTING ON AND OFF

1. Press **Settings** on the touchscreen.
2. Press **Vehicle Settings**.

3. Press **Lighting**.
4. Switch **Glarefree Lighting** on or off.

GLARE FREE LIGHTING INDICATORS



Illuminates to confirm when the system is ready to assist.

OVERRIDING GLARE FREE LIGHTING

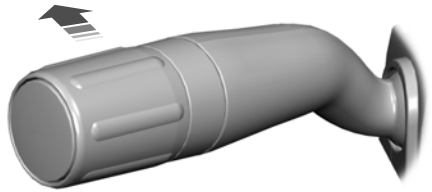

Push the lever away from you to switch the high beams on.

Push the lever away from you again to switch the high beams off.

Push the lever away from you for a third time to switch glare free lighting back on.

Exterior Lighting

GLARE FREE LIGHTING – TROUBLESHOOTING (IF EQUIPPED)

GLARE FREE LIGHTING – INFORMATION MESSAGES

| Message | Description |
|---|---|
| Front Camera Low Visibility Clean Screen | The camera has reduced visibility. Clean the windshield. If the message continues to appear, have your vehicle checked as soon as possible. |
| Front Camera Temporarily Not Available | The camera has malfunctioned. Wait a short period of time for the camera to cool down. If the message continues to appear, have your vehicle checked as soon as possible. |
| Front Camera Malfunction Service Required | The camera has malfunctioned. Have your vehicle checked as soon as possible. |

ADAPTIVE FRONT LIGHTING (IF EQUIPPED)

HOW DOES ADAPTIVE FRONT LIGHTING WORK

Adaptive front lighting adapts when you are steering around a curve or if the camera detects lane markings indicating a curve.

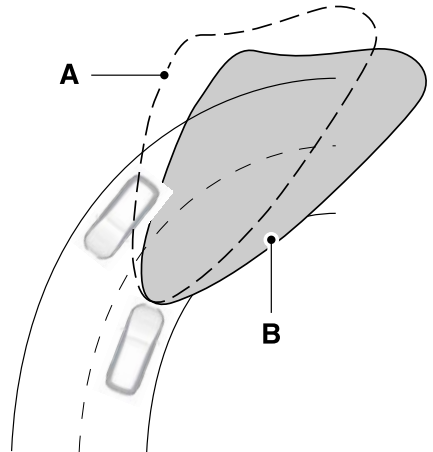

- A Without adaptive front lighting.
- B With adaptive front lighting.

Exterior Lighting

SWITCHING ADAPTIVE FRONT LIGHTING ON AND OFF

1. Press **Settings** on the touchscreen.
2. Press **Vehicle Settings**.
3. Press **Lighting**.
4. Switch **Adaptive Headlamps** on or off.

Set the lighting control to the autolamps position to use the adaptive front lighting.

Interior Lighting

SWITCHING ALL OF THE INTERIOR LAMPS ON AND OFF

The lamps turn on under the following conditions:

- You open any door.
- You press a button on the remote control.
- You press the all lamps on button on the overhead console.



Press to switch all interior lamps on or off.

SWITCHING THE FRONT INTERIOR LAMPS ON AND OFF



The front interior lamp switches are on the overhead console.

Note: *The position of each button on the overhead console depends on your vehicle.*

Individual Map Lamps



Press to switch the left-hand individual dome lamp on and off.



Press to switch the right-hand individual dome lamp on and off.

SWITCHING THE FRONT INTERIOR LAMPS ON AND OFF - POLICE RESPONDER



The front interior lamp switches are on the overhead console.

Note: *The position of each button on the overhead console depends on your vehicle.*

Night Vision Red Task Lamp



Press to switch the lamp on or off.

Individual Map Lamps



Press to switch the left-hand individual dome lamp on and off.



Press to switch the right-hand individual dome lamp on and off.

Interior Lighting

SWITCHING THE REAR INTERIOR LAMPS ON AND OFF



The rear interior lamps may be above the rear seat or above the rear windows.



Press to switch the lamps on or off.

Note: If you switch the rear lamps on through the overhead console, you cannot switch them off with the rear lamp switch.

INTERIOR LAMP FUNCTION

WHAT IS THE INTERIOR LAMP FUNCTION

The interior lamp function switches the courtesy and door lamps on or off.

SWITCHING THE INTERIOR LAMP FUNCTION ON AND OFF



Press to switch the interior lamp function on and off.

Note: The indicator lamp illuminates amber when the door function is off.

ADJUSTING THE INSTRUMENT PANEL LIGHTING BRIGHTNESS

The instrument lighting dimmer buttons are on the lighting control.



Repeatedly press one of the buttons to adjust the brightness.



AMBIENT LIGHTING

SWITCHING AMBIENT LIGHTING ON AND OFF

1. Press **Settings** on the touchscreen.
2. Press **Vehicle Settings**.
3. Press **Ambient Light**.
4. Switch **Ambient Light** on or off.

ADJUSTING AMBIENT LIGHTING

Drag the slider left or right.

INTERIOR LIGHTING – TROUBLESHOOTING

INTERIOR LIGHTING – FREQUENTLY ASKED QUESTIONS

Why do my courtesy lamps or interior lamps turn off when I have them switched on when I switch my vehicle off?

The battery saver turns the courtesy lamps and interior lamps off after a short period of time after you switch your vehicle off.

Windows

OPENING AND CLOSING THE WINDOWS



WARNING: Do not leave children unattended in your vehicle and do not let them play with the power windows. Failure to follow this instruction could result in personal injury.



WARNING: When closing the power windows, verify they are free of obstruction and make sure that children and pets are not in the proximity of the window openings.



Press the window control switch to open the window. Lift the window control switch to close the window.

Note: The power windows operate with the ignition on, and for several minutes after you switch the ignition off or until you open a front door.

To reduce wind noise or pulsing noise when one window is open, slightly open the opposite window.

One-Touch Open

Fully press the window control switch and release it. Press again or lift it to stop the window.

One-Touch Close

Fully lift the window control switch and release it. Press again or lift it to stop the window.

Resetting One-Touch Close

Carry out all steps within 30 seconds of starting the sequence.

1. Close the window.

2. Press and hold the window control switch until the window is fully open. Keep the window control switch pressed for a few seconds.
3. Lift and hold the window control switch until the window is fully closed. Keep the window control switch held for a few seconds.
4. Press and hold the window control switch until the window is fully open. Keep the window control switch pressed for a few seconds.
5. Lift and hold the window control switch until the window is fully closed. Keep the window control switch held for a few seconds.

Note: Repeat the procedure if the window does not close when you use one-touch.

WINDOW BOUNCE-BACK

WHAT IS WINDOW BOUNCE-BACK

The window stops and reverses if it detects an obstruction when closing.

OVERRIDING WINDOW BOUNCE-BACK



WARNING: If you override bounce-back, the window does not reverse if it detects an obstacle. Take care when closing the windows to avoid personal injury or damage to your vehicle.

1. Close the window until it reaches the point of resistance and let it reverse.
2. Lift and hold the window control switch within two seconds to override bounce-back and close the window. Bounce-back is now disabled and you can close the window manually.

Windows

Note: The window goes past the point of resistance and you can fully close it.

Note: If the window does not close, have your vehicle checked as soon as possible.

Press and hold the window control switch to open the window. Pull and hold the window control switch to close the window.

LOCKING THE REAR WINDOW CONTROLS (IF EQUIPPED)



Press the window control switch to lock or unlock the rear window controls. It illuminates when you lock the rear window controls.

OPENING AND CLOSING THE SLIDING WINDOWS (IF EQUIPPED)



WARNING: When closing the power windows, verify they are free of obstruction and make sure that children and pets are not in the proximity of the window openings.



WARNING: Do not leave children unattended in your vehicle and do not let them play with the power windows. Failure to follow this instruction could result in personal injury.

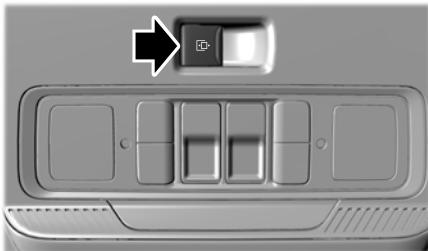

The window control switch is on the overhead console.

Interior Mirror

INTERIOR MIRROR PRECAUTIONS



WARNING: Do not adjust the mirrors when your vehicle is moving. This could result in the loss of control of your vehicle, serious personal injury or death.

Note: Do not clean the mirror housing or glass with harsh abrasives, fuel or other petroleum-based cleaning products.

MANUALLY DIMMING THE INTERIOR MIRROR

Pull the tab below the mirror toward you to reduce glare at night.

AUTO-DIMMING INTERIOR MIRROR (IF EQUIPPED)

WHAT IS THE AUTO-DIMMING INTERIOR MIRROR

The mirror dims to reduce the effect of bright light from behind. It returns to normal when the bright light from behind is no longer present or if you shift into reverse (R).

AUTO-DIMMING INTERIOR MIRROR LIMITATIONS

Do not block the sensors on the front and back of the mirror.

Note: A rear center passenger or raised rear center head restraint could prevent light from reaching the sensor.

Exterior Mirrors

ADJUSTING THE EXTERIOR MIRRORS



WARNING: Do not adjust the mirrors when your vehicle is moving. This could result in the loss of control of your vehicle, serious personal injury or death.

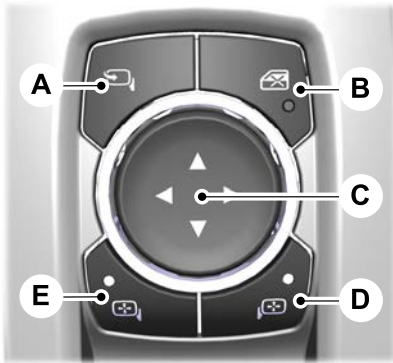

- A Power fold.
- B Window lock.
- C Adjustment control.
- D Right-hand mirror.
- E Left-hand mirror.

To adjust the mirrors, switch your vehicle on, with the ignition in accessory mode or the engine running:

1. Select the mirror you want to adjust. The control light turns on.
2. Use the adjustment control to adjust the position of the mirror.
3. Press the mirror control again. The control light turns off.

FOLDING THE EXTERIOR MIRRORS - VEHICLES WITH: MANUAL FOLDING MIRRORS

Push the mirror toward the door window glass.

Make sure that you fully engage the mirror in its support when returning it to its original position.

FOLDING THE EXTERIOR MIRRORS - VEHICLES WITH: POWER FOLDING MIRRORS

The exterior mirrors fold when you lock your vehicle and unfold when you unlock your vehicle.



For tight parking conditions, press the control to fold the mirrors.

Press the control switch again to unfold the mirrors.

Note: Do not stop the mirrors midway through their movement. Wait until the mirrors stop moving and press the control again.

The left-hand and right-hand mirrors move at different rates. For example, one mirror may stop while the other one continues to move. This is normal.

If you press the control switch to fold in the mirrors with auto-fold on, the mirrors do not unfold when you unlock your vehicle.

Note: The power folding mirrors operate with the ignition on, and for several minutes after you switch the ignition off.

Note: If you fold and unfold the mirrors several times within one minute, the power fold function may turn off to protect the motors from overheating.

Exterior Mirrors

Switching Auto-fold On and Off

1. Press **Settings** on the touchscreen.
2. Press **Vehicle Settings**.
3. Press **Mirrors**.
4. Switch **Autofold** on or off.

Loose Mirror

If your power-folding mirrors are manually folded, they may not work properly even after you re-position them. You need to reset them if:

- The mirrors vibrate when you drive.
- The mirrors feel loose.
- The mirrors do not stay in the folded or unfolded position.
- One of the mirrors is not in its normal driving position.

To reset the mirrors perform the following steps:

1. By hand, fold or retract both mirrors.
2. Using the power folding/power telescoping mirror control switch, operate the mirrors until you hear an audible click.
3. Operate the power folding or power telescoping mirrors an additional 3 to 4 times to synchronize the mirrors.

EXTENDING THE EXTERIOR MIRRORS

This optional feature lets you extend the mirror about 3 in (75 mm). It is useful when towing a trailer. You can manually pull out or push in the mirrors to various positions.

Power Telescoping Mirrors (if Equipped)

This feature lets you position both mirrors at the same time.



- A. Extend.
B. Retract.

To adjust your mirrors, make sure you switch your vehicle on, with the ignition in accessory mode or the engine running.

1. Press and release the control switch.
2. Press the adjustment control to position the mirrors.
3. Press the left arrow to extend the mirrors out. Press the right arrow to retract the mirrors in.

Note: Moving the mirrors 10 or more times within one minute, or repeated folding and unfolding of the mirrors when holding the control down during full travel, could disable the system to protect the motors from overheating. Wait approximately three minutes with the vehicle running, and up to 10 minutes with the vehicle off, for the system to reset and for function to return to normal.

AUTO-DIMMING EXTERIOR MIRROR (IF EQUIPPED)

WHAT IS THE AUTO-DIMMING EXTERIOR MIRROR

The driver exterior mirror dims when the interior auto-dimming mirror turns on.

Moonroof (If Equipped)

OPENING AND CLOSING THE SUN SHADE



WARNING: Do not leave children unattended in your vehicle and do not let them play with the sun shades. Failure to follow this instruction could result in personal injury.

The controls are on the overhead console.

Opening the Sun Shade



Press and release the switch to activate the one-touch open feature. To stop movement, press the switch a second time. The sun shade also opens when you open the moonroof.

Note: *The sun shade stops short of its fully opened position for the comfort of rear passengers. To fully open the sun shade, press the switch again.*

Closing the Sun Shade



Press and release the switch to activate the one-touch close feature. To stop movement, press the switch a second time.

OPENING AND CLOSING THE MOONROOF



WARNING: Do not leave children unattended in your vehicle and do not let them play with the moonroof. Failure to follow this instruction could result in personal injury.



WARNING: When closing the moonroof, verify that it is free of obstruction and make sure that children and pets are not in the proximity of the roof opening.

The controls are on the overhead console.

Opening the Moonroof



Press and release the switch to activate the one-touch open feature. To stop movement, press the switch a second time.

Note: *The moonroof stops short of the fully opened position to reduce wind noise or rumbling that may happen with the moonroof fully open.*

Press and release the switch again to fully open the moonroof.

Closing the Moonroof



Press and release the switch to activate the one-touch close feature, from either the open or vent positions. To stop movement, press the switch a second time.

VENTING THE MOONROOF



WARNING: Do not leave children unattended in your vehicle and do not let them play with the moonroof. Failure to follow this instruction could result in personal injury.

The moonroof controls are on the overhead console.

Moonroof (If Equipped)



With the moonroof in the closed position, press and release the switch to vent the moonroof. To close the moonroof from the vent position, press and release the switch again.

MOONROOF BOUNCE-BACK

WHAT IS MOONROOF BOUNCE-BACK

The moonroof stops and reverses some distance if it detects an obstacle when closing.

OVERRIDING MOONROOF BOUNCE-BACK

Press and hold the close button within two seconds after the moonroof comes to a stop.

Instrument Cluster

INSTRUMENT CLUSTER OVERVIEW - VEHICLES WITH: 4.2 INCH SCREEN

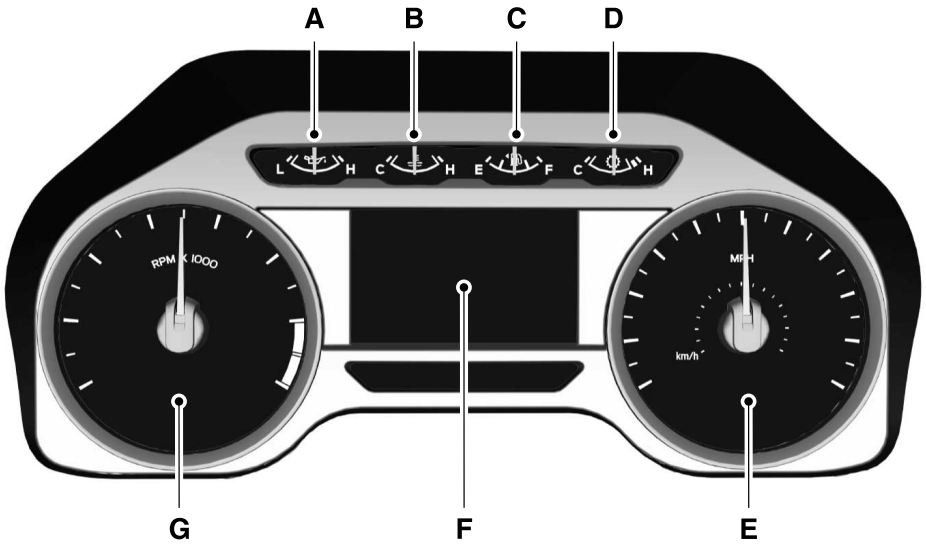

- A Engine oil pressure gauge.
- B Engine coolant temperature gauge.
- C Fuel gauge.
- D Transmission fluid temperature gauge.
- E Speedometer.
- F Information display.
- G Tachometer.

Instrument Cluster

INSTRUMENT CLUSTER OVERVIEW - VEHICLES WITH: 8 INCH SCREEN

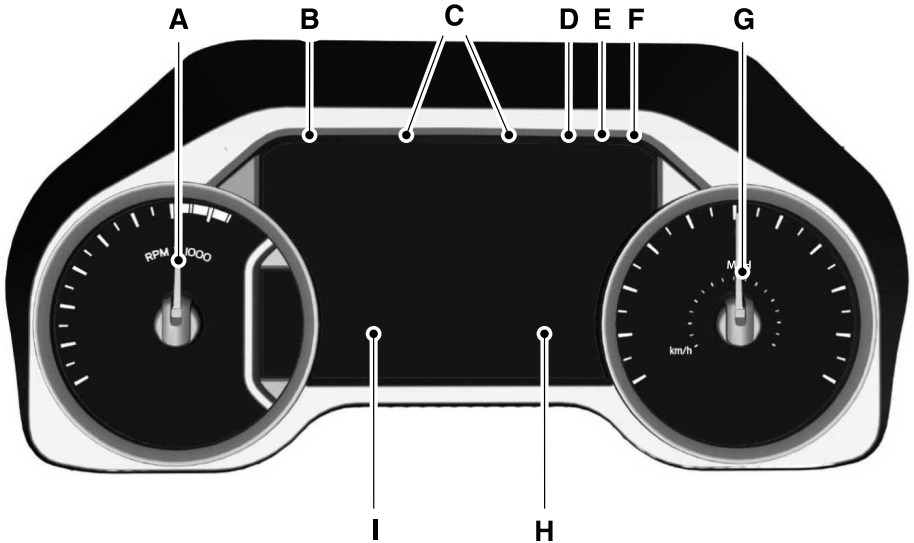

- A Tachometer.
- B Engine coolant temperature gauge.
- C Configurable gauges. Oil pressure, transmission oil temperature, turbo boost, or diesel exhaust fluid level gauges.
- D Compass.
- E Fuel gauge.
- F Ambient temperature.
- G Speedometer.
- H Distance to empty.
- I Odometer.

Instrument Cluster

INSTRUMENT CLUSTER OVERVIEW - VEHICLES WITH: 12.3 INCH SCREEN

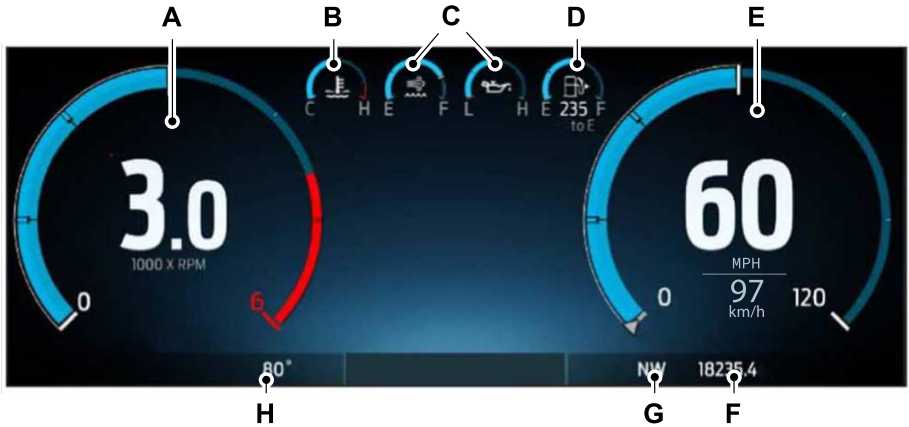

- A Tachometer.
- B Engine coolant temperature gauge.
- C Configurable gauges. Oil pressure, transmission oil temperature, turbo boost, vacuum/boost, battery voltage, air charge temperature, engine oil temperature or diesel exhaust fluid level gauges.
- D Fuel gauge.
- E Speedometer.
- F Odometer.
- G Compass.
- H Ambient temperature.

TACHOMETER

Indicates the engine speed.

SPEEDOMETER

Indicates the vehicle speed.

FUEL GAUGE

WHAT IS THE FUEL GAUGE

Indicates approximately how much fuel is in the fuel tank.

Instrument Cluster

FUEL GAUGE LIMITATIONS

The fuel gauge may not provide an accurate reading when your vehicle is on an incline.

LOCATING THE FUEL FILLER DOOR

The arrow adjacent to the fuel pump symbol indicates on which side of your vehicle the fuel filler door is located.

WHAT IS THE LOW FUEL REMINDER

A low fuel level reminder displays and sounds when the distance to empty reaches 75 mi (120 km) to empty for MyKey, and at 50 mi (80 km), 25 mi (40 km), 12 mi (20 km) and 0 mi (0 km) for all vehicle keys.

Note: *The low fuel reminder can appear at different fuel gauge positions depending on fuel economy conditions. This variation is normal.*

WHAT IS DISTANCE TO EMPTY

Indicates the approximate distance your vehicle can travel on the fuel remaining in the tank. Changes in driving pattern can cause the value to not only decrease but also increase or stay constant for periods of time.

ENGINE COOLANT TEMPERATURE GAUGE

Indicates the engine coolant temperature.

ENGINE OIL PRESSURE GAUGE

Indicates the engine oil pressure.

Note: *This is a configurable gauge.*

TRANSMISSION FLUID TEMPERATURE GAUGE

Indicates the transmission fluid temperature.

Special operating conditions can cause higher than normal operating temperatures. See **Special Operating Conditions Scheduled Maintenance** (page 648).

Note: *This is a configurable gauge.*

TURBO BOOST GAUGE (IF EQUIPPED)

Indicates the amount of manifold air pressure in the engine.

Note: *This is a configurable gauge.*

WHAT ARE THE INSTRUMENT CLUSTER WARNING LAMPS

Warning lamps alert you to a vehicle condition that could become serious. Some lamps illuminate when you start your vehicle to make sure they work. If any lamps remain on after starting your vehicle, refer to the respective system warning lamp for further information.

INSTRUMENT CLUSTER WARNING LAMPS

Anti-Lock Brake System



If it illuminates when you are driving, this indicates a concern. Your vehicle continues to have normal braking without the anti-lock brake system function. Have your vehicle checked as soon as possible.

Instrument Cluster

Battery



It illuminates when you switch the ignition on.

If it illuminates when the engine is running, this indicates your vehicle requires service. Have your vehicle checked as soon as possible.

Brake System



It illuminates when you apply the parking brake and the ignition is on. If it illuminates when your vehicle is moving, make sure the parking brake is released. If the parking brake is released, this indicates low brake fluid level or the brake system requires service. Have your vehicle checked as soon as possible.



If it illuminates when your vehicle is moving, make sure the parking brake is released. If the parking brake is released, this indicates low brake fluid level or the brake system requires service. Have your vehicle checked as soon as possible.

Note: Indicators may vary depending on region.

Door Ajar



It illuminates when you switch the ignition on and remains on if any door is open.

Electric Parking Brake



It illuminates or flashes when the electric parking brake requires service.

Engine Coolant Temperature



If it illuminates, safely stop your vehicle and switch the vehicle off.

Fasten Seatbelt



It illuminates and a tone sounds until you fasten the seatbelts.

Hood Ajar



It illuminates when the ignition is on and the hood is not completely closed.

Low Fuel Level



It illuminates when the fuel level is low.

Low Tire Pressure



It illuminates when your tire pressure is low. If illuminated, check your tire pressure as soon as possible. If it begins to flash at any time, have the system checked as soon as possible.

Low Washer Fluid Level



It illuminates when the washer fluid is low.

Oil Pressure



It illuminates when the engine oil pressure is low.

Powertrain Malfunction, Reduced Power, Electronic Throttle Control, Check 4X4



It illuminates when the powertrain or four-wheel drive require service. Have the system checked as soon as possible.

Instrument Cluster

Malfunction Indicator Lamp



It illuminates when the ignition is on and the engine is off, this is normal. If it illuminates when the engine is on this indicates the emission control system requires service. If it flashes, have your vehicle checked immediately. See **Emission Law** (page 714). See **Starting and Stopping the Engine – Warning Lamps** (page 238).

Stop Safely



Illuminates if an electrical component requires service or a failure that causes your vehicle to shutdown or enter into a limited operating mode.

Tailgate Ajar



It illuminates when the ignition is on and the tailgate is not completely closed.

WHAT ARE THE INSTRUMENT CLUSTER INDICATORS

Indicators notify you of various features that are active on your vehicle.

INSTRUMENT CLUSTER INDICATORS

Adaptive Cruise Control



See **Adaptive Cruise Control** (page 331).

Automatic High Beam



See **Automatic High Beam Control Indicators** (page 152).

Auto Hold Active



See **Auto Hold** (page 297).

Auto Hold Unavailable



See **Auto Hold** (page 297).

Auto-Start-Stop



See **Auto-Start-Stop** (page 244).

Blind Spot Monitor



See **Blind Spot Information System** (page 368).

BlueCruise



See **BlueCruise** (page 344).

Cruise Control



See **Cruise Control** (page 329).

Electronic Locking Differential



See **Electronic Locking Differential** (page 279).

Instrument Cluster

Four-Wheel Drive



See **Four-Wheel Drive** (page 269).



Note: Some indicators appear different depending on vehicle options.

Front Airbag



See **Airbags** (page 70).

Front Fog Lamp



See **Switching the Front Fog Lamps On and Off** (page 148).

High Beam



See **Using the High Beam Headlamps** (page 145).

Hill Descent



See **Hill Descent Control** (page 309).

Lamps On



See **Exterior Lighting Control** (page 145).

Ready to Drive



See **Hybrid Electric Vehicle Information** (page 241).

Reverse Brake Assist



See **Reverse Braking Assist** (page 292).

Stability Control and Traction Control



See **Traction Control** (page 298). See **Stability Control** (page 300).



Turn Signal Lamps



See **Switching the Turn Signal Lamps On and Off** (page 147).

Tow Haul



See **Towing a Trailer** (page 403).

Instrument Cluster Display

USING THE INSTRUMENT CLUSTER DISPLAY CONTROLS



WARNING: Driving while distracted can result in loss of vehicle control, crash and injury. We strongly recommend that you use extreme caution when using any device that may take your focus off the road. Your primary responsibility is the safe operation of your vehicle. We recommend against the use of any hand-held device while driving and encourage the use of voice-operated systems when possible. Make sure you are aware of all applicable local laws that may affect the use of electronic devices while driving.

The controls are on the steering wheel.

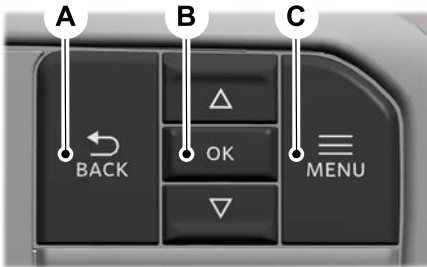

- A Back button.
- B OK button.
- C Menu button.

Back Button

Press to go back or to exit a menu.

OK Button

Press to make a selection.

Menu Button

Press to display the submenu.

Scroll Buttons

Press the up or down buttons to scroll through the menu items.

Status Indicator



Menu items with a check box indicates a feature's status. A check in the box indicates the feature is on, and unchecked indicates the feature is off.

INSTRUMENT CLUSTER DISPLAY MAIN MENU - VEHICLES WITH: 12.3 INCH SCREEN

Depending on your vehicle options, some menu items can appear different or not at all.

Note: For your safety, some features are speed-dependent and could be unavailable when your vehicle is above a certain speed.

| Menu Item |
|------------|
| MyView |
| Trip/Fuel |
| Truck Info |
| Towing |
| Navigation |
| Phone |
| Audio |
| Settings |

Instrument Cluster Display

INSTRUMENT CLUSTER DISPLAY MAIN MENU - RAPTOR

Depending on your vehicle options, some menu items can appear different or not at all.

Note: For your safety, some features are speed-dependent and could be unavailable when your vehicle is above a certain speed.

| Menu Item |
|-------------|
| MyView |
| Trip/Fuel |
| Raptor Info |
| Towing |
| Navigation |
| Phone |
| Audio |
| Settings |

INSTRUMENT CLUSTER DISPLAY MAIN MENU - VEHICLES WITH: 4.2 INCH SCREEN

Depending on your vehicle options, some menu items can appear different or not at all.

Note: For your safety, some features are speed-dependent and could be unavailable when your vehicle is above a certain speed.

| Menu Item |
|----------------|
| Select Screens |
| Truck Info |
| Towing |
| Settings |

INSTRUMENT CLUSTER DISPLAY MAIN MENU - VEHICLES WITH: 8 INCH SCREEN

Depending on your vehicle options, some menu items can appear different or not at all.

Note: For your safety, some features are speed-dependent and could be unavailable when your vehicle is above a certain speed.

| Menu Item |
|------------|
| MyView |
| Trip/Fuel |
| Truck Info |
| Towing |
| Navigation |
| Phone |
| Audio |
| Settings |

Instrument Cluster Display

TRIP COMPUTER - VEHICLES WITH: 4.2 INCH SCREEN

ACCESSING THE TRIP COMPUTER

Using Select Screens

1. Select **Select Screens**.
2. Use the controls on the steering wheel to navigate the menu. See **Customizing the Instrument Cluster Display** (page 175).

Using the Home Screen

Once screens have been added, use the controls on the steering wheel to view each trip screen.

RESETTING THE TRIP COMPUTER

1. Use the controls on the steering wheel to navigate the home screen.
2. Select **Trip 1** or **Trip 2**.
3. Press and hold the **OK** button for a few seconds.

Note: *This Trip resets every time you start your vehicle.*

TRIP COMPUTER - VEHICLES WITH: 8 INCH SCREEN/12.3 INCH SCREEN

ACCESSING THE TRIP COMPUTER

1. Select **Trip/Fuel**.
2. Select **This Trip, Trip 1** or **Trip 2**.

RESETTING THE TRIP COMPUTER

1. Select **Trip/Fuel**.
2. Select **Trip 1** or **Trip 2**.

3. Press and hold the **OK** button for a few seconds.

Note: *This Trip resets every time you start your vehicle.*

CUSTOMIZING THE INSTRUMENT CLUSTER DISPLAY

Adding Screens Using MyView

1. Using the information display controls on the steering wheel, select **MyView**.
2. Select **Configure MyView**.
3. Select a screen.
4. Press the **OK** button.

Note: *The number of screens you can add is limited. If the selected screen does not appear you must deselect screens from the MyView menu.*

Adding Screens Using Select Screens

1. Select **Select Screens**.
2. Use the controls on the steering wheel to highlight a screen to add.
3. Press the **OK** button.

Note: *The number of screens you can add is limited. If the selected screen does not appear you must deselect screens from the Select Screens menu.*

Configuring Gauges

1. Select **Settings**.
2. Select **Configure Gauges**.
3. Select to swap or change left-hand side and right-hand side gauges.

Instrument Cluster Display

PERSONALIZED SETTINGS

CHANGING THE MEASUREMENT UNIT

1. Press **Settings** on the touchscreen.
2. Press **General**.
3. Press **Measure Units**.
4. Select a measurement unit.

CHANGING THE TEMPERATURE UNIT

1. Press **Settings** on the touchscreen.
2. Press **General**.
3. Press **Temperature Units**.
4. Select **Fahrenheit** or **Celsius**.

CHANGING THE TIRE PRESSURE UNIT

1. Press **Settings** on the touchscreen.
2. Press **General**.
3. Press **Tire Pressure Units**.
4. Select a pressure unit.

HYBRID DISPLAY INFORMATION

WHAT IS EV COACH

EV coach helps you get the most of your vehicle's electrical driving and regenerative braking capabilities.

HOW DOES EV COACH WORK

When accelerating or maintaining speed, a blue or white solid bar displays. This indicates vehicle power. A blue rectangular box could also display that shows the power level that the engine turns on at.

When the power level displays in the rectangular box, it is blue which indicates you are in electric only operation.

When the power level displays outside of the rectangular box, it is white which indicates you are in hybrid operation.

When you are decelerating, either releasing the accelerator pedal or applying the brake, you see a green or white solid bar which indicates the power being used to slow your vehicle down. A green rectangular box could also display that shows the amount of power that can be recaptured by the regenerative braking system and returned to the high voltage battery.

When the power level displays in the rectangular box, it is green which indicates that the regenerative braking system is being used to slow down your vehicle and return the maximum amount of energy to the high voltage battery.

When the power level displays outside of the rectangular box, it is white which indicates both regenerative and conventional braking systems are in use.

WHAT IS BRAKE COACH

The brake coach appears after the vehicle has come to a stop. It coaches you to brake in a manner that maximizes the amount of energy returned through the regenerative braking system.

The percent displayed is an indication of the regenerative braking efficiency with 100% representing the maximum amount of energy recovery. You can switch brake coach on or off in the settings menu on your touchscreen.

Instrument Cluster Display

WHAT IS THE TRIP SUMMARY

Displays the trip summary when you switch off your vehicle. The values are cumulative since you last started your vehicle.

Remote Start (If Equipped)

WHAT IS REMOTE START

The system allows you to remotely start your vehicle and to adjust the interior temperature according to the settings that you chose.

REMOTE START PRECAUTIONS



WARNING: Do not start the engine in a closed garage or in other enclosed areas. Exhaust fumes are toxic. Always open the garage door before you start the engine. Failure to follow this instruction could result in personal injury or death.



WARNING: Do not keep electrical devices plugged in the power point whenever the device is not in use. Power points power up during remote start.



WARNING: Do not keep electrical devices plugged into the power outlet whenever the device is not in use. The outlet provides power when the vehicle is on. Failure to follow this instruction could result in personal injury.

REMOTE START LIMITATIONS

Remote start does not work under the following conditions:

- The alarm horn is sounding.
- The hood is open.
- The transmission is not in park (P).
- The ignition is on.
- The battery voltage is below the minimum operating voltage.
- Remote start is not enabled.

Note: Do not use remote start if the fuel level is low.

Note: You can use remote start with FordPass. See **Connecting the Vehicle to a Wi-Fi Network** (page 597).

ENABLING REMOTE START

1. Press **Settings** on the touchscreen.
2. Press **Vehicle Settings**.
3. Press **Remote Start Setup**.
4. Switch **Remote Start** on or off.

Note: To remote start with FordPass, make sure that the modem is enabled. See **Connecting FordPass to the Modem** (page 597).

REMOTELY STARTING AND STOPPING THE VEHICLE

Remotely Starting the Vehicle



Press the button on the remote control.



Within three seconds, press the button on the remote control.

Within three seconds, press the button again.

Note: You can also use FordPass to start the vehicle.

Note: The turn signal lamps flash twice.

Note: The parking lamps turn on when the vehicle is running.

Note: The horn sounds if the system fails to start.

Note: All other vehicle systems remain off when you have remotely started the vehicle.

Remote Start (If Equipped)

Note: The vehicle remains secured when you have remotely started the vehicle. A valid key must be inside your vehicle to switch the ignition on and drive your vehicle.

Remotely Stopping the Vehicle



Within three seconds, press the button on the remote control.

Within three seconds, press the button again.

EXTENDING THE REMOTE START DURATION

To extend the remote start duration during remote start, do the following:



Press the button on the remote control.



Within three seconds, press the button on the remote control.

Within three seconds, press the button again.

If the duration is set to 15 minutes, the duration extends by another 15 minutes. This provides a total of 30 minutes.

Note: Remote start can only be extended once.

Note: A maximum of two remote starts, or one remote start with an extension, are allowed. To reset the restart procedure switch the vehicle to on, then to off.

REMOTE START REMOTE CONTROL INDICATORS

Remote Control Feedback

An LED on the remote control provides status feedback of remote start or stop commands.

| LED | Status |
|-----------------|--|
| Solid green. | Remote start successful. |
| Solid red. | Remote stop successful. |
| Blinking red. | Request failed or status not received. |
| Blinking green. | Status incomplete. |

REMOTE START SETTINGS

SWITCHING CLIMATE CONTROL AUTO MODE ON AND OFF

1. Press **Settings** on the touchscreen.
2. Press **Remote Start Setup**.
3. Press **Climate Control**.
4. Select **Vehicle**.
5. Switch **Auto** on or off.

Note: If you switch the auto mode on, the system attempts to heat or cool the interior to 72°F (22°C).

Note: When you switch the ignition on, the climate control system returns to the last used settings.

SWITCHING CLIMATE CONTROL LAST SETTINGS ON AND OFF

1. Press **Settings** on the touchscreen.
2. Press **Vehicle Settings**.
3. Press **Remote Start Setup**.
4. Switch **Last settings** on or off.

Note: If you switch the last settings on, the system remembers the last used settings.

Remote Start (If Equipped)

SWITCHING THE HEATED SEAT SETTINGS ON AND OFF

1. Press **Settings** on the touchscreen.
2. Press **Vehicle Settings**.
3. Press **Remote Start Setup**.
4. Press **Seats**.
5. Switch **Auto** on or off.

Note: *If you switch the heated seat settings on, the heated seats turn on during cold weather.*

SWITCHING THE HEATED STEERING WHEEL SETTINGS ON AND OFF

1. Press **Settings** on the touchscreen.
2. Press **Vehicle Settings**.
3. Press **Remote Start Setup**.
4. Press **Seats and Steering Wheel**.
5. Switch **Auto** on or off.

Note: *If you switch the heated steering wheel settings on, the heated steering wheel turns on during cold weather.*

SETTING THE REMOTE START DURATION

1. Press **Settings** on the touchscreen.
2. Press **Vehicle Settings**.
3. Press **Remote Start Setup**.
4. Press **Duration**.

Note: *Wait a few seconds before remotely starting the vehicle after the vehicle stops running.*

Climate Control - Vehicles With: Automatic Temperature Control

IDENTIFYING THE CLIMATE CONTROL UNIT



Depending on your vehicle options, the controls could look different than what you see here.

SWITCHING CLIMATE CONTROL ON AND OFF



Press the button.

SWITCHING RECIRCULATED AIR ON AND OFF



Press the button to recirculate air currently in the passenger compartment.

Note: *Recirculated air may turn off automatically, or prevent you from switching on in all air flow modes except MAX A/C to reduce the risk of fogging. Recirculation may also turn on and off automatically in various air distribution control combinations to improve heating or cooling efficiency.*

SWITCHING AIR CONDITIONING ON AND OFF



Press the button.

Note: *Under certain conditions, the air conditioning compressor could continue to operate after you switch air conditioning off.*

Note: *To keep the system and its components fully functional, switch air conditioning on and let your vehicle idle at least once per month for a minimum of two minutes.*

SWITCHING DEFROST ON AND OFF



Press the button to activate the selection screen.



Press the button on the touchscreen to switch the windshield air vents on.



Make sure that the instrument panel air vents are switched off.



Make sure that the footwell air vents are switched off.

SWITCHING MAXIMUM DEFROST ON AND OFF



Press the button.

Air flows through the windshield air vents, and the blower motor adjusts to the highest speed.

You can also use this setting to defog and clear the windshield of a thin covering of ice.

Note: *To prevent window fogging, you cannot select recirculated air when maximum defrost is on.*

Note: *The heated rear window also turns on when you select maximum defrost.*

Climate Control - Vehicles With: Automatic Temperature Control

Note: When maximum defrost is on, the air conditioning compressor may continue to operate even though you switch off the air conditioning.

SWITCHING MAXIMUM COOLING ON AND OFF

 Press the button.

Note: When you switch maximum cooling off, air conditioning remains on.

SWITCHING THE HEATED WIPER PARK ON AND OFF (IF

EQUIPPED)

 When you switch the heated rear window on, the heated wiper park also turns on.

SWITCHING THE HEATED REAR WINDOW ON AND OFF

 Press the button to clear the rear window of thin ice and fog. The heated rear window turns off after a short period of time.

Note: Do not use harsh chemicals, razor blades or other sharp objects to clean or remove decals from the inside of the heated rear window as this could cause damage to the heated rear window grid lines not covered by the vehicle Warranty.

SETTING THE BLOWER MOTOR SPEED



Press up or down on the control to select the blower motor speed.

Note: For Hybrid Electric Vehicle (HEV) and Plug-In Hybrid Electric Vehicle (PHEV) vehicles, the blower motor may run, and you may feel airflow when the climate control is off to provide cooling to the battery.

SWITCHING THE HEATED MIRRORS ON AND OFF



Press the button.

SETTING THE TEMPERATURE

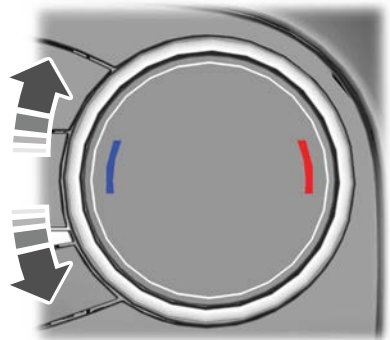

Turn the control on the left-hand side of the climate control to set the left-hand temperature.

Climate Control - Vehicles With: Automatic Temperature Control

Note: This control also sets the right-hand side temperature when you switch off dual zone mode.

Turn the control on the right-hand side of the climate control to set the right-hand temperature.

DIRECTING THE FLOW OF AIR

Directing Air to the Windshield Air Vents



Press the button to activate the selection screen.



Press the button on the touchscreen.

Directing Air to the Instrument Panel Air Vents



Press the button to activate the selection screen.



Press the button on the touchscreen.

Directing Air to the Footwell Air Vents



Press the button to activate the selection screen.



Press the button on the touchscreen.

AUTO MODE

SWITCHING AUTO MODE ON AND OFF



Press the button to switch auto mode on. Repeatedly press the button to adjust auto mode.

Note: When you switch auto mode on, lights on the blower motor control do not illuminate to indicate the blower motor speed.

Adjust the blower motor control or air distribution control to switch auto mode off.

AUTO MODE INDICATORS

The indicators are on the Auto Mode button.

| Auto Mode Indicator Status | Description |
|-------------------------------|--|
| One indicator illuminated. | The blower motor speed is reduced. Use this setting to minimize the amount of noise from the blower motor. This setting increases the time taken to cool the interior. |
| Two indicators illuminated. | The blower motor speed is moderate. |
| Three indicators illuminated. | The blower motor speed is increased. Use this setting to reduce the time taken to cool the interior. This setting increases the amount of noise from the blower motor. |

Climate Control - Vehicles With: Automatic Temperature Control

SWITCHING DUAL MODE ON AND OFF



Press the button.

CLIMATE CONTROL HINTS

General Hints

- Prolonged use of recirculated air may cause the windows to fog up.
- You may feel a small amount of air from the footwell air vents regardless of the air distribution setting.
- To reduce humidity build-up inside your vehicle, do not drive with the system switched off or with recirculated air always switched on.
- Do not place objects under the front seats as this may interfere with the airflow to the rear seats.
- Remove any snow, ice or leaves from the air intake area at the base of the windshield.
- To improve the time to reach a comfortable temperature in hot weather, drive with the windows open until you feel cold air through the air vents.

Automatic Climate Control

- Adjusting the settings when your vehicle interior is extremely hot or cold is not necessary. Automatic mode is best recommended to maintain set temperature.
- The system adjusts to heat or cool the interior to the temperature you select as quickly as possible.
- For the system to function efficiently, the instrument panel and side air vents should be fully open.

- If you press **AUTO** during cold outside temperatures, the system directs air flow to the windshield and side window air vents. In addition, the blower motor may run at a slower speed until the engine warms up.
- If you press **AUTO** during hot temperatures and the inside of the vehicle is hot, the system uses recirculated air to maximize interior cooling. Blower motor speed may also reduce until the air cools.

Quickly Heating the Interior

1. Press **AUTO**.
2. Adjust the temperature function to the setting you prefer.

Recommended Settings for Heating

1. Press **AUTO**.
2. Adjust the temperature function to the setting you prefer. Use 72°F (22°C) as a starting point, then adjust the setting as necessary.

Quickly Cooling the Interior

1. Press **MAX A/C**.
2. Drive with the windows open for a short period of time.

Recommended Settings for Cooling

1. Press **AUTO**.
2. Adjust the temperature function to the setting you prefer. Use 72°F (22°C) as a starting point, then adjust the setting as necessary.

Defogging the Side Windows in Cold Weather

1. Press and release defrost or maximum defrost.

Climate Control - Vehicles With: Automatic Temperature Control

2. Adjust the temperature control to the setting you prefer. Use 72°F (22°C) as a starting point, then adjust the setting as necessary.

Climate Control - Vehicles With: Manual Temperature Control

IDENTIFYING THE CLIMATE CONTROL UNIT



Depending on your vehicle options, the controls could look different than what you see here.

SWITCHING CLIMATE CONTROL ON AND OFF



Press the button.

SWITCHING RECIRCULATED AIR ON AND OFF



Press the button to recirculate air currently in the passenger compartment.

Note: Recirculated air may turn off automatically, or prevent you from switching on in all air flow modes except MAX A/C to reduce the risk of fogging. Recirculation may also turn on and off automatically in various air distribution control combinations to improve heating or cooling efficiency.

SWITCHING AIR CONDITIONING ON AND OFF



Press the button.

Note: Under certain conditions, the air conditioning compressor could continue to operate after you switch air conditioning off.

Note: To keep the system and its components fully functional, switch air conditioning on and let your vehicle idle at least once per month for a minimum of two minutes.

SWITCHING DEFROST ON AND OFF



Press the button to switch the windshield air vents on.



Make sure that the instrument panel air vents are switched off.



Make sure that the footwell air vents are switched off.

SWITCHING MAXIMUM DEFROST ON AND OFF



Turn the temperature control clockwise past the highest setting to maximize defrosting.

Note: The temperature control springs back to the highest setting.

Air flows through the windshield air vents, and the blower motor adjusts to the highest speed.

Note: To prevent window fogging, you cannot select recirculated air when maximum defrost is on.

Note: The heated rear window also turns on when you select maximum defrost.

Climate Control - Vehicles With: Manual Temperature Control

SWITCHING MAXIMUM COOLING ON AND OFF

 Turn the temperature control counterclockwise past the lowest setting to maximize cooling.

Note: *The temperature control springs back to the lowest setting.*

Note: *When you switch maximum cooling off, air conditioning remains on.*

SWITCHING THE HEATED REAR WINDOW ON AND OFF

 Press the button to clear the rear window of thin ice and fog. The heated rear window turns off after a short period of time.

Note: *Do not use harsh chemicals, razor blades or other sharp objects to clean or remove decals from the inside of the heated rear window as this could cause damage to the heated rear window grid lines not covered by the vehicle Warranty.*

SETTING THE BLOWER MOTOR SPEED



Note: *Lights on the control illuminate to indicate the blower motor speed.*

Note: *When you switch the blower motor off, air conditioning turns off and the windows could fog up.*

SWITCHING THE HEATED MIRRORS ON AND OFF



Press the button.

SETTING THE TEMPERATURE

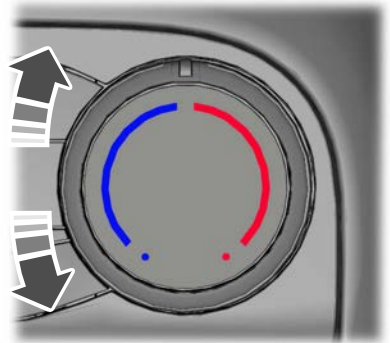

Turn the temperature control counterclockwise for cooler temperature settings.

Turn the temperature control clockwise for warmer temperature settings.

DIRECTING THE FLOW OF AIR

Directing Air to the Windshield Air Vents



Press the button.

Directing Air to the Instrument Panel Air Vents



Press the button.

Climate Control - Vehicles With: Manual Temperature Control

Directing Air to the Footwell Air Vents



Press the button.

CLIMATE CONTROL HINTS

General Hints

- Prolonged use of recirculated air may cause the windows to fog up.
- You may feel a small amount of air from the footwell air vents regardless of the air distribution setting.
- To reduce humidity build-up inside your vehicle, do not drive with the system switched off or with recirculated air always switched on.
- Do not place objects under the front seats as this may interfere with the airflow to the rear seats.
- Remove any snow, ice or leaves from the air intake area at the base of the windshield.
- To improve the time to reach a comfortable temperature in hot weather, drive with the windows open until you feel cold air through the air vents.

Quickly Heating the Interior

1. Adjust the blower motor speed to the highest speed setting.
2. Adjust the temperature control to the highest setting.
3. Direct air to the footwell air vents.

Recommended Settings for Heating

1. Adjust the blower motor speed to the center setting.

2. Adjust the temperature control to the midway point of the hot settings.
3. Direct air to the footwell air vents.

Quickly Cooling the Interior

1. Press **MAX A/C**.
2. Drive with the windows open for a short period of time.

Recommended Settings for Cooling

1. Adjust the blower motor speed to the center setting.
2. Adjust the temperature control to the midway point of the cold settings.
3. Direct air to the instrument panel air vents.

Defogging the Side Windows in Cold Weather

1. Direct air to the instrument panel and windshield air vents.
2. Press and release **A/C**.
3. Adjust the temperature control to the setting you prefer.
4. Adjust the blower motor speed to the highest setting.
5. Direct air toward the side windows.
6. Close the instrument panel air vents.

Interior Air Quality

WHAT IS THE CABIN AIR FILTER

The cabin air filter improves the quality of air in your vehicle by trapping dust, pollen and other particles.

REPLACING THE CABIN AIR FILTER

Replace the filter at regular intervals. See **Scheduled Maintenance** (page 642).

The cabin air filter is behind the glove compartment.

To remove the lower glove compartment and access the filter:

1. Open the glove compartment.

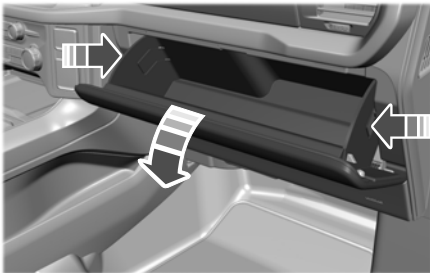

2. Press the tab on each side.
3. Fully lower the glove compartment.
4. Pull the glove compartment toward you.

Front Seats

FRONT SEAT PRECAUTIONS

WARNING: Sitting improperly, out of position or with the seatback reclined too far can take weight off the seat cushion and affect the decision of the passenger sensing system, resulting in serious injury or death in the event of a crash. Always sit upright against your seat back, with your feet on the floor.

WARNING: Do not recline the seat backrest too far as this can cause the occupant to slide under the seatbelt, resulting in personal injury in the event of a crash.

WARNING: Do not place objects higher than the top of the seat backrest. Failure to follow this instruction could result in personal injury or death in the event of a sudden stop or crash.

WARNING: Do not adjust the driver seat or seat backrest when your vehicle is moving. This may result in sudden seat movement, causing the loss of control of your vehicle.

SITTING IN THE CORRECT POSITION

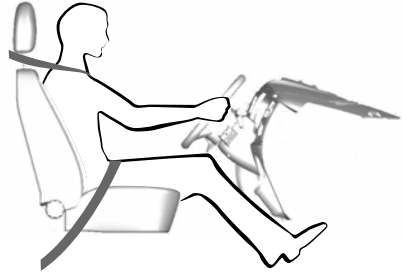

When you use them properly, the seat, head restraint, seatbelt and airbags will provide optimum protection in the event of a crash.

We recommend that you follow these guidelines:

- Sit in an upright position with the base of your spine as far back as possible.
- Do not recline the seat backrest so that your torso is more than 30 degrees from the upright position.
- Adjust the head restraint so that the top of it is level with the top of your head and as far forward as possible. Make sure that you remain comfortable.
- Keep sufficient distance between yourself and the steering wheel. We recommend a minimum of 10 in (25 cm) between your breastbone and the airbag cover.
- Hold the steering wheel with your arms slightly bent.

Front Seats

- Bend your legs slightly so that you can press the pedals fully.
- Position the shoulder strap of the seatbelt over the center of your shoulder and position the lap strap tightly across your hips.

Make sure that your driving position is comfortable and that you can maintain full control of your vehicle.

MANUAL SEATS (IF EQUIPPED)

HEADRESTRAINT COMPONENTS

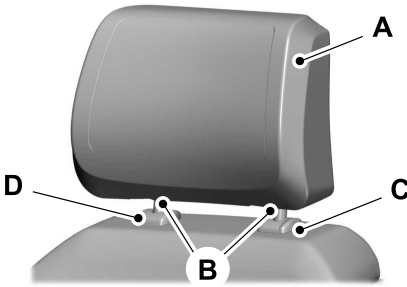

The head restraints consist of:

- A An energy absorbing head restraint.
- B Two steel stems.
- C Guide sleeve adjust and release button.
- D Guide sleeve unlock and remove button (If equipped).

ADJUSTING THE HEAD RESTRAINT

WARNING: Fully adjust the head restraint before you sit in or operate your vehicle. This will help minimize the risk of neck injury in the event of a crash. Do not adjust the head restraint when your vehicle is moving.

WARNING: The head restraint is a safety device. Whenever possible it should be installed and properly adjusted when the seat is occupied. Failure to adjust the head restraint properly could reduce its effectiveness during certain impacts.

WARNING: Adjust the head restraints for all passengers before you drive your vehicle. This will help minimize the risk of neck injury in the event of a crash. Do not adjust the head restraints when your vehicle is moving.

Note: Adjust the seat backrest to an upright driving position before adjusting the head restraint. Adjust the head restraint so that the top of it is level with the top of your head and as far forward as possible. Make sure that you remain comfortable. If you are extremely tall, adjust the head restraint to its highest position.

Pull the head restraint up to raise it.

To lower the head restraint:

1. Press and hold the adjust and release button.
2. Push the head restraint down.

Front Seats

REMOVING THE HEAD RESTRAINT

1. Pull up the head restraint until it reaches its highest position.
2. Press and hold the adjust and release button and the unlock and remove button.
3. Pull up the head restraint.

INSTALLING THE HEAD RESTRAINT

Align the steel stems into the guide sleeves and push the head restraint down until it locks.

MOVING THE SEAT BACKWARD AND FORWARD

WARNING: Make sure the seat fully locks into place by rocking it backward and forward. Not securing the seat into the locked position can be dangerous in a crash and could cause serious personal injury or death.



ADJUSTING THE SEAT BACKREST

WARNING: Always drive and ride with your seatback upright and the lap belt snug and low across the hips.

WARNING: Do not place cargo or any objects behind the seat backrest before returning it to the original position. Pull on the seat backrest to make sure that it has fully latched after returning the seat backrest to its original position. An unlatched seat may become dangerous if you stop suddenly or have a crash.



ADJUSTING THE LUMBAR SUPPORT

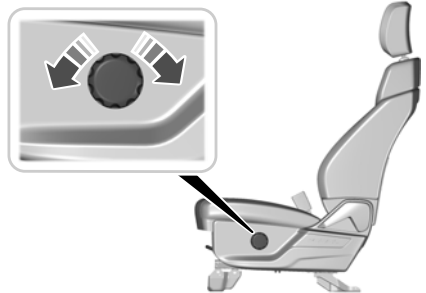

Front Seats

POWER SEATS (IF EQUIPPED)

HEADRESTRAINT COMPONENTS

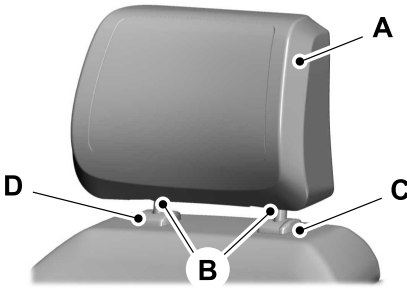

The head restraints consist of:

- A An energy absorbing head restraint.
- B Two steel stems.
- C Guide sleeve adjust and release button.
- D Guide sleeve unlock and remove button (If equipped).

ADJUSTING THE HEAD RESTRAINT

WARNING: Fully adjust the head restraint before you sit in or operate your vehicle. This will help minimize the risk of neck injury in the event of a crash. Do not adjust the head restraint when your vehicle is moving.

WARNING: The head restraint is a safety device. Whenever possible it should be installed and properly adjusted when the seat is occupied. Failure to adjust the head restraint properly could reduce its effectiveness during certain impacts.

WARNING: Adjust the head restraints for all passengers before you drive your vehicle. This will help minimize the risk of neck injury in the event of a crash. Do not adjust the head restraints when your vehicle is moving.

To raise the head restraint, pull the head restraint up.

To lower the head restraint:

1. Press and hold the adjust and release button.
2. Push the head restraint down.

To tilt the head restraint:



1. Adjust the seat backrest to an upright driving or riding position.
2. Pivot the head restraint forward toward your head to the preferred position.

After the head restraint reaches the forward-most tilt position, pivot it forward again to release it to the rearward, untilted position.

Front Seats

Note: Do not attempt to force the head restraint backward after it is tilted. Instead, continue tilting it forward until the head restraint releases to the upright position.

REMOVING THE HEAD RESTRAINT

1. Pull up the head restraint until it reaches its highest position.
2. Press and hold the adjust and release button and the unlock and remove button.
3. Pull up the head restraint.

Note: You cannot remove head restraints that have audio system speakers.

INSTALLING THE HEAD RESTRAINT

Align the steel stems into the guide sleeves and push the head restraint down until it locks.

MOVING THE SEAT BACKWARD AND FORWARD

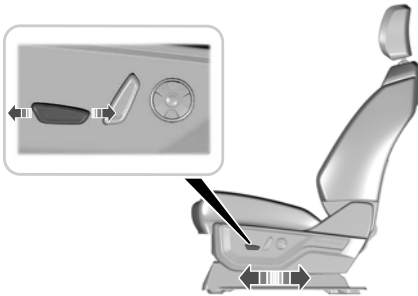

If the seat stops prior to reaching the end of the travel position, or an obstruction occurs, a new stopping position is learned.

To reset the stopping position:

1. Remove any obstruction.

2. Press and hold the control until the seat stops moving.
3. Press and hold the control again until the seat stops.
4. Continue holding the control for a few seconds. The new position is learned.

ADJUSTING THE SEAT CUSHION

(If Equipped)

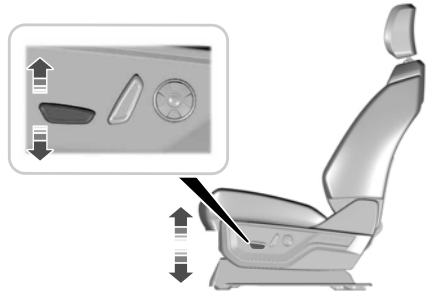

ADJUSTING THE SEAT BACKREST

WARNING: Always drive and ride with your seatback upright and the lap belt snug and low across the hips.



Front Seats

Adjusting the Seat Flat (If Equipped)

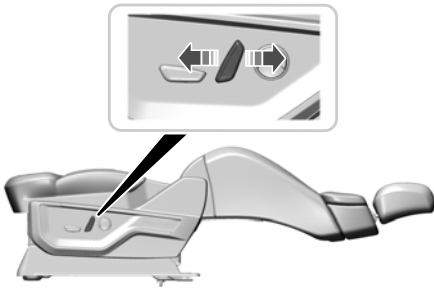

This feature allows the occupant to find a comfortable position to rest when the vehicle is not moving.

Note: Before adjusting the seat backrest fully flat, place the rear seat cushion into the upright position and remove any objects that could obstruct the movement of the flat seat. See **Folding the Seats** (page 199).

As the seat folds flat, the cushion adjusts to support the hips and lower back. For additional support, you can also adjust the upper seat backrest.

If you fully recline the passenger seat and the vehicle is moving, a message appears on the instrument cluster and a tone sounds. To switch the warning off, return the seat to an upright position.

Adjusting the Upper Seat Backrest (If Equipped)

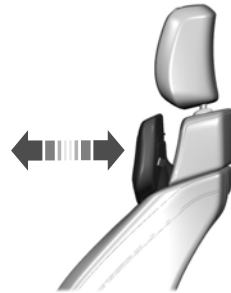

The front upper seat backrest tilts for extra comfort. To tilt the upper seat backrest, pivot the upper seat backrest toward your shoulders.

After the upper seat backrest reaches the forward-most tilt position, pivot it forward again to release it to the rearward, untilted position.

ADJUSTING THE SEAT HEIGHT

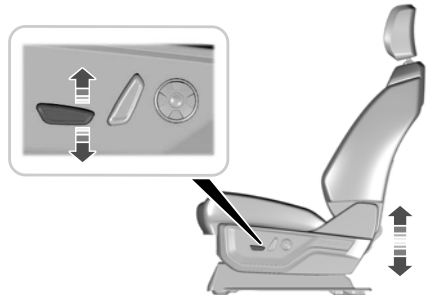

Front Seats

ADJUSTING THE LUMBAR SUPPORT

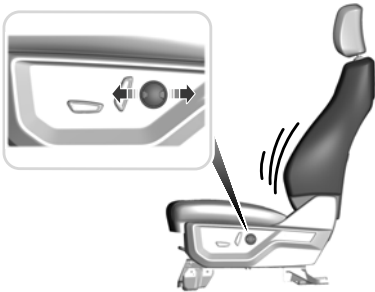

ADJUSTING THE MASSAGE SEAT SETTINGS

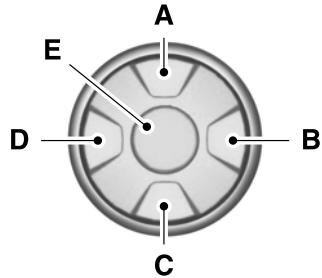

MASSAGE SEATS (IF EQUIPPED)

MASSAGE SEAT LIMITATIONS

The engine must be running or the vehicle must be in accessory mode to activate the seats.

The passenger side massage is available if the occupant meets the seat sensor weight requirements.

Allow a few seconds for any selection to activate. Selecting a different adjustment cancels the current one in progress. When the seat backrest and cushion are both active, the massage alternates between zones.

- A Select the previous massage pattern or lumbar area.
- B Decrease the massage or lumbar Intensity.
- C Select the next massage pattern or lumbar area.
- D Increase the massage or lumbar Intensity.
- E Select the massage or lumbar mode.

You can also adjust this feature through the touchscreen.

Front Seats

HEATED SEATS (IF EQUIPPED)

HEATED SEAT PRECAUTIONS



WARNING: Use caution when using the heated seat if you are unable to feel pain to your skin because of advanced age, chronic illness, diabetes, spinal cord injury, medication, alcohol use, exhaustion or other physical conditions. The heated seat could cause burns even at low temperatures, especially if used for long periods of time. Failure to follow this instruction could result in personal injury.



WARNING: Do not poke sharp objects into the seat cushion or seat backrest. This could damage the heated seat element and cause it to overheat. Failure to follow this instruction could result in personal injury.



WARNING: Do not place anything on the seat that blocks the heat, for example a seat cover or a cushion. This could cause the seat to overheat. Failure to follow this instruction could result in personal injury.

Do not:

- Place heavy objects on the seat.
- Operate the heated seat if water or any other liquid spills on the seat. Allow the seat to dry.

SWITCHING THE HEATED SEATS ON AND OFF

The vehicle must be running to use this feature.



Press the heated seat symbol on the climate controls or touchscreen to cycle through the various heat settings and off. The more indicators that display, the warmer the temperature of the seat.

Note: *The heated seats may remain on after you remote start your vehicle, based on your remote start settings. The heated seats may also turn on when you start your vehicle if they were on when you switched your vehicle off.*

VENTILATED SEATS (IF EQUIPPED)

VENTILATED SEAT PRECAUTIONS

Do not:

- Spill liquid on the front seats. This may cause the air vent holes to become blocked and not work properly.
- Place cargo or objects under the seats. They may block the air intake causing the air vents to not work properly.

SWITCHING THE VENTILATED SEATS ON AND OFF

The vehicle must be running to use this feature.



Front Seats

Press this symbol on the climate controls or the touchscreen to cycle through the various ventilation settings and off. More indicator lights indicate higher fan speeds.

Note: *When you switch the climate control fan speed and the ventilated seats to their maximum settings, the ventilated seats provide increased cooling.*

If the engine falls below 350 RPM while the ventilated seats are on, the feature turns itself off unless the vehicle is in Auto-Start-Stop mode. You may need to reactivate the ventilated seats.

Note: *The ventilated seats may remain on after you remote start your vehicle, based on your remote start settings. The ventilated seats may also turn on when you start your vehicle if they were on when you switched your vehicle off.*

Rear Seats (If Equipped)

MANUAL SEATS

HEADRESTRAINT COMPONENTS

Rear Seat Outermost Head Restraints

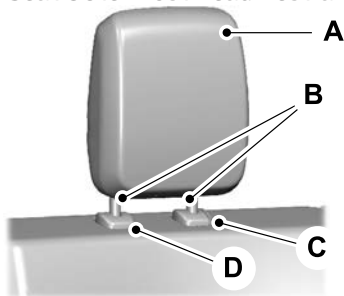

Rear Seat Center Head Restraint

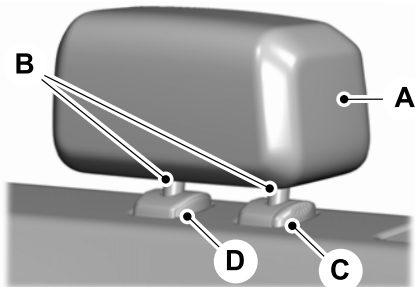

The head restraints consist of:

- A An energy absorbing head restraint.
- B Two steel stems.
- C Guide sleeve adjust and release button.
- D Guide sleeve unlock and remove button (If equipped).

ADJUSTING THE HEAD RESTRAINT

Pull the head restraint up to raise it.

To lower the head restraint:

1. Press and hold the adjust and release button.
2. Push the head restraint down.

REMOVING THE HEAD RESTRAINT

1. Pull up the head restraint until it reaches its highest position.
2. Press and hold the adjust and release button and the unlock and remove button.
3. Pull up the head restraint.

INSTALLING THE HEAD RESTRAINT

Align the steel stems into the guide sleeves and push the head restraint down until it locks.

FOLDING THE SEATS

You can flip each seat cushion up into a vertical storage position.



Rotate the seat up until it locks in place.

Rear Seats (If Equipped)

UNFOLDING THE SEATS

WARNING: Make sure that cargo and other objects are not trapped under the seat cushion and that you return the seat cushion to the full-down position. Failure to do so may prevent the seat from operating properly, which could increase the risk of serious injury in a crash.

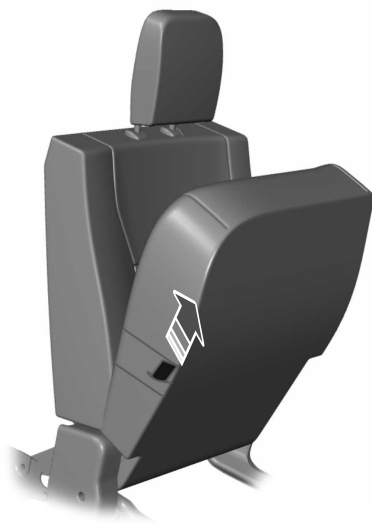

Pull the strap to lower the seat

HEATED SEATS (IF EQUIPPED)

HEATED SEAT PRECAUTIONS

WARNING: Use caution when using the heated seat if you are unable to feel pain to your skin because of advanced age, chronic illness, diabetes, spinal cord injury, medication, alcohol use, exhaustion or other physical conditions. The heated seat could cause burns even at low temperatures, especially if used for long periods of time. Failure to follow this instruction could result in personal injury.

WARNING: Do not poke sharp objects into the seat cushion or seat backrest. This could damage the heated seat element and cause it to overheat. Failure to follow this instruction could result in personal injury.

WARNING: Do not place anything on the seat that blocks the heat, for example a seat cover or a cushion. This could cause the seat to overheat. Failure to follow this instruction could result in personal injury.

Do not:

- Place heavy objects on the seat.
- Operate the heated seat if water or any other liquid spills on the seat. Allow the seat to dry.

SWITCHING THE HEATED SEATS ON AND OFF

The vehicle must be running to use this feature.

The rear seat heat controls are on the rear of the center console.

Rear Seats (If Equipped)



Press the heated seat symbol to cycle through the various heat settings and off. More indicator lights indicate warmer settings.

The heated seats turn off when you switch off the vehicle.

Rear Occupant Alert System (If Equipped)

WHAT IS THE REAR OCCUPANT ALERT SYSTEM

The rear occupant alert system monitors vehicle conditions and notifies you to check for rear seat occupants when you switch the ignition off.

HOW DOES THE REAR OCCUPANT ALERT SYSTEM WORK

The system monitors when rear doors have been opened and closed to indicate the potential presence of an occupant in the rear seat.

A message displays in the information and entertainment display screen and an audible warning sounds when you switch the ignition off after any of the following conditions have been met:

- A rear door is opened or closed while the ignition is on.
- You switch the ignition on within 15 minutes of a rear door opening and closing.
- You switch the ignition on within 15 minutes of the alert having displayed or sounded.

REAR OCCUPANT ALERT SYSTEM PRECAUTIONS



WARNING: On hot days, the temperature inside the vehicle can rise very quickly. Exposure of people or animals to these high temperatures for even a short time can cause death or serious heat related injuries, including brain damage. Small children are particularly at risk.



WARNING: Do not leave children or pets unattended in your vehicle. Failure to follow this instruction could result in personal injury or death.

REAR OCCUPANT ALERT SYSTEM LIMITATIONS

The system does not detect the presence of objects or passengers in the rear seat. It monitors when rear doors are opened and closed.

Note: *It is possible to receive an alert when there is no rear seat occupant, but alert conditions are met.*

Note: *It is possible to receive no alert when there is an occupant in the rear seat, if alert conditions are not met. For example, if a rear seat occupant does not enter the vehicle through a rear door.*

Note: *The audible warning does not sound when the front door is opened before you switch the ignition off.*

SWITCHING REAR OCCUPANT ALERT SYSTEM ON AND OFF

1. Press **Settings** on the touchscreen.
2. Press **Vehicle**.
3. Switch **Rear Occupant Alert** on or off.

Note: *The default setting is on.*

Note: *Performing a master reset causes the system to switch on again.*

Semiannual Reminder (If Equipped)

When you switch the system off, a message appears every six months as a reminder that the system is off. You can switch the system back on or leave it off.

Rear Occupant Alert System (If Equipped)

REAR OCCUPANT ALERT SYSTEM INDICATORS

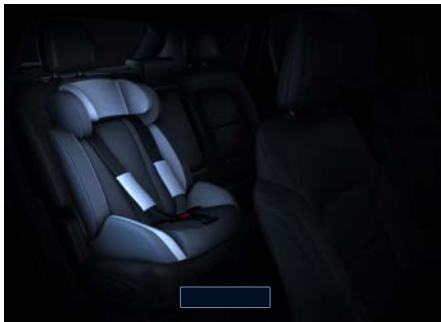

| Message |
|---------------------------------|
| Check rear seats for occupants. |

Displays when you switch your vehicle off after the alert conditions are met.

The message displays for a short period of time. Press **Close** to acknowledge and remove the message.

Note: Depending on your SYNC version, the graphic may look different from what you see here.

REAR OCCUPANT ALERT SYSTEM AUDIBLE WARNINGS

Sounds when you switch your vehicle off after the alert conditions are met.

The warning sounds for a short period of time.

Memory Function (If Equipped)

WHAT IS THE MEMORY FUNCTION

The memory function recalls the position of these features:

- Driver seat.
- Power mirrors.
- Optional power steering column.
- Optional power adjustable pedals.

MEMORY FUNCTION PRECAUTIONS



WARNING: Before activating the memory seat, make sure that the area immediately surrounding the seat is clear of obstructions and that all occupants are clear of moving parts.



WARNING: Do not use the memory function when your vehicle is moving.

LOCATING THE MEMORY FUNCTION BUTTONS



The memory function buttons are on the driver door.

SAVING A PRESET POSITION

1. Adjust the memory features to your preferred position.
2. Press and hold the preferred preset button until you hear a single tone.

A confirmation message appears in the information display.

You can save up to three preset memory positions at any time.

RECALLING A PRESET POSITION

Press and release a preset button.

Note: You can recall a preset memory position when the ignition is off, or when you place the transmission in park (P) or neutral (N) if the ignition is on and the vehicle is not moving.

Note: Pressing any of the preset buttons or any memory feature control during a memory recall cancels the operation.

You can also recall a preset memory position by:

- Pressing the unlock button on your remote control if you linked it to a preset position.
- Unlocking the intelligent driver door handle if a linked remote control is present.

Using a linked remote control to recall your memory position when the ignition is off moves the seat and steering column to the easy entry position.

Linking a Preset Position to Your Remote Control or Passive Key

See **Linking or Unlinking a Personal Profile to a Remote Control** (page 629).

Garage Door Opener (If Equipped)

WHAT IS THE GARAGE DOOR OPENER

HomeLink Wireless Control System



The universal garage door opener replaces the common hand-held garage door opener with a three-button transmitter integrated into the driver's sun visor.

HOW DOES THE GARAGE DOOR OPENER WORK

The system includes two primary features, a garage door opener and a platform for remote activation of devices within the home. You can program garage doors as well as entry gate operators, security systems, entry door locks and home or office lighting.

Additional system information can be found online at www.homelink.com or by calling the toll-free help line at 1-800-355-3515.

Note: You can program a maximum of three devices. To change or replace any of the three devices after it has been initially programmed, you must first erase the current settings. See **Clearing the Garage Door Opener** (page 207).

GARAGE DOOR OPENER PRECAUTIONS



WARNING: Do not use the system with any garage door opener that does not have the safety stop and reverse feature as required by U.S. Federal Safety Standards (this includes any garage door opener manufactured before April 1, 1982). A garage door opener which cannot detect an object, signaling the door to stop and reverse, does not meet current federal safety standards. Using a garage door opener without these features increases the risk of serious injury or death.

Note: Make sure that the garage door and security device are free from obstruction when you are programming. Do not program the system with your vehicle in the garage.

Note: Make sure you keep the original remote control transmitter for use in other vehicles as well as for future system programming.

Note: We recommend that upon the sale or lease termination of your vehicle, you erase the programmed function buttons for security reasons. See **Clearing the Garage Door Opener** (page 207).

GARAGE DOOR OPENER LIMITATIONS

Canadian radio-frequency laws require transmitter signals to time-out (or quit) after several seconds – which may not be long enough for HomeLink to pick up the signal.

U.S. gate operators time-out in the same manner.

Garage Door Opener (If Equipped)

Note: If programming a garage door opener or gate operator, it is advised to unplug the device during the “cycling” process to prevent possible overheating.

PROGRAMMING THE GARAGE DOOR OPENER TO YOUR HAND-HELD TRANSMITTER

This process is to program your in-vehicle HomeLink function button with your hand-held transmitter.

Note: The programming steps below assume you will be programming HomeLink that was not previously programmed. If your HomeLink was previously programmed, you may need to erase your HomeLink buttons. See **Clearing the Garage Door Opener** (page 207).

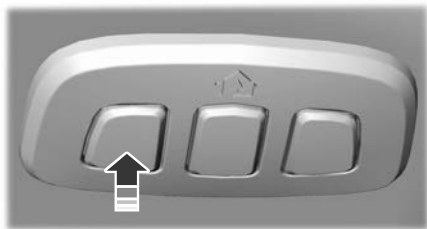

1. With your vehicle parked outside of the garage, switch your ignition to the on position, but do not start your vehicle.
2. Press and release one of the three HomeLink function buttons that you would like to program.
3. Hold your hand-held garage door transmitter 1–3 in (2–8 cm) away from the HomeLink button you want to program.

4. Press and hold the hand-held transmitter button you want to program while watching the indicator light on HomeLink. Continue to hold the hand-held button until the HomeLink indicator light flashes rapidly or is continuously on.

Note: You may need to use a different method if you live in Canada or have difficulties programming your gate operator or garage door opener. See **Programming the Garage Door Opener to Your Gate Opener Motor** (page 207).

5. Press and hold the HomeLink button you programmed for two seconds, then release. You may need to do this twice to activate the door.

Note: If the indicator light stays on, the programming is complete.

Note: If the HomeLink indicator flashes rapidly, repeat step 5.

Note: If your device still does not operate, you must program your garage door. See **Programming the Garage Door Opener to Your Garage Door Opener Motor** (page 206).

6. To program additional buttons, repeat Steps 1 – 4.

PROGRAMMING THE GARAGE DOOR OPENER TO YOUR GARAGE DOOR OPENER MOTOR



Garage Door Opener (If Equipped)

1. Press the learn button on the garage door opener motor, you have 30 seconds to complete the next two steps.
2. Return to your vehicle.

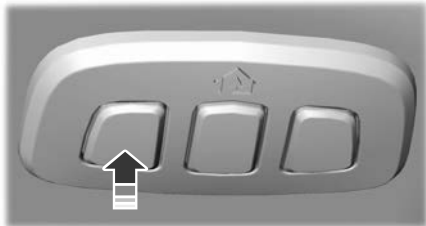

3. Press and hold one of the three HomeLink function buttons you want to program for two seconds, then release. Repeat this step. Depending on your brand of garage door opener, you may need to repeat this sequence a third time.

PROGRAMMING THE GARAGE DOOR OPENER TO YOUR GATE OPENER MOTOR

Gate Operator / Canadian Programming

Canadian radio-frequency laws require transmitter signals to “time-out” (or quit) after several seconds of transmission – which may not be long enough for HomeLink to pick up the signal during programming. Similar to this Canadian law, some U.S. gate operators “time-out” in the same manner.

Note: *If programming a garage door opener or gate operator, it is advised to unplug the device during the “cycling” process to prevent possible overheating.*

1. Press and release, every two seconds, your hand-held transmitter until the HomeLink indicator light changes to a rapidly blinking or continuously on light.
2. Release the hand-held transmitter button.
3. Press and hold the HomeLink function button you want to program for two seconds, then release. You may need to do this twice to activate the door.

Note: *If the indicator light stays on, the programming is complete.*

Note: *If the HomeLink indicator flashes rapidly, repeat Step 3.*

Note: *If your device still does not operate, you must program your garage door. See **Programming the Garage Door Opener to Your Garage Door Opener Motor** (page 206).*

4. To program additional buttons, repeat Steps 1 – 4.

CLEARING THE GARAGE DOOR OPENER

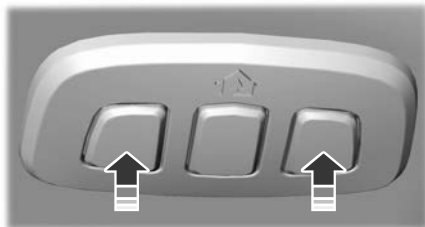

1. Press and hold the outer two function buttons simultaneously for approximately 10 seconds until the indicator light above the buttons flashes rapidly.

Garage Door Opener (If Equipped)

2. When the indicator light flashes, release the buttons.

Note: *You cannot erase individual buttons.*

REPROGRAMMING THE GARAGE DOOR OPENER

To program a device to a previously trained button, follow these steps:

1. Press and hold the desired button. Do NOT release the button.
2. The indicator light begins to flash after 20 seconds. Without releasing the button, follow programming steps.

GARAGE DOOR OPENER RADIO FREQUENCIES

FCC and RSS-210 Industry Canada Compliance



WARNING: Changes or modifications not expressly approved by the party responsible for compliance could void the user's authority to operate the equipment. The term "IC:" before the radio certification number only signifies that Industry Canada technical specifications were met.

This device complies with Part 15 of the FCC Rules and with RSS-210 of Industry Canada. Operation is subject to the following two conditions: (1) this device may not cause harmful interference, and (2) this device must accept any interference received, including interference that could cause undesired operation.

This equipment complies with FCC radiation exposure limits set forth for an uncontrolled environment. End Users must follow the specific operating instructions for satisfying RF exposure compliance. This transmitter must be at least 8 in (20 cm) from the user and must not be co-located or operating in conjunction with any other antenna or transmitter.

USB Ports

LOCATING THE USB PORTS

Data Transfer USB Ports



The USB ports could be in the following locations:

- On the lower instrument panel below the climate control.
- Inside the center console.

Note: *These USB ports can also charge devices.*

Note: *Not all USB ports in your vehicle have data transfer capabilities.*

Note: *We recommend using only USB-IF certified cables and adapters. Non-certified cables and adapters may not work.*

Charge Only USB Ports



The USB ports could be in the following locations:

- On the lower instrument panel.
- On the upper instrument panel.
- Inside the media bin.
- Inside the center console.
- On the rear of the center console.
- In the cargo area.

LOCATING THE USB PORTS - RAPTOR

Data Transfer USB Ports



The USB Ports could be in the following locations:

- Inside the media bin.
- Inside the center console.

Note: *These USB ports can also charge devices.*

Note: *Not all USB ports in your vehicle have data transfer capabilities.*

Note: *We recommend using only USB-IF certified cables and adapters. Non-certified cables and adapters may not work.*

Charge Only USB Ports



The USB ports could be in the following locations:

- On the lower instrument panel.
- On the upper instrument panel.
- Inside the media bin.
- Inside the center console.
- On the rear of the center console.
- In the cargo area.

PLAYING MEDIA USING THE USB PORT



WARNING: Driving while distracted can result in loss of vehicle control, crash and injury. We strongly recommend that you use extreme caution when using any device that may take your focus off the road. Your primary responsibility is the safe operation of your vehicle. We recommend against the use of any hand-held device while driving and encourage the use of voice-operated systems when possible. Make sure you are aware of all applicable local laws that may affect the use of electronic devices while driving.

USB Ports

Connect your device to the USB port.



Press the audio button on the feature bar.

Select **Sources**.



Select the USB option.



Press the button to play a track. Press the button again to pause the track.



Press the button to skip to the next track.

Press and hold the button to fast forward through the track.



Press the button once to return to the beginning of a track. Repeatedly press the button to return to previous tracks.

Press and hold the button to fast rewind.

CHARGING A DEVICE

Connect your device to the USB port.

Data Transfer USB Ports



You can charge your device through the data transfer USB port when SYNC is on.

Charge Only USB Ports



You can charge your device through the charge only USB port when the vehicle is in accessory mode or when the vehicle is running.

Power Outlet - Vehicles With: Pickup Bed Power Generator Outlet

WHAT IS THE POWER OUTLET

The vehicle functions as a portable generator and can power devices that require up to the rating listed on power outlet label.

POWER OUTLET PRECAUTIONS - VEHICLES WITH: 2KW



WARNING: Do not start the engine in a closed garage or in other enclosed areas. Exhaust fumes are toxic. Always open the garage door before you start the engine. Failure to follow this instruction could result in personal injury or death.



WARNING: Exhaust leaks may result in entry of harmful and potentially lethal fumes into the passenger compartment. If you smell exhaust fumes inside your vehicle, have your vehicle inspected immediately. Do not drive if you smell exhaust fumes.



WARNING: Do not connect any vehicle power outlets to any premises. This can create a backfeed to utility lines. Failure to follow this instruction could result in property damage, fire, electrical shock or death.



WARNING: The vehicle's engine runs while the generator is switched on. Running engines emit carbon monoxide. Only use the generator when the vehicle is outdoors. Failure to follow this instruction could result in personal injury or death.

Note: *Automatic engine stop is disabled and the gasoline engine will continue to idle when the outlet is switched on.*

Note: *We recommend using UL approved devices for use with the power outlet.*

Note: *Unplug electrical devices from the power outlet when they are not switched on.*

Note: *Make sure there is no damage to the outlets before driving your vehicle.*

Note: *Make sure that objects are not blocking the inverter inlet and exhaust near the rear underseat storage compartment.*

Note: *The climate control system may turn on and power may be limited during extreme hot or cold temperatures to optimize the performance of the system.*

Note: *When the outlet is switched on and the vehicle is in Park (P) the engine turns off 30 minutes after the low fuel warning is displayed. After the vehicle is turned off, generator mode only operates while driving or until the vehicle is refueled.*

Power Outlet - Vehicles With: Pickup Bed Power Generator Outlet

Grounding Types

| Vehicle Type | Grounding Type |
|--------------|---|
| Gas | Neutral floating: The neutral of the inverter generator is isolated from system ground. |
| HEV | Neutral bonded: The neutral of the inverter generator is bonded to system ground. Connecting loads that also have neutral bonded to ground will cause the ground fault detection to trip. |

Note: *If additional grounding measures are required, consult with a qualified electrician.*

POWER OUTLET PRECAUTIONS - VEHICLES WITH: 2.4KW/7.2KW



WARNING: Do not start the engine in a closed garage or in other enclosed areas. Exhaust fumes are toxic. Always open the garage door before you start the engine. Failure to follow this instruction could result in personal injury or death.



WARNING: Exhaust leaks may result in entry of harmful and potentially lethal fumes into the passenger compartment. If you smell exhaust fumes inside your vehicle, have your vehicle inspected immediately. Do not drive if you smell exhaust fumes.



WARNING: Do not connect any vehicle power outlets to any premises, including buildings or recreational vehicles. This can create a backfeed to utility lines. Failure to follow this instruction could result in damage to the vehicle, fire, electrical shock or death.



WARNING: The vehicle's engine runs while the generator is switched on. Running engines emit carbon monoxide. Only use the generator when the vehicle is outdoors. Failure to follow this instruction could result in personal injury or death.

Note: *The gasoline engine may start and stop to provide power when the outlet is switched on.*

Note: *We recommend using UL approved devices for use with the power outlet.*

Note: *Unplug electrical devices from the power outlet when they are not switched on.*

Note: *The climate control system may turn on and power may be limited during extreme hot or cold temperatures to optimize the performance of the system.*

Note: *When the outlet is switched on and the vehicle is in Park (P) the engine turns off 30 minutes after the low fuel warning is displayed. After the vehicle is turned off, generator mode only operates while driving or until the vehicle is refueled.*

Power Outlet - Vehicles With: Pickup Bed Power Generator Outlet

Grounding Types

| Vehicle Type | Grounding Type |
|--------------|---|
| Gas | Neutral floating: The neutral of the inverter generator is isolated from system ground. |
| HEV | Neutral bonded: The neutral of the inverter generator is bonded to system ground. Connecting loads that also have neutral bonded to ground will cause the ground fault detection to trip. |

Note: *If additional grounding measures are required, consult with a qualified electrician.*

LOCATING THE POWER OUTLETS

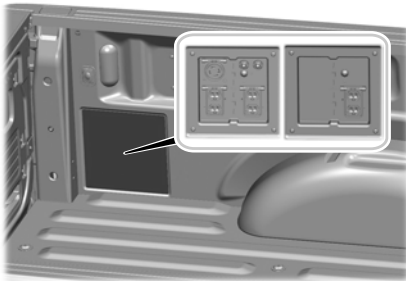

The power outlets are behind covers on the left side of the bed.

POWER OUTLET INDICATORS - VEHICLES WITH: 2KW

Power Outlet Status Indicator

The power outlet indicator illuminates to let you know the status of the system.

| Indicator Status | Description |
|------------------|---|
| On | The power point is working and the vehicle is on. |
| Off | The power point is off or the vehicle is off. |
| Flashing | The power point is in fault mode. |

Generator Mode Power Indicator



Power Outlet - Vehicles With: Pickup Bed Power Generator Outlet

The generator mode power indicator displays the currently used power and total available power level on the touchscreen. When Generator Mode is switched off the indicator displays a reduced available power level. When generator mode is switched on the indicator displays the full available power.

Note: *Ensure plugged in devices do not exceed the available power displayed on the generator mode power indicator.*

Note: *Maximum power may be reduced when the vehicle is in drive (D).*

POWER OUTLET INDICATORS - VEHICLES WITH: 2.4KW/ 7.2KW

Power Outlet Status Indicator

The power outlet indicator illuminates to let you know the status of the system.

| Indicator Status | Description |
|------------------|---|
| On | The power point is working and the vehicle is on. |
| Off | The power point is off and the vehicle is off. |
| Flashing | The power point is in fault mode. |

Generator Mode Power Indicator



The generator mode power indicator displays the currently used power and total available power level on the touchscreen. When Generator Mode is switched off the indicator displays a reduced available power level. When generator mode is switched on the indicator displays the full available power.

Note: *Additional indicators may be available based on vehicle configuration.*

Note: *Ensure plugged in devices do not exceed the available power displayed on the generator mode power indicator.*

WHAT IS UTILITY IDLE MODE - VEHICLES WITH: FLIP KEY

Utility Idle mode allows you to remove the key from the ignition and keep the vehicle and bed power point running.

SWITCHING UTILITY IDLE ON AND OFF - VEHICLES WITH: FLIP KEY

Switching Utility Idle On

1. Start the vehicle. See **Starting and Stopping the Engine** (page 231).

Power Outlet - Vehicles With: Pickup Bed Power Generator Outlet

2. Press the Features button on the touchscreen.
3. Press the Pro Power Onboard button.
4. Press the Generator Mode button to switch the power outlet to the rating listed on the power outlet label.
5. Press the Utility Idle button.
6. Turn the key to position **O**.
7. Remove the key from the ignition.

Switching Utility Idle Off using the Key

1. Insert the key into the ignition.
2. Turn the key to position **III**.

Switching Utility Idle off using the Information and Entertainment Display Screen

Use the controls on the touchscreen to switch off the vehicle.

WHAT IS GENERATOR MODE

Generator Mode uses the vehicle engine to increase power to the bed power outlets up to the rating listed on the power outlet label.

SWITCHING GENERATOR MODE ON AND OFF

Using the Information and Entertainment Display Screen

1. Switch the vehicle on. See **Starting and Stopping the Engine** (page 231).
2. Press the Features button on the touchscreen.
3. Press the Pro Power Onboard button.
4. Press the Generator Mode button to switch the power outlet to the full rating listed on the power outlet label.

Using the Instrument Panel



Press the button to switch between off, Convenience Mode, and Generator Mode.

Using the Bed Control



Press the button to switch Generator Mode on and off.

RESETTING GROUND FAULT DETECTION

After disconnecting all electrical loads the ground fault can be reset using the switches on the power point, on the instrument panel or on the touchscreen.

Use the controls on the touchscreen to test the ground fault detection circuit.

Power Outlet - Vehicles With: Pickup Bed Power Generator Outlet

RESETTING THE CIRCUIT BREAKER - VEHICLES WITH: 7.2KW

Press the button on the upper right area of the bed outlet when the circuit breaker has opened after a fault has occurred to reset the circuit breaker to the on position. There are two circuit breaker buttons that correspond to the A and B outlets.



Power Outlet - Vehicles With: Pickup Bed Power Generator Outlet

POWER OUTLET – TROUBLESHOOTING

POWER OUTLET – INFORMATION MESSAGES

| Message | Description |
|--|---|
| Item(s) plugged in exceed the system's maximum capacity. Try unplugging one or more items and reset. See Owner's Manual for detail. | Ensure plugged in devices do not exceed the available power displayed. Devices may exceed the power rating shown the device label when plugged in. Unplug the device and switch the ignition on and off to reset the system. |
| Ground Fault Detected. See Owner's Manual for details. | After disconnecting all electrical loads, the ground fault can be reset using the switches on the power point, on the instrument panel or on the touchscreen. Use the controls on the touchscreen to test the ground fault detection circuit. |
| Generator System is outside its operating temperature and capacity is reduced. See Owner's Manual for details. | The climate control system may turn on and power may be limited during extreme hot or cold temperatures to optimize the performance of the system. |
| Another power source is trying to supply power to your vehicle's AC outlets. Disconnect vehicle from that power source. See Owner's Manual for details. | Do not plug in any device that supplies power to the vehicle through the power points. This could result in damage to vehicle systems. |
| Pro Power OnBoard is currently unavailable. See Owner's Manual for details. | The Pickup Bed Power Generator is in fault mode. Ensure all devices are unplugged from the system. Use the controls on the touchscreen to reset the system. Switch the vehicle on and off if the touchscreen controls are unable to reset the system. See an authorized dealer if these steps do not fix the fault. |
| This button test outlets for proper operation of ground fault detection. In a successful test, Pro Power OnBoard detects the ground fault and turns off. See Owner's Manual for details. | After disconnecting all electrical loads, the ground fault can be reset using the switches on the power point, on the instrument panel or on the touchscreen. Use the controls on the touchscreen to test the ground fault detection circuit. |

Power Outlet - Vehicles With: Pickup Bed Power Generator Outlet

| Message | Description |
|---|---|
| Extended idling in drive (D) is reducing available power to 4300W. See Owner's Manual for details | Extended idling in drive (D) is reducing available power. When safe, shift to park (P) while idling, or reduce power draw to less than 4300W to keep the generator running. |

Power Outlet - Vehicles With: Pickup Bed Power Generator Outlet

POWER OUTLET – FREQUENTLY ASKED QUESTIONS

Why is there a warning about something being plugged into the bed power outlet when I do not have anything plugged in?

One or more of the bed power outlet covers may be ajar or broken. Make sure the generator is off and check the outlet covers. Select OK on the instrument cluster display to acknowledge the warning.

Why can I not shift my vehicle out of Park (P)?

Make sure the bed power outlet covers are closed and not damaged. Press OK on the instrument cluster display to acknowledge the warning to be able to move the transmission from Park (P).

What do I do when my instrument cluster display is malfunctioning and I cannot acknowledge the warning to put the transmission in Drive (D).

Switch the vehicle off and make sure nothing is plugged into the bed power outlet and all outlet covers are closed. Switch the vehicle on and select OK on the instrument cluster display to acknowledge the warning. Have your vehicle serviced soon.

Power Outlet - Vehicles With: 120V Power Outlet

WHAT IS THE POWER OUTLET

The power outlet can power devices that require up to the rating on the outlet cover.

Note: The total power delivered is divided if more than one outlet is used.

POWER OUTLET PRECAUTIONS



WARNING: Do not use an extension cord or connect multiple devices to the power outlet. Doing so could result in overloading the power outlet. Failure to follow this instruction could result in fire, personal injury or property damage.



WARNING: Do not keep electrical devices plugged into the power outlet whenever the device is not in use. The outlet provides power when the vehicle is on. Failure to follow this instruction could result in personal injury.

POWER OUTLET LIMITATIONS

You should not use the power outlet for these types of electric devices:

- Cathode ray tube type televisions.
- Motor loads, such as vacuum cleaners, electric saws or other electric power tools and compressor-driven refrigerators.
- Measuring devices which process precise data, such as medical equipment or measuring equipment.
- Other appliances requiring an extremely stable power supply, such as microcomputer-controlled electric blankets or touch sensor lamps.

Note: Some devices may exceed the power rating on the device label when they are initially plugged-in and may require you to press the device power button more than one time in order to allow a soft start. After multiple attempts, if the device remains off, please consider that your device may require more than the available power.

Note: The power outlet provides full available power when the vehicle is in park (P). Power availability may be reduced when the vehicle is in drive (D). If more than one outlet is available in the vehicle, power is divided between the outlets that are in use at the same time.

LOCATING THE POWER OUTLETS

The power outlet may be located on the instrument panel, the rear of the center console or the in the bed.

Instrument Panel



Power Outlet - Vehicles With: 120V Power Outlet

Rear of the Center Console



| Indicator Status | Description |
|------------------|--|
| On | When the indicator light is on, the outlet is providing power. |
| Off | When the indicator light is off, there is no power to the outlet. |
| Flashing | When the indicator light is flashing, the outlet is in a fault mode. |

Bed



Fault mode

The power outlet temporarily turns off power if the device exceeds the watt limit.

1. Unplug your device.
2. Switch your vehicle off to let the system cool and reset the fault mode.
3. Switch your vehicle back on, but do not plug your device back in.
4. With your vehicle on, make sure the indicator light remains on.
5. Make sure your device does not exceed the power limits and then plug in your device.

Note: *If a fault occurs again, your device may exceed the capacity available from the power outlet.*

POWER OUTLET INDICATORS

The power outlet indicator illuminates to let you know the status of the system.

Power Outlet - Vehicles With: 12V Power Outlet

WHAT IS THE POWER OUTLET

The power outlet can power devices using a 12 V outlet adapter.

POWER OUTLET PRECAUTIONS



WARNING: Do not plug optional electrical accessories into the cigar lighter socket. Incorrect use of the cigar lighter can cause damage not covered by the vehicle warranty, and can result in fire or serious injury.

When you switch the vehicle on, you can use the socket to power 12 V appliances with a maximum current rating of 20 A. Do not use the power point over the vehicle capacity of 12 V DC 240 W or a fuse could blow. Do not plug in any device that supplies power to the vehicle through the power points. This could result in damage to vehicle systems. Do not hang any accessory from the accessory plug. Always keep the power point caps closed when not in use. Do not insert objects other than an accessory plug into the power point.

To prevent the battery from running out of charge:

- Do not use the power point longer than necessary when the vehicle is off.
- Do not leave devices plugged in overnight or when you park your vehicle for extended periods.

LOCATING THE POWER OUTLETS

Power outlets are in the following locations:

- On the instrument panel.
- Inside the center console.
- On the rear of the center console.

Center Console Work Surface

USING THE CENTER CONSOLE WORK SURFACE - VEHICLES WITH: COLUMN SHIFT

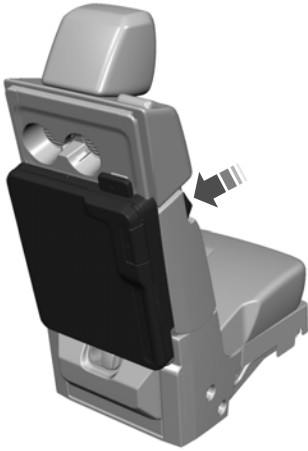

Push the latch down on the top of the work surface to move it to the forward position. There are 11 lockable positions.

Push the lever on the side of the seat and fold the seat down.

There are three different positions:

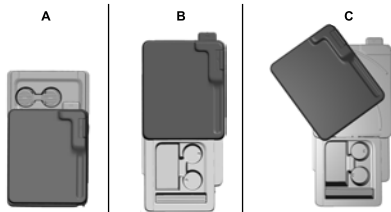

- A. Home position.
- B. Forward position.
- C. Rotated position.

Center Console Work Surface

Floor Console (if Equipped)

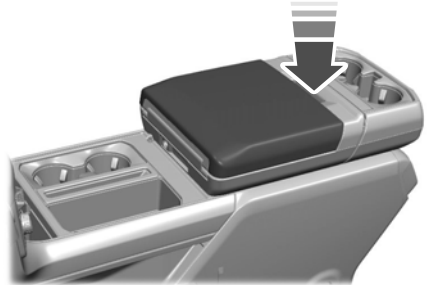
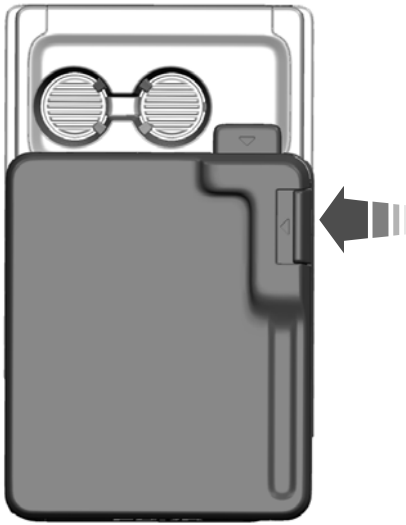

1. Press the button to release the folding surface.

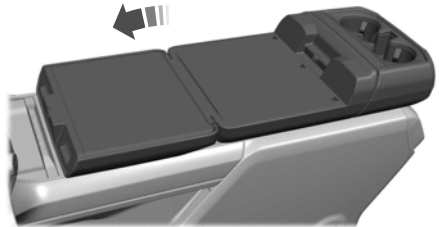

2. Open the work surface. Fold the work surface to close.

Push the latch on the side of the work surface to rotate it toward the driver. It rotates into 11 lockable positions in 5° increments.

Note: The work surface must be in the home position when driving your vehicle.

Note: Do not drive with the work surface rotated. This could interfere with steering your vehicle.

Note: Do not adjust the steering column with a rotated work surface.

Note: Do not raise the seat when the work surface is in the forward or rotated positions to avoid damaging it.

Note: To avoid damaging the work surface, do not use it as a handle when entering or exiting the vehicle.

USING THE CENTER CONSOLE WORK SURFACE - VEHICLES WITH: CONSOLE SHIFT

To use the center console work surface, stow the selector lever. See **Stowing the Selector Lever** (page 266).

Center Console Work Surface

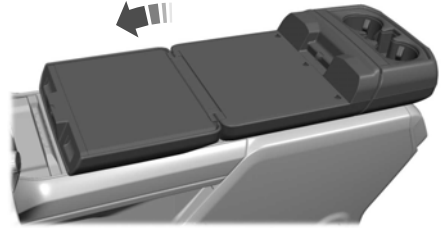
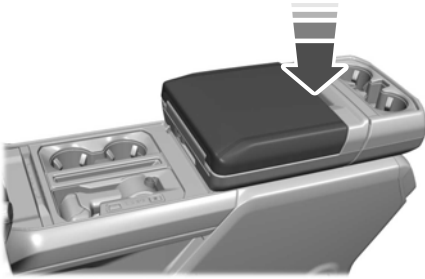

1. Press the button to release the folding surface.
2. Open the work surface. Fold the work surface to close.

CENTER CONSOLE WORK SURFACE – TROUBLESHOOTING

CENTER CONSOLE WORK SURFACE – INFORMATION MESSAGES

| Message | Action |
|-----------------------------------|--|
| Stow work surface before driving. | Return the work surface to the home position to clear the message. |

Wireless Accessory Charger (If Equipped)

WHAT IS THE WIRELESS ACCESSORY CHARGER

The wireless accessory charger allows you to charge one compatible Qi wireless charging device on the charging area.

WIRELESS ACCESSORY CHARGER PRECAUTIONS



WARNING: Wireless charging devices can affect the operation of implanted medical devices, including cardiac pacemakers. If you have any implanted medical devices, we recommend that you consult with your physician.

Keep the charging area clean and remove foreign objects prior to charging a device.

Do not place items with a magnetic strip or radio-frequency identification chip, for example passports, parking tickets, transportation passes or credit cards, near the charging area when charging a device. Damage could occur to the magnetic strip or radio-frequency identification chip.

Do not place metal objects, for example remote controls, coins and candy wrappers, on or near the charging area when charging a device. Metal objects may heat up and degrade the charging performance, in addition to causing interruptions in charging.

Charging could be interrupted, degraded, or could stop if any of the following occur:

- The system detects a foreign object.
- The device is misaligned on the charging area.
- The device moves on the active charging area when the vehicle is in motion.

- The vehicle ambient temperature is too high.
- You attempt to charge a non-Qi compatible device on the wireless charger.

Note: *During charging, the device and the charger could heat up, this is normal. If the battery gets hotter than usual, the device may stop charging.*

LOCATING THE WIRELESS ACCESSORY CHARGER



The charging area is on the center console or in the media bin below the instrument panel.

CHARGING A WIRELESS DEVICE

Place the device on the center of the charging surface with the charging side down. The charging stops after your device reaches a full charge.

You can use the charger when the vehicle is in accessory mode, when the vehicle is running, or when SYNC is on.



Displays on the status bar when wireless charging is in progress.

Note: *The charging performance may be affected if your device is in a case. It may be necessary to remove the case to wirelessly charge your device.*

Note: *Software and firmware updates may affect device compatibility, including the use of unofficial software or firmware. You should verify charging functionality with your specific devices in-vehicle.*

Storage

CUP HOLDERS

CUP HOLDER PRECAUTIONS



WARNING: Use caution when stowing items or hot drinks in the cup holders. Items could become loose or spill during hard braking, acceleration or crashes. Failure to follow this instruction could result in personal injury.

GLOVE COMPARTMENT

OPENING THE GLOVE COMPARTMENT

Upper Glove Compartment

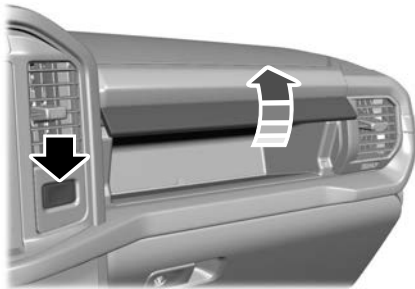

Push the button on the instrument panel to open.

Lower Glove Compartment



Pull the latch to the left to open.

LOCKING THE GLOVE COMPARTMENT

You can lock lower glove compartment using the key.

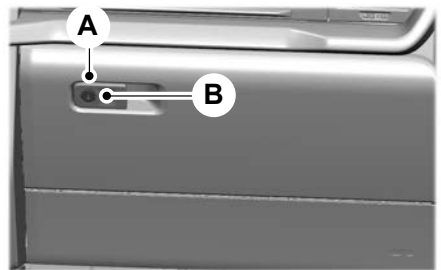

- A Unlock.
- B Lock.

Storage

UNDER SEAT STORAGE

LOCATING THE UNDER SEAT STORAGE COMPARTMENT

Front Under Seat Storage

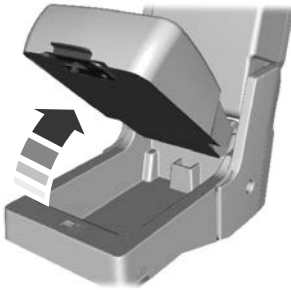

Lift the latch to access the storage compartment under the center seat cushion.

Locking the Front Under Seat Storage

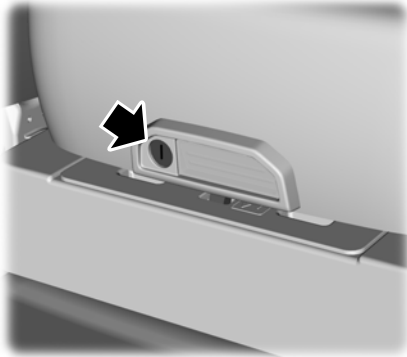

1. Use the key in the remote control to unlock.

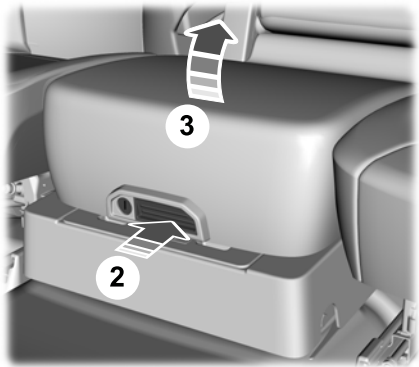

2. Press the latch to release the cushion.
3. Lift the cushion to access the storage compartment.

Rear Under Seat Storage



Lift the rear seat to access the under seat storage bin.

Storage

Locking the Rear Under Seat Storage



1. Lift the rear seat to access under seat storage bin.

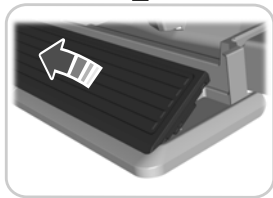
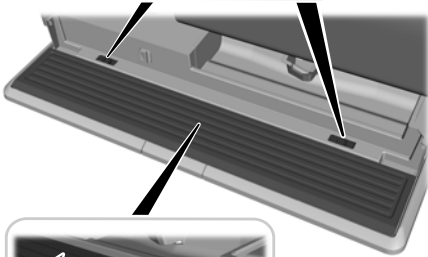
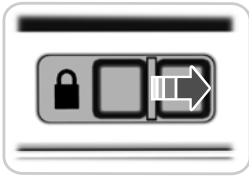

2. Lift the front and side panels to expand and lock them in place.

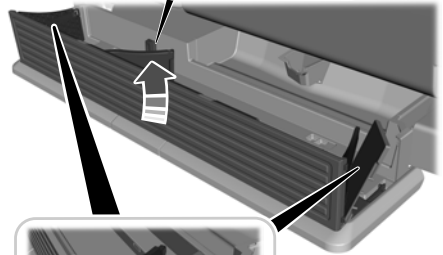
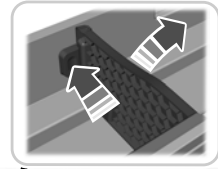

3. Lock the panels in an open position.

Storage

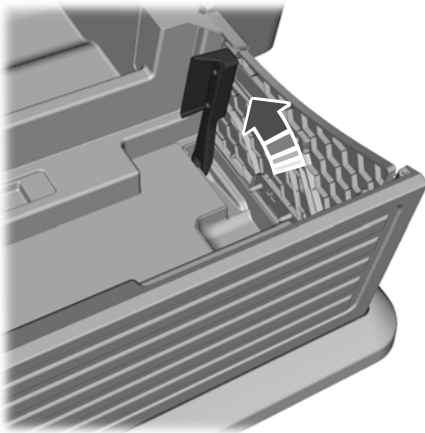

4. To collapse, release the lever, push down to the stowed position and fold in the side and front panels.

Note: Make sure the storage divider is not locked into place when collapsing. Push the button to release the divider door and swing to stowed position on front wall.

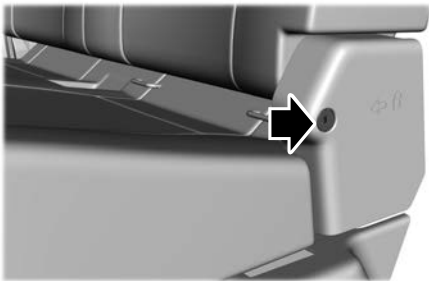

The locking key is in the key fob. Turn the key to lock or unlock the cushion.

GLASSES HOLDER

LOCATING THE GLASSES HOLDER

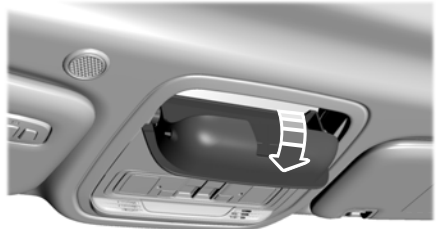

The glasses holder is in the overhead console.

Press near the rear edge of the door to open it.

Starting and Stopping the Engine

STARTING AND STOPPING THE ENGINE – PRECAUTIONS

WARNING: Extended idling at high engine speeds can produce very high temperatures in the engine and exhaust system, creating the risk of fire or other damage.

WARNING: Do not park, idle or drive your vehicle on dry grass or other dry ground cover. The emission system heats up the engine compartment and exhaust system, creating the risk of fire.

WARNING: Do not start the engine in a closed garage or in other enclosed areas. Exhaust fumes are toxic. Always open the garage door before you start the engine. Failure to follow this instruction could result in personal injury or death.

WARNING: Do not use starting fluid, for example ether, in the air intake system. Such fluid could cause immediate explosive damage to the engine and possible personal injury.

WARNING: Exhaust leaks may result in entry of harmful and potentially lethal fumes into the passenger compartment. If you smell exhaust fumes inside your vehicle, have your vehicle inspected immediately. Do not drive if you smell exhaust fumes.

The powertrain control system meets all Canadian interference-causing equipment standard requirements regulating the impulse electrical field or radio noise.

If you stop your vehicle and leave the engine idling for long periods, we recommend that you do one of the following:

- Open the windows at least 1 in (2.5 cm).
- Set your climate control to outside air.

IGNITION SWITCH (IF EQUIPPED)

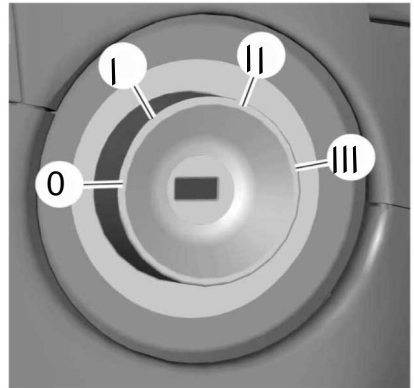

Switching the Ignition Off

Turn the key to position **0**.

Switching the Ignition to Accessory Mode

Turn the key to position **I**. Electrical accessories, for example the radio, operate without the engine running.

Switching the Ignition On

Turn the key to position **II**. All electrical circuits and accessories are operational and the warning lamps and indicators illuminate.

Starting and Stopping the Engine

Starting the Engine

Turn the key to position **III**. Release the key when the engine starts.

PUSH BUTTON IGNITION SWITCH (IF EQUIPPED)



Switching the Ignition Off

When the ignition is on or in accessory mode, press the push button ignition switch once without your foot on the brake pedal.

Switching the Ignition to Accessory Mode

When the ignition is off, press the push button ignition switch once without your foot on the brake pedal.

All electrical circuits and accessories are operational and the warning lamps and indicators illuminate.

Note: *Your vehicle has a battery saver feature that shuts your vehicle off when it detects a certain amount of battery drain, or after approximately 30 minutes of inactivity in accessory mode.*

Starting the Engine

With the transmission in park (P), press the brake pedal and press the push button ignition switch. An indicator light on the button illuminates when the ignition is on and when the engine starts.

Note: *The system may not function if the passive key is close to metal objects or electronic devices, for example keys or a cell phone.*

Note: *A valid key must be inside your vehicle to switch the ignition on and start the engine.*

STARTING THE ENGINE

STARTING A GASOLINE ENGINE - VEHICLES WITHOUT: PUSH BUTTON START

Before starting your vehicle, check the following:

- Make sure that the headlamps and electrical accessories are off.
 - Make sure that the parking brake is on.
 - Make sure that the transmission is in park (P).
1. Fully press the brake pedal.

Note: *Do not touch the accelerator pedal.*



2. Turn the key to position **III**.

Note: *The engine may continue cranking for up to 15 seconds or until it starts.*

Note: *The engine takes longer to start at lower temperatures. It may crank for several seconds when very cold.*

Starting and Stopping the Engine

STARTING A GASOLINE ENGINE - VEHICLES WITH: PUSH BUTTON START

Before starting your vehicle, check the following:

- Make sure that the headlamps and electrical accessories are off.
- Make sure that the parking brake is on.
- Make sure that the transmission is in park (P).

1. Fully press the brake pedal.

Note: Do not touch the accelerator pedal.



2. Press the push button ignition switch.

Note: The engine may continue cranking for up to 15 seconds or until it starts.

Note: The engine takes longer to start at lower temperatures. It may crank for several seconds when very cold.

STARTING A HYBRID ELECTRIC VEHICLE SYSTEM - VEHICLES WITHOUT: PUSH BUTTON START

Before starting your vehicle, check the following:

- Make sure that the headlamps and electrical accessories are off.
- Make sure that the parking brake is on.
- Make sure that the transmission is in park (P).

1. Fully press the brake pedal.

Note: Do not touch the accelerator pedal.



2. Turn the key to position III.

Note: The green ready indicator illuminates letting you know that your vehicle is ready for driving. Since your vehicle is equipped with a silent key start, the engine may not start when your vehicle starts.

When the engine starts for the first time on your drive, the idle speed increases, this helps to warm up the engine. If the engine idle speed does not slow down, have your vehicle checked by an authorized dealer.

STARTING A HYBRID ELECTRIC VEHICLE SYSTEM - VEHICLES WITH: PUSH BUTTON START

Before starting your vehicle, check the following:

- Make sure the headlamps and electrical accessories are off.
- Make sure the parking brake is on.
- Make sure the transmission is in park (P).

Note: Do not touch the accelerator pedal.

1. Fully press the brake pedal.



2. Press the push button ignition switch.

Note: The green ready indicator illuminates letting you know that your vehicle is ready for driving. Since your vehicle is equipped with a silent key start, the engine may not start when your vehicle starts.

Starting and Stopping the Engine

When the engine starts for the first time on your drive, the idle speed increases, this helps to warm up the engine. If the engine idle speed does not slow down, have your vehicle checked by an authorized dealer.

The system does not function if:

- The passive key frequencies are jammed.
- The key battery has no charge.

RESTARTING THE ENGINE AFTER STOPPING IT - VEHICLES WITH: PUSH BUTTON START

The system allows you to start the engine within 10 seconds of switching it off, even if it does not detect a valid passive key.

Within 10 seconds of switching the engine off, fully press the brake pedal and press the push button ignition switch. After 10 seconds, you can no longer start the engine if the system does not detect a valid passive key.

When you start the engine, it remains running until you press the push button ignition switch, even if your vehicle does not detect a valid passive key. If you open and close a door when the engine is running, the system searches for a valid passive key.

ENGINE BLOCK HEATER (IF EQUIPPED)

ENGINE BLOCK HEATER PRECAUTIONS



WARNING: Failure to follow engine block heater instructions could result in property damage or serious personal injury.



WARNING: Do not use your heater with ungrounded electrical systems or two-pronged adapters. There is a risk of electrical shock.



WARNING: Do not fully close the hood, or allow it to drop under its own weight when using the engine block heater. This could damage the power cable and may cause an electrical short resulting in fire, injury and property damage.

We recommend that you do the following for a safe and correct operation:

- Use a 16-gauge outdoor extension cord that is product certified by Underwriter's Laboratory (UL) or Canadian Standards Association (CSA). This extension cord must be suitable for use outdoors, in cold temperatures, and be clearly marked Suitable for Use with Outdoor Appliances. Do not use an indoor extension cord outdoors. This could result in an electric shock or become a fire hazard.
- Use as short an extension cord as possible.
- Do not use multiple extension cords.
- Make sure that when in operation, the extension cord plug and engine block heater cord plug connections are free and clear of water. This could cause an electric shock or fire.
- If the engine block heater cord is under the hood, do not remove the wiring from its original location. Do not close the hood on the extension wiring.
- Park your vehicle in a clean area, clear of combustible materials.
- Firmly connect the engine block heater cord and the extension cord.

Starting and Stopping the Engine

- Check the extension cord for heat anywhere when the system has been operating for approximately 30 minutes.
- Unplug and properly stow the system before starting and driving your vehicle. The protective cover seals the terminals of the engine block heater cord plug when not in use.
- Check the engine block heater system for proper operation before winter.

HOW DOES THE ENGINE BLOCK HEATER WORK

The engine block heater warms the engine coolant. This allows the climate control system to quickly respond. The equipment includes a heater element installed in the engine block and a wire harness. You can connect the system to a grounded 220-240 volt AC electrical source.

Note: *The engine block heater is most effective when outdoor temperatures are below 0°F (-18°C).*

USING THE ENGINE BLOCK HEATER

Make sure the receptacle terminals are clean and dry prior to use. Clean them with a dry cloth if necessary.

The heater uses 0.4 to 1.0 kilowatt-hours of energy per hour of use. The system does not have a thermostat. It achieves maximum temperature after approximately three hours of operation. Using the engine block heater longer than three hours does not improve system performance and unnecessarily uses electricity.

STOPPING THE ENGINE

STOPPING THE ENGINE WHEN YOUR VEHICLE IS STATIONARY - VEHICLES WITHOUT: PUSH BUTTON START

1. Shift into park (P).
2. Apply the parking brake.
3. Wait until the engine reaches idle speed.

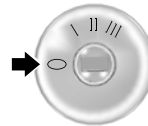

4. Turn the key to position **0**.

STOPPING THE ENGINE WHEN YOUR VEHICLE IS STATIONARY - VEHICLES WITH: PUSH BUTTON START

1. Shift into park (P).
2. Apply the parking brake.
3. Wait until the engine reaches idle speed.



4. Press the push button ignition switch.

Starting and Stopping the Engine

STOPPING THE ENGINE WHEN YOUR VEHICLE IS MOVING - VEHICLES WITHOUT: PUSH BUTTON START



WARNING: Switching off the engine when your vehicle is still moving results in a significant decrease in braking assistance. Higher effort is required to apply the brakes and to stop your vehicle. A significant decrease in steering assistance could also occur. The steering does not lock, but higher effort could be required to steer your vehicle. When you switch the ignition off, some electrical circuits, for example airbags, also turn off. If you unintentionally switch the ignition off, shift into neutral (N) and restart the engine.

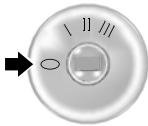

1. Turn the key to position **0**.
2. Shift into neutral and use the brakes to bring your vehicle to a safe stop.
3. Shift into park (P).
4. Apply the parking brake.

STOPPING THE ENGINE WHEN YOUR VEHICLE IS MOVING - VEHICLES WITH: PUSH BUTTON START



WARNING: Switching off the engine when your vehicle is still moving results in a significant decrease in braking assistance. Higher effort is required to apply the brakes and to stop your vehicle. A significant decrease in

steering assistance could also occur. The steering does not lock, but higher effort could be required to steer your vehicle. When you switch the ignition off, some electrical circuits, for example airbags, also turn off. If you unintentionally switch the ignition off, shift into neutral (N) and restart the engine.



1. Press and hold the push button ignition switch until the engine stops, or press it three times within two seconds.
2. Shift into neutral and use the brakes to bring your vehicle to a safe stop.
3. Shift into park (P).
4. Apply the parking brake.

AUTOMATIC ENGINE STOP - VEHICLES WITH: KEYLESS ENTRY AND PUSH BUTTON START

WHAT IS AUTOMATIC ENGINE STOP

Automatic engine stop is a feature that switches the engine off if it has been idling for an extended period to help you save fuel.

Starting and Stopping the Engine

HOW DOES AUTOMATIC ENGINE STOP WORK

Automatic engine stop turns the engine off. The ignition also turns off in order to save battery power. Before the engine shuts down, a message appears in the information display showing a timer counting down. If you do not intervene within 30 seconds, the engine shuts down. Another message appears in the information display to inform you that the engine has shut down in order to save fuel. Start your vehicle as you normally do.

SWITCHING AUTOMATIC ENGINE STOP ON AND OFF

1. Press **Settings** on the touchscreen.
2. Press **Vehicle Settings**.
3. Switch **30min Max Idle** on or off.

Note: You cannot permanently switch off the automatic shutdown. If you switch it off, it turns on each time you switch the ignition on.

OVERRIDING AUTOMATIC ENGINE STOP

You can stop the engine shutdown, or reset the timer, at any point before the 30-second countdown has expired by doing any of the following:

- Pressing the brake pedal or accelerator pedal.
- Pressing the **OK** or **RESET** button during the countdown.

Note: You cannot permanently switch off the automatic engine shutdown feature. When you switch it off temporarily, it turns on at the next ignition cycle.

ACCESSING THE PASSIVE KEY BACKUP POSITION

If you are unable to start your vehicle, locate the backup slot in one of two positions:

Type One

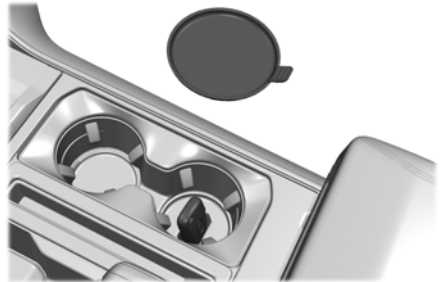

Type Two



Note: If your vehicle is equipped with Type One, make sure to place the key properly into the backup slot.

Note: If your vehicle is equipped with Type Two, make sure the buttons are facing the rear of the vehicle and the key ring up. Place the key into the backup slot.

With the key in the backup slot, press the brake pedal, then press the push button ignition switch to start your vehicle.

Starting and Stopping the Engine

STARTING AND STOPPING THE ENGINE – TROUBLESHOOTING

STARTING AND STOPPING THE ENGINE – WARNING LAMPS

Malfunction Indicator Lamp



If it illuminates when the engine is running, the on-board diagnostics system is detecting a malfunction of the vehicle emission control system.

If it flashes, engine misfire could be occurring. Increased exhaust gas temperatures could damage the catalytic converter or other vehicle components. Avoid heavy acceleration and deceleration, and have your vehicle checked as soon as possible.

Powertrain Warning Lamp



If it illuminates when the engine is running, this indicates a powertrain or four-wheel drive fault. If it flashes when you are driving, immediately reduce the vehicle speed. Avoid heavy acceleration and deceleration, and have your vehicle checked as soon as possible.

If both lamps illuminate when the engine is running, stop your vehicle as soon as it is safe to do so. Continuing to drive your vehicle could cause reduced power or the engine to stop. Switch the ignition off and attempt to restart the engine. Have your vehicle checked as soon as possible.

STARTING AND STOPPING THE ENGINE – INFORMATION MESSAGES

| Message | Action |
|------------------------|---|
| Cranking Time Exceeded | Displays if you exceed the starting time limit. You cannot attempt to start the engine for 15 minutes. If you cannot start the engine after 15 minutes passes, have your vehicle immediately checked. |
| Starting System Fault | Displays if you are unable to start your vehicle with a correctly coded key. The system has detected a fault that requires service. Have your vehicle checked as soon as possible. |
| No Key Detected | Displays if the system does not detect a valid passive key. |

Starting and Stopping the Engine

STARTING AND STOPPING THE ENGINE – FREQUENTLY ASKED QUESTIONS - GASOLINE, VEHICLES WITHOUT: PUSH BUTTON START

Why is the engine idle speed high when I am starting the engine?

The speed at which the engine idles immediately after starting is optimized to minimize vehicle emissions and maximize cabin comfort and fuel economy.

Why does the engine not crank?

You can only attempt to start the engine for a limited amount of time before the starting system temporarily disables. If you exceed the starting time limit, a message may appear and you cannot attempt to start the engine for at least 15 minutes.

Why do I experience different driving characteristics?

If you disconnect the battery, your vehicle may exhibit some unusual driving characteristics for approximately 5 mi (8 km) after you reconnect it. This is because the engine management system must realign itself with the engine. You can disregard any unusual driving characteristics during this period.

Why can I not start the engine?

If you cannot start the engine after 3 attempts, wait 10 seconds and do the following:

1. Fully press the brake pedal or the clutch pedal.

Note: Make sure that the parking brake is applied.

Note: Make sure that the transmission is in park (P) or neutral (N).

2. Fully press the accelerator pedal and hold it there.



3. Turn the key to position **///** and wait until the engine stops cranking.
4. Release the accelerator pedal.
5. Turn the key to position **///**.

STARTING AND STOPPING THE ENGINE – FREQUENTLY ASKED QUESTIONS - GASOLINE, VEHICLES WITH: PUSH BUTTON START

Why is the engine idle speed high when I am starting the engine?

The speed at which the engine idles immediately after starting is optimized to minimize vehicle emissions and maximize cabin comfort and fuel economy.

Why does the engine not crank?

You can only attempt to start the engine for a limited amount of time before the starting system temporarily disables. If you exceed the starting time limit, a message may appear and you cannot attempt to start the engine for at least 15 minutes.

Starting and Stopping the Engine

Why do I experience different driving characteristics?

If you disconnect the battery, your vehicle may exhibit some unusual driving characteristics for approximately 5 mi (8 km) after you reconnect it. This is because the engine management system must realign itself with the engine. You can disregard any unusual driving characteristics during this period.

Why can I not start the engine?

If you cannot start the engine after 3 attempts, wait 10 seconds and do the following:

1. Fully press the brake pedal or the clutch pedal.

Note: Make sure that the parking brake is applied.

Note: Make sure that the transmission is in park (P) or neutral (N).

2. Fully press the accelerator pedal and hold it there.
3. Press the push button ignition switch.

Note: The engine cranks for a short period of time and then it stops.

4. Release the accelerator pedal.



5. Press the push button ignition switch.

Why does the system not detect a passive key?

If the system does not detect a passive key and you are unable to start the engine, insert the passive key into the backup position and press the push button ignition switch to start the engine. See **Accessing the Passive Key Backup Position** (page 237).

Hybrid Electric Vehicle Information (If Equipped)

WHAT IS A HYBRID ELECTRIC VEHICLE

A hybrid vehicle has an electric motor and a high voltage battery combined with a gasoline engine.

HOW DOES A HYBRID ELECTRIC VEHICLE WORK

The hybrid vehicle combines electric and gasoline propulsion to provide optimal performance and improved efficiency.

HYBRID ELECTRIC VEHICLE DRIVING CHARACTERISTICS

The gasoline engine starts and stops to provide power when required and to save fuel when not needed. When coasting at low speeds, coming to a stop or standing, the gas engine normally shuts down and your vehicle operates in electric-only mode.

Conditions that may cause the gasoline engine to start or remain running include:

- Considerable vehicle acceleration.
- Driving uphill.
- The high voltage battery charge level is low.
- Heating or cooling the vehicle interior in high or low outside temperatures.
- The gasoline engine is below normal operating temperature.
- Towing a trailer.
- Certain selectable drive modes could cause the engine to run. See **Selecting a Drive Mode** (page 350). Use of the paddle shifters while in drive (D) could cause the engine to run.

Your hybrid vehicle also comes with standard hydraulic braking and regenerative braking. Regenerative braking is performed by your transmission and captures brake energy and stores it in the high voltage battery.

You could also notice that your engine continues to run instead of shutting off during extended downhill driving. The engine stays on during this engine braking but is not using any fuel.

You could also hear a slight whine or whistle when operating your vehicle. This is the normal operation of the electric motor in the hybrid system.

HYBRID ELECTRIC VEHICLE INDICATORS

READY When you start your vehicle, a green READY indicator light appears in the instrument cluster letting you know that your vehicle is ready for driving.

The engine may not start because your vehicle has a silent key start feature. This fuel saving feature allows your vehicle to be ready to drive without requiring the gas engine to be running.

The indicator remains on when your vehicle is on, whether the engine is running or not, to indicate your vehicle is capable of movement using the electric motor, gas engine or both.

Typically, the engine does not start unless the vehicle is cold, a climate control change is requested or you press the accelerator pedal.

Hybrid Electric Vehicle Information (If Equipped)

HYBRID ELECTRIC VEHICLE INFORMATION – TROUBLESHOOTING

HYBRID ELECTRIC VEHICLE INFORMATION – FREQUENTLY ASKED QUESTIONS

How long is the high voltage battery system designed to last?

The high voltage battery system is designed to last the life of your vehicle.

Does the high voltage battery require maintenance?

The high voltage battery does not require maintenance.

What should I do if the vehicle runs out of fuel and the high voltage battery is out of charge?

Refuel and start your vehicle normally. The engine will recharge the high voltage battery.

Why does the engine sometimes start at key-on?

The vehicle's computer will determine if an engine start is required at key-on. It starts the engine when necessary for cabin heating, windshield defrost, or if the outside temperature is low.

Can I put E15 or E85 in my vehicle, and how will it affect my fuel economy?

Your hybrid vehicle can use E15 (15% ethanol, 85% gasoline) fuel, but you may notice slightly reduced fuel economy because ethanol contains less energy per gallon than gasoline. Your hybrid vehicle is not designed to use E85 (85% ethanol).

Why does it take a long time before the engine shuts down?

There are several reasons the engine stays on for an extended amount of time when you first start it. One common reason is to make sure that the emissions components are warm enough to minimize tailpipe emission. As the climate gets cooler, the engine-on time is extended.

Why does my engine stay on when it is extremely cold outside?

In order to make sure that the climate control system can begin heating the cabin or defrosting the windshield as soon as a driver requests it, the engine coolant temperature has to be kept sufficiently hot. Keeping the engine on is required to maintain the correct coolant temperature.

ECO IDLE

WHAT IS ECO IDLE

Eco idle reduces fuel consumption when your vehicle is in park (P) and idling for long periods of time. Eco idle more efficiently extends the use of features that are powered by the high voltage battery when your vehicle is stationary.

HOW DOES ECO IDLE WORK

Eco idle increases the engine idle speed above normal for a short period of time to efficiently charge the high voltage battery.

Note: *Engine sound and vibration could be more noticeable.*

SWITCHING ECO IDLE ON AND OFF

To switch eco idle on and off use the touchscreen:

Hybrid Electric Vehicle Information (If Equipped)

1. Press **Settings** on the touchscreen.
2. Press **Vehicle Settings**.
3. Switch **ECO Idle** on or off.

Note: *Your vehicle must be in park (P) for eco idle to be available.*

ECO IDLE – TROUBLESHOOTING

ECO IDLE – FREQUENTLY ASKED QUESTIONS

Why is the engine idling so loudly?

The engine is running at higher idle speeds to charge the high voltage battery. This is normal operation.

Auto-Start-Stop (If Equipped)

WHAT IS AUTO-START-STOP

The system is designed to help reduce fuel consumption and CO₂ emissions by stopping the engine when it is idling, for example at traffic lights.

AUTO-START-STOP PRECAUTIONS



WARNING: Apply the parking brake, shift into park (P), switch the ignition off and remove the key before you leave your vehicle. Failure to follow this instruction could result in personal injury or death.



WARNING: Apply the parking brake, shift into park (P), switch the ignition off and remove the key before you open the hood or have any service or repair work completed. If you do not switch the ignition off, the engine could restart at any time. Failure to follow this instruction could result in personal injury or death.

SWITCHING AUTO-START-STOP ON AND OFF

The system turns on when you switch the ignition on.



Press the button to switch the system off.

Note: *OFF* illuminates in the switch.

Note: *Deactivating the system using the button lasts only one key cycle.*

Press the button again to switch the system back on.

Note: *The system turns off if it detects a malfunction. If the system malfunctions, have your vehicle checked as soon as possible.*

STOPPING THE ENGINE

Stop your vehicle, keep your foot on the brake pedal and the transmission in drive (D).

RESTARTING THE ENGINE

Release the brake pedal or press the accelerator pedal.

A message appears in the information display if the system requires you to take action.

AUTO-START-STOP INDICATORS



WARNING: The system may require the engine to automatically restart when the auto-start-stop indicator illuminates green or flashes amber. Failure to follow this instruction could result in personal injury.



The Auto-Start-Stop indicator illuminates green when the engine stops. It flashes amber and a message appears when you need to take action.



The Auto-Start-Stop indicator illuminates gray with a strikethrough when the system is not available.

Note: *You can display the reason why the system is not available in the information display.*

Auto-Start-Stop (If Equipped)

AUTO-START-STOP – TROUBLESHOOTING

AUTO-START-STOP – INFORMATION MESSAGES

A message appears in the information display if the system requires you to take action.

| Message | Condition | Action |
|--|--|---|
| Auto StartStop Press Brake to Start Engine | The system needs to restart the engine but requires your confirmation. | Press the brake pedal to restart the engine. |
| Auto StartStop Press a Pedal to Start Engine | The system needs to restart the engine but requires your confirmation. | Press the brake pedal or the accelerator pedal to restart the engine. |

Auto-Start-Stop (If Equipped)

AUTO-START-STOP – FREQUENTLY ASKED QUESTIONS

Why does the engine not always stop when I expect it to?

The system is designed to work in a way that complements other vehicle systems, allowing them to operate at optimum performance.

The system does not stop the engine if:

- The driver door is open.
- Your vehicle is at high altitude.
- The heated windshield is on.
- The engine is warming up.
- The outside temperature is too low or too high.
- The battery charge is low.
- The battery temperature is outside the optimal operating range.
- The engine is required to run to maintain interior climate and reduce fogging.

Why does the engine sometimes restart when I do not expect it to?

The system is designed to work in a way that complements other vehicle systems, allowing them to operate at optimum performance.

The system restarts the engine if:

- You switch the heated windshield on.
- You switch maximum defrost on.
- Your vehicle starts to roll downhill in neutral.
- The engine is required to run to maintain adequate brake system assistance.
- The engine is required to run to maintain interior climate and reduce fogging.

Can I permanently switch the system off?

No. The system plays an important role in reducing the fuel consumption and the CO₂ emissions.

Will the frequent engine starts cause parts to wear out?

Your vehicle has an enhanced battery and starter motor that are designed for the increased number of engine starts.

Fuel and Refueling

FUEL AND REFUELING PRECAUTIONS



WARNING: Do not overfill the fuel tank. The pressure in an overfilled tank may cause leakage and lead to fuel spray and fire.



WARNING: The fuel system may be under pressure. If you hear a hissing sound near the fuel filler inlet, do not refuel until the sound stops. Otherwise, fuel may spray out, which could cause serious personal injury.



WARNING: Fuels can cause serious injury or death if misused or mishandled.



WARNING: Fuel may contain benzene, which is a cancer-causing agent.



WARNING: When refueling always shut the engine off and never allow sparks or open flames near the fuel tank filler valve. Never smoke or use a cell phone while refueling. Fuel vapor is extremely hazardous under certain conditions. Avoid inhaling excess fumes.



WARNING: Read and follow all the instructions on the pump island.

Follow these guidelines when refueling:

- Extinguish all smoking materials and any open flames before refueling your vehicle.
- Switch the engine off before refueling.
- Automotive fuels can be harmful or fatal if swallowed. Fuel is highly toxic and if swallowed can cause death or permanent injury. If fuel is swallowed immediately call a physician, even if no symptoms are immediately apparent. The toxic effects of fuel may not be apparent for hours.
- Avoid inhaling fuel vapors. Inhaling fuel vapor can lead to eye and respiratory tract irritation. In severe cases, excessive or prolonged breathing of fuel vapor can cause serious illness and permanent injury.
- Avoid getting fuel in your eyes. If you splash fuel in your eyes, immediately remove contact lenses, if worn, flush with water for 15 minutes and seek medical attention. Failure to seek proper medical attention could lead to permanent injury.
- Fuels can be harmful if absorbed through the skin. If you splash fuel on your skin, clothing or both, promptly remove contaminated clothing and thoroughly wash your skin with soap and water. Repeated or prolonged skin contact causes skin irritation.
- Be particularly careful if you are taking Antabuse or other forms of Disulfiram for the treatment of alcoholism. Breathing fuel vapors could cause an adverse reaction, serious personal injury or sickness. Immediately call a physician if you experience any adverse reactions.

Fuel and Refueling

FUEL QUALITY

SELECTING THE CORRECT FUEL - FLEX FUEL – ETHANOL

Flex fuel vehicles have one of the following identifiers:

- Yellow fuel filler cap.
- Yellow bezel around the fuel filler inlet.
- Yellow fuel filler housing.
- Yellow E85 label on the fuel tank filler door.

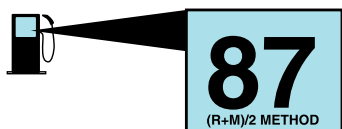

Your vehicle operates on regular unleaded gasoline with a minimum pump (R+M)/2 octane rating of 87 or regular unleaded gasoline blended with a maximum of 85% ethanol (E85).

Some fuel stations, particularly those in high altitude areas, offer fuels posted as regular unleaded gasoline with an octane rating below 87. The use of these fuels could result in engine damage that will not be covered by the vehicle Warranty.

For best overall vehicle and engine performance, premium fuel with an octane rating of 91 or higher is recommended. The performance gained by using premium fuel is most noticeable in hot weather as well as other conditions, for example when towing a trailer. See **Towing a Trailer** (page 403).

Do not be concerned if the engine sometimes knocks lightly. However, if the engine knocks heavily while using fuel with the recommended octane rating, contact an authorized dealer to prevent any engine damage.

We recommend Top Tier detergent gasolines, where available to help minimize engine deposits and maintain optimal vehicle and engine performance.

For additional information, visit www.toptiergas.com.

Note: *Use of any fuel for which the vehicle was not designed can impair the emission control system, cause loss of vehicle performance, and cause damage to the engine which may not be covered by the vehicle Warranty.*

Do not use:

- Diesel fuel.
- Fuels containing kerosene or paraffin.
- Fuels containing more than 85% ethanol or E100 fuel.
- Fuels containing methanol.
- Fuels containing metallic-based additives, including manganese-based compounds.
- Fuels containing the octane booster additive, methylcyclopentadienyl manganese tricarbonyl (MMT).
- Leaded fuel, using leaded fuel is prohibited by law.

The use of fuels with metallic compounds such as methylcyclopentadienyl manganese tricarbonyl, which is a manganese-based fuel additive, will impair engine performance and affect the emission control system.

Fuel and Refueling

SELECTING THE CORRECT FUEL - GASOLINE



Your vehicle operates on regular unleaded gasoline with a minimum pump (R+M)/2 octane rating of 87.

Some fuel stations, particularly those in high altitude areas, offer fuels posted as regular unleaded gasoline with an octane rating below 87. The use of these fuels could result in engine damage that will not be covered by the vehicle Warranty.

For best overall vehicle and engine performance, premium fuel with an octane rating of 91 or higher is recommended. The performance gained by using premium fuel is most noticeable in hot weather as well as other conditions, for example when towing a trailer. See **Towing a Trailer** (page 403).

Do not be concerned if the engine sometimes knocks lightly. However, if the engine knocks heavily while using fuel with the recommended octane rating, contact an authorized dealer to prevent any engine damage.

We recommend Top Tier detergent gasolines, where available to help minimize engine deposits and maintain optimal vehicle and engine performance.

For additional information, visit www.toptiergas.com.

Note: Use of any fuel for which the vehicle was not designed can impair the emission control system, cause loss of vehicle performance, and cause damage to the engine which may not be covered by the vehicle Warranty.

Do not use:

- Diesel fuel.
- Fuels containing kerosene or paraffin.
- Fuel containing more than 15% ethanol or E85 fuel.
- Fuels containing methanol.
- Fuels containing metallic-based additives, including manganese-based compounds.
- Fuels containing the octane booster additive, methylcyclopentadienyl manganese tricarbonyl (MMT).
- Leaded fuel, using leaded fuel is prohibited by law.

The use of fuels with metallic compounds such as methylcyclopentadienyl manganese tricarbonyl, which is a manganese-based fuel additive, will impair engine performance and affect the emission control system.

SWITCHING BETWEEN E85 AND GASOLINE

We do not recommend repeatedly alternating between E85 and gasoline. If you switch from using E85 to gasoline, or from gasoline to E85, add as much fuel as possible, at least half a tank. Drive your vehicle immediately for a minimum of 5 mi (8 km) to allow it to adapt to the change in ethanol concentration. If you use E85 exclusively, we recommend that you fill the fuel tank with regular unleaded gasoline at each scheduled oil change.

Fuel and Refueling

LOCATING THE FUEL FILLER FUNNEL

Regular Cab

The fuel filler funnel is behind the right-hand front seat.

Super Cab/Crew Cab

The fuel filler funnel is under the second row right-hand rear seat.

RUNNING OUT OF FUEL

FILLING A PORTABLE FUEL CONTAINER



WARNING: Flow of fuel through a fuel pump nozzle can produce static electricity. This can cause a fire if you are filling an ungrounded fuel container.

Use the following guidelines to avoid electrostatic charge build-up, which can produce a spark, when filling an ungrounded fuel container:

- Only use an approved fuel container to transfer fuel to your vehicle. Place the container on the ground when filling it.
- Do not fill a fuel container when it is inside your vehicle (including the cargo area).
- Keep the fuel pump nozzle in contact with the fuel container when filling it.
- Do not use a device that holds the fuel pump nozzle lever in the fill position.

ADDING FUEL FROM A PORTABLE FUEL CONTAINER



WARNING: Do not insert the nozzle of a fuel container or an aftermarket funnel into the fuel filler neck. This may damage the fuel system filler neck or its seal and cause fuel to run onto the ground.



WARNING: Do not pry open the fuel tank filler valve. This could damage the fuel system. Failure to follow this instruction could result in fire, personal injury or death.



WARNING: Do not dispose of fuel in the household refuse or the public sewage system. Use an authorized waste disposal facility.

When refueling the vehicle fuel tank from a fuel container, use the fuel filler funnel included with your vehicle. See **Locating the Fuel Filler Funnel** (page 250).

Note: *Do not use aftermarket funnels as they may not work with the capless fuel system and can damage it.*

When refueling the vehicle fuel tank from a fuel container, do the following:

1. Fully open the fuel filler door.

Fuel and Refueling



2. Fully insert the fuel filler funnel into the fuel filler inlet.
3. Add fuel to your vehicle from the fuel container.
4. Remove the fuel filler funnel.
5. Fully close the fuel filler door.
6. Clean the fuel filler funnel and place it back in your vehicle or correctly dispose of it.

Note: If your vehicle runs out of fuel add a minimum of 1.3 gal (5 L) of fuel to restart the engine.

Note: You may need to switch the ignition from off to on several times after refueling to allow the fuel system to pump the fuel from the tank to the engine. When restarting, cranking time takes a few seconds longer than normal.

Note: Extra funnels can be purchased from an authorized dealer if you choose to dispose of the funnel.

REFUELING

REFUELING SYSTEM OVERVIEW

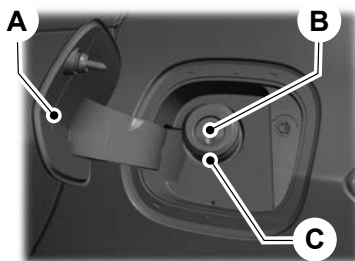

- A Fuel filler door.
- B Fuel filler inlet.
- C Fuel tank filler pipe.

REFUELING YOUR VEHICLE - EXCLUDING: HYBRID ELECTRIC VEHICLE (HEV)

⚠ WARNING: When refueling always shut the engine off and never allow sparks or open flames near the fuel tank filler valve. Never smoke or use a cell phone while refueling. Fuel vapor is extremely hazardous under certain conditions. Avoid inhaling excess fumes.

⚠ WARNING: Fuel vapor burns violently and a fuel fire can cause severe injuries.

⚠ WARNING: The fuel system may be under pressure. If you hear a hissing sound near the fuel filler inlet, do not refuel until the sound stops. Otherwise, fuel may spray out, which could cause serious personal injury.

Fuel and Refueling

WARNING: Keep children away from the fuel pump. Never let children pump fuel.

WARNING: Do not pry open the fuel tank filler valve. This could damage the fuel system. Failure to follow this instruction could result in fire, personal injury or death.

WARNING: Stay outside your vehicle and do not leave the fuel pump unattended when refueling your vehicle.

WARNING: Do not remove the fuel pump nozzle from its fully inserted position when refueling.

WARNING: Stop refueling when the fuel pump nozzle automatically shuts off for the first time. Failure to follow this will fill the expansion space in the fuel tank and could lead to fuel overflowing.

WARNING: Do not overfill the fuel tank. The pressure in an overfilled tank may cause leakage and lead to fuel spray and fire.

WARNING: Wait at least five seconds before removing the fuel pump nozzle to allow any residual fuel to drain into the fuel tank.

1. Fully open the fuel filler door.
2. Select the correct fuel pump nozzle for your vehicle.

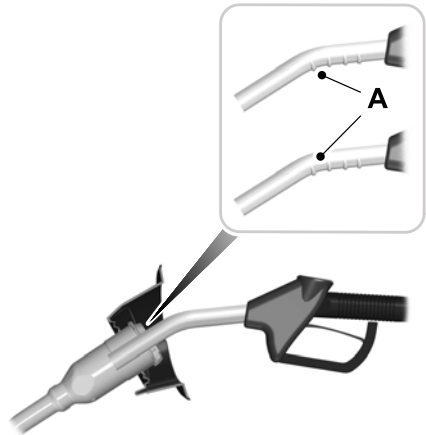

3. Insert the fuel pump nozzle up to the first notch. Keep the fuel pump nozzle resting on the fuel tank filler pipe.

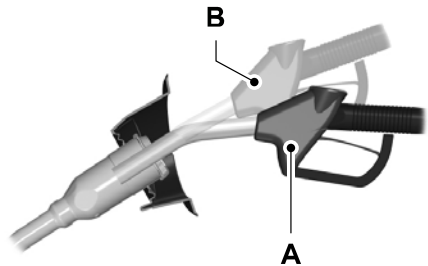

4. Hold the fuel pump nozzle in position A when refueling. Holding the fuel pump nozzle in position B can affect the flow of fuel and shut off the fuel pump nozzle before the fuel tank is full.

Fuel and Refueling



5. Operate the fuel pump nozzle within the area shown.

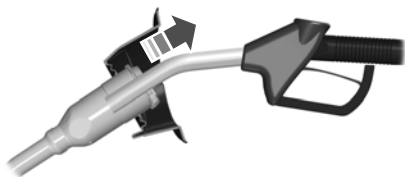

6. When the pump shuts off, wait five seconds, then raise the fuel pump nozzle and slowly remove it.
7. Fully close the fuel filler door.

Note: Do not attempt to start the engine if you have filled the fuel tank with incorrect fuel. Incorrect fuel use could cause damage not covered by the vehicle Warranty. Have your vehicle immediately checked.

REFUELING YOUR VEHICLE - HYBRIDELECTRIC VEHICLE (HEV)

WARNING: When refueling always shut the engine off and never allow sparks or open flames near the fuel tank filler valve. Never smoke or use a cell phone while refueling. Fuel vapor is extremely hazardous under certain conditions. Avoid inhaling excess fumes.

WARNING: The fuel system may be under pressure. If you hear a hissing sound near the fuel filler inlet, do not refuel until the sound stops. Otherwise, fuel may spray out, which could cause serious personal injury.

WARNING: Fuel vapor burns violently and a fuel fire can cause severe injuries.

WARNING: Keep children away from the fuel pump. Never let children pump fuel.

WARNING: Stay outside your vehicle and do not leave the fuel pump unattended when refueling your vehicle.

WARNING: Do not pry open the fuel tank filler valve. This could damage the fuel system. Failure to follow this instruction could result in fire, personal injury or death.

WARNING: Do not remove the fuel pump nozzle from its fully inserted position when refueling.

WARNING: Stop refueling when the fuel pump nozzle automatically shuts off for the first time. Failure to follow this will fill the expansion space in the fuel tank and could lead to fuel overflowing.

WARNING: Do not overfill the fuel tank. The pressure in an overfilled tank may cause leakage and lead to fuel spray and fire.

WARNING: Wait at least five seconds before removing the fuel pump nozzle to allow any residual fuel to drain into the fuel tank.

Fuel and Refueling

1. When you stop your vehicle, shift into park (P) and switch the ignition off.



2. Press the button on the left side of the instrument panel next to the headlamp switch to open the fuel filler door. The fuel filler door can take up to 15 seconds to open before you can insert a fuel filler nozzle.
3. Select the correct fuel pump nozzle for your vehicle.

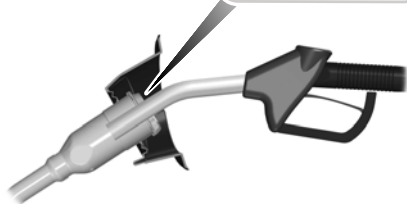
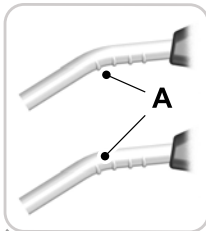

4. Insert the fuel pump nozzle up to the first notch. Keep the fuel pump nozzle resting on the fuel tank filler pipe.

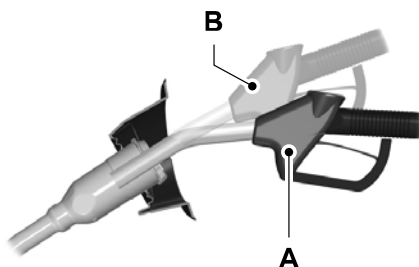

5. Hold the fuel pump nozzle in position A when refueling. Holding the fuel pump nozzle in position B can affect the flow of fuel and shut off the fuel pump nozzle before the fuel tank is full.

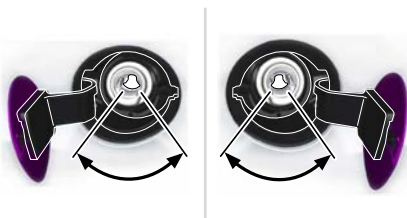

6. Operate the fuel pump nozzle within the area shown.

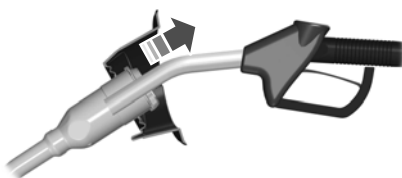

7. When the pump shuts off, wait 5 seconds, then raise the fuel pump nozzle and slowly remove it.
8. Fully close the fuel filler door.

Fuel and Refueling

Note: To close the fuel filler door, press the center rear edge of the fuel filler door and then release.

Complete the refueling process within 20 minutes. If 20 minutes elapses, press the button on the left side of the instrument panel again. Fuel pump nozzle automatic shut off could occur if you do not press the button on the left side instrument panel.

Note: Do not attempt to start the engine if you have filled the fuel tank with incorrect fuel. Incorrect fuel use could cause damage not covered by the vehicle Warranty. Have your vehicle immediately checked.

MANUALLY OPENING THE FUEL FILLER DOOR - EXCLUDING: HYBRIDELECTRIC VEHICLE (HEV)

Your vehicle does not have a fuel tank filler cap.

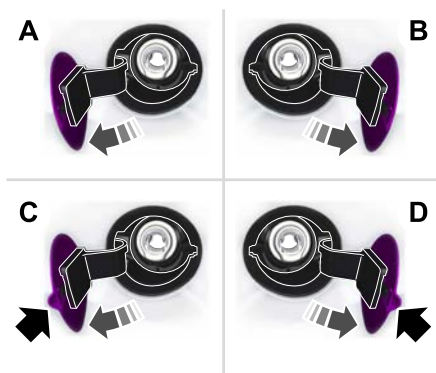

- A Left-hand side. To open the fuel filler door, press the center rear edge of the fuel filler door and then release.
- B Right-hand side. To open the fuel filler door, press the center rear edge of the fuel filler door and then release.
- C Left-hand side. Pull the rear of the fuel filler door to open it.
- D Right-hand side. Pull the rear of the fuel filler door to open it.

MANUALLY OPENING THE FUEL FILLER DOOR - HYBRID ELECTRIC VEHICLE (HEV)

Note: The transmission must be in park (P) or neutral (N).

To manually open the fuel door do the following:

Fuel and Refueling

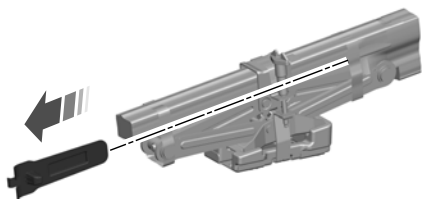

1. Retrieve the emergency opening tool.

Note: The emergency opening tool is with the jack and tool bag. See **Changing a Flat Tire** (page 543).



2. Insert the emergency opening tool in the position shown and gently pry the fuel door open.

Note: Do not press the fuel filler door release button if the emergency opening tool has been used.

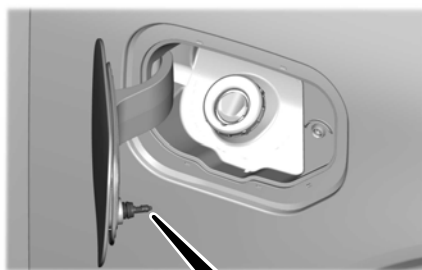

Using the emergency opening tool can cause the tappet to temporarily dislodge from the fuel filler door and remain attached to the fuel filler door opening. If you press the fuel filler door release button after using the emergency opening tool, locate the tappet and reinsert it into the fuel door.

FUEL TANK CAPACITY - EXCLUDING: HYBRID ELECTRIC VEHICLE (HEV)

Advertised Capacity

The advertised capacity is the maximum amount of fuel that you can add to the fuel tank after running out of fuel. Included in the advertised capacity is an empty reserve. The empty reserve is an unspecified amount of fuel that remains in the fuel tank when the fuel gauge indicates empty.

Note: The amount of fuel in the empty reserve varies and should not be relied upon to increase driving range.

Fuel and Refueling

FUEL TANK CAPACITY - HYBRID ELECTRIC VEHICLE (HEV)

Advertised Capacity

The advertised capacity is the maximum amount of fuel that you can add to the fuel tank when the fuel gauge indicates empty.

In addition, the fuel tank contains an empty reserve. The empty reserve is an unspecified amount of fuel that remains in the fuel tank when the fuel gauge indicates empty.

Note: *The amount of fuel in the empty reserve varies and should not be relied upon to increase driving range.*

FUEL AND REFUELING – TROUBLESHOOTING

FUEL AND REFUELING – WARNING LAMPS



If it illuminates when you are driving, refuel as soon as possible.

FUEL AND REFUELING – INFORMATION MESSAGES

| Message | Action |
|--|--|
| Fuel Level Low | An early reminder of a low fuel condition. |
| Check Fuel Fill Inlet | The fuel fill inlet may not be properly closed. |
| Please wait for fuel door to open | The information message appears while the fuel system is depressurizing with the fuel filler door closed. Wait for the fuel system to depressurize and for the fuel filler door to unlatch. |
| Fuel Door Open | The information message appears when the fuel system has depressurized and opened the fuel filler door. Fully open the fuel filler door to refuel and fully close the fuel filler door when refueling is complete. |
| Fuel door ajar Close fully to avoid "Check Engine" light | Your vehicle is equipped with a sealed fuel system that requires the fuel filler door to be fully closed after refueling. This warning message appears when the fuel filler door is ajar. Please fully close the fuel filler door to avoid a "Check Engine" Light. If you see this message and a "Check Engine" lamp illuminates, please fully close the fuel filler door. The "Check Engine" Light should clear within five seconds. If the "Check Engine" light persists, please see your dealer. |
| Refuel Error See Manual | The information message appears when the fuel system fails to depressurize, or the fuel filler door fails to open. You could have to use the fuel filler door manual override lever when opening the fuel door. |

Catalytic Converter

WHAT IS THE CATALYTIC CONVERTER

The catalytic converter is part of your vehicle's emissions system and filters harmful pollutants from the exhaust gas.

CATALYTIC CONVERTER PRECAUTIONS



WARNING: Do not park, idle or drive your vehicle on dry grass or other dry ground cover. The emission system heats up the engine compartment and exhaust system, creating the risk of fire.



WARNING: The normal operating temperature of the exhaust system is very high. Never work around or attempt to repair any part of the exhaust system until it has cooled. Use special care when working around the catalytic converter. The catalytic converter heats up to a very high temperature after only a short period of engine operation and stays hot after the engine is switched off.



WARNING: Exhaust leaks may result in entry of harmful and potentially lethal fumes into the passenger compartment. If you smell exhaust fumes inside your vehicle, have your vehicle inspected immediately. Do not drive if you smell exhaust fumes.

To avoid damaging the catalytic converter:

- Do not crank the engine for more than 10 seconds at a time.
- Do not run the engine with a spark plug lead disconnected.
- Do not push-start or tow-start your vehicle. Use booster cables. See **Jump Starting the Vehicle** (page 465).

- Use the correct fuel. See **Fuel and Refueling** (page 247).
- Do not switch the ignition off when your vehicle is moving.
- Avoid running out of fuel.
- Have the items listed in scheduled maintenance information performed according to the specified schedule.

Note: Do not make any unauthorized changes to your vehicle or engine. By law, vehicle owners and anyone who manufactures, repairs, or services a fleet of vehicles are not permitted to intentionally remove an emission control device or prevent it from working.

CATALYTIC CONVERTER – TROUBLESHOOTING

CATALYTIC CONVERTER – WARNING LAMPS

Your vehicle has an on-board diagnostics system that monitors the emission control system. If any of the following warning lamps illuminate, this may indicate that the on-board diagnostics system has detected an emission control system malfunction.



Continuing to drive your vehicle may cause reduced power or the engine to stop. Failure to respond to a warning lamp may cause damage that your vehicle Warranty may not cover. Have your vehicle checked as soon as possible.

High Voltage Battery - Hybrid Electric Vehicle (HEV)

WHAT IS THE HIGH VOLTAGE BATTERY

The high voltage battery is a highly sophisticated lithium ion battery system, used to store electrified propulsion energy to power the vehicle.

HIGH VOLTAGE BATTERY PRECAUTIONS



WARNING: This battery pack should only be serviced by an authorized electric vehicle technician. Improper handling can result in personal injury or death.



WARNING: Apply the parking brake, shift into park (P), switch the ignition off and remove the key before you open the hood or have any service or repair work completed. If you do not switch the ignition off, the engine could restart at any time. Failure to follow this instruction could result in personal injury or death.



WARNING: Do not touch the electronic ignition system parts after you have switched the ignition on or when the engine is running. The system operates at high voltage. Failure to adhere to this warning could result in serious personal injury or death.



WARNING: Keep your hands and clothing clear of the engine cooling fan.

Automatic Transmission

AUTOMATIC TRANSMISSION PRECAUTIONS



WARNING: Apply the parking brake, shift into park (P), switch the ignition off and remove the key before you leave your vehicle. Failure to follow this instruction could result in personal injury or death.



WARNING: When your vehicle is stationary, keep the brake pedal fully pressed when shifting gears. Failure to follow this instruction could result in personal injury, death or property damage.



WARNING: Do not apply the brake pedal and accelerator pedal simultaneously. Applying both pedals simultaneously for more than a few seconds will limit engine performance, which may result in difficulty maintaining speed in traffic and could lead to serious injury.

AUTOMATIC TRANSMISSION POSITIONS

PARK (P)



WARNING: Shift into park (P) only when your vehicle is stationary.

In park (P) power is not transmitted to the driven wheels.

Note: A tone sounds if you attempt to exit your vehicle without the transmission in park (P).

Note: Your vehicle may not shift out of park (P) if the vehicle battery has run out of charge.

Note: Your vehicle may not shift out of park (P) if a fuse is blown. See **Fuses** (page 472).

Note: Your vehicle may not shift out of park (P) unless the key or remote control is inside your vehicle.

Note: Your vehicle could shift into park (P) if you attempt to exit your vehicle without the transmission in park (P). See **How Does Automatic Return to Park (P) Work** (page 265).

Note: If you shift into park (P) without fully pressing the brake, the parking brake could apply. If you shift into park (P) on a slope, the parking brake could apply. See **Automatically Releasing the Electric Parking Brake** (page 289).

Note: A tone could sound when you select park (P).

REVERSE (R)



WARNING: Shift into reverse (R) only when your vehicle is stationary.

In reverse (R) power is transmitted to the driven wheels.

NEUTRAL (N)



WARNING: In neutral (N) your vehicle is free to roll.

In neutral (N) power is not transmitted to the driven wheels.

DRIVE (D)

In drive (D) power is transmitted to the driven wheels.

Automatic Transmission

MANUAL (M)

To select manual mode press the (M) button on the shifter.

Note: *In order to activate manual mode your vehicle must be in drive (D).*

This position allows you to change gears up or down as preferred using + or - buttons on the shifter lever.

To return to the normal drive (D) position, press the (M) button again to exit manual mode.

SHIFTING YOUR VEHICLE INTO GEAR

Console Shifter

The transmission selector is on the center console.



1. Press and hold the brake pedal.
2. Move the lever to select a position.

Note: *The position illuminates on the transmission selector.*

3. Press the manual (M) button when your vehicle is in drive (D) to enter or exit a mode.

Column Shifter

The transmission selector is on the steering column.



1. Press and hold the brake pedal.
2. Move the lever to select a position.
3. Press the manual (M) button when your vehicle is in drive (D) to enter or exit a mode.

SHIFTING YOUR VEHICLE INTO GEAR - RAPTOR

The transmission selector is on the center console.



1. Press and hold the brake pedal.
2. Move the lever to select a position.

Automatic Transmission

Note: The position illuminates on the transmission selector.

3. Press the manual (M) button when your vehicle is in drive (D) to enter or exit a mode.

SHIFTING YOUR VEHICLE INTO GEAR - POLICE RESPONDER

The transmission selector is on the steering column.



1. Press and hold the brake pedal.
2. Move the lever to select a position.
3. Press the manual (M) button when your vehicle is in drive (D) to enter or exit a mode.

MANUALLY SHIFTING GEARS

SHIFTING USING THE PADDLE SHIFTERS - RAPTOR

The instrument cluster displays the current gear. The current gear flashes when your vehicle cannot shift into the requested gear. Your vehicle will not shift if the requested gear raises or lowers the engine speed beyond the limit.

Your vehicle could shift when you fully press the accelerator or brake pedal.

Note: Prolonged driving with high engine speed could cause vehicle damage not covered by the vehicle warranty.

Note: Drive modes could affect when the vehicle shifts into the requested gear.



Manually Shifting Gears in Drive (D)

Use this feature to temporarily change gears.

Note: We recommend using this feature for engine braking or driving on hilly or mountainous roads.

- Pull any paddle to switch the feature on.
- Pull the right (+) paddle to upshift.
- Pull the left (-) paddle to downshift.
- Hold the (+) paddle for a few seconds to switch the feature off.

Note: The feature switches off after a short period of time if you do not pull either paddle.

Manually Shifting Gears in Manual (M)

Use this feature to select a specific gear.

Note: We recommend using this feature for engine braking, driving on hilly or mountainous roads, or when towing a trailer. See **Towing a Trailer** (page 403).

- Shift to manual (M) to switch the feature on.
- Pull the right (+) paddle to upshift.

Automatic Transmission

- Pull the left (-) paddle to downshift.
- Shift to drive (D) to switch the feature off.

SHIFTING USING THE BUTTONS ON THE SELECTOR LEVER

Center Console Shifter

The instrument cluster displays the current gear. The current gear flashes when your vehicle cannot shift into the requested gear. Your vehicle will not shift if the requested gear raises or lowers the engine speed beyond the limit.

Your vehicle may shift when you fully press the accelerator or brake pedal.

Note: *Prolonged driving with high engine speed could cause vehicle damage not covered by the vehicle warranty.*

Note: *Drive modes could affect when the vehicle shifts into the requested gear.*

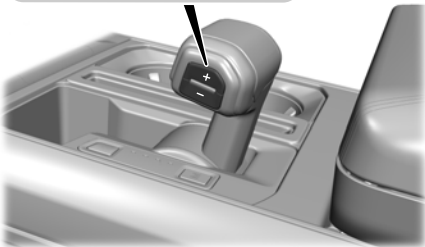

Manually Shifting Gears in Manual (M)

Use this feature to select a specific gear.

Note: *We recommend using this feature for engine braking, driving on hilly or mountainous roads, or when towing a trailer. See **Towing a Trailer** (page 403).*

- Shift to manual (M) to switch the feature on.
- Press the upper (+) button to upshift.
- Press the lower (-) button to downshift.
- Shift to drive (D) to switch the feature off.

Column Shifter

The instrument cluster displays the current gear. The current gear flashes when your vehicle cannot shift into the requested gear. Your vehicle will not shift if the requested gear raises or lowers the engine speed beyond the limit.

Your vehicle could shift when you fully press the accelerator or brake pedal.

Note: *Prolonged driving with high engine speed could cause vehicle damage not covered by the vehicle warranty.*

Note: *Drive modes could affect when the vehicle shifts into the requested gear.*



Manually Shifting Gears in Manual (M)

Use this feature to select a specific gear.

Automatic Transmission

Note: We recommend using this feature for engine braking, driving on hilly or mountainous roads, or when towing a trailer. See **Towing a Trailer** (page 403).

- Shift to manual (M) to switch the feature on.
- Press the upper (+) button to upshift.
- Press the lower (-) button to downshift.
- Shift to drive (D) to switch the feature off.

SHIFTING USING THE BUTTONS ON THE SELECTOR LEVER - POLICE RESPONDER

The instrument cluster displays the current gear. The current gear flashes when your vehicle cannot shift into the requested gear. Your vehicle will not shift if the requested gear raises or lowers the engine speed beyond the limit.

Your vehicle may shift when you fully press the accelerator or brake pedal.

Note: Prolonged driving with high engine speed could cause vehicle damage not covered by the vehicle warranty.

Note: Drive modes could affect when the vehicle shifts into the requested gear.



Manually Shifting Gears in Manual (M)

Use this feature to select a specific gear.

Note: We recommend using this feature for engine braking, driving on hilly or mountainous roads, or when towing a trailer. See **Towing a Trailer** (page 403).

- Shift to manual (M) to switch the feature on.
- Press the upper (+) button to upshift.
- Press the lower (-) button to downshift.
- Shift to drive (D) to switch the feature off.

TEMPORARY NEUTRAL MODE

WHAT IS TEMPORARY NEUTRAL MODE

This mode keeps your vehicle in neutral (N), for a limited time, when you exit your vehicle or switch your vehicle off.

Note: Do not tow your vehicle in this mode.

TEMPORARY NEUTRAL MODE LIMITATIONS

Your vehicle could shift to park (P) after 30 minutes, or when the vehicle battery charge level is low. Prolonged use of this mode can cause the vehicle battery to run out of charge.

Do not tow your vehicle in this mode. Failure to follow these instructions could result in vehicle damage not covered by the vehicle warranty.

ENTERING TEMPORARY NEUTRAL MODE

1. Power your vehicle on.
2. Bring your vehicle to a complete stop.

Automatic Transmission

3. Press and hold the brake pedal.

4. Shift into neutral (N).

Note: An instructional message appears.

5. Press the manual (M) button.

Note: A confirmation message appears when your vehicle enters the mode.

6. Release the brake pedal.

Note: Your vehicle is free to roll.

7. Switch your vehicle off.

Note: Do not tow your vehicle in this mode.

Note: The neutral (N) indicator on the transmission selector may flash in this mode.

EXITING TEMPORARY NEUTRAL MODE

1. Press the brake pedal.

2. Shift into park (P), or power your vehicle on and shift into drive (D) or reverse (R).

USING PROGRESSIVE RANGE SELECTION

Progressive range selection gives you the ability to lock out gears from the automatic shifting range. This could provide you with an improved driving experience by reducing transmission shifts, for example, in slippery conditions or steep slopes.

With the transmission in drive (D), press the - button to begin to switch the feature on.

Press the - button again to continue locking out higher gears. Beginning with the highest gear, the instrument cluster will indicate the current gear and highest gear available. For example, press the - button twice to lock out 10th and 9th gears.

Note: The instrument cluster will indicate the current gear and highest gear available.

Press the + button to unlock gears to allow the transmission to shift to higher gears.

Note: The transmission automatically shifts within the gear range you select.

AUTOMATIC RETURN TO PARK (P)

WHAT IS AUTOMATIC RETURN TO PARK (P)

Your vehicle shifts into park (P) if you attempt to exit your vehicle without the transmission in park (P).

HOW DOES AUTOMATIC RETURN TO PARK (P) WORK

Your vehicle shifts into park (P) when your vehicle is stationary and any of the following occur:

- You switch the vehicle off.
- You open the driver door with your seatbelt unlatched.
- You unlatch the driver seatbelt when the driver door is open.

Note: Do not use automatic return to park (P) when your vehicle is moving, except in an emergency. See **Starting and Stopping the Engine** (page 231).

AUTOMATIC RETURN TO PARK (P) LIMITATIONS

Automatic return to park may not work if the door ajar switch is malfunctioning.

See an authorized dealer if any of the following occur:

Automatic Transmission

- Door ajar indicator does not illuminate with the driver door open.
- Door ajar indicator illuminates with the driver door closed.
- Transmission not in park message appears with the driver door closed, after you shift out of park (P).

Note: Do not store objects in the selector lever stow bin, and be sure that the bottom selector lever tray mat is flat inside the selector lever stow bin.

Note: If there are objects in the stow bin while stowing the selector lever, the selector lever could come back to the upright park (P) position.

STOWING THE SELECTOR LEVER

Press the stow button to fold down the selector lever. Press the button again to release the selector lever from the stow position to use.

The stow function allows the shifter to lay flat in the console, enabling the use of the working surface tray.

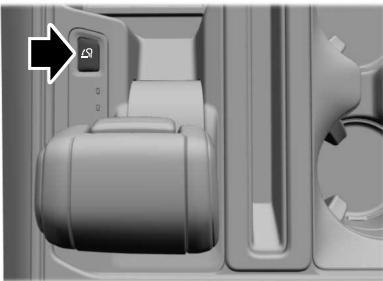

STOWING THE SELECTOR LEVER - RAPTOR

Press the stow button to fold down the selector lever. Press the button again to release the selector lever from the stow position to use.

The stow function allows the shifter to lay flat in the console, enabling the use of the working surface tray.

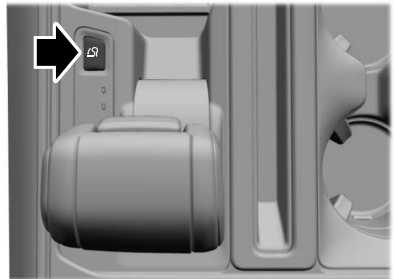

Automatic Transmission

Note: Do not store objects in the selector lever stow bin, and be sure that the bottom selector lever tray mat is flat inside the selector lever stow bin.

Note: If there are objects in the stow bin while stowing the selector lever, the selector lever could come back to the upright park (P) position.

MANUAL PARK RELEASE

WHAT IS MANUAL PARK RELEASE

Manual park release allows you to move your transmission out of the park (P) position in the event of an electrical malfunction or emergency.

MANUAL PARK RELEASE PRECAUTIONS

WARNING: When doing this procedure, you need to take the transmission out of park (P) which means your vehicle can roll freely. To avoid unwanted vehicle movement, always fully apply the parking brake prior to doing this procedure. Use wheel chocks if appropriate.

WARNING: If the parking brake is fully released, but the brake warning lamp remains illuminated, the brakes may not be working properly. Have your vehicle checked as soon as possible.

WARNING: Do not drive your vehicle until you verify that the stoplamps are working.

Use the manual park release to move your transmission from the park (P) position in the event of an electrical malfunction or emergency. See **Emergency Towing** (page 471).

Note: Do not engage the manual park release with the engine on.

USING MANUAL PARK RELEASE

Activating the Manual Park Release Cable

1. Apply the parking brake. See **Electric Parking Brake** (page 289).

Note: If vehicle battery is dead, for example, no electrical power available, an external power source may be required to apply the parking brake.

2. Locate the manual park release cable access cover at the bottom of the driver dash lower panel, under the steering wheel.

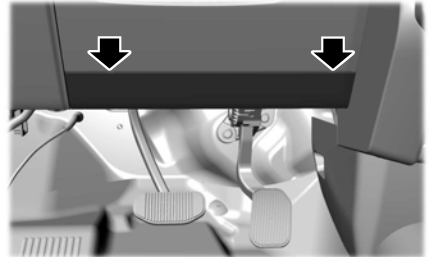

3. Carefully open the hinged access cover using a plastic type wedge or pry tool at the upper edge of the panel. If done correctly, the panel will swing downward.

Note: Do not activate the override lever until you are in the driver's seat. If damage occurs when access cover is opened, contact your authorized Ford Dealer for a replacement.

4. Switch ignition on, but do not start your vehicle.

Automatic Transmission

- Once in the driver seat, fully apply the brake pedal and hold. Do not release. Pull the tether straight out toward the driver seat until engaged. If done correctly, a message will appear in the instrument cluster.

Note: Do not use excessive force when using the manual park release handle, as it could result in damage to the handle.

Note: Your vehicle is now out of the park (P) position and is free to roll.

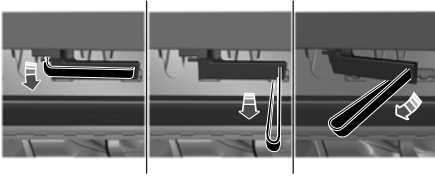

- With your foot still fully applied on the brake pedal, disengage the parking brake. See **Electric Parking Brake** (page 289).
- Your vehicle remains in neutral (N) for emergency towing purposes.
- Turn off the ignition.
- Once safe to do so, and there is no risk that your vehicle will roll, disconnect the negative (black) battery cable from the battery.

Returning Your Vehicle to Normal Mode

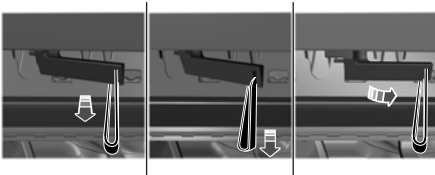

- Once it is safe to do so, reconnect the negative (black) battery cable to the battery.

- Apply the parking brake. See **Electric Parking Brake** (page 289).

Note: If vehicle battery is dead, for example, no electrical power available, an external power may be required to apply the parking brake.

Note: Do not pull the tether until you are in the driver seat.

- Once in the driver seat, fully apply the brake pedal and hold, do not release. Using the tether, pull the handle towards the driver seat until you hit a hard stop.
- Pull the lever toward the floor until it hits a hard stop, before returning to the stowed position.

Note: Maintain tension on the strap until the lever reaches the stowed position.

- Return the manual park release cable lever to the stowed position and install the access cover.
- With your foot fully applied on the brake pedal, start your vehicle. Confirm that your vehicle is in the park (P) position and that the instrument cluster indicates park (P).

Note: If the instrument cluster is not displaying the park (P) position or the instrument cluster displays an error message, apply the parking brake before exiting your vehicle.

- Close the access cover.

AUTOMATIC TRANSMISSION AUDIBLE WARNINGS

Transmission Not In Park (P) Audible Warning

Sounds if you open the driver door before shifting into park (P).

Four-Wheel Drive (If Equipped)

HOW DOES FOUR-WHEEL DRIVE WORK

Using the Electronic Shift On the Fly System (If Equipped)

This four-wheel drive system utilizes a 2-speed Electronic Shift On the Fly (ESOF) transfer case which is also known as a part-time system. This system offers the driver two-wheel drive high, four-wheel drive high, and four-wheel drive low as available modes of operation. When either four-wheel drive high or four-wheel drive low are selected, the system provides mechanically locked four-wheel drive power to both the front and rear wheels for use in off-road or slippery conditions such as deep snow, sand or mud. Selecting four-wheel drive low also provides additional gearing for increased torque multiplication for conditions like deep sand, steep slopes, or pulling heavy objects. Additionally, the system is capable of recreational flat towing by putting the transfer case into neutral (N). See **Recreationally Towing Your Vehicle** (page 469).

There is further information on driving in unique driving conditions. See **Off-Road Driving** (page 449).

Using the 2-Speed Automatic Four-Wheel Drive System (If Equipped)

The 2-speed automatic four-wheel drive system utilizes an electronically controlled on-demand 2-speed transfer case. This system monitors various vehicle sensory inputs to provide an increased level of performance. This system offers the driver two-wheel drive high, four-wheel drive auto, four-wheel drive high, and four-wheel drive low as available modes of operation. When four-wheel drive auto is selected, the system continuously varies power to the front wheels for optimum performance

for all on-road conditions. When either four-wheel drive high or four-wheel drive low are selected, the system provides electronically or mechanically locked power to the front and rear wheels for use in off-road or slippery conditions such as deep snow, sand or mud. Selecting four-wheel drive low also provides additional gearing for increased torque multiplication for conditions like deep sand, steep slopes, or pulling heavy objects. Additionally, the system is capable of recreational flat towing by putting the transfer case into neutral (N). See **Recreationally Towing Your Vehicle** (page 469).

There is further information on driving in unique driving conditions. See **Off-Road Driving** (page 449).

HOW DOES FOUR-WHEEL DRIVE WORK - RAPTOR

The 2-speed automatic four-wheel drive system utilizes an electronically controlled on-demand 2-speed transfer case. This system monitors various vehicle sensory inputs to provide an increased level of performance. This system offers the driver two-wheel drive high, four-wheel drive auto, four-wheel drive high, and four-wheel drive low as available modes of operation. When four-wheel drive auto is selected, the system continuously varies power to the front wheels for optimum performance for all on-road conditions. When either four-wheel drive high or four-wheel drive low are selected, the system provides mechanically locked power to the front and rear wheels for use in off-road or slippery conditions such as deep snow, sand or mud. Selecting four-wheel drive low also provides additional gearing for increased torque multiplication for

Four-Wheel Drive (If Equipped)

conditions like deep sand, steep slopes, or pulling heavy objects. Additionally, the system is capable of recreational flat towing by putting the transfer case into neutral (N). See **Recreationally Towing Your Vehicle** (page 469).

There is further information on driving in unique driving conditions. See **Off-Road Driving** (page 449).

FOUR-WHEEL DRIVE PRECAUTIONS



WARNING: Vehicles with a higher center of gravity (utility and four-wheel drive vehicles) handle differently than vehicles with a lower center of gravity (passenger cars). Avoid sharp turns, excessive speed and abrupt steering in these vehicles. Failure to drive cautiously increases the risk of losing control of your vehicle, vehicle rollover, personal injury and death.



WARNING: Do not become overconfident in the ability of four-wheel drive vehicles. Although a four-wheel drive vehicle may accelerate better than a two-wheel drive vehicle in low traction situations, it won't stop any faster than two-wheel drive vehicles. Always drive at a safe speed.

Truck and utility vehicles can differ from some other vehicles. Your vehicle could be higher to allow it to travel over rough terrain without getting stuck or damaging underbody components. The differences that make your vehicle so versatile also make it handle differently than an ordinary passenger car. Always maintain steering wheel control, especially in rough terrain. Since sudden changes in terrain can result in abrupt steering wheel motion, make sure you grip the steering wheel from the

outside. Do not grip the spokes. Drive cautiously to avoid vehicle damage from concealed objects such as rocks and stumps. Drive slower in strong crosswinds which can affect the normal steering characteristics of your vehicle. Be extremely careful when driving on pavement made slippery by loose sand, water, gravel, snow or ice.

Note: *Do not use four-wheel drive high or four-wheel drive low mode on dry, hard surfaced roads. Doing so can produce excessive noise, increase tire wear and can damage drive components.*

FOUR-WHEEL DRIVE LIMITATIONS

Operating Four-Wheel Drive with a Spare or Mismatched Tires (If Equipped)

On four-wheel drive vehicles, the size of the spare tire can affect the four-wheel drive system. If there is a significant difference between the size of the spare tire and the remaining tires, you could have limited four-wheel drive functionality. When driving with the full-size dissimilar spare wheel and tire assembly, we recommend that you do not:

- Exceed 50 mph (80 km/h) with a four-wheel drive mode turned on.
- Turn on a four-wheel drive mode unless the vehicle is stationary.
- Use a four-wheel drive mode on dry pavement.

Driving with the full-size dissimilar spare wheel and tire assembly can limit four-wheel drive functionality, especially when driving in a mechanically locked four-wheel drive mode. You can experience the following:

Four-Wheel Drive (If Equipped)

- Additional noise from the transfer case or other drive components.
- Difficulty shifting out of a mechanically locked four-wheel drive mode.

Use of a dissimilar spare wheel and tire assembly can lead to impairment of the following:

- Comfort and noise.
- Winter weather driving capability.
- Wet driving capability.
- Four-wheel drive capability.

Mechanical Shift Blocking

On four-wheel drive vehicles with a mechanically locked four-wheel drive high mode, the transfer case distributes torque to the front wheels by mechanically interlocking the front and rear driveshafts together. Various external factors can affect shifting performance of this type of system including, but not limited to:

- Vehicle acceleration.
- Dissimilar tire sizes.
- Steering input.

If the system detects a mechanical shift blockage at speed after you select two-wheel drive high, the message "4x4 Unable to Disengage See Manual", could display momentarily. If this message displays, one or more of the following actions can relieve the mechanical shift block:

- Momentary acceleration.
- Momentary braking.
- Bringing the vehicle to a stop.
- Shifting the transmission to neutral and back to drive.
- Shifting the transmission to reverse and back to drive.
- Driving the vehicle around a tight turn at a slow speed.

SELECTING A FOUR-WHEEL DRIVE MODE

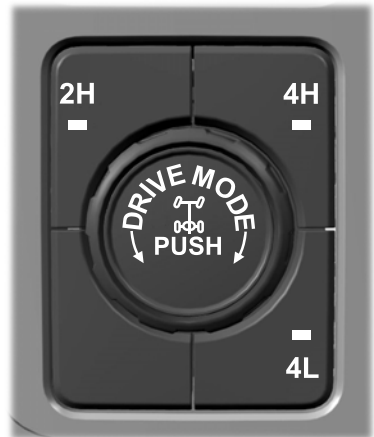

The four-wheel drive mode control is on the instrument panel.

Four-Wheel Drive (If Equipped)

To select a four-wheel drive mode, press the four-wheel drive mode control button of the desired mode. You can select two-wheel drive high (2H), four-wheel drive high (4H), or if your vehicle has four-wheel drive auto (4A) at a stop or while driving. Once the shift is complete, the information display will then display the selected four-wheel drive mode. While shifts are in progress, the lights on the four-wheel drive control switch can flash and you could see messages in the information display indicating that a shift is in progress or to release the accelerator pedal to improve shift performance.

Note: Do not perform this operation if the rear wheels are slipping or while applying the accelerator pedal.

Note: You could hear some noise as the system shifts or engages which is normal.

If the system detects a fault, a warning message appears in the information display. See **Four-Wheel Drive – Information Messages** (page 275).

Shifting to or from Four-Wheel Drive Low (4L)

To select or exit four-wheel drive low (4L):

1. Bring your vehicle to a speed of 3 mph (5 km/h) or less.
2. Place the transmission in neutral (N)
3. Press the desired four-wheel drive button on the four-wheel drive mode control switch.

The information display will display a message indicating a four-wheel drive shift is in progress. If any of the above shift conditions are not present, the shift will not occur and the information display will display information guiding the driver through the proper shifting procedures. If there is a transfer case tooth blockage a message will display in the information

display. To alleviate this condition, place the transmission in a forward gear, move your vehicle forward approximately 5 ft (1.5 m), and shift the transmission back to neutral (N) to allow the transfer case to complete the range shift.

Note: You could hear some noise as the system shifts or engages which is normal.

If the system detects a fault, a warning message appears in the information display. See **Four-Wheel Drive – Information Messages** (page 275).

SELECTING A FOUR-WHEEL DRIVE MODE - RAPTOR



The four-wheel drive mode control is on the instrument panel.

To select a four-wheel drive mode, press the four-wheel drive mode control button of the desired mode. You can select two-wheel drive high (2H), four-wheel drive high (4H), or four-wheel drive auto (4A) at a stop or while driving. Once the shift is complete, the information display

Four-Wheel Drive (If Equipped)

will then display the selected four-wheel drive mode. While shifts are in progress, the lights on the four-wheel drive control switch can flash and you could see messages in the information display indicating that a shift is in progress or to release the accelerator pedal to improve shift performance.

Note: *Do not perform this operation if the rear wheels are slipping or while applying the accelerator pedal.*

Note: *You could hear some noise as the system shifts or engages, which is normal.*

If the system detects a fault, a warning message appears in the information display. See **Four-Wheel Drive – Information Messages** (page 275).

Shifting to or from Four-Wheel Drive Low (4L)

To select or exit four-wheel drive low (4L):

1. Bring your vehicle to a speed of 3 mph (5 km/h) or less.
2. Place the transmission in neutral (N).
3. Press the desired four-wheel drive button on the four-wheel drive mode control switch.

The information display will display a message indicating a four-wheel drive shift is in progress. If any of the above shift conditions are not present, the shift does not occur and the information display will display information guiding the driver through the proper shifting procedures. If there is a transfer case tooth blockage, a message displays in the information display. To alleviate this condition, place the transmission in a forward gear, move your vehicle forward approximately 5 ft (1.5 m), and shift the transmission back to neutral (N) to allow the transfer case to complete the range shift.

Note: *You could hear some noise as the system shifts or engages, which is normal.*

If the system detects a fault, a warning message appears in the information display. See **Four-Wheel Drive – Information Messages** (page 275).

FOUR-WHEEL DRIVE MODES

TWO-WHEEL DRIVE HIGH

Two-wheel drive high is for general on-road driving. Power is sent to the rear wheels only.

Note: *Two-wheel drive high can turn on or off based on Drive Mode selection. See **Drive Mode Control** (page 350).*

FOUR-WHEEL DRIVE AUTO (If Equipped)

Four-wheel drive auto provides electronically controlled four-wheel drive power to both the front and rear wheels, as required, for increased traction in varying on-road conditions. The four-wheel drive auto tuning varies based on selected Drive Mode. See **Selecting a Drive Mode** (page 350).

Note: *Four-wheel drive auto can turn on or off automatically based on Drive Mode selection. See **Selecting a Drive Mode** (page 350).*

FOUR-WHEEL DRIVE HIGH

Four-wheel drive high provides electronically or mechanically locked four-wheel drive power to both the front and rear wheels for use in off-road or winter conditions such as deep snow, sand or mud. This mode is not for use on dry pavement.

Note: *Four-wheel drive high can turn on or off automatically based on Drive Mode selection. See **Selecting a Drive Mode** (page 350).*

Four-Wheel Drive (If Equipped)

FOUR-WHEEL DRIVE HIGH - RAPTOR

Four-wheel drive high provides mechanically locked four-wheel drive power to both the front and rear wheels for use in off-road or winter conditions such as deep snow, sand or mud. This mode is not for use on dry pavement.

Note: *Four-wheel drive high can turn on or off automatically based on Drive Mode selection. See **Selecting a Drive Mode** (page 350).*

FOUR-WHEEL DRIVE LOW

Four-wheel drive low provides electronically or mechanically locked four-wheel drive power to both the front and rear wheels for use on low traction surfaces, but does so with additional gearing for increased torque multiplication. This mode is only for off-road conditions such as deep sand, steep slopes, or pulling heavy objects.

Note: *Four-wheel drive low can turn on or off automatically based on drive mode selection. See **Selecting a Drive Mode** (page 350).*

FOUR-WHEEL DRIVE LOW - RAPTOR

Four-Wheel Drive Low provides mechanically locked four-wheel drive power to both the front and rear wheels for use on low traction surfaces, but does so with additional gearing for increased torque multiplication. The intent of this mode is only for off-road conditions such as deep sand, steep slopes, or pulling heavy objects.

Note: *Four-wheel drive low can turn on or off automatically based on drive mode selection. See **Selecting a Drive Mode** (page 350).*

FOUR-WHEEL DRIVE INDICATORS

Two-wheel Drive High

2H Momentarily illuminates when two-wheel drive high is selected.

Four-wheel Drive Auto (If Equipped)

4A Continuously illuminates when four-wheel drive auto is selected.

Four-wheel Drive High

4H Continuously illuminates when four-wheel drive high is selected.

Four-wheel Drive Low

4L Continuously illuminates when four-wheel drive low is selected.

FOUR-WHEEL DRIVE – TROUBLESHOOTING

FOUR-WHEEL DRIVE – WARNING LAMPS

 Illuminates when a four-wheel drive or power train fault is present.

Note: *When a system fault is present, the system can typically remain in whichever mode was selected prior to the fault condition occurring. It does not default to two-wheel drive in all circumstances. When this warning is displayed, have your vehicle serviced by an authorized dealer.*

Four-Wheel Drive (If Equipped)

FOUR-WHEEL DRIVE – INFORMATION MESSAGES

| Message | Action |
|-------------------------------------|--|
| Check 4x4 | A four-wheel drive system fault is present. Have your vehicle checked as soon as possible. |
| 4x4 Shift in Progress | The four-wheel drive system is making a shift. |
| For 4x4 LOW Shift to N | Displays when you attempt to switch to four-wheel drive low mode and you do not shift the transmission to neutral (N). |
| For 4x4 LOW Slow to 3 MPH | Displays when you attempt to switch to four-wheel drive low mode and your vehicle's speed is greater than 3 mph (5 km/h). |
| For 4x4 LOW Slow to 5 km/h | |
| To Exit 4x4 LOW Shift to N | Displays when you attempt to switch from four-wheel drive low mode and you do not shift the transmission to neutral (N). |
| To Exit 4x4 LOW Slow to 3 MPH | Displays when you attempt to switch from four-wheel drive low mode and your vehicle's speed is greater than 3 mph (5 km/h). |
| To Exit 4x4 LOW Slow to 5 km/h | |
| Shift Delayed Drive Forward | Displays when there is a transfer case gear tooth blockage while shifting to or from four-wheel drive low mode or to the neutral state. Place the transmission in a forward gear, move your vehicle forward approximately 5 ft (1.5 m), and shift the transmission back to neutral (N) to allow the transfer case to complete the range shift. |
| 4x4 Temporarily Disabled | Displays when the four-wheel system detects elevated system temperature and temporarily stops providing power to the front wheels. The system automatically resumes normal function when the system temperature returns to normal. |
| 4x4 Unable to Disengage. See Manual | Displays when the four-wheel drive system detects a mechanical shift block when shifting out of four-wheel drive high. See Four-Wheel Drive Limitations (page 270). |

Four-Wheel Drive (If Equipped)

| Message | Action |
|---|---|
| 4x4 Restored | Displays when the four-wheel drive system resumes normal function. |
| 4X4 Temporarily Locked | Displays when the four-wheel drive system detects driving condition which temporarily require greater four-wheel drive performance. The system automatically resumes normal function after the system no longer detects these driving conditions. |
| Shift to Neutral | Displays when the system requires an additional transmission shift to neutral (N) to complete a transfer case shift. |
| To Engage 4x4 Slow to 3 MPH | Displays when you command a four-wheel drive shift during conditions which are potentially harmful to the driveline components |
| To Engage 4x4 Slow to 5 km/h | |
| To Engage 4x4 Release Accelerator Pedal | Displays when the four-wheel drive system requests that you release the accelerator pedal to complete a four-wheel drive shift. See Selecting a Four-Wheel Drive Mode (page 271). |

Four-Wheel Drive (If Equipped)

FOUR-WHEEL DRIVE – INFORMATION MESSAGES - RAPTOR

| Message | Action |
|-------------------------------------|--|
| Check 4x4 | A four-wheel drive system fault is present. Have your vehicle checked as soon as possible. |
| 4x4 Shift in Progress | The four-wheel drive system is making a shift. |
| For 4x4 LOW Shift to N | Displays when you attempt to switch to four-wheel drive low mode and you do not shift the transmission to neutral (N). |
| For 4x4 LOW Slow to 3 MPH | Displays when you attempt to switch to four-wheel drive low mode and your vehicle's speed is greater than 3 mph (5 km/h). |
| For 4x4 LOW Slow to 5 km/h | |
| To Exit 4x4 LOW Shift to N | Displays when you attempt to switch from four-wheel drive low mode and you do not shift the transmission to neutral (N). |
| To Exit 4x4 LOW Slow to 3 MPH | Displays when you attempt to switch from four-wheel drive low mode and your vehicle's speed is greater than 3 mph (5 km/h). |
| To Exit 4x4 LOW Slow to 5 km/h | |
| Shift Delayed Drive Forward | Displays when there is a transfer case gear tooth blockage while shifting to or from four-wheel drive low mode or to the neutral state. Place the transmission in a forward gear, move your vehicle forward approximately 5 ft (1.5 m), and shift the transmission back to neutral (N) to allow the transfer case to complete the range shift. |
| 4x4 Unable to Disengage. See Manual | Displays when the four-wheel drive system detects a mechanical shift block when shifting out of four-wheel drive high. See Four-Wheel Drive Limitations (page 270). |
| 4x4 Restored | Displays when the four-wheel drive system resumes normal function. |

Four-Wheel Drive (If Equipped)

| Message | Action |
|---|--|
| 4X4 Temporarily Locked | Displays when the four-wheel drive system detects driving conditions which temporarily require greater four-wheel drive performance. The system automatically resumes normal function after the system no longer detects these driving conditions. |
| Shift to Neutral | Displays when the system requires an additional transmission shift to neutral (N) to complete a transfer case shift. |
| To Engage 4x4 Slow to 3 MPH | Displays when you command a four-wheel drive shift during conditions which are potentially harmful to the driveline components. |
| To Engage 4x4 Slow to 5 km/h | |
| To Engage 4x4 Release Accelerator Pedal | Displays when the four-wheel drive system requests that you release the accelerator pedal to complete a four-wheel drive shift. See Selecting a Four-Wheel Drive Mode (page 271). |

Electronic Locking Differential (If Equipped)

WHAT IS THE ELECTRONIC LOCKING DIFFERENTIAL

The electronic locking differential is a device housed in the rear axle, and can provide additional traction when needed.

HOW DOES THE ELECTRONIC LOCKING DIFFERENTIAL WORK

You can activate the differential electronically and shift it on the fly within the operating speed range. The electronic differential disengages when the vehicle speed exceeds a set value, and reengages when the vehicle speed goes below a set value. See **Switching the Electronic Locking Differential On and Off** (page 280). It also engages based on certain selected drive modes. See **Selecting a Drive Mode** (page 350). The electronic locking differential is for use in mud, rocks, sand, or any off-road condition where you need maximum traction.

Note: *The electronic locking differential can activate or deactivate automatically based on speed, four-wheel drive mode, and drive mode selection. See **Switching the Electronic Locking Differential On and Off** (page 280).*

Note: *The electronic locking differential is for off-road use only and is not for use on dry pavement. Using the electronic locking differential on dry pavement results in increased tire wear, noise and vibration.*

HOW DOES THE ELECTRONIC LOCKING DIFFERENTIAL WORK - RAPTOR

You can activate the differential electronically and shift it on the fly within the operating speed range. The electronic differential disengages when the vehicle speed exceeds a set value and it reengages when the vehicle speed goes below a set value depending on drive mode. See **Switching the Electronic Locking Differential On and Off** (page 280). The electronic locking differential is for use in mud, rocks, sand, or any off-road condition where you need maximum traction.

Note: *The electronic locking differential can activate or deactivate automatically based on speed, four-wheel drive mode, and drive mode selection. See **Switching the Electronic Locking Differential On and Off** (page 280).*

Note: *The electronic locking differential is for off-road use only and is not for use on dry pavement. Using the electronic locking differential on dry pavement results in increased tire wear, noise and vibration.*

Note: *The electronic locking differential is not available in 2H.*

ELECTRONIC LOCKING DIFFERENTIAL PRECAUTIONS

Operating the Electronic Locking Differential with a Spare or Mismatched Tires

On vehicles with an electronic locking differential, the size of the spare tire can affect performance of the system. If there is a significant difference between the two rear tires, you may have limited electronic locking differential functionality. If the system has difficulty disengaging, release

Electronic Locking Differential (If Equipped)

the accelerator pedal and turn the steering wheel in the opposite direction when rolling. We recommend engaging and disengaging the electronic locking differential at a stop when you mount a spare on the rear axle.

SWITCHING THE ELECTRONIC LOCKING DIFFERENTIAL ON AND OFF - 4X4

The button to activate and deactivate the electronic locking differential is in the center of the drive mode rotary switch.



To manually activate or deactivate the electronic locking differential, press the electronic locking differential button.

Note: The electronic locking differential can activate or deactivate automatically based on speed, four-wheel drive mode, and drive mode selection. See **Selecting a Drive Mode** (page 350).

4X4 Rear Electronic Locking Differential Engagement Speed and Availability

| Drive Modes | Maximum Engagement Speed | Automatic Disengagement Speed | Automatic Re-engagement Speed |
|-----------------------------------|--------------------------|-------------------------------|-------------------------------|
| Normal (2H, 4A ² , 4H) | 20 mph (30 km/h) | 25 mph (41 km/h) | 20 mph (30 km/h) |
| Eco (2H, 4A ³ , 4H) | 20 mph (30 km/h) | 25 mph (41 km/h) | 20 mph (30 km/h) |
| Sport (2H, 4A ² , 4H) | 20 mph (30 km/h) | 25 mph (41 km/h) | 20 mph (30 km/h) |

Electronic Locking Differential (If Equipped)

| Drive Modes | Maximum Engagement Speed | Automatic Disengagement Speed | Automatic Re-Engagement Speed |
|--------------------------------------|--------------------------|-------------------------------|-------------------------------|
| Slippery (2H, 4A ² , 4H) | 20 mph (30 km/h) | 25 mph (41 km/h) | 20 mph (30 km/h) |
| Deep Snow/Sand (4H, 4L) ¹ | No Speed Limit | No Speed Limit | No Speed Limit |
| Mud/Ruts (4H, 4L) ¹ | No Speed Limit | No Speed Limit | No Speed Limit |
| Rock Crawl (4L) ¹ | No Speed Limit | No Speed Limit | No Speed Limit |
| Tow/Haul Mode | No Speed Limit | 25 mph (41 km/h) | 20 mph (30 km/h) |

¹Automatically engages when you select these drive modes. You have the ability to manually override the automatic engagement by pressing the electronic locking differential button.

²If available for 4A drive modes.

| 4WD Mode | Maximum Engagement Speed | Automatic Disengagement Speed | Automatic Re-Engagement Speed |
|---------------------------|--------------------------|-------------------------------|-------------------------------|
| Four-Wheel Drive Low (4L) | No speed Limit | No speed Limit | No speed Limit |

Note: The electronic locking differential may not engage if you press your accelerator pedal during an engagement attempt. A message could display in the instrument display guiding you to release the accelerator pedal.

Note: If the electronic locking differential has difficulty disengaging, release the accelerator pedal and turn the steering wheel in the opposite direction while rolling.

Note: The electronic locking differential is for off-road use only and is not for use on dry pavement. Using the electronic locking differential on dry pavement results in increased tire wear, noise and vibration.

SWITCHING THE ELECTRONIC LOCKING DIFFERENTIAL ON AND OFF - RAPTOR

The button to activate and deactivate the electronic locking differential is in the center of the drive mode rotary switch.

Electronic Locking Differential (If Equipped)



To manually activate or deactivate the electronic locking differential, press the electronic locking differential button.

Note: The electronic locking differential can activate or deactivate automatically based on speed, four-wheel drive mode, and drive mode selection. See **Selecting a Drive Mode** (page 350).

Rear Electronic Locking Differential Engagement Speed and Availability

| Drive Modes | Maximum Engagement Speed | Automatic Disengagement Speed | Automatic Re-Engagement Speed |
|------------------------------|--------------------------|-------------------------------|-------------------------------|
| Normal (4A, 4H) | 20 mph (30 km/h) | 25 mph (41 km/h) | 20 mph (30 km/h) |
| Sport (4A, 4H) | 20 mph (30 km/h) | 25 mph (41 km/h) | 20 mph (30 km/h) |
| Slippery (4A, 4H) | 20 mph (30 km/h) | 25 mph (41 km/h) | 20 mph (30 km/h) |
| Tow/Haul (4A,4H) | 20 mph (30 km/h) | 25 mph (41 km/h) | 20 mph (30 km/h) |
| Off-Road (4H) ¹ | No Speed Limit | No Speed Limit | No Speed Limit |
| Baja (4H) | No Speed Limit | No Speed Limit | No Speed Limit |
| Rock Crawl (4L) ¹ | No Speed Limit | No Speed Limit | No Speed Limit |

¹Automatically engages when you select this drive mode. You have the ability to manually override the automatic engagement by pressing the electronic locking differential button.

| 4WD Mode | Maximum Engagement Speed | Automatic Disengagement Speed | Automatic Re-Engagement Speed |
|---------------------------|--------------------------|-------------------------------|-------------------------------|
| Four-Wheel Drive Low (4L) | No speed Limit | No speed Limit | No speed Limit |

Electronic Locking Differential (If Equipped)

Note: The electronic locking differential may not engage if you press your accelerator pedal during an engagement attempt. A message could display in the instrument display guiding you to release the accelerator pedal.

Note: If the electronic locking differential has difficulty disengaging, release the accelerator pedal and turn the steering wheel in the opposite direction while rolling.

Note: The electronic locking differential is for off-road use only and is not for use on dry pavement. Using the electronic locking differential on dry pavement results in increased tire wear, noise and vibration.

SWITCHING THE ELECTRONIC LOCKING DIFFERENTIAL ON AND OFF - 4X2

The button to activate and deactivate the electronic locking differential is located in the center of the Drive mode rotary switch.



To manually activate or deactivate the electronic locking differential, press the electronic locking differential button.

4X2 Rear Electronic Locking Differential Engagement Speed and Availability

| Maximum Engagement Speed | Automatic Disengagement Speed | Automatic Re-Engagement Speed |
|--------------------------|-------------------------------|-------------------------------|
| 20 mph (30 km/h) | 25 mph (41 km/h) | 20 mph (30 km/h) |

Note: The electronic locking differential may not engage if you press your accelerator pedal during an engagement attempt. A message could display in the instrument display guiding you to release the accelerator pedal.

Note: If the electronic locking differential has difficulty disengaging, release the accelerator pedal and turn the steering wheel in the opposite direction while rolling.

Note: The electronic locking differential is for off-road use only and is not for use on dry pavement. Using the electronic locking differential on dry pavement results in increased tire wear, noise and vibration.

ELECTRONIC LOCKING DIFFERENTIAL INDICATORS



If both rear wheel axle shafts lock together, the indicator in the cluster is amber, providing additional traction.

Electronic Locking Differential (If Equipped)

If you select the electronic locking differential and the indicator in the cluster is gray or turns from amber to gray while driving, one of the following has occurred:

- The vehicle speed is too high.
- The accelerator pedal is too high during an engagement attempt.
- The vehicle is experiencing an anti-lock brake activation.
- The left and right wheel speed difference is too high during an engagement attempt.

If you select the electronic locking differential and the indicator in the cluster does not turn on, the following has occurred:

- The system has malfunctioned and accompanies a check locking differential message in the information display. See your dealer as soon as possible.

Note: *If the vehicle is experiencing an anti-lock braking event, the electronic locking differential could momentarily disengage.*

ELECTRONIC LOCKING DIFFERENTIAL – TROUBLESHOOTING

ELECTRONIC LOCKING DIFFERENTIAL – INFORMATION MESSAGES

| Message | Description and Action |
|--|---|
| To Engage Locking Differential Slow to XX mph/km/h | The electronic locking differential has been requested and will engage when the speed condition is met. |
| To Engage Locking Differential Release Accelerator Pedal | Release the accelerator pedal in order to engage. |
| Check Locking Differential | An electronic locking differential system fault is present. Contact an authorized dealer as soon as possible. |

Electronic Locking Differential (If Equipped)

ELECTRONIC LOCKING DIFFERENTIAL – INFORMATION MESSAGES - RAPTOR

| Message | Description and Action |
|--|---|
| To Engage Locking Differential Slow to XX mph/km/h | The electronic locking differential has been requested and will engage when the speed condition is met. |
| To Engage Locking Differential Release Accelerator Pedal | Release the accelerator pedal in order to engage. |
| Check Locking Differential | An electronic locking differential system fault is present. Contact an authorized dealer as soon as possible. |
| Locking differential not available in 2H | Displays when the electronic locking differential is selected while in 2H. |

Brakes

BRAKE PRECAUTIONS



WARNING: Driving your vehicle with the warning lamp on is dangerous. A significant decrease in braking performance may occur. It may take you longer to stop your vehicle. Have your vehicle checked as soon as possible. Driving extended distances with the parking brake engaged can cause brake failure and the risk of personal injury.

Wet brakes result in reduced braking efficiency. Gently press the brake pedal a few times when leaving a car wash or driving from standing water to dry the brakes.

Note: *Depending on applicable laws and regulations in the country for which your vehicle was originally built, the stoplamps could flash during heavy braking. Following this the hazard warning flashers could also turn on when your vehicle comes to a stop.*

ANTI-LOCK BRAKING SYSTEM

ANTI-LOCK BRAKING SYSTEM LIMITATIONS

The anti-lock braking system does not eliminate the risk of crash when:

- You drive too closely to the vehicle in front of you.
- Your vehicle is hydroplaning.
- You take corners too fast.
- The road surface is poor.

Note: *If the system activates, the brake pedal could pulse and travel further. Maintain pressure on the brake pedal.*

BRAKE OVER ACCELERATOR

In the event the accelerator pedal becomes stuck or entrapped, apply steady and firm pressure to the brake pedal to slow the vehicle and reduce engine power. If you experience this condition, apply the brakes and bring your vehicle to a safe stop. Move the transmission to park (P), switch the engine off and apply the parking brake. Inspect the accelerator pedal for any interference. If none are found and the condition persists, have your vehicle towed to the nearest authorized dealer.

BRAKE OVER ACCELERATOR - RAPTOR

In the event the accelerator pedal becomes stuck or entrapped, apply steady and firm pressure to the brake pedal to slow the vehicle and reduce engine power. If you experience this condition, apply the brakes and bring your vehicle to a safe stop. Move the transmission to park (P), switch the engine off and apply the parking brake. Inspect the accelerator pedal for any interference. If none are found and the condition persists, have your vehicle towed to the nearest authorized dealer.

Note: *Certain drive modes can disable brake over accelerator for off-road driving.*

LOCATING THE BRAKE FLUID RESERVOIR

See **Under Hood Overview** (page 483).

Brakes

CHECKING THE BRAKE FLUID

WARNING: Do not use any fluid other than the recommended brake fluid as this will reduce brake efficiency. Use of incorrect fluid could result in the loss of vehicle control, serious personal injury or death.

WARNING: Only use brake fluid from a sealed container. Contamination with dirt, water, petroleum products or other materials may result in brake system damage or failure. Failure to adhere to this warning could result in the loss of vehicle control, serious personal injury or death.

WARNING: Do not allow the fluid to touch your skin or eyes. If this happens, rinse the affected areas immediately with plenty of water and contact your physician.

WARNING: The brake system could be affected if the brake fluid level is below the **MIN** mark or above the **MAX** mark on the brake fluid reservoir.



1. Park your vehicle on a level surface.
2. Look at the brake fluid reservoir to see where the brake fluid level is relative to the **MIN** and the **MAX** marks on the reservoir.

Note: To avoid fluid contamination, the reservoir cap must remain in place and fully tight, unless you are adding fluid.

Only use fluid that meets our specifications. See **Capacities and Specifications** (page 558).

BRAKE FLUID SPECIFICATION

See **Brake Fluid Specification** (page 590).

Brakes

BRAKES – TROUBLESHOOTING

BRAKES – WARNING LAMPS



If the ABS indicator illuminates when you are driving, this indicates a malfunction. Your vehicle continues to have normal braking without the anti-lock braking system function. See an authorized dealer.

It also momentarily illuminates when you switch the ignition on to confirm the lamp is functional. If it does not illuminate when you switch the ignition on, or begins to flash at any time, have the system checked by an authorized dealer.



The brake indicator momentarily illuminates when you switch the ignition on to confirm the lamp is functional. It may also illuminate when you apply the parking brake and the ignition is on. If it illuminates when your vehicle is moving, make sure the parking brake is disengaged. If the parking brake is disengaged, this indicates low brake fluid level or a brake system fault. See an authorized dealer.

BRAKES – FREQUENTLY ASKED QUESTIONS

Is it normal for my brakes to make noise?

Occasional brake noise is normal. If a metal-to-metal, continuous grinding, or continuous squeal sound is present, the brake lining could be worn-out. Have the system checked by an authorized dealer.

There is an electrical motor sound when I press on the brake pedal or activate the park brake switch. Is this normal?

Yes, those sounds are the electronic brake booster or the electronic park brake operating.

Note: *Brake dust could accumulate on the wheels, even under normal driving conditions. Some dust is normal as the brakes wear and does not contribute to brake noise. See **Cleaning Wheels** (page 512).*

Electric Parking Brake

WHAT IS THE ELECTRIC PARKING BRAKE

The electric parking brake is used to hold your vehicle on slopes and flat roads.

APPLYING THE ELECTRIC PARKING BRAKE



WARNING: Always fully apply the parking brake and make sure you shift into park (P). Failure to follow this instruction could result in personal injury or death.



WARNING: If you drive extended distances with the parking brake applied, you could cause damage to the brake system.



The switch is on the lower part of the instrument panel.

1. Pull the switch up.

The red warning lamp flashes during operation and illuminates when the parking brake is applied.

Note: You can apply the electric parking brake when the ignition is off.

Note: The electric parking brake could apply when the transmission selector is in park (P). See **Park (P)** (page 260).

APPLYING THE ELECTRIC PARKING BRAKE IN AN EMERGENCY

You can use the electric parking brake to slow or stop your vehicle in an emergency.

1. Pull the switch up and hold it.

The electric parking brake continues to slow your vehicle down unless you release the switch.

The red warning lamp illuminates, a tone sounds and the stoplamps turn on when you use the electric parking brake in an emergency.

Note: Do not apply the electric parking brake when your vehicle is moving, except in an emergency. If you repeatedly use the electric parking brake to slow or stop your vehicle, you could cause damage to the brake system.

MANUALLY RELEASING THE ELECTRIC PARKING BRAKE

1. Switch the ignition on.
2. Press and hold the brake pedal.
3. Push the switch down.

The red warning lamp turns off.

Pulling Away on a Hill When Towing a Trailer

1. Press and hold the brake pedal.
2. Pull the switch upward and hold it.
3. Shift into gear.
4. Press the accelerator pedal until engine has developed sufficient torque to prevent your vehicle from rolling down the hill.
5. Release the switch and pull away in a normal manner.

AUTOMATICALLY RELEASING THE ELECTRIC PARKING BRAKE

1. Close the driver door.
2. Shift into gear.

Electric Parking Brake

3. Press the accelerator pedal and pull away in a normal manner.

ELECTRIC PARKING BRAKE AUDIBLE WARNING

Sounds when the parking brake is on and your vehicle is moving. If the warning tone continues after you have released the parking brake, this indicates a malfunction. Have your vehicle checked as soon as possible.

RELEASING THE ELECTRIC PARKING BRAKE IF THE VEHICLE BATTERY HAS RUN OUT OF CHARGE



WARNING: The electric parking brake does not operate if the vehicle battery has run out of charge.

Connect a booster battery to the vehicle battery to release the electric parking brake if the vehicle battery has run out of charge. See **Jump Starting the Vehicle** (page 465).

ELECTRIC PARKING BRAKE – TROUBLESHOOTING

ELECTRIC PARKING BRAKE – WARNING LAMPS

Brake System



It illuminates red when you apply the parking brake and your vehicle is on. If the lamp flashes when the parking brake has been released, this indicates the parking brake system requires service. Have your vehicle checked as soon as possible.

Note: Lamps may vary depending on region.

Electric Parking Brake



When the lamp illuminates yellow, it indicates a malfunction in the electric parking brake. Have your vehicle checked as soon as possible.

Electric Parking Brake

ELECTRIC PARKING BRAKE – INFORMATION MESSAGES

| Message | Action |
|--|--|
| To Release: Press Brake and Switch | The electric parking brake is set and a manual release is attempted without the brake pedal being pressed. |
| Park Brake Use Switch to Release | The electric parking brake is set and an automatic release is attempted but cannot be performed. Perform a manual release. |
| Release Park Brake | The electric parking brake is set and your vehicle speed exceeds 3 mph (5 km/h). Release the parking brake before continuing driving. |
| Park Brake Not Applied | The electric parking brake is not fully applied. |
| Park Brake Not Released | The electric parking brake is not fully released. |
| Park Brake Maintenance Mode | The electric parking brake system has been put into a special mode that is used to allow service of the rear brakes. Contact an authorized dealer. |
| Park Brake Limited Function Service Required | The electric parking brake system has detected a condition that requires service. Some functionality may still be available. Contact an authorized dealer. |
| Park Brake Malfunction Service Now | The electric parking brake system has detected a condition that requires service. Contact an authorized dealer. |

Reverse Braking Assist (If Equipped)

WHAT IS REVERSE BRAKING ASSIST

The system uses sensors on the rear of your vehicle to detect a possible collision and applies the brakes to either reduce the damage from impact, or to assist in avoiding the collision.

HOW DOES REVERSE BRAKING ASSIST WORK

Reverse Braking Assist functions when in reverse (R) and traveling at a speed of 1–7 mph (1.5–12 km/h).

If the system detects an obstacle behind your vehicle, it provides a warning through the rear parking aid or cross traffic alert system.

REVERSE BRAKING ASSIST PRECAUTIONS

 **WARNING:** You are responsible for controlling your vehicle at all times. The system is designed to be an aid and does not relieve you of your responsibility to drive with due care and attention. Failure to follow this instruction could result in the loss of control of your vehicle, personal injury or death.

 **WARNING:** To help avoid personal injury, always use caution when in reverse (R) and when using the sensing system.

 **WARNING:** The system may not operate properly during severe weather conditions, for example snow, ice, heavy rain and spray. Always drive with due care and attention. Failure to take care may result in a crash.

 **WARNING:** Traffic control systems, fluorescent lamps, inclement weather, air brakes, external motors and fans may affect the correct operation of the sensing system. This may cause reduced performance or false alerts.

 **WARNING:** Some situations and objects prevent hazard detection. For example low or direct sunlight, inclement weather, unconventional vehicle types, and pedestrians. Apply the brakes when necessary. Failure to follow this instruction could result in the loss of control of your vehicle, personal injury or death.

 **WARNING:** Do not use the system with accessories that extend beyond the front or rear of your vehicle, for example a trailer hitch or bike rack. The system is not able to make corrections for the additional length of the accessories.

The system only applies the brakes for a short period of time when an event occurs. Act as soon as you notice the brakes apply in order to remain in control of the vehicle. If you do not intervene the vehicle may start to move again.

Note: *Certain add-on devices around the bumper or fascia may create false alerts. For example, large trailer hitches, bicycle or surfboard racks, license plate brackets, bumper covers or any other device that may block the normal detection zone of the system. Remove the add-on device to prevent false alerts.*

Note: *The system does not react to small or moving objects, particularly those close to the ground.*

Note: *The system does not operate during hard acceleration or steering.*

Reverse Braking Assist (If Equipped)

Note: If your vehicle sustains damage to the bumper or fascia leaving it misaligned or bent, it could alter the sensing zone causing inaccurate measurement of obstacles or false alerts.

Note: Vehicle loading and suspension changes can impact the angle of the sensors and may change the normal detection zone of the system resulting in inaccurate measurement of obstacles or false alerts.

Note: When you connect a trailer, the system may detect the trailer and provide an alert, or the system turns off. If the system does not turn off, switch the system off manually after you connect the trailer.

Note: You may experience reduced system performance on road surfaces that limit deceleration. For example, roads with ice, loose gravel, mud or sand.

SWITCHING REVERSE BRAKING ASSIST ON AND OFF

1. Press **Features** on the touchscreen.
2. Press **Driver Assistance**.
3. Switch **Reverse Brake Assist** on or off.

Note: The system is unavailable when the rear parking aid, cross traffic alert or traction control is off.

Note: If your vehicle is not equipped with cross traffic alert the reverse braking assist relies on input from the rear parking aid and rear camera sensors.

Note: The default setting is on in some regions.

OVERRIDING REVERSE BRAKING ASSIST

There could be instances when unexpected or unwanted braking occurs. Firmly pressing the accelerator pedal or switching the feature off overrides the system.

REVERSE BRAKING ASSIST INDICATORS

If the system determines that a collision with an obstacle may occur, full braking may apply. Bring your vehicle to a stop a safe distance away from the obstacle.



A message and warning indicator appear when the system applies the brakes.

Reverse Braking Assist (If Equipped)

REVERSE BRAKING ASSIST – TROUBLESHOOTING

REVERSE BRAKING ASSIST – INFORMATION MESSAGES

| Message | Action |
|---|---|
| Reverse Brake Assist Not Available See Manual | Make sure that all doors, liftgate and hood are closed. Drive the vehicle on a straight road for a short period. Make sure the parking aids and cross traffic alert systems are on. If the message remains on, have the system checked as soon as possible. |
| Reverse Brake Assist Fault | Displays when a system error has occurred. Have your vehicle checked as soon as possible. |
| Reverse Brake Assist Off | Displays when reverse brake assist is off. |

Reverse Braking Assist (If Equipped)

REVERSE BRAKING ASSIST – FREQUENTLY ASKED QUESTIONS

Why is reverse braking assist unavailable?

- Make sure the reverse braking assist is on. See **Switching Reverse Braking Assist On and Off** (page 293).
- Make sure that all doors and the liftgate or tailgate are closed. Drive the vehicle on a straight road for a short period. If the message remains, contact an authorized dealer.
- Make sure the cross traffic alert system is on if equipped. See **Switching Reverse Braking Assist On and Off** (page 293).
- Make sure the rear parking aid system is on. See **Rear Parking Aid** (page 314).
- Make sure the traction control is on. See **Switching Reverse Braking Assist On and Off** (page 293).

Note: *The traction control automatically turns off if four-wheel drive low and certain drive modes such as mud/ruts and snow/sand is activated.*

- The vehicle may have sustained a rear end impact. Contact an authorized dealer to have the sensors checked for proper coverage and operation.
- An anti-lock brake, traction control or stability control event may have occurred. Reverse braking assist resumes operation when the event is complete.
- Make sure the rear view camera and 360 degree camera are not dirty or obstructed. If dirty, clean the camera. If the message still appears after cleaning the camera, wait a short time for the message to clear. If the message does not clear, contact an authorized dealer.

- Make sure the cross traffic alert and rear parking aid sensors are not blocked or faulty. See **Locating the Cross Traffic Alert Sensors** (page 373). See **Locating the Rear Parking Aid Sensors** (page 314).
- You recently had your vehicle serviced, or the battery disconnected. Drive your vehicle a short distance to resume system operation.
- Reverse braking assist does not function when you connect a trailer. Operation resumes when you disconnect the trailer.

Note: *If the answers to why the system is unavailable do not assist in returning reverse braking assist to available, have the system checked as soon as possible.*

Hill Start Assist

WHAT IS HILL START ASSIST

Hill Start Assist makes it easier for you to pull away when your vehicle is on a slope without using the parking brake.

HOW DOES HILL START ASSIST WORK

When the system activates, your vehicle remains stationary for a few seconds after you release the brake pedal. This gives you time to move your foot from the brake pedal to the accelerator pedal. The brakes release when the engine has developed sufficient torque to prevent your vehicle from rolling down the slope.

HILL START ASSIST PRECAUTIONS



WARNING: The system does not replace the parking brake. When you leave your vehicle, always apply the parking brake.



WARNING: You must remain in your vehicle when the system turns on. At all times, you are responsible for controlling your vehicle, supervising the system and intervening, if required. Failure to take care may result in the loss of control of your vehicle, serious personal injury or death.



WARNING: The system will turn off if a malfunction is apparent. Failure to take care may result in the loss of control of your vehicle, serious personal injury or death.

HILL START ASSIST – TROUBLESHOOTING

HILL START ASSIST – INFORMATION MESSAGES

| Message | Action |
|---------------------------------|---|
| Hill Start Assist Not Available | Displays when system is not available. Have your vehicle checked as soon as possible. |

Auto Hold

HOW DOES AUTO HOLD WORK

Auto Hold applies the brakes to hold your vehicle after you stop it and release the brake pedal. This can help when waiting on a hill or in traffic.

SWITCHING AUTO HOLD ON AND OFF



WARNING: The system does not replace the parking brake. When you leave your vehicle, always apply the parking brake.



WARNING: You must remain in your vehicle when the system turns on. At all times, you are responsible for controlling your vehicle, supervising the system and intervening, if required. Failure to take care may result in the loss of control of your vehicle, serious personal injury or death.

You can switch the system on or off by accessing the menu on the touchscreen.

1. Press **Settings** on the touchscreen.
2. Press **Driver Assistance**.

Note: You can only switch the system on after you close the driver door and fasten your seatbelt.

Note: The system remembers the last setting when you start your vehicle.

Note: When using an automatic car wash, make sure to switch auto hold off, or shift to neutral (N) with the brake pedal applied to ensure auto hold is not active.

USING AUTO HOLD

1. Bring your vehicle to a complete stop. The auto hold active indicator illuminates in the information display.
2. Release the brake pedal. The system holds your vehicle at a standstill. The auto hold active indicator remains illuminated in the information display.
3. Pull away in the normal manner. The system releases the brakes and the auto hold active indicator switches off.

Note: The system only activates if you apply enough brake pressure on the brake pedal to bring the vehicle to a standstill.

Note: Under certain conditions, the system could apply the electric parking brake. The brake system warning lamp illuminates. The electric parking brake releases when you press the accelerator pedal. See **Automatically Releasing the Electric Parking Brake** (page 289).

Note: Auto hold cancels if you shift into reverse (R), or neutral (N), and press the brake pedal.

There could be actions that can cause the auto hold system not to work when the following occur:

- When you use active park assist.
- The driver door is open.
- You have not fastened your seatbelt.
- You shift into reverse (R), or neutral (N) before the system is active.

AUTO HOLD INDICATORS



Illuminates when the system is active.



Illuminates when the system is on but cannot hold your vehicle at a standstill at this particular time.

Traction Control

WHAT IS TRACTION CONTROL

The traction control system helps to avoid drive wheel spin and loss of traction.

HOW DOES TRACTION CONTROL WORK

If your wheels begin to spin, the loss of traction can compromise steering control and stability of the vehicle. The traction control system applies the brakes to individual wheels and when needed, reduces engine power at the same time to increase traction.

SWITCHING TRACTION CONTROL ON AND OFF



WARNING: Operating your vehicle with the traction control disabled could lead to an increased risk of loss of vehicle control, vehicle rollover, personal injury and death.



The traction control system turns on each time you switch the ignition on.

The button for the stability and traction control system is on the instrument panel.

Press and release the button to switch traction control off. The stability control system remains fully active, to switch it off, press and hold the button for a few seconds, then release.

When you switch traction control off, a message and an illuminated icon appear on the instrument cluster.

Press the switch again to turn the traction control system back on to normal operation.

If your vehicle is stuck in mud or snow, switching traction control off may be beneficial as this allows the wheels to spin.

Your vehicle may have MyKey restrictions regarding this feature. See **What Is MyKey** (page 96).

TRACTION CONTROL INDICATOR

Stability and Traction Control Indicator



If the indicator does not illuminate when you switch the ignition on, or remains on when the engine is running, this indicates a malfunction. Have your vehicle checked by an authorized dealer as soon as possible.



The traction control off indicator illuminates when you switch the traction control system off, or when an alternative stability control mode is selected that requires the traction control off depending on the drive mode selected.

Traction Control

TRACTION CONTROL – TROUBLESHOOTING

TRACTION CONTROL – INFORMATION MESSAGES

| Message | Action |
|----------------------|---|
| Service AdvanceTrac | The system detects a condition that requires service. Contact an authorized dealer as soon as possible. |
| AdvanceTrac Off | The status of the AdvanceTrac system after you switched it off. |
| AdvanceTrac On | The status of the AdvanceTrac system after you switched it on. |
| Traction Control Off | The status of the traction control system after you switched it off. |
| Traction Control On | The status of the traction control system after you switched it on. |

Stability Control

HOW DOES STABILITY CONTROL WORK



WARNING: Vehicle modifications involving braking system, aftermarket roof racks, suspension, steering system, tire construction and wheel and tire size may change the handling characteristics of your vehicle and may adversely affect the performance of the electronic stability control system. In addition, installing any stereo speakers may interfere with and adversely affect the electronic stability control system. Reducing the effectiveness of the electronic stability control system could lead to an increased risk of loss of vehicle control, vehicle rollover, personal injury and death.



WARNING: Remember that even advanced technology cannot defy the laws of physics. It's always possible to lose control of a vehicle due to inappropriate driver input for the conditions. Aggressive driving on any road condition can cause you to lose control of your vehicle increasing the risk of personal injury or property damage. Activation of the electronic stability control system is an indication that at least some of the tires have exceeded their ability to grip the road; this could reduce the operator's ability to control the vehicle potentially resulting in a loss of vehicle control, vehicle rollover, personal injury and death.



WARNING: You are responsible for controlling your vehicle at all times. The system is designed to be an aid and does not relieve you of your responsibility to drive with due care and attention. Failure to follow this instruction could result in the loss of control of your vehicle, personal injury or death.

If a driving condition activates either the stability control or traction control you may experience the following conditions:

- The stability and traction control light flashes.
- Your vehicle slows down.
- Reduced engine power.

The stability control system has several features built into it to help you maintain control of your vehicle:

Electronic Stability Control

Electronic stability control enhances your vehicle's ability to prevent skids or lateral slides by applying brakes to one or more of the wheels individually and, if necessary, reducing engine power.

Roll Stability Control

Roll stability control enhances your vehicle's ability to prevent rollovers by detecting your vehicle's roll motion and the rate at which it changes by applying the brakes to one or more wheels individually.

Curve Control

Curve control enhances your vehicle's ability to follow the road when cornering severely or avoiding objects in the roadway. Curve control operates by reducing engine power and, if necessary, applying brakes to one or more of the wheels individually.

Stability Control

Side Wind Stabilization

Side wind stabilization is an advanced feature that works by carefully applying the brakes on one side of the vehicle to reduce the effect of a side wind gust on the vehicle's path.

Torque Vectoring by Brakes

Torque vectoring control applies brake torque on the inner driven wheel in a curve for better traction to avoid an understeer, or oversteer situation. Unlike electronic stability control, enhanced torque vectoring control does not slow the vehicle. It helps control excessive wheel slip and gives the vehicle improved cornering agility.

Traction Control

Traction control enhances your vehicle's ability to maintain traction of the wheels by detecting and controlling wheel spin. See **What Is Traction Control** (page 298).

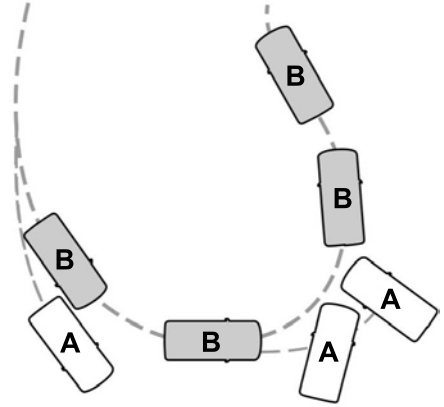

- A Vehicle without stability control skidding off its intended route.
- B Vehicle with stability control maintaining control on a slippery surface.

SWITCHING STABILITY CONTROL ON AND OFF

Stability Control turns on each time you switch the ignition on.

You can switch the stability control off by pressing and holding the stability and traction control button off for 5-15 seconds, or you can press the button again to switch the system on.

Shifting the transmission into reverse (R) will disable the system.

You can switch the traction control system off or on independently. See **Switching Traction Control On and Off** (page 298).

Stability Control

Stability Control and Traction Control with Roll Stability Control

| | Stability Control OFF Light | Roll Stability Control³ | Electronic Stability Control³ | Traction Control System³ |
|---|------------------------------------|---|---|--|
| Default at start-up | Illuminated during bulb check | Enabled | Enabled ³ | Enabled |
| Button pressed momentarily | Illuminated | Enabled | Enabled ³ | Disabled ¹ |
| Button pressed and held for 5 - 15 seconds | Illuminated | Enabled | Disabled ² | Disabled ¹ |
| Button not pressed and transfer case is switched to 4x4 Low or put into Rock Crawl Mode | Illuminated | Disabled | Disabled | Disabled ¹ |

¹ The Traction Control system can still be enabled but with tighter or looser thresholds.

² When you press and hold the button, a progress bar will display to show the button hold time progress.

³ Functions can vary depending on what selectable drive mode the vehicle is currently in.

STABILITY CONTROL INDICATOR

Stability and Traction Control Indicator



If the indicator does not illuminate when you switch the power on, or remains on, this indicates a malfunction. Have your vehicle checked by an authorized dealer as soon as possible.

Trail Control

WHAT IS TRAIL CONTROL - RAPTOR



WARNING: The system does not control speed in low traction conditions or extremely steep slopes. The system is designed to be an aid and does not relieve you of your responsibility to drive with due care and attention. Failure to follow this instruction could result in personal injury.

Trail control lets you focus on steering during low-speed and off-road use by controlling your vehicle's acceleration and braking to maintain the speed that you set.

You may hear a noise from the anti-lock brake system pump motor when you use the system. This is normal.

TRAIL CONTROL LIMITATIONS - RAPTOR

Trail control is unavailable when any of the following occur:

- Your vehicle speed is greater than 20 mph (32 km/h) in two-wheel drive high (2H) or four-wheel drive high (4H) modes.
- Your vehicle speed is greater than 9 mph (15 km/h) in four-wheel drive low (4L) mode.
- Your vehicle speed is greater than 5 mph (8 km/h) in reverse (R).
- The transmission is in park (P).
- The driver side door is open or your seatbelt is off when the driver side door is removed.
- Cruise control is on.
- Pro trailer backup assist is on.

SWITCHING TRAIL CONTROL ON AND OFF - RAPTOR



Press the button.

The system switches off if you press the button again or exceed 40 mph (64 km/h).

SETTING THE TRAIL CONTROL SPEED - RAPTOR

Note: *The buttons are located on the steering wheel.*

Drive to your preferred speed.



Press button to increase the set current speed.



Press button to decrease the set current speed.

Note: *The indicator changes color.*

You can adjust the set speed in small or large increments. Press the toggle button upward or downward once to adjust the set speed in small increments. Press and hold the toggle button upward or downward to adjust the set speed in large increments.

You can also adjust the set speed by braking.

Note: *Pressing the brake pedal does not switch off the system.*

CANCELING THE SET SPEED - RAPTOR



Press the button.

Trail Control

TRAIL CONTROL INDICATORS - RAPTOR



TRAIL ONE PEDAL DRIVE

WHAT IS TRAIL ONE PEDAL DRIVE

Trail one pedal drive allows you to accelerate and brake using only the accelerator pedal. The system assists when driving through difficult off-road terrain. Pressing the accelerator pedal down accelerates your vehicle and releasing pressure on the accelerator pedal, with your foot still on the pedal, slows your vehicle down. Releasing the accelerator pedal may allow your vehicle to come to a complete stop, some situations may require you to press the brake pedal to come to a complete stop.

TRAIL ONE PEDAL DRIVE PRECAUTIONS



WARNING: This system is an extra driving aid. It does not replace your attention and judgment, or the need to apply the brakes. This system does NOT automatically brake your vehicle. If you fail to press the brake pedal when necessary, you may collide with another vehicle.

Shifting into drive (D) or reverse (R) does not cause the vehicle to move.

You can press the brake pedal to increase braking. This does not turn the system off.

Trail one pedal drive could apply the parking brake when your vehicle is not moving and not in park (P).

Note: Always check the transmission selection before accelerating.

Note: Only use trail one pedal drive on slippery or loose surfaces. Using trail one pedal drive on dry, hard surfaces could produce some vibration, driveline bind up and potential excessive tire and vehicle wear.

TRAIL ONE PEDAL DRIVE LIMITATIONS

Trail one pedal drive is unavailable when any of the following occur:

- Your vehicle is not in four-wheel drive high (4H) or four-wheel drive low (4L) modes.
- Using cruise control.
- Using trail control.
- You exceed 30 mph (48 km/h).

Releasing the accelerator pedal may allow your vehicle to come to a complete stop, some situations may require you to press the brake pedal to come to a complete stop.

SWITCHING TRAIL ONE PEDAL DRIVE ON AND OFF

Switching Trail One Pedal Drive On



Press the trail features button when in four-wheel drive high or four-wheel drive low to activate trail one pedal drive.

Switching Trail One Pedal Drive Off

Press the trail features button again to switch trail one pedal drive off.

Selecting a driveline mode other than four-wheel drive high or four-wheel drive low switches trail one pedal drive off.

Trail Control

If you exceed 40 mph (65 km/h) trail one pedal drive switches off.

 Pressing either button when trail one pedal drive is active turns trail control on and places trail one pedal drive into standby mode.



Switching from Trail Control to Trail One Pedal Drive

 When using trail control in four-wheel drive high or four-wheel drive low modes, you can switch to trail one pedal drive by pressing the button on the steering wheel.

TRAIL ONE PEDAL DRIVE INDICATORS



When trail one pedal drive is active, the indicator displays green in the instrument cluster. When the system is switched on but is unavailable or in standby mode, it displays grey.

TRAIL ONE PEDAL DRIVE – TROUBLESHOOTING

TRAIL ONE PEDAL DRIVE – INFORMATION MESSAGES

| Message | Action |
|---|--|
| Trail 1-Pedal Drive Active Use SET Button for Trail Control | Displays when trail one pedal drive is active, use the SET+ or SET- to switch to trail control. |
| Trail Control with Trail 1- Pedal Drive Off | Displays when you switch trail one pedal drive off. |
| Trail Control Enabled Use SET button to Set Speed Trail 1-Pedal Drive Available in 4H or 4L | Trail control is in a driveline state not supported for trail one pedal drive. Set a speed to activate trail control or change the driveline state to four-wheel drive high (4H) or four-wheel drive low (4L) modes to active trail one pedal drive. |

Trail Control

TRAIL CONTROL – TROUBLESHOOTING - RAPTOR

TRAIL CONTROL – INFORMATION MESSAGES

| Message | Details |
|---|--|
| Reduce Speed To Enter Trail Control | Displays when you must reduce your vehicle speed to use trail control. |
| Trail Control Not Available with Park Brake Applied | Displays when you must release the park brake to use trail control. |
| Trail Control Not Available While Pro Trailer Backup Assist™ Active | Displays when you must switch off the trailer backup assist to use trail control. |
| Trail Control Enabled Use SET Button to Set Speed | Displays when you successfully enabled trail control and can set a speed with the Set+ or Set- control. |
| Trail Control Off Driver Resume Control | Displays when a system fault has occurred when trail control was active and the driver must resume control. |
| Trail Control Off | Displays when the system has turned off. |
| Trail Control Fault See Manual | Displays when a system fault is present. See the trail control section in your Owner's Manual. See your authorized dealer for diagnosis. |
| Trail Control To Activate Select Gear | Displays when you must be in drive (D), neutral (N) or reverse (R) to use trail control. |
| Trail Control Not Available with Cruise Control Active | Displays when you must switch the cruise control off to use trail control. |
| Trail Control Not Available with Driver Door Open | Displays when you must close the driver door to use trail control. |
| Set Trail Control to 1MPH to Aid in Getting Unstuck in Sand | Displays when the system detects you may be stuck in sand and recommends using trail control on to the lowest set speed. Doing this could slowly pull sand under the tires to free the vehicle. |
| Set Trail Control to 2 km/h to Aid in Getting Unstuck in Sand | |
| Descent Control Now Active Press Trail Control Switch To Exit | Due to some driver action, Trail Control propulsion was turned off but the vehicle will still brake if descending a hill. The driver must press the Trail Control switch to turn the feature OFF, they can then turn it back on. |
| Trail Control Not Available with Seatbelt Off | Displays when you must have the seatbelt on to use trail control. |

Trail Turn Assist (If Equipped)

WHAT IS TRAIL TURN ASSIST

Trail turn assist can reduce the turning radius of your vehicle by applying the brakes to the inside rear wheel in low-speed, high steering-angle maneuvers.

TRAIL TURN ASSIST PRECAUTIONS

Note: *Do not use trail turn assist on dry, hard surfaced roads. Doing so can produce excessive noise, increase tire wear and may damage drive line, or braking components. Trail turn assist is only intended for slippery, or loose surfaces.*

You may hear noise from the anti-lock brake system while trail turn assist is active. This is normal operation.

TRAIL TURN ASSIST LIMITATIONS

Trail turn assist can only be used when the vehicle's four-wheel drive system is in the four-wheel drive high (4H), or four-wheel drive low (4L) modes.

Trail Turn Assist cannot be used when the vehicle's rear differential is locked. If the rear differential has recently been locked prior to Trail Turn Assist being turned on, Trail Turn Assist may not activate until it can confirm that the rear differential is unlocked.

SWITCHING TRAIL TURN ASSIST ON AND OFF

You can switch the trail turn assist on or off from the features section of the vehicle on screen display.

1. Press **Features** on the touchscreen.
2. Press **Trail Turn Assist**.

3. Switch **Trail Turn Assist** on or off.

Switch trail turn assist on when your vehicle is in four-wheel drive high (4H) or four-wheel drive low (4L).

The system activates when the:

- Vehicle speed is less than 12 mph (19.3 km/h).
- Rear differential is fully unlocked.
- Steering wheel is almost fully turned to the left or right.

Switch trail turn assist off by performing any of the following:

- Switch trail turn assist off from the features section of the vehicle on screen display.
- Select two-wheel drive high, or four-wheel drive auto.
- Switch on the rear locking differential.

TRAIL TURN ASSIST INDICATORS



When trail turn assist is on, one of these two indicators will be displayed, depending on the direction of the vehicle's last turn. When the feature is on but not in use, the indicator light will be gray. When the feature is active the indicator light will be green.

Trail Turn Assist (If Equipped)

TRAIL TURN ASSIST – TROUBLESHOOTING

TRAIL TURN ASSIST – INFORMATION MESSAGES

| Message | Details |
|--|---|
| Trail Turn Assist Available in 4L or 4H | Switch to four-wheel drive low (4L) or four-wheel drive high (4H) to activate trail turn assist. See Selecting a Four-Wheel Drive Mode (page 272). |
| Trail Turn Assist Not Available See Manual | Trail turn assist system malfunction could be present. If this condition persists, have your vehicle serviced. |
| Trail Turn Assist ON | You have activated trail turn assist. |
| Trail Turn Assist OFF | You have switched trail turn assist off. |

TRAIL TURN ASSIST – FREQUENTLY ASKED QUESTIONS

Why does Trail Turn Assist not activate after unlocking the rear differential?

The rear differential may not be fully disengaged. When possible, turn off the rear axle locker while driving straight before using trail turn assist. If you are already in a tight turn when you encounter this situation, driving the vehicle for a short distance in reverse could allow the differential to fully disengage.

Hill Descent Control (If Equipped)

WHAT IS HILL DESCENT CONTROL

Hill descent control allows the driver to set and maintain vehicle speed while descending steep slopes in various surface conditions.

HOW DOES HILL DESCENT CONTROL WORK

Hill descent control can maintain vehicle speeds on downhill slopes between 2–20 mph (3–32 km/h). Above 20 mph (32 km/h), the system remains on but the descent speed cannot be set or maintained.

Note: *The system does not function below 2 mph (3 km/h).*

The system requires a cool down interval after a period of sustained use. Hill descent control provides a warning in the message center and a tone sounds when the system is about to disengage for cooling. At this time, manually apply the brakes as needed to maintain descent speed.

Note: *The amount of time that the system can remain active before cooling varies with conditions.*

HILL DESCENT CONTROL PRECAUTIONS



WARNING: The system does not control speed in low traction conditions or extremely steep slopes. The system is designed to be an aid and does not relieve you of your responsibility to drive with due care and attention. Failure to follow this instruction could result in personal injury.



WARNING: Hill descent control cannot control descent in all surface conditions and circumstances, such as ice or extremely steep grades. Hill descent control is a driver assist system and cannot substitute for good judgment by the driver. Failure to do so may result in loss of vehicle control, crash or serious injury.



WARNING: The system does not replace the parking brake. When you leave your vehicle, always apply the parking brake and shift the transmission into park (P) for automatic transmission or first gear for manual transmission.

SWITCHING HILL DESCENT CONTROL ON AND OFF



Press the button on the instrument panel. A light illuminates and a tone sounds when the system is active.

SETTING THE HILL DESCENT SPEED

To increase or decrease the descent speed, press the accelerator or brake pedal, or use the SET + and SET - buttons on the steering wheel. Once you reach the preferred speed remove your feet from the pedals.

HILL DESCENT CONTROL INDICATOR



Illuminates when you switch hill descent control on.

Hill Descent Control (If Equipped)

HILL DESCENT CONTROL – TROUBLESHOOTING

HILL DESCENT CONTROL – INFORMATION MESSAGES

| Message | Action |
|---|---|
| For Hill Descent Reduce Speed XX MPH/km/h or Less | Your vehicle speed requirement for off-road mode entry has not been met. |
| For Hill Descent Select Gear | You need to select a transmission gear for hill descent mode. |
| Hill Descent Driver Resume Control | Hill descent control mode is deactivated and you must resume control. |
| Hill Descent Control Fault | A hill descent system fault is present. |
| Hill Descent Control Off System Cooling | The hill descent system is cooling due to overuse. |
| Hill Descent Control not available with Cruise Control Active | The hill descent system cannot activate while Cruise Control is actively controlling speed. |

Steering

ELECTRIC POWER STEERING

ELECTRIC POWER STEERING PRECAUTIONS



WARNING: The electric power steering system has diagnostic checks that continuously monitor the system. If a fault is detected, a message displays in the information display. Stop your vehicle as soon as it is safe to do so. Switch the vehicle off. After at least 10 seconds, switch the vehicle on and watch the information display for a steering system warning message. If a steering system warning message returns, have the system checked as soon as possible.



WARNING: If the system detects an error, you may not feel a difference in the steering, however a serious condition may exist. Have your vehicle checked as soon as possible. Failure to do so may result in loss of steering control.

Adapt your speed and driving behavior according to reduced steering assist.

Extreme continuous steering may increase the effort to steer. This occurs to prevent internal overheating and damage to the steering system. If this occurs, you will not lose the ability to steer your vehicle manually nor will it cause damage to the system. Normal steering and driving allows the system to cool down and steering assist returns to normal.

Note: There is no fluid reservoir to check or fill.

ELECTRIC POWER STEERING ADAPTIVE STEERING - VEHICLES WITH: ACTIVE STEERING

The adaptive steering system changes the steering ratio with changes to vehicle speed, optimizing the steering response in all conditions. The system also changes when you switch on the transmission tow/haul feature. When you select the tow/haul button, the adaptive steering system reduces vehicle sensitivity to steering inputs at higher vehicle speeds, while maintaining the ease of parking and maneuverability at low speeds.

Note: *The adaptive steering system continuously monitors for faults. If the system detects a fault, a message appears in the information display. If a red warning message displays, stop your vehicle as soon as it is safe to do so. The message could clear if the fault is no longer present. If an adaptive steering system warning message appears each time you start your vehicle, have the system checked as soon as possible.*

Note: *The system has a locking device. It remains mechanically locked at a fixed steering ratio with the lock engaged. You may notice a click when you turn your vehicle on or off.*

Note: *If your vehicle loses electrical power or detects a fault when you are driving, the system shuts down and you retain a normal steering function with a fixed steering ratio. During this time, it is possible that the steering wheel could not be straight when the vehicle is driving straight ahead. In addition, you could notice that the steering wheel angle required to steer your vehicle could be different.*

Steering

Note: During parking maneuvers, the adaptive steering system balances the driver workload for various steering wheel inputs and vehicle loading conditions. Under extreme operating conditions the system locking device could engage. This strategy prevents overheating and permanent damage to the adaptive steering system. Typical steering and driving maneuvers allow the system to cool and return to normal operation.

Adaptive Learning

Adaptive learning helps correct road irregularities and improves overall handling and steering. It communicates with the brake system to help operate advanced stability control and crash avoidance systems. Additionally, whenever you disconnect the battery or install a new battery, you must drive your vehicle a short distance before the system relearns the strategy and reactivates all systems.

STEERING – INFORMATION MESSAGES

| Message | Action |
|--|---|
| Steering Fault Service Now | The power steering system has detected a condition that requires service. Have your vehicle checked as soon as possible. |
| Steering Loss Stop Safely | The power steering system is not working. Stop your vehicle in a safe place. Have your vehicle checked as soon as possible. |
| Steering Assist Fault Service Required | The power steering system has detected a condition that requires service. Have your vehicle checked as soon as possible. |
| Steering Lock Malfunction Service Now | The steering system has detected a condition that requires service. Have your vehicle checked as soon as possible. |

STEERING – TROUBLESHOOTING

STEERING – WARNING INDICATORS



The adaptive steering system indicator illuminates if the system detects a fault during the continuous diagnostic checks.

Note: If a red warning message displays, stop your vehicle as soon as it is safe to do so.

Parking Aids (If Equipped)

PARKING AID PRECAUTIONS



WARNING: To help avoid personal injury, always use caution when in reverse (R) and when using the sensing system.



WARNING: The system may not detect objects with surfaces that absorb reflection. Always drive with due care and attention. Failure to take care may result in a crash.



WARNING: Traffic control systems, fluorescent lamps, inclement weather, air brakes, external motors and fans may affect the correct operation of the sensing system. This may cause reduced performance or false alerts.



WARNING: The system may not detect small or moving objects, particularly those close to the ground.



WARNING: The parking aid system can only assist you to detect objects when your vehicle is moving at parking speeds. To help avoid personal injury you must take care when using the parking aid system.



WARNING: The system may not function if the sensor is blocked.



WARNING: In cold and severe weather conditions the system may not function. Rain, snow and spray can all limit sensor performance.



WARNING: If damage occurs in the immediate area surrounding the sensor, have your vehicle checked as soon as possible.

Note: If your vehicle sustains damage leaving the sensors misaligned, this will cause inaccurate measurements or false alerts.

When you connect a trailer to your vehicle, the rear parking aid detects the trailer and provides an alert. Disable the parking aid when you connect a trailer to prevent the alert.

Note: Certain add-on devices installed around the bumper or fascia may create false alerts, for example, large trailer hitches, bike or surfboard racks, license plate brackets, bumper covers or any other device that could block the normal detection zone of the parking aid system. Aftermarket spare tires or spare tire covers mounted to the rear tailgate could cause false alerts from the park aid system. Remove the add-on device to prevent false alerts.

Note: Keep the sensors free from snow, ice and large accumulations of dirt. If the sensors are covered, the system's accuracy can be affected.

Do not clean the sensors with sharp objects.

Note: When using a programmed MyKey, you cannot switch the parking aids off. See **MyKey™** (page 96).

SWITCHING PARKING AID ON AND OFF



Press the parking aid button and use the menu to turn the system on and off.

The system can also be turned off using the pop-up message that appears when you are in reverse (R).

Parking Aids (If Equipped)

REAR PARKING AID

WHAT IS THE REAR PARKING AID

Rear parking sensors detect objects behind your vehicle when in reverse (R).

REAR PARKING AID LIMITATIONS

There is a decreased coverage area at the outer corners.

When using a programmed MyKey, you cannot switch the rear parking aid off.

The rear parking aid sensors are active when your vehicle is in reverse (R) and the vehicle speed is less than 5 mph (8 km/h).

The sensor coverage area is up to 71 in (180 cm) from the rear bumper.

The rear parking aid detects large objects when you shift into reverse (R) and any of the following occur:

- Your vehicle is moving backward at a low speed.
- Your vehicle is stationary but an object is approaching the rear of your vehicle at a low speed.
- Your vehicle is moving backward at a low speed and an object is moving towards your vehicle, for example another vehicle at a low speed.

The system shall provide no audible warning for the object behind the vehicle when in neutral (N) gear.

LOCATING THE REAR PARKING AID SENSORS



The rear parking aid sensors are in the rear bumper.

REAR PARKING AID AUDIBLE WARNINGS

A warning tone sounds when your vehicle approaches an object. As your vehicle moves closer to an object, the rate of the tone increases. The warning tone continuously sounds when an object is 12 in (30 cm) or less from the rear bumper.

If your vehicle remains stationary for a few seconds, the audible warning turns off. If your vehicle moves backward the tone sounds again.

Note: When the parking aid system sounds a tone, the audio system could reduce the set volume.

FRONT PARKING AID

WHAT IS THE FRONT PARKING AID

Front parking sensors detect objects in front of your vehicle.

Parking Aids (If Equipped)

FRONT PARKING AID LIMITATIONS

The front parking aid sensors are active when your vehicle is in any position other than park (P) and the vehicle speed is less than 5 mph (8 km/h).

The sensor coverage area is up to 28 in (70 cm) from the bumper.

If your vehicle is in reverse (R), the front parking aid detects objects when your vehicle is moving at a low speed or an object is moving toward your vehicle and provides an audible warning, for example another vehicle at a low speed. If your vehicle remains stationary for a few seconds, the audible warning turns off. Visual indication is always active in reverse (R).

If your vehicle is in any forward gear, the front parking aid provides audible warnings and visual indication when your vehicle is moving at a speed of 5 mph (8 km/h) or below and the system detects an object within the detection zone. If your vehicle remains stationary for a few seconds, the visual indication and audible warning turns off.

If your vehicle is in neutral (N), the front and rear sensors provide visual indication only when your vehicle is moving below a speed of 5 mph (8 km/h) and obstacles are detected inside the detection areas. Once your vehicle stops, the visual indication and audible warning stops after a few seconds.

LOCATING THE FRONT PARKING AID SENSORS



The front parking aid sensors are in the front bumper.

FRONT PARKING AID AUDIBLE WARNINGS

A warning tone sounds when there is an object within 28 in (70 cm) from the front bumper. As your vehicle moves closer to an object, the rate of the tone increases.

The warning tone continuously sounds when an object is 12 in (30 cm) or less from the front bumper.

Note: *If the detected object is 12 in (30 cm) or less from your vehicle, visual indication remains on.*

SIDE PARKING AID

WHAT IS THE SIDE PARKING AID

The front and rear outermost parking aid sensors map objects that are near to the sides of your vehicle.

SIDE PARKING AID LIMITATIONS

The sensor coverage is up to 24 in (60 cm) from the sides of your vehicle.

Parking Aids (If Equipped)

The side parking aid may not function if:

- Your vehicle remains stationary for over two minutes.
- The anti-lock brake system activates.
- The traction control system activates.
- Your vehicle is in park (P).
- The steering wheel angle information is not available. You must drive at least 492 ft (150 m) above 19 mph (30 km/h) to reset the steering wheel angle information.

Note: If you switch traction control off, the side sensing system also turns off.

To reinitialize the system, drive the length of your vehicle.

The side parking aid does not detect an object that is moving toward the side of your vehicle, for example another vehicle moving at a low speed, if it does not pass a front or rear parking aid sensor.

If the transmission is in reverse (R), the side sensing system provides audible warnings. When your vehicle is moving slowly, obstacles are detected within 24 in (60 cm) and are inside the driving path of your vehicle. If your vehicle remains stationary for a few seconds, the audible warning turns off. Visual indication is always present in reverse (R).

If your vehicle is in neutral (N), the side sensing system provides visual indication only when your vehicle is moving slowly and there is a front or rear parking aid obstacle detected, and the side obstacle is within 24 in (60 cm) from the side of your vehicle. If your vehicle remains stationary for a few seconds, the visual indication turns off.

If the transmission is in drive (D) or any other forward gear, the side sensing system provides audible and visual warnings. When your vehicle is moving slowly, obstacles are detected within 24 in (60 cm) and are inside the driving path of your vehicle. If your vehicle remains stationary for a few seconds, the visual indication and audible warning turns off.

LOCATING THE SIDE PARKING AID SENSORS



The side parking sensors are in the front and rear bumpers.

SIDE PARKING AID AUDIBLE WARNINGS

When the side parking aid detects an object within the coverage area and the driving path of your vehicle, an audible warning sounds. As your vehicle moves closer to the object, the rate of the tone increases.

Parking Aids (If Equipped)

PARKING AID INDICATORS



The system provides object distance indication through the information display.

- As the distance to the object decreases, the indicator blocks illuminate and move toward the vehicle icon.
- If there is no object detected, the distance indicator blocks are grey.

Visual indication remains on when the transmission is in reverse (R). When you stop your vehicle, visual indication turns off after four seconds.

If the parking aids are not available, the side distance indicator blocks do not display.

PARKING AIDS – TROUBLESHOOTING

PARKING AIDS – INFORMATION MESSAGES

If a fault is present in the parking aids, a warning message appears in the instrument cluster or the information and entertainment display.

| Message | Action |
|-----------------------|--|
| Check Front Park Aid | The system detects a condition that requires service. Have your vehicle checked as soon as possible. |
| Check Rear Park Aid | The system detects a condition that requires service. Have your vehicle checked as soon as possible. |
| Front Park Aid On Off | Displays the park aid status. |
| Rear Park Aid On Off | Displays the park aid status. |

Rear View Camera

WHAT IS THE REAR VIEW CAMERA

The rear view camera provides a video image of the area behind your vehicle when the transmission is in reverse (R).



The rear view camera button is on the instrument panel.

REAR VIEW CAMERA PRECAUTIONS



WARNING: The rear view camera system is a reverse aid supplement device that still requires the driver to use it in conjunction with the interior and exterior mirrors for maximum coverage.



WARNING: Objects that are close to either corner of the bumper or under the bumper, might not be seen on the screen due to the limited coverage of the camera system.



WARNING: Reverse your vehicle slowly. Failure to follow this instruction could result in the loss of control of your vehicle, personal injury or death.



WARNING: Use caution when the rear cargo door is ajar. If the rear cargo door is ajar, the camera will be out of position and the video image could be incorrect. All guide lines disappear when the rear cargo door is ajar. Failure to follow this instruction could result in personal injury.



WARNING: Use caution when turning camera features on or off when the transmission is not in park (P). Make sure your vehicle is not moving.

Note: When towing, the camera only sees what you are towing. This might not provide adequate coverage and you might not see some objects. In some vehicles, the guide lines may disappear when you connect the trailer tow connector.

LOCATING THE REAR VIEW CAMERA

The rear view camera is on the tailgate. It provides a video image of the area behind your vehicle.

Rear View Camera

REAR VIEW CAMERA GUIDE LINES

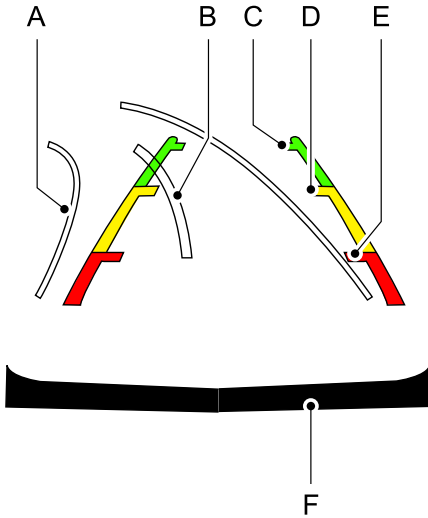

- A Active guide lines.
- B Centerline.
- C Fixed guide line: Green zone.
- D Fixed guide line: Yellow zone.
- E Fixed guide line: Red zone.
- F Rear bumper.

Active guide lines only show with fixed guide lines. To use active guide lines, turn the steering wheel to point the guide lines toward an intended path. If the steering wheel position changes while reversing, your vehicle might deviate from the intended path.

The fixed and active guide lines fade in and out depending on the steering wheel position. The active guide lines do not display when the steering wheel position is straight.

Use caution while reversing. Objects in the red zone are closest to your vehicle and objects in the green zone are farther away. Objects get closer to your vehicle as they move from the green zone to the yellow or red zones. Use the side view mirrors and rear view mirror to get better coverage on both sides and rear of your vehicle.

Note: Active guide lines and fixed guide lines are only available when the transmission is in reverse (R).

Note: The centerline is only available if the active or fixed guide lines are on.

Note: Not all camera modes work properly without an auxiliary camera.

REAR VIEW CAMERA SETTINGS

ZOOMING THE REAR VIEW CAMERA IN AND OUT

**WARNING:** When manual zoom is on, the full area behind your vehicle may not show. Be aware of your surroundings when using the manual zoom feature.

Selectable settings for this feature are zoom in (+) and zoom out (-). Press the symbol on the camera screen to change the view. The default setting is zoom off.

This allows you to get a closer view of an object behind your vehicle. The zoomed image keeps the bumper in the image to provide a reference. The zoom is only active while the transmission is in reverse (R).

Rear View Camera

Note: Zooming in also engages park hold which applies the electric park brake when you shift to park (P). When you press the zoom button, the electronic park hold button illuminates on the touchscreen. See **Connecting a Trailer** (page 399).

Note: Manual zoom is only available when the transmission is in reverse (R).

Note: Only the centerline shows when you enable manual zoom.

Note: The rear normal view and hitch view are also available when your vehicle is in drive (D).

SWITCHING REAR VIEW CAMERA DELAY ON AND OFF

1. Press **Features** on the touchscreen.
2. Press **Driver Assistance**.
3. Press **Rear View Camera**.
4. Switch **Rear View Camera Delay** on or off.

When shifting the transmission out of reverse (R) and into any gear other than park (P), the camera image remains in the display until:

- Your vehicle speed reaches approximately 5 mph (8 km/h).
- You shift your vehicle into park (P).

SWITCHING THE REAR VIEW CAMERA VIEW



Press to access the different camera views.



Rear normal view provides an image of what is directly behind your vehicle.



Rear split view provides an extended view of what is behind your vehicle.



The hitch view provides an image of the area around the tow hitch.

360 Degree Camera (If Equipped)

WHAT IS THE 360 DEGREE CAMERA

The 360 degree camera system consists of front, side and rear cameras which provide visibility around your vehicle.

HOW DOES THE 360 DEGREE CAMERA WORK

The 360 Degree Camera system:

- Allows you to see what is directly in front of or behind your vehicle.
- Provides a cross traffic view in front of and behind your vehicle.
- Allows you to see a top-down view of the area outside your vehicle, including the blind spots and obstacles near your vehicle.

360 DEGREE CAMERA PRECAUTIONS



WARNING: The 360 degree camera system still requires the driver to use it in conjunction with looking out of the windows, and checking the interior and exterior mirrors for maximum coverage.



WARNING: Objects that are close to either corner of the bumper or under the bumper, might not be seen on the screen due to the limited coverage of the camera system.



WARNING: Use caution when turning camera features on or off when the transmission is not in park (P). Make sure your vehicle is not moving.



WARNING: You are responsible for controlling your vehicle at all times. The system is designed to be an aid and does not relieve you of your responsibility to drive with due care and attention. Failure to follow this instruction could result in the loss of control of your vehicle, personal injury or death.



WARNING: Use caution when the rear cargo door is ajar. If the rear cargo door is ajar, the camera will be out of position and the video image could be incorrect. All guide lines disappear when the rear cargo door is ajar. Failure to follow this instruction could result in personal injury.



WARNING: When manual zoom is on, the full area behind your vehicle may not show. Be aware of your surroundings when using the manual zoom feature.

360 DEGREE CAMERA LIMITATIONS

Note: Use caution if a door is ajar. The 360 degree camera could be out of position and the image could be incorrect.

LOCATING THE 360 DEGREE CAMERAS

Rear View Camera

The rear view camera is on the tailgate. It provides a video image of the area behind your vehicle.

Front View Camera

The front view camera is in the grille. It provides a video image of the area in front of your vehicle.

360 Degree Camera (If Equipped)

Side View Camera

The side view camera is on the outside mirror. It provides a video image of the area on the sides of your vehicle to aid you when parking or when backing up a trailer.

Bed Camera

The bed camera is mounted within the high-mount stop lamp. It displays the contents of your truck bed. The camera contains a dynamic guideline to help locate the center of your vehicle. This view can be accessed while in drive (D) or reverse (R).

Auxiliary Camera

The auxiliary camera is a variant of the rear view camera and is accessed by pressing the AUX button on the display screen when moving in reverse (R) or in drive (D). It displays a rear view image from the back of a trailer while in reverse.

LOCATING THE 360 DEGREE CAMERAS-RAPTOR/TREMOR

Rear View Camera

The rear view camera is on the tailgate. It provides a video image of the area behind your vehicle.

Front View Camera

The front view camera is in the grille. It provides a video image of the area in front of your vehicle.

Note: *The front camera switches on when you are in mud/ruts, deep snow/sand, rock crawl, baja mode or in four-wheel drive low.*

Side View Camera

The side view camera is on the outside mirror. It provides a video image of the area on the sides of your vehicle to aid you when parking or when backing up a trailer.

Bed Camera

The bed camera is in the high-mount stop lamp. It displays the contents of your truck bed. The camera contains a dynamic guideline to help locate the center of your vehicle. You can access this view while in drive (D) or reverse (R).

Auxiliary Camera

The auxiliary camera is a variant of the rear view camera and you can access the auxiliary view by pressing the AUX button on the display screen when moving in reverse (R) or in drive (D). It displays a rear view image from the back of a trailer while in reverse.

360 DEGREE CAMERA GUIDE LINES

Note: *Active guide lines are only available when the transmission is in reverse (R).*

360 Degree Camera (If Equipped)

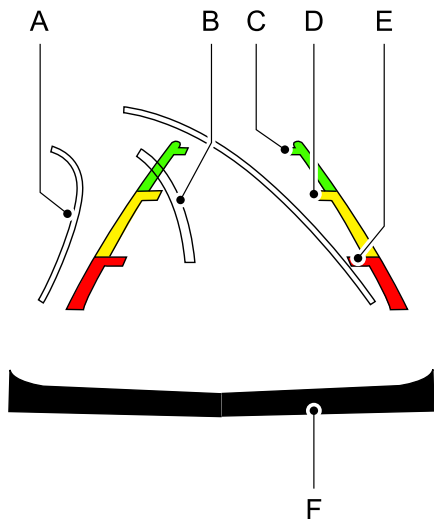

- A Active guide lines.
- B Centerline.
- C Fixed guide line: Green zone.
- D Fixed guide line: Yellow zone.
- E Fixed guide line: Red zone.
- F Rear bumper.

Active guide lines only show with fixed guide lines. Turn the steering wheel to point the guide lines toward an intended path. If the steering wheel position changes when reversing, your vehicle could deviate from the intended path.

The fixed and active guide lines fade in and out depending on the steering wheel position. The active guide lines do not display when the steering wheel position is straight.

Objects in the red zone are closest to your vehicle and objects in the green zone are farther away. Objects get closer to your vehicle as they move from the green zone to the yellow or red zones. Use the side view mirrors and rear view mirror to get better coverage on both sides and rear of your vehicle.

Keep Out Zone

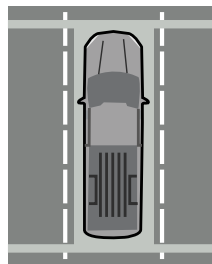

The keep out zone is represented by the yellow dotted lines running parallel to your vehicle.

360 DEGREE CAMERA SETTINGS

SWITCHING THE 360 DEGREE CAMERA ON AND OFF



The 360 degree camera system button is on the instrument panel. The front and rear cameras have multiple screens which consist of:

- Normal view.
- Normal view with 360.
- Split view.
- Bed camera.

360 Degree Camera (If Equipped)

- Auxiliary camera.
- Hitch view.

Note: *The rear view camera activates when you switch into reverse (R). Additional views are then accessible on the touchscreen.*

When in park (P), neutral (N) or drive (D), the front images display when the button is pressed. When in reverse (R), only the rear images display when the button is pressed.

Note: *Not all cameras are available.*

Note: *The 360 degree camera system turns off when your vehicle is in motion at low speed, except when in reverse (R).*

SWITCHING THE 360 DEGREE CAMERA VIEW



Press to access the different camera views.



Front normal view provides an image of what is directly in front of your vehicle.



Front split view provides an extended view of what is in front of your vehicle.



Normal + 360 degree view contains the normal camera view next to a 360 degree camera view.



Rear normal view provides an image of what is directly behind your vehicle.



Rear split view provides an extended view of what is behind your vehicle.



Bed camera shows the truck bed.



Trailer AUX camera shows a rear view camera image of what is behind your trailer. This camera needs to be purchased and installed separately.



The hitch view provides an image of the area around the tow hitch.



Trailer reverse guidance shows the sides of your truck and trailer. See **Trailer Reverse Guidance** (page 437).



Zooms in on the image and park hold is activated. See **Connecting a Trailer** (page 399).



Zooms in on the 360 degree image.

Note: *The rear normal view, bed camera view, hitch view and trailer auxiliary view are available when your vehicle speed is greater than 6 mph (10 km/h).*

Active Park Assist (If Equipped)

WHAT IS ACTIVE PARK ASSIST

Assists you with parking in and out of parking spaces.

HOW DOES ACTIVE PARK ASSIST WORK

Active park assist uses sensors to detect parking spaces. Active park assist controls steering, acceleration, braking and shifting as required to maneuver into or out of a parking space when activate.

ACTIVE PARK ASSIST PRECAUTIONS



WARNING: You must remain in your vehicle when the system turns on. At all times, you are responsible for controlling your vehicle, supervising the system and intervening, if required. Failure to take care may result in the loss of control of your vehicle, serious personal injury or death.



WARNING: The sensors may not detect objects in heavy rain or other conditions that cause interference.



WARNING: You are responsible for controlling your vehicle at all times. The system is designed to be an aid and does not relieve you of your responsibility to drive with due care and attention. Failure to follow this instruction could result in the loss of control of your vehicle, personal injury or death.



WARNING: Do not use the system with accessories that extend beyond the front or rear of your vehicle, for example a trailer hitch or bike rack. The system is not able to make corrections for the additional length of the accessories.

SWITCHING ACTIVE PARK ASSIST ON AND OFF



Press the parking aid button, then press the active park assist icon on the touchscreen to bring up full screen notifications.

Press the soft keys on the touchscreen to switch between the parallel park in, perpendicular park in, or parallel park out parking modes.

Cancelling Active Park Assist

To cancel parking assistance at any time, shift out of neutral (N).

Pausing Active Park Assist

To pause parking assistance at any time, release the parking aid button.

If you open the passenger or rear doors, active park assist pauses.

To resume parking, press and hold the parking aid button again.

ENTERING A PARALLEL PARKING SPACE

1. Press the parking aid button.

Note: *The system detects other vehicles and curbs to find a parking space.*

2. Press the active park assist icon on the touchscreen.

3. Select parallel parking.

Active Park Assist (If Equipped)

4. Use the turn signal lever to search for a parking space on the driver or passenger side of your vehicle.

Note: *If you do not use the turn signal lever, the system searches for a parking space on the passenger side of your vehicle.*

5. Drive your vehicle approximately 3 ft (1 m) away from and parallel to the other parked vehicles when searching for a parking space.

Note: *A tone sounds and a message appears in the information and entertainment display when active park assist finds a suitable parking space.*

6. Press and hold the brake pedal.
7. Release the steering wheel and shift into neutral (N).
8. Press and hold the active park assist button.
9. Release the brake pedal to allow your vehicle to park.

Note: *You can slow down your vehicle at any time by pressing the brake pedal.*

Note: *When parallel parking between objects, the system parks closer to the object in front of your vehicle to allow easier access to the luggage compartment.*

Note: *When parking is complete, your vehicle shifts into park (P).*

ENTERING A PERPENDICULAR PARKING SPACE

1. Press the parking aid button.

Note: *Active park assist does not recognize parking space lines and centers your vehicle between objects.*

2. Press the active park assist icon on the touchscreen.
3. Select perpendicular parking.

4. Use the turn signal lever to search for a parking space on the driver or passenger side of your vehicle.

Note: *If you do not use the turn signal lever, the system searches for a parking space on the passenger side of your vehicle.*

5. Drive your vehicle approximately 3 ft (1 m) away from and perpendicular to the other parked vehicles when searching for a parking space.

Note: *A tone sounds and a message appears in the information and entertainment display when active park assist finds a parking space.*

6. Press and hold the brake pedal.
7. Release the steering wheel and shift into neutral (N).
8. Press and hold the parking aid button.
9. Release the brake pedal to allow the vehicle to park.

Note: *Active park assist backs your vehicle into parking spaces.*

Note: *Active park assist aligns the front end of your vehicle with the lane side of the object next to it.*

Note: *When the system detects only one object, it allows enough distance to open the door on either side.*

Note: *You can slow down your vehicle at any time by pressing the brake pedal.*

Note: *When parking is complete, your vehicle shifts into park (P).*

EXITING A PARKING SPACE

Active park assist only assists leaving parallel parking spaces.

1. Press the parking aid button.
2. Press the active park assist icon on the touchscreen.
3. Select parallel park exit.

Active Park Assist (If Equipped)

4. Use the turn signal to choose the direction to exit the parking space.
5. Press and hold the brake pedal.
6. Release the steering wheel and shift into neutral (N).
7. Release the parking brake.
8. Press and hold the parking aid button.
9. Release the brake pedal to allow your vehicle to move.

Note: After active park assist drives your vehicle to a position where you can exit the parking space in a forward movement, a message appears instructing you to take full control of your vehicle.

10. Take control of your vehicle.

Note: You can slow down your vehicle at any time by pressing the brake pedal.

ACTIVE PARK ASSIST – TROUBLESHOOTING

ACTIVE PARK ASSIST – INFORMATION MESSAGES

| Message | Action |
|-------------------|---|
| Active Park Fault | The system requires service. Have your vehicle checked as soon as possible. |

ACTIVE PARK ASSIST – FREQUENTLY ASKED QUESTIONS

Why does active park assist not operate correctly?

The system is unable to detect a vehicle, curb or object to park next to or in between. The system needs boundary objects to operate correctly.

Why does active park assist not search for a parking space?

You have switched traction control off.

Why does active park assist not search for a parking space?

The transmission is in reverse (R). Your vehicle must be moving forward to be able to detect a parking space.

Why does active park assist not offer a parking space?

The sensors could be blocked. For example, snow, ice or large accumulations of dirt. Blocked sensors can affect how the system functions.

Why does active park assist not offer a parking space?

The sensors in the front or rear bumper could be damaged.

Why does active park assist not offer a parking space?

There is not enough room in the parking space for your vehicle to safely park.

Why does active park assist not offer a parking space?

There is not enough space for the parking maneuver on the opposite side of the parking space.

Why does active park assist not offer a parking space?

The parking space is more than 5 ft (1.5 m) or less than 2 ft (0.5 m) away from your vehicle.

Why does active park assist not offer a parking space?

Your vehicle's speed is greater than 22 mph (35 km/h) for parallel parking or greater than 19 mph (30 km/h) for perpendicular parking.

Active Park Assist (If Equipped)

Why does active park assist not offer a parking space?

You recently disconnected or replaced the battery. After you reconnect the battery you must drive your vehicle on a straight road for a short period of time.

Why does active park assist not correctly position the vehicle into a parking space?

An irregular curb along the parking space prevents the system from correctly aligning your vehicle.

Why does active park assist not correctly position the vehicle into a parking space?

Vehicles or objects bordering the space could not be correctly parked.

Why does active park assist not correctly position the vehicle into a parking space?

Your vehicle stopped too far past the parking space.

Why does active park assist not correctly position the vehicle into a parking space?

The tires are not correctly installed or maintained. For example, using a spare tire, not inflated correctly, improper size, or of different sizes.

Why does active park assist not correctly position the vehicle into a parking space?

A repair or alteration changed the detection capabilities.

Why does active park assist not correctly position the vehicle into a parking space?

A parked vehicle has a high attachment. For example, a salt sprayer, snowplow or moving truck bed.

Why does active park assist not correctly position the vehicle into a parking space?

The parking space length, or position of parked objects, changes after your vehicle passes the space.

Why does active park assist not correctly position the vehicle into a parking space?

The temperature around your vehicle quickly changes. For example, driving from a heated garage into a cold outside temperature, or after leaving a car wash.

Cruise Control (If Equipped)

WHAT IS CRUISE CONTROL

Cruise control lets you maintain a set speed without keeping your foot on the accelerator pedal.

Requirements

Use cruise control when the vehicle speed is greater than 15 mph in imperial units and 20 km/h in metric units.

SWITCHING CRUISE CONTROL ON AND OFF



WARNING: Do not use cruise control on winding roads, in heavy traffic or when the road surface is slippery. This could result in loss of vehicle control, serious injury or death.

The cruise controls are on the steering wheel.

Switching Cruise Control On



Press the button to activate the system. When the system activates, the set speed is equal to whichever is greater, the current vehicle speed, or 15 mph when in imperial units or 20 km/h when in metric units. If the speed is too low, or other conditions are not correct for cruise control activation, the system will instead enter standby mode.

Switching Cruise Control Off



Press the button when the system is active or switch the ignition off.

Note: When you switch cruise control off, the set speed clears.

SETTING THE CRUISE CONTROL SPEED



WARNING: When you are going downhill, your vehicle speed could increase above the set speed. The system does not apply the brakes.

Drive to the speed you prefer.

SET+

Press either the SET+ or SET- buttons to set the current speed.

SET-

Take your foot off the accelerator pedal.

Note: The indicator changes color in the information display.

Changing the Set Speed

SET+

Press the SET+ button to increase the set speed in small increments. Press and hold the SET+ button to accelerate. Release the button when you have reached your preferred speed.

SET-

Press the SET- button to decrease the set speed in small increments. Press and hold the SET- button to decelerate. Release the button when you have reached your preferred speed.

Note: If you accelerate by pressing the accelerator pedal, the set speed does not change. When you release the accelerator pedal, your vehicle returns to the speed that you previously set.

Cruise Control (If Equipped)

CANCELING THE SET SPEED



Press the button, or tap the brake pedal to cancel the set speed.

Note: *The system remembers the set speed.*

Note: *The system cancels if the vehicle speed drops below 10 mph (16 km/h) under the set speed when driving uphill.*

RESUMING THE SET SPEED



Press the button.

CRUISE CONTROL INDICATORS



Illuminates when you switch the system on.

Adaptive Cruise Control (If Equipped)

HOW DOES ADAPTIVE CRUISE CONTROL WITH STOP AND GO WORK

Adaptive cruise control with stop and go uses radar and camera sensors to maintain a set gap between your vehicle and the vehicle in front of you while following it to a complete stop. Stop and go can also be set to follow a vehicle directly in front of you and adjust the set speed, while you are at a complete stop.

ADAPTIVE CRUISE CONTROL PRECAUTIONS



WARNING: You are responsible for controlling your vehicle at all times. The system is designed to be an aid and does not relieve you of your responsibility to drive with due care and attention. Failure to follow this instruction could result in the loss of control of your vehicle, personal injury or death.



WARNING: Do not use adaptive cruise control on winding roads, in heavy traffic or when the road surface is slippery. This could result in loss of vehicle control, serious injury or death.



WARNING: Pay close attention to changing road conditions such as entering or leaving a highway, on roads with intersections or roundabouts, roads without visible lanes of travel, roads that are unpaved, or steep slopes. Failure to follow this instruction could result in the loss of control of your vehicle, personal injury or death.



WARNING: The system is not a crash warning or avoidance system.



WARNING: Do not use the system when towing a trailer that has aftermarket electronic trailer brake controls. Failure to follow this instruction could result in the loss of control of your vehicle, personal injury or death.



WARNING: Do not use tire sizes other than those recommended because this can affect the normal operation of the system. Failure to do so may result in a loss of vehicle control, which could result in serious injury.



WARNING: Do not use the system with a snow plow blade installed.



WARNING: Do not use the system in poor visibility, for example fog, heavy rain, spray or snow.

When Following a Vehicle



WARNING: When following a vehicle that is braking, your vehicle does not always decelerate quickly enough to avoid a crash without driver intervention. Apply the brakes when necessary. Failure to follow this instruction could result in personal injury or death.

Hilly Condition Usage

Select a lower gear when the system is active in situations such as prolonged downhill driving on steep slopes, for example in mountainous areas.

Adaptive Cruise Control (If Equipped)

ADAPTIVE CRUISE CONTROL LIMITATIONS

Sensor Limitations

WARNING: On rare occasions, detection issues can occur due to the road infrastructures, for example bridges, tunnels and safety barriers. In these cases, the system may brake late or unexpectedly. At all times, you are responsible for controlling your vehicle, supervising the system and intervening, if required.

WARNING: If the system malfunctions, have your vehicle checked as soon as possible.

WARNING: Large contrasts in outside lighting can limit sensor performance.

WARNING: The system only warns of vehicles detected by the radar sensor. In some cases there may be no warning or a delayed warning. Apply the brakes when necessary. Failure to follow this instruction could result in personal injury or death.

WARNING: The system may not detect stationary or slow moving vehicles below 6 mph (10 km/h).

WARNING: The system does not detect pedestrians or objects in the road.

WARNING: The system does not detect oncoming vehicles in the same lane.

WARNING: The system may not operate properly if the sensor is blocked. Keep the windshield free from obstruction.

WARNING: The sensor may incorrectly track lane markings as other structures or objects. This can result in a false or missed warning.

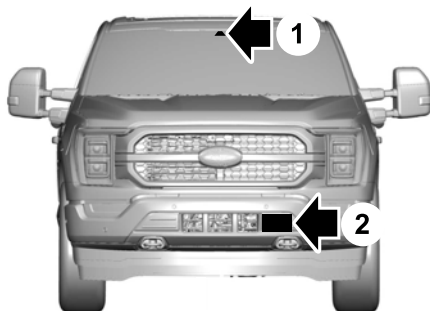

1. Camera.
2. Radar sensor.

The camera is on the windshield behind the interior mirror.

The radar sensor is in the lower grille.

Note: You cannot see the sensor. It is behind a fascia panel.

Note: Keep the front of your vehicle free of dirt, metal badges or objects. Vehicle front protectors, aftermarket lights, additional paint or plastic coatings could also degrade sensor performance.

A message displays if something obstructs the camera or the sensor. When something blocks the sensor, the system cannot detect a vehicle ahead and does not function. See **Adaptive Cruise Control – Information Messages** (page 341).

Adaptive Cruise Control (If Equipped)

The radar sensor has a limited field of view. It may not detect vehicles at all or detect a vehicle later than expected in some situations. The lead vehicle image does not illuminate if the system does not detect a vehicle in front of you.

Detection Issues Can Occur:

A

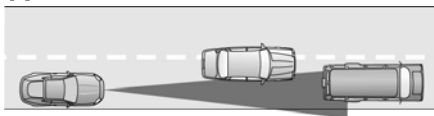

B

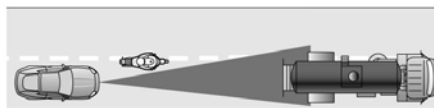

C

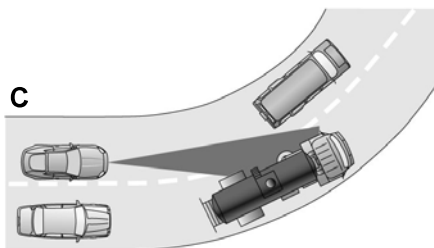

- A When driving on a different line than the vehicle in front.
- B With vehicles that edge into your lane. The system can only detect these vehicles once they move fully into your lane.
- C There may be issues with the detection of vehicles in front when driving into and coming out of a bend or curve in the road.

In these cases, the system may brake late or unexpectedly.

If something hits the front end of your vehicle or damage occurs, the radar-sensing zone may change. This could cause missed or false vehicle detection.

Optimal system performance requires a clear view of the road by the windshield camera.

Optimal performance may not occur if:

- The camera is blocked.
- There is poor visibility or lighting conditions.
- There are bad weather conditions.

SWITCHING ADAPTIVE CRUISE CONTROL ON AND OFF

The cruise controls are on the steering wheel. See **Visual Search** (page 32).

Switching Adaptive Cruise Control On



Press the button to activate the system. When the system activates, the set speed is equal to whichever is greater, the current vehicle speed, or 15 mph when in imperial units or 20 km/h when in metric units. If the speed is too low, or other conditions are not correct for adaptive cruise control activation, the system enters standby mode. When you are below 15 mph when in imperial units or 20 km/h when in metric units, adaptive cruise control does not activate unless you are following another vehicle.

The indicator, current gap setting and set speed appear in the instrument cluster display.

Adaptive Cruise Control (If Equipped)

Switching Adaptive Cruise Control Off



Press the button when the system is in standby mode or switch the ignition off.

Note: When you switch the system off, the set speed clears.

ADAPTIVE CRUISE CONTROL AUTOMATIC CANCELLATION

The system may cancel if:

- The tires lose traction.
- You apply the parking brake.

The system may cancel and set the parking brake if:

- You unbuckle the seatbelt and open the driver door after you stop your vehicle.
- Your vehicle is at a stop continuously for more than three minutes.

The system may deactivate or prevent activating when requested if:

- The vehicle has a blocked sensor.
- The brake temperature is too high.
- There is a failure in the system or a related system.

SETTING THE ADAPTIVE CRUISE CONTROL SPEED

Drive to the speed you prefer.



Press the SET+ or SET- buttons to set the current speed.



Take your foot off the accelerator pedal.

The indicator, current gap setting and set speed appear in the instrument cluster display.

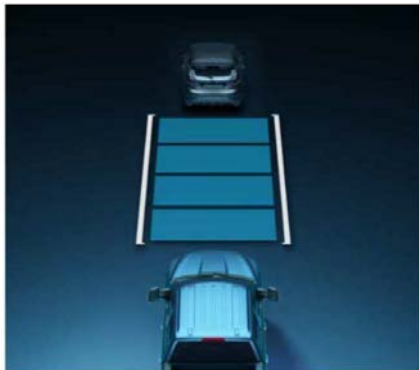

A vehicle image illuminates if there is a vehicle detected in front of you.

Note: When adaptive cruise control is active, the speedometer may vary slightly from the set speed displayed in the instrument cluster display.

Setting the Adaptive Cruise Speed from a Complete Stop



Press the SET+ or SET- buttons while keeping the brake pedal fully depressed.



The set speed adjusts to 20 km/h when in metric units or 15 mph when in imperial units.

The indicator, current gap setting and set speed appear in the instrument cluster display.

Note: The system activates from a complete stop only when it detects a lead vehicle in close proximity.

Adaptive Cruise Control (If Equipped)

Manually Changing the Set Speed

SET+ Press the SET+ button to increase the set speed in small increments. Press and hold the SET+ button to increase set speed in large increments. Release the button when the indicated set speed reaches the preferred speed.

SET- Press the SET- button to decrease the set speed in small increments. Press and hold the SET- button to decrease the set speed in large increments. Release the button when the indicated set speed reaches the preferred speed.

You can also press the accelerator or brake pedal until you reach the speed you prefer. Press the SET+ or SET- button to select the current speed as the set speed.

The system may apply the brakes to slow the vehicle to the new set speed. The set speed continuously displays in the instrument cluster display when the system is active.

SETTING THE ADAPTIVE CRUISE CONTROL GAP

 Press the button to cycle through the four gap settings.

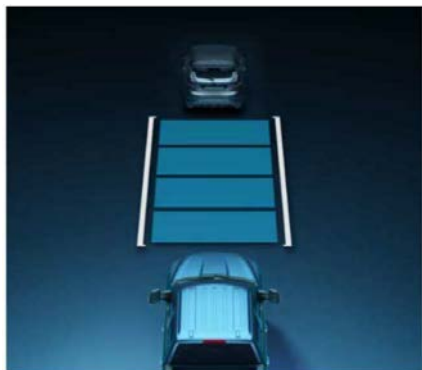

The selected gap appears in the information display as shown by the bars in the image.

Note: *The gap setting is time dependent and therefore, the distance adjusts with your vehicle speed.*

Note: *It is your responsibility to select a gap appropriate to the driving conditions.*

Adaptive Cruise Control Gap Settings

| Graphic Display, Bars Indicated Between Vehicles | Gap Distance | Dynamic Behavior |
|--|--------------|------------------|
| 1 | Closest. | Sport. |
| 2 | Close. | Normal. |
| 3 | Medium. | Normal. |
| 4 | Far. | Comfort. |

Each time you switch the system on, it selects the last chosen gap setting.

Adaptive Cruise Control (If Equipped)

Following a Vehicle

When a vehicle ahead of you enters the same lane or a slower vehicle is ahead in the same lane, the vehicle speed adjusts to maintain the gap setting.

Note: *When you are following a vehicle and you switch on a turn signal lamp, adaptive cruise control may provide a small, temporary acceleration to help you pass.*

Your vehicle maintains a consistent gap from the vehicle ahead until:

- The vehicle in front of you accelerates to a speed above the set speed.
- The vehicle in front of you moves out of the lane you are in.
- You set a new gap distance.

The system applies the brakes to slow down your vehicle to maintain a safe gap distance from the vehicle in front of you. The system only applies limited braking. You can override the system by applying the brakes.

Note: *The brakes may emit noise when applied by the system.*

If the system determines that its maximum braking level is not sufficient, an audible warning sounds, a message appears in the information display and an indicator flashes when the system continues to brake. Take immediate action.

CANCELING THE SET SPEED



Press the button or tap the brake pedal.

The set speed does not erase.

RESUMING THE SET SPEED



Press the button.

Your vehicle speed returns to the previously set speed and gap setting. The set speed displays continuously in the information display when the system is active.

Note: *Only use resume if you are aware of the set speed and intend to return to it.*

Resuming the Set Speed from a Complete Stop (If Equipped)

If your vehicle follows a vehicle to a complete stop and remains stationary for less than a few seconds, your vehicle accelerates from a stationary position to follow the vehicle ahead.

If your vehicle follows a vehicle to a complete stop and remains stationary for more than a few seconds, an indicator and message displays.



Adaptive Cruise Control (If Equipped)

| Message | Action |
|------------------------|--|
| Stopped | Cruise control does not resume automatically when this display is active. |
| Press button to resume | If the lead vehicle begins to move, you are prompted to press the resume button. Press and release the button or use the accelerator pedal to resume following the lead vehicle. |
| Auto-Resume | Displays when on a limited access highway after following a vehicle to a complete stop. In this situation, the vehicle resumes following the lead vehicle without a button press or pressing the accelerator pedal. The system can remain in auto-resume state for approximately 30 seconds, after which it no longer automatically resumes. |

OVERRIDING THE SET SPEED



WARNING: If you override the system by pressing the accelerator pedal, it does not automatically apply the brakes to maintain a gap from any vehicle ahead.

When you press the accelerator pedal, you override the set speed and gap distance.

Use the accelerator pedal to intentionally exceed the set speed limit.

When you override the system, the green indicator illuminates and the vehicle icon does not appear in the instrument cluster display.

The system resumes operation when you release the accelerator pedal. The vehicle speed decreases to the set speed, or a lower speed if following a slower vehicle.

ADAPTIVE CRUISE CONTROL INDICATORS



Illuminates when you switch adaptive cruise control on. The color of the indicator changes to indicate the system status.

White indicates the system is on but inactive.

Green indicates that you set the speed and the system is active.

SWITCHING FROM ADAPTIVE CRUISE CONTROL TO CRUISE CONTROL



WARNING: Normal cruise control will not brake when your vehicle is approaching slower vehicles. Always be aware of which mode you have selected and apply the brakes when necessary.

Adaptive Cruise Control (If Equipped)

1. Press **Features** on the touchscreen.
2. Press **Driver Assistance**.
3. Press **Cruise Control**.
4. Press **Normal Cruise Control**.



The cruise control indicator replaces the adaptive cruise control indicator if you select normal cruise control. The gap setting does not display, and the system does not respond to lead vehicles. Automatic braking remains active to maintain set speed. The system remembers the last setting when you start your vehicle.

LANE CENTERING

HOW DOES LANE CENTERING WORK

Adaptive cruise control with lane centering uses radar and camera sensors to help keep your vehicle in the middle of the lane by applying continuous assistance steering torque input toward the lane center on highways.

Note: *The adaptive cruise control gap setting operates normally.*

If you drive off-center within the lane, the system sets and maintains that preferred lane position. The system provides continuous assistance steering torque input toward the preferred position.

Note: *The system can only set preferred lane positions within the lane.*

Note: *If the system cancels, the preferred position erases. On the next activation, the system provides continuous assistance steering torque input toward the lane center.*

LANE CENTERING PRECAUTIONS



WARNING: Do not use the system when towing a trailer. Failure to follow this instruction could result in the loss of control of your vehicle, personal injury or death.



WARNING: Do not use the system if any changes or modifications to the steering wheel have been made. Any changes or modifications to the steering wheel could affect the functionality or performance of the system. Failure to follow this instruction could result in the loss of control of your vehicle, personal injury or death.

Adaptive cruise control precautions apply to lane centering unless stated otherwise or contradicted by a lane centering precaution. See **Adaptive Cruise Control Precautions** (page 331).

LANE CENTERING REQUIREMENTS

You must keep your hands on the steering wheel at all times.

The system only activates when all of the following occur:

- You have adaptive cruise control with stop and go on.
- Lane centering assist is enabled in your information and entertainment screen. See **Switching Lane Centering On and Off** (page 339).
- You have your hands on the steering wheel.
- The system detects both lane markings.

Note: *If it does not detect valid lane markings, the system stays inactive until valid markings are available.*

Adaptive Cruise Control (If Equipped)

LANE CENTERING LIMITATIONS

Adaptive cruise control limitations apply to lane centering unless stated otherwise or contradicted by a lane centering limitation. See **Adaptive Cruise Control Limitations** (page 332).

Lane Centering may not correctly operate in any of the following conditions:

- The lane is too narrow or wide.
- The system does not detect at least one lane marking or when lanes merge or split.
- Limited steering torque input is applied.
- Areas under construction or new infrastructure.
- When modifications to the steering system have been made.
- When using a spare tire.
- In high wind conditions.

Note: *The driving assistance torque is limited and may not be sufficient for all driving situations such as driving through tight curves or driving through curves at high speeds.*

Note: *In exceptional conditions, such as inclement weather or direct sunlight, the system could deviate from the center line or could cancel.*

SWITCHING LANE CENTERING ON AND OFF

You must keep your hands on the steering wheel at all times.

The controls are on the steering wheel.



Press the button.

The indicator appears in the information display. When the system is on, the color of the indicator changes to indicate the system status.

You can override the system at any time by steering your vehicle.

Note: *The correct requirements must be met before you can switch the system on. See **Lane Centering Requirements** (page 338).*

Enabling and Disabling Lane Centering

1. Press **Features** on the touchscreen.
2. Press **Driver Assistance**.
3. Press **Cruise Control**.
4. Press **Lane Centering Assist**.

LANE CENTERING ALERTS

You must keep your hands on the steering wheel at all times.

When the system is active and detects no steering activity for a period of time, the system alerts you to put your hands on the steering wheel. If you do not react to the warnings the system cancels and slows your vehicle down to idle speeds while maintaining steering control. See **Lane Centering Automatic Cancellation** (page 339).

The system also alerts you if your vehicle crosses lane markings without detected steering activity.

Note: *The system could detect a light grip or touch on the steering wheel as hands-off driving.*

LANE CENTERING AUTOMATIC CANCELLATION

When an external condition cancels the system, for example, no lane markings available, a tone sounds and a message appears in the instrument cluster display.

Adaptive Cruise Control (If Equipped)



If your vehicle starts to slow down, you must provide steering input to the wheel and press and release the button to regain full system performance.

Automatic cancellation can also occur if:

- The lane becomes too wide or too narrow.
- The system cannot detect valid lane markings.
- Lane markings cross over one another.

Note: *The system disables until the next key cycle if your vehicle slows down due to driver inactivity twice within a key cycle.*

LANE CENTERING INDICATORS



Illuminates when you switch lane centering on. The color of the indicator changes to indicate the system status.

Gray indicates the system is on but inactive.

Green indicates the system is active and applying steering torque assistance input to keep your vehicle in the center of the lane.

Amber with an audible tone and then gray indicates a system automatic cancellation.

INTELLIGENT ADAPTIVE CRUISE CONTROL

HOW DOES INTELLIGENT ADAPTIVE CRUISE CONTROL WORK

Intelligent adaptive cruise control combines speed sign recognition and navigation map data with adaptive cruise control to adjust the cruise set speed to the speed limit detected by the speed sign recognition system. As the system detects new speed signs, the set speed updates.

There are limitations that affect the accuracy of the speed sign recognition system and its ability to determine the current speed limit. The intelligent adaptive cruise control system and its ability to determine the current speed limit shares these limitations.

Note: *The adaptive cruise control gap setting operates normally when the feature is enabled.*

INTELLIGENT ADAPTIVE CRUISE CONTROL PRECAUTIONS



WARNING: You are responsible for controlling your vehicle at all times. The system is designed to be an aid and does not relieve you of your responsibility to drive with due care and attention. Failure to follow this instruction could result in the loss of control of your vehicle, personal injury or death.

INTELLIGENT ADAPTIVE CRUISE CONTROL REQUIREMENTS

Traffic sign recognition must be enabled for intelligent adaptive cruise control to be active.

Adaptive Cruise Control (If Equipped)

INTELLIGENT ADAPTIVE CRUISE CONTROL LIMITATIONS

The speed limit information provided by the navigation map data could be inaccurate or out of date.

The system may not detect and read speed limit signs with conditional information, for example, when a sign is flashing, during specific time ranges, or when children are present.

Note: *The system does not set the vehicle speed to speed limits shown with a supplementary traffic sign.*

Under certain conditions, the system may not adjust the vehicle speed until after your vehicle passes the speed limit.

SWITCHING INTELLIGENT MODE ON AND OFF

1. Press **Features** on the touchscreen.
2. Press **Driver Assistance**.
3. Press **Cruise Control**.
4. Press **Adaptive Cruise Control**.
5. Press **Speed Sign Recognition**.

ADJUSTING THE SET SPEED TOLERANCE

1. Press **Features** on the touchscreen.
2. Press **Driver Assistance**.
3. Press **Cruise Control**.
4. Press **Adaptive Cruise Control**.
5. Press **Speed Sign Recognition**.
6. Press **Tolerance**.
7. Use **+** and **-** to set the tolerance.

Note: *You cannot set the tolerance more than 20 mph (30 km/h) above or below the recognized speed.*

INTELLIGENT ADAPTIVE CRUISE CONTROL ALERTS

If you increase the set speed beyond the speed limit or speed limit plus a positive tolerance value, the set speed indicator flashes.

The warning does not occur if:

- You override the set speed using the accelerator pedal.
- The vehicle speed exceeds the set speed due to being on a downhill slope.

INTELLIGENT ADAPTIVE CRUISE CONTROL INDICATORS



The set speed limit displays next to the detected speed limit in the instrument cluster.

ADAPTIVE CRUISE CONTROL – TROUBLESHOOTING

ADAPTIVE CRUISE CONTROL – INFORMATION MESSAGES - VEHICLES WITH: LANE CENTERING

Note: *Depending on your vehicle options and instrument cluster type, not all messages display or are available.*

Adaptive Cruise Control (If Equipped)

Note: *The system could abbreviate or shorten certain messages depending upon which cluster type you have.*

| Message | Action |
|-------------------------------------|---|
| Keep Hands on Steering Wheel | Return your hands to the steering wheel and provide steering input to cancel the message. |
| Lane Centering Assist Not Available | To reset the feature when the vehicle is stationary, return the gear selector to park and turn the engine off. Restart the engine with your foot on the brake pedal. |
| Resume Control | You must immediately take full control of the vehicle. |
| Press Accelerator Pedal to Resume | Resume adaptive cruise control with lane centering by applying foot pressure on the accelerator pedal. You can also resume the feature by pressing the resume button on the steering wheel. |

Adaptive Cruise Control (If Equipped)

ADAPTIVE CRUISE CONTROL – INFORMATION MESSAGES - VEHICLES WITH: STOP AND GO

Note: Depending on your vehicle options and instrument cluster type, not all messages display or are available.

Note: The system could abbreviate or shorten certain messages depending upon which cluster type you have.

| Message | Action |
|---|---|
| Adaptive Cruise Malfunction | A malfunction is preventing the adaptive cruise from engaging. |
| Front Sensor Not Aligned | Contact an authorized dealer to have the radar checked for proper coverage and operation. |
| Adaptive Cruise Not Available | Conditions exist preventing the system from being available. |
| Adaptive Cruise Not Available Sensor Blocked See Manual | You have a blocked radar because of poor radar visibility due to inclement weather or ice, mud, or water in front of the radar. You can typically clean the sensor to resolve this. Due to the nature of radar technology, it is possible to get a blockage warning with no actual block. This happens, for example, when driving in sparse rural or desert environments. A false blocked condition either self clears, or clears after you restart your vehicle. |
| Normal Cruise Active Adaptive Braking Off | You have selected normal cruise control. The system does not brake or react to traffic. |
| Adaptive Cruise - Driver Resume Control | Displays when the adaptive cruise control is going to cancel and you must take control. |
| Adaptive Cruise Speed Too Low to Activate | Displays when the vehicle speed is too slow to activate the adaptive cruise control and there is no lead vehicle in range. |

BlueCruise (If Equipped)

WHAT IS BLUECRUISE

BlueCruise keeps your vehicle centered in the lane and offers a hands-free driving mode in certain situations when using adaptive cruise control.

HOW DOES BLUECRUISE WORK

BlueCruise uses cameras to monitor your vehicle position within a lane and applies steering support to keep your vehicle centered in the lane.

Using the cameras and location information, BlueCruise allows you to remove your hands from the steering wheel and offers a hands-free driving mode in certain areas.

When active, BlueCruise uses a driver facing camera and infrared lighting to monitor your eyes and head position to detect if you are distracted. If the system determines you are distracted, it alerts you to return your eyes to the road.

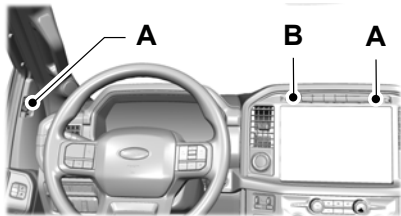

- A Lighting area.
- B Camera.

Note: When BlueCruise is active, in certain crash or near crash-like situations, such as an air bag deployment or hitting a road obstacle, camera data may record through the vehicle event data recorder. See **Event Data** (page 28).

Note: No data records under normal driving conditions.

BLUECRUISE PRECAUTIONS

WARNING: You are responsible for keeping your eyes on the road at all times. The system is designed to be an aid and does not relieve you of your responsibility to drive with due care and attention. Failure to follow this instruction could result in the loss of control of your vehicle, personal injury or death.

WARNING: You are responsible for controlling your vehicle at all times. The system is designed to be an aid and does not relieve you of your responsibility to drive with due care and attention. Failure to follow this instruction could result in the loss of control of your vehicle, personal injury or death.

WARNING: Do not use the system when towing a trailer. Failure to follow this instruction could result in the loss of control of your vehicle, personal injury or death.

WARNING: Obstructions to the driver facing camera or infrared lighting could prevent the system from properly operating. Keep the camera and lighting areas free from obstruction. Failure to follow this instruction could result in the loss of control of your vehicle, personal injury or death.

BlueCruise (If Equipped)

 **WARNING:** Do not use the system if any changes or modifications to the steering wheel have been made. Any changes or modifications to the steering wheel could affect the functionality or performance of the system. Failure to follow this instruction could result in the loss of control of your vehicle, personal injury or death.

 **WARNING:** The system may not function if the sensor is blocked.

 **WARNING:** Pay close attention to changing road conditions such as entering or leaving a highway, on roads with intersections or roundabouts, roads without visible lanes of travel, roads that are winding, slippery, unpaved, or steep slopes.

 **WARNING:** The system is not a crash warning or avoidance system.

 **WARNING:** Large contrasts in outside lighting can limit sensor performance.

 **WARNING:** The system attempts to keep your vehicle in the center of the lane as well as maintain speed and gap control. The system may not be able to perform these tasks in all situations. Do not use the system in complex or uncertain driving conditions. Failure to follow this instruction could result in the loss of control of your vehicle, personal injury or death.

 **WARNING:** Your vehicle could drift out of the lane of travel. Always be prepared to manually steer your vehicle. Failure to follow this instruction could result in the loss of control of your vehicle, personal injury or death.

 **WARNING:** The system will not operate if the sensor cannot track the road lane markings.

BLUECRUISE REQUIREMENTS

BlueCruise only activates when all of the following occur:

- BlueCruise is enabled in your information and entertainment screen. See **BlueCruise Settings** (page 346).
- Adaptive cruise control is on.
- The system detects both lane markings.
- Your hands are on the steering wheel.
- Your eyes are on the road.

Note: *For hands-free mode to work, your vehicle must be on certain limited access divided freeways.*

Note: *The system may require updated software for hands-free mode. See **Vehicle System Updates** (page 633).*

BLUECRUISE LIMITATIONS

Any of the following conditions could result in BlueCruise not correctly operating:

- You do not have your vehicle centered in the lane.
- The lane is too narrow or too wide.
- The system does not detect at least one lane marking or when lanes merge or split.
- You are applying a low amount of steering input.
- You are using the system in areas under construction.
- If you make any aftermarket modifications to the steering system.
- You are using a spare tire.

BlueCruise (If Equipped)

The driver-facing camera may not operate correctly due to any of the following:

- You have a pre-existing eye condition, such as an eye misalignment, or have had eye surgery.
- You cover your facial features by a mask, hat or other items.
- The lighting conditions change significantly.
- You are not in the field of view of the camera.
- You position or tilt yourself to one side.
- You are moving around extensively.
- You are wearing glasses or sunglasses that are too dark or reflective.

Note: *The system has limited steering assistance and may not be sufficient for all driving situations.*

Note: *In exceptional conditions, such as inclement weather or direct sunlight, the system could deviate from the center line.*

Note: *The information provided by the navigation map data could be inaccurate or out of date.*

BLUECRUISE SETTINGS

Enabling BlueCruise

1. Press **Features** on the touchscreen.
2. Press **Driver Assistance**.
3. Press **Cruise Control**.
4. Press **Lane Centering with Hands-Free**.

Enabling Activation Prompts

1. Press **Features** on the touchscreen.
2. Press **Driver Assistance**.
3. Press **Cruise Control**.
4. Press **Activation Prompts**.

SWITCHING BLUECRUISE ON AND OFF

Switching BlueCruise On

The controls are on the steering wheel.

Using Activation Prompts



When the prompt appears, press the button to switch BlueCruise on.

The indicator appears in the instrument cluster. When the system is on, the color of the indicator changes to indicate the system status.

Note: *You must enable activation prompts in the touchscreen.*

Using Steering Wheel Controls



Using the adaptive cruise control and lateral support buttons, ensure both systems are active. BlueCruise activates.



Switching BlueCruise Off



Press either the lateral support or adaptive cruise control button when system is active or in standby mode.



BlueCruise turns off through each ignition cycle.

BlueCruise (If Equipped)

BLUECRUISE ALERTS

When BlueCruise is providing hands-on driving or transitioning to hands-on driving from hands-free driving and detects no steering activity for a certain period of time, the system alerts you with a message in the instrument cluster to put your hands on the steering wheel. After the first alert, the system alerts you with a message in the instrument cluster and an audible warning.

When BlueCruise is providing hands-on or hands-free driving and detects you are not looking at the road for a certain period of time, the system alerts you to return your eyes to the road. Depending on where you are looking, the alert can be a message in the instrument cluster and an audible warning.

If you do not react to the warnings, BlueCruise cancels, quickly activates and releases the brakes, and slows your vehicle down to low speeds while maintaining steering control.

If your vehicle slows down and you resume control, a message appears to prompt you to press the accelerator pedal to allow the system to resume.

Note: *If the system detects repeated inactivity, it disables until the next key cycle.*

BLUECRUISE AUTOMATIC CANCELLATION

When an external condition cancels BlueCruise, for example, no lane markings available, a tone sounds and a message appears in the instrument cluster.



If your vehicle starts to slow down, you must take control of steering and press and release the button to reactivate BlueCruise.

System cancellation can also occur if:

- The lane becomes too narrow.
- The system cannot detect valid lane markings.
- Lane markings cross.
- Your eyes are not on the road or your hands are not the steering wheel.

If you have your hands on the steering wheel and your eyes are on the road when the feature is active and a cancellation occurs, the system sounds a tone and displays a cancelled graphic in the instrument cluster.

If you are not paying attention to the road or your hands are not on the steering wheel and a cancellation occurs, the system displays a message and a tone sounds until you resume control. If you do not resume control in time, BlueCruise quickly activates and releases the brakes, and slows your vehicle down to low speeds while maintaining steering control. If your vehicle slows down and you resume control, a message appears to prompt you to press the accelerator pedal to allow the system to resume.

Note: *The system disables until the next key cycle if it detects repeated inactivity.*

BLUECRUISE INDICATORS



When on, the color of the indicator changes to indicate the status.

Gray indicates BlueCruise is on but inactive.

Green indicates BlueCruise is active and applying continuous steering support.

Blue indicates BlueCruise is active and hands-free driving mode is available.

BlueCruise (If Equipped)

Hands-On Driving Support Available



The graphic in the cluster changes to a wheel with hands on it indicating hands-on driving mode is active.

When this indicator is present, you must keep your hands on the steering wheel.

Hands-Free Driving Support Available



The graphic in the cluster changes to a wheel without hands on it indicating hands-free driving mode is available.

When this indicator is present, you can remove your hands from the steering wheel.

BLUECRUISE – TROUBLESHOOTING

BLUECRUISE – INFORMATION MESSAGES

Depending on your vehicle options and instrument cluster type, not all messages display or are available.

| Message | Details |
|------------------------------|---|
| Keep Hands on Steering Wheel | Make sure you return your hands to the steering wheel and provide steering input. |
| Resume Control | The system is going to cancel and you must take control. |
| Watch the Road | Return your attention to the road. |

BlueCruise (If Equipped)

| Message | Details |
|--|--|
| BlueCruise not available | Conditions exist preventing the system from being available. If the message continues to display, have the system checked as soon as possible. |
| Press Accelerator Pedal to Resume | Press the accelerator pedal and follow the prompts. |
| Driver monitor camera cannot detect face See manual | Make sure your facial features are visible and in the field of view of the driver facing camera. |
| Driver monitor camera is blocked See manual | Make sure your hands, arms or other objects are not obscuring the camera. |
| Driver monitor camera fault See manual | Conditions exist preventing the system from being available. If the message continues to display, have the system checked as soon as possible. |
| BlueCruise On Watch the road Be prepared to resume control | BlueCruise is active, keep your attention on the road. |
| BlueCruise available Press {ICON} to activate | The system is in standby mode, press the button on the steering wheel to activate. |

Note: *The instrument cluster display may abbreviate or shorten certain messages.*

Drive Mode Control

WHAT IS DRIVE MODE CONTROL

Your vehicle has various drive modes that you can select for different driving conditions. Depending on the drive mode that you select, the system adjusts various vehicle settings.

HOW DOES DRIVE MODE CONTROL WORK

Selectable drive modes change various electronic and mechanical settings within your vehicle to tailor its performance and driving characteristics to on-road or off-road driving conditions. Steering feel and effort, traction control, stability control, chassis controls, powertrain response, transmissions shift points, four-wheel driveline setting, exhaust noise level and suspension dampening are automatically altered to a pre-determined setting depending upon the drive mode that is selected.

Note: Your vehicle has diagnostic checks that continuously monitor all systems for proper operation. If a drive mode is unavailable due to a system fault, your vehicle defaults to normal mode and the driveline remains in the four-wheel drive setting that was last selected prior to the system fault.

Note: Your vehicle reverts to normal mode each time it is started. If you shut your vehicle off in a drive mode other than normal mode, at startup the instrument cluster screen displays a pop-up asking if you would like to return to your last used drive mode. If you select yes to the pop-up, your vehicle returns to the last selected drive mode and the default four-wheel driveline setting associated with that drive mode. If you select no, your vehicle remains in normal mode and the default four-wheel driveline setting associated with that drive mode. If you do not select yes or no the pop up message times out, your vehicle remains in normal mode, and the four-wheel driveline setting remains in its last used setting.

SELECTING A DRIVE MODE



Rotate the drive mode control on the center console to select or change a drive mode.

Note: Button icons vary depending on the vehicle.

Drive Mode Control

SELECTING A DRIVE MODE - RAPTOR



Rotate the drive mode control on the center console to select or change a drive mode.

Note: Button icons vary depending on the vehicle.

Selecting a Steering Mode



To change the steering feel, press the button on the steering wheel. The first press displays a pop-up message in the instrument cluster display for the selected mode and subsequent presses changes the selected mode.

Modes:

- Normal – Developed to complement vehicle response during daily driving.
- Sport – Slightly less assist and damping for improved steering feel during spirited driving.

- Comfort – Slightly more assist for driver preference and daily driving ease.
- Off-road – Similar assist to Normal with added damping for improved control during off-road driving.

After selecting the desired setting, you may feel a soft feedback bump in the steering wheel when the changeover occurs.

Note: If you disconnect or remove the battery, the steering system defaults to normal.

Selecting a Suspension Mode



To change the suspension feel, press the button on the steering wheel. The first press displays a pop-up message in the instrument cluster display for the selected mode and subsequent presses changes the selected mode.

Modes:

- Normal – Default factory setting.
- Sport – Slightly stiffer suspension with emphasis on handling and control.
- Off-road – Maximizes shock performance in extreme off-road environments.

Selecting an Exhaust Mode



To change the exhaust sound, press the button on the steering wheel. The first press displays a pop-up message in the instrument cluster display for the selected mode and subsequent presses changes the selected mode.

Modes:

- Normal – Default setting provides a balance of comfort and feedback.
- Sport – Slightly louder than normal for spirited driving.

Drive Mode Control

- Baja – Loudest setting for off-road use only. Maximum exhaust noise under all driving conditions.
- Quiet – Quietest setting for maximum comfort under all driving conditions.

MyMode



You can use MyMode to create one custom vehicle configuration based on the current state of your vehicle.

When you have your vehicle configured to your desired settings, you can press and hold the button for a few seconds to save as MyMode.

Double-pressing the button activates your saved MyMode.

You can check the saved MyMode settings with a single press of the button.

You can save the following settings as MyMode:

- Drive mode.
- Steering mode.
- Suspension mode.
- Exhaust mode.
- Four-wheel drive mode.
- Stop and start on or off.
- Rear electronic locking differential on or off.

Note: MyMode can only be set with configurations that are available for each drive mode. See **Drive Modes** (page 352).

Note: You can save or view MyMode at any time, regardless of your vehicle's speed or transmission selection, as long as your vehicle is running and it meets system conditions.

Note: When activating MyMode, your vehicle must meet all preconditions for the drive mode and various settings before it activates. A message appears if it does not meet system conditions.

DRIVE MODES

BAJA - RAPTOR



For high speed off-road driving, Baja mode optimizes the throttle control for better response and torque delivery.

Four-wheel drive high is the default four-wheel drive mode. Four-wheel drive auto is not available in baja mode.

Off-road is the default steering and suspension modes. All steering and suspension modes are available.

Baja is the default exhaust mode. All exhaust modes are available.

The system tunes the engine and transmission controls to baja mode.

The system tunes the stability and traction controls to baja mode.

The electronic locking differential is available at all speeds in four-wheel drive. See **Switching the Electronic Locking Differential On and Off** (page 280).

Note: Using baja mode on dry, hard surfaces could produce some vibration, driveline bind up, and potential excessive tire and vehicle wear depending on the four-wheel drive mode selection.

Drive Mode Control

DEEP SNOW/SAND - 4X4



For off-road driving on soft, dry sand or deep snow. This mode optimizes accelerator pedal response, traction and stability controls to help maintain forward momentum. If your vehicle becomes stuck in deep conditions, use this mode to help get unstuck.

Four-wheel drive high is the default four-wheel drive mode. Four-wheel drive low is selectable in deep snow/sand mode.

The electronic locking differential engages when you select this mode at any speed, and you can disengage it at any time using the button. See **Switching the Electronic Locking Differential On and Off** (page 280).

Note: Do not use this mode when driving on pavement or packed snow. This could cause driveline bind up and damage the system depending on the four-wheel drive mode selection. See **Four-Wheel Drive** (page 269).

ECO - 4X4



For efficient driving. This mode helps deliver maximum fuel efficiency and helps to increase driving range.

Two-wheel drive high is the default four-wheel drive mode. Four-wheel drive low is not available in eco mode.

The electronic locking differential is available below 25 mph (40 km/h). See **Switching the Electronic Locking Differential On and Off** (page 280).

ECO - 4X2



For efficient driving. This mode helps deliver maximum fuel efficiency and helps to increase driving range.

The electronic locking differential is available below 25 mph (40 km/h). See **Switching the Electronic Locking Differential On and Off** (page 280).

MUD/RUTS - 4X4



For off-road driving. This mode enhances vehicle performance to traverse muddy, rutted or uneven terrains.

Four-wheel drive high is the default four-wheel drive mode. Four-wheel drive low is selectable in mud/rut mode.

The electronic locking differential engages when you select this mode at any speed, and you can disengage it at any time using the button. See **Switching the Electronic Locking Differential On and Off** (page 280).

Note: Do not use this mode when driving on pavement or packed snow. This could cause driveline bind up and damage the system depending on the four-wheel drive mode selection. See **Four-Wheel Drive** (page 269).

NORMAL - RAPTOR



For everyday driving. This mode is the perfect balance of excitement, comfort and convenience. This is the default mode after each ignition cycle.

Two-wheel drive high is the default four-wheel drive mode. All four-wheel drive modes are selectable when in normal mode.

Normal is the default steering, suspension, and exhaust modes. Off-road steering mode is not available. All suspension and exhaust modes are available.

The system tunes the engine and transmission controls to normal mode.

Drive Mode Control

The system tunes the stability and traction controls to normal mode.

The electronic locking differential is available below 25 mph (40 km/h) in four-wheel drive. See **Switching the Electronic Locking Differential On and Off** (page 280).

NORMAL - 4X4



For everyday driving. This mode is the perfect balance of excitement, comfort and convenience. This is the default mode after each ignition cycle.

Two-wheel drive high is the default four-wheel drive mode. All four-wheel drive modes are selectable when in normal mode.

The electronic locking differential is available below 25 mph (40 km/h). See **Switching the Electronic Locking Differential On and Off** (page 280).

NORMAL - 4X2



For everyday driving. This mode is the perfect balance of excitement, comfort and convenience. This is the default mode after each ignition cycle.

The electronic locking differential is available below 25 mph (40 km/h). See **Switching the Electronic Locking Differential On and Off** (page 283).

OFF-ROAD - RAPTOR



For off-road driving through sand, loose gravel, mud or mixed off-road terrain. This mode optimizes accelerator pedal response, traction and stability controls in order to enhance vehicle performance in off-road environments. If your vehicle becomes stuck in deep conditions, this mode may assist with helping to get unstuck.

Four-wheel drive high is the default four-wheel drive mode. Four-wheel drive low is selectable in off-road mode.

Comfort is the default steering mode. All steering modes are available.

Off-road is the default suspension mode. All suspension modes are available.

Sport is the default exhaust mode. All exhaust modes are available.

The system tunes the engine and transmission control to off-road mode.

The system tunes the stability and traction control to off-road mode.

The electronic locking differential engages when you select this mode at any speed, and you can disengage it at any time using the button. See **Switching the Electronic Locking Differential On and Off** (page 280).

Note: *Do not use this mode when driving on pavement or packed snow. This could cause driveline bind up and damage the system depending on the four-wheel drive mode selection. See **Four-Wheel Drive** (page 269).*

Drive Mode Control

ROCK CRAWL - RAPTOR



For off-road driving and optimum rock-climbing. Rock crawl mode engages the electronic locking differential, optimizes throttle response and adjusts transmission shift points to provide additional control of your vehicle.

Four-wheel drive low is the only four-wheel drive mode available in rock crawl mode.

Comfort is the default steering mode. All steering modes are available.

Off-road is the default suspension mode. All suspension modes are available.

Normal is the default exhaust mode. All exhaust modes are available.

The system tunes the engine and transmission controls to rock crawl mode.

The system tunes the stability and traction controls to rock crawl mode.

The electronic locking differential engages when you select this mode at any speed, and you can disengage it at any time using the button. See **Switching the Electronic Locking Differential On and Off** (page 280).

ROCK CRAWL - 4X4



For off-road driving and optimum rock-climbing. Rock crawl mode engages the electronic locking differential, optimizes throttle response and adjusts transmission shift points to provide additional control of your vehicle.

Four-wheel drive low is the only four-wheel drive mode available in rock crawl mode.

The electronic locking differential engages when you select this mode at any speed, and you can disengage it at any time using the button. See **Switching the Electronic Locking Differential On and Off** (page 280).

SLIPPERY - 4X4, VEHICLES WITH: 2-SPEED TORQUE ON DEMAND



For less than ideal road conditions such as snow or ice covered roads. Use this mode for crossing terrain where loose or slippery materials cover a firm surface. Slippery mode lowers throttle response and optimizes shifting for slippery surfaces.

Four-wheel drive auto is the default four-wheel drive mode. Two-wheel drive high is not available in slippery mode.

The electronic locking differential is available below 25 mph (40 km/h). See **Switching the Electronic Locking Differential On and Off** (page 280).

Note: *Do not use this mode when driving on dry pavement. This could cause driveline bind up and damage the system depending on the four-wheel drive mode selection. See **Four-Wheel Drive** (page 269).*

SLIPPERY - RAPTOR



For less than ideal road conditions such as snow or ice covered roads. Use this mode for crossing terrain where loose or slippery materials cover a firm surface. Slippery mode lowers throttle response and optimizes shifting for slippery surfaces.

Four-wheel drive auto is the default four-wheel drive mode. Two-wheel drive high is not available in slippery mode.

Drive Mode Control

Normal is the default steering, suspension, and exhaust modes. Off-road steering mode is not available. All suspension and exhaust modes are available.

The system tunes the engine and transmission controls to slippery mode.

The system tunes stability and traction controls to slippery mode.

The electronic locking differential is available below 25 mph (40 km/h). See **Switching the Electronic Locking Differential On and Off** (page 280).

Note: Do not use this mode when driving on dry pavement. This could cause driveline bind up and damage the system depending on the four-wheel drive mode selection. See **Four-Wheel Drive** (page 269).

SLIPPERY -4X4, VEHICLES WITH: ELECTRONIC SHIFT-ON-THE-FLY



For less than ideal road conditions such as snow or ice covered roads. Use this mode for crossing terrain where loose or slippery materials cover a firm surface. Slippery mode lowers throttle response and optimizes shifting for slippery surfaces.

Four-wheel drive high is the default four-wheel drive mode. All four-wheel drive modes are selectable in slippery mode.

The electronic locking differential is available below 25 mph (40 km/h). See **Switching the Electronic Locking Differential On and Off** (page 280).

Note: Do not use this mode when driving on dry pavement. This could cause driveline bind up and damage the system depending on the four-wheel drive mode selection. See **Four-Wheel Drive** (page 269).

SLIPPERY - 4X2



For less than ideal road conditions such as snow or ice covered roads. Use this mode for crossing terrain where loose or slippery materials cover a firm surface. Slippery mode lowers throttle response and optimizes shifting for slippery surfaces.

The electronic locking differential is available below 25 mph (40 km/h). See **Switching the Electronic Locking Differential On and Off** (page 283).

Note: Do not use this mode when driving on dry pavement. This could cause driveline bind up and damage the system depending on the four-wheel drive mode selection. See **Four-Wheel Drive** (page 269).

SPORT - 4X4, VEHICLES WITH: 2-SPEED TORQUE ON DEMAND



For sporty driving with improved performance handling and response. This mode increases accelerator pedal response and provides a sportier steering feel. The powertrain system holds onto lower gears longer, helping your vehicle accelerate faster.

Four-wheel drive auto is the default four-wheel drive mode. Four-wheel drive low is not available in sport mode.

The system tunes the steering and suspension to provide a more connected and spirited driving experience.

The electronic locking differential is available below 25 mph (40 km/h). See **Switching the Electronic Locking Differential On and Off** (page 280).

Drive Mode Control

SPORT - RAPTOR



For sporty driving with improved performance handling and response. This mode increases accelerator pedal response and provides a sportier steering feel. The powertrain system holds onto lower gears longer, helping your vehicle accelerate faster.

Two-wheel drive high is the default four-wheel drive mode. Four-wheel drive low is not available in sport mode.

Sport is the default steering, suspension, and exhaust modes. Off-road steering mode is not available. All suspension and exhaust modes are available.

The system tunes the engine and transmission controls to sport mode.

The system tunes the stability and traction controls to normal mode.

The electronic locking differential is available below 25 mph (40 km/h). See **Switching the Electronic Locking Differential On and Off** (page 280).

SPORT - 4X4, VEHICLES WITH: ELECTRONIC SHIFT-ON-THE-FLY



For sporty driving with improved performance handling and response. This mode increases accelerator pedal response and provides a sportier steering feel. The powertrain system holds onto lower gears longer, helping your vehicle accelerate faster.

Two-wheel drive high is the default four-wheel drive mode. Four-wheel drive low is not available in sport mode.

The system tunes the steering and suspension to provide a more connected and spirited driving experience.

The electronic locking differential is available below 25 mph (40 km/h). See **Switching the Electronic Locking Differential On and Off** (page 280).

SPORT - 4X2



For sporty driving with improved performance handling and response. This mode increases accelerator pedal response and provides a sportier steering feel. The powertrain system holds onto lower gears longer, helping your vehicle accelerate faster.

The system tunes the steering and suspension to provide a more connected and spirited driving experience.

The electronic locking differential is available below 25 mph (40 km/h). See **Switching the Electronic Locking Differential On and Off** (page 283).

TOW/HAUL - RAPTOR



For improved transmission operation when towing a trailer or a heavy load. This mode moves upshifts to higher engine speeds to reduce the frequency of transmission shifting. This mode also provides engine braking in all forward gears, which slows your vehicle and assists you in controlling your vehicle when descending a slope. The amount of downshift braking provided varies based on the amount you press the brake pedal.

All four-wheel drive modes are selectable when in tow/haul mode. This mode does not default to a certain four-wheel drive mode and maintains the previous selection.

Normal is the default steering and exhaust modes. Off-road steering mode is not available. All exhaust modes are available.

Drive Mode Control

Sport is the default suspension mode. Normal suspension mode is available. Off-road suspension mode is not available.

The system tunes the engine and transmission controls to tow mode.

The system tunes the stability and traction controls to normal mode.

The electronic locking differential is available below 25 mph (40 km/h). See

Switching the Electronic Locking Differential On and Off (page 280).

TOW/HAUL - 4X4



For improved transmission operation when towing a trailer or a heavy load. This mode moves upshifts to higher engine speeds to reduce the frequency of transmission shifting. This mode also provides engine braking in all forward gears, which slows your vehicle and assists you in controlling your vehicle when descending a slope. The amount of downshift braking provided varies based on the amount you press the brake pedal.

All four-wheel drive modes are selectable in tow/haul mode. This mode does not default to a certain four-wheel drive mode and maintains the previous selection.

The system tunes the steering and suspension to enhance driving comfort when towing or carrying heavy loads.

The electronic locking differential is available below 25 mph (40 km/h). See

Switching the Electronic Locking Differential On and Off (page 280).

TOW/HAUL - 4X2



For improved transmission operation when towing a trailer or a heavy load. This mode moves upshifts to higher engine speeds to reduce the frequency of transmission shifting. This mode also provides engine braking in all forward gears, which slows your vehicle and assists you in controlling your vehicle when descending a slope. The amount of downshift braking provided varies based on the amount you press the brake pedal.

The system tunes the steering and suspension to enhance driving comfort when towing or carrying heavy loads.

The electronic locking differential is available below 25 mph (40 km/h). See

Switching the Electronic Locking Differential On and Off (page 283).

TRAIL - 4X2



Trail mode is for off-road driving on muddy, rutted, soft or uneven terrain. This mode lowers throttle response to increase wheel spin to keep the tires clear and to prevent getting stuck.

The electronic locking differential is available below 25 mph (40 km/h). See

Switching the Electronic Locking Differential On and Off (page 283).

Drive Mode Control

DRIVE MODE CONTROL – TROUBLESHOOTING



Some drive modes reduce traction and stability control performance and the indicator illuminates in the instrument cluster.

DRIVE MODE CONTROL – WARNING LAMPS

DRIVE MODE CONTROL – INFORMATION MESSAGES

| Message | Action |
|---|---|
| Selected 4x4 Mode Not Available in Current Drive Mode | You have selected a four-wheel drive mode that is not available in the current drive mode. Select an available four-wheel drive mode. |

Drive Mode Control

DRIVE MODE CONTROL – FREQUENTLY ASKED QUESTIONS

Why did the system default to normal mode?

If a mode is unavailable due to a system fault, it defaults to normal mode and the driveline settings remain the same as prior to the system fault.

Lane Keeping System (If Equipped)

WHAT IS THE LANE KEEPING SYSTEM

The lane keeping system alerts you by providing temporary steering assistance or steering wheel vibration when it detects an unintended lane departure.

HOW DOES THE LANE KEEPING SYSTEM WORK

The lane keeping system uses a forward looking camera mounted on the windshield to monitor vehicle movement within the travel lane.

When the camera detects a drift out of the travel lane, the lane keeping system alerts the driver by vibrating the steering wheel, or aids the driver by providing a small steering input to move the vehicle back into the travel lane.

The driver can select one of three modes:

- Alert (If Equipped)
- Aid
- Alert + Aid

LANE KEEPING SYSTEM PRECAUTIONS

 **WARNING:** You are responsible for controlling your vehicle at all times. The system is designed to be an aid and does not relieve you of your responsibility to drive with due care and attention. Failure to follow this instruction could result in the loss of control of your vehicle, personal injury or death.

 **WARNING:** The system will not operate if the sensor cannot track the road lane markings.

 **WARNING:** The sensor may incorrectly track lane markings as other structures or objects. This can result in a false or missed warning.

 **WARNING:** In cold and severe weather conditions the system may not function. Rain, snow and spray can all limit sensor performance.

 **WARNING:** The system may not operate properly if the sensor is blocked. Keep the windshield free from obstruction.

 **WARNING:** If damage occurs in the immediate area surrounding the sensor, have your vehicle checked as soon as possible.

 **WARNING:** The system may not correctly operate if your vehicle is fitted with a suspension kit not approved by us.

 **WARNING:** Large contrasts in outside lighting can limit sensor performance.

LANE KEEPING SYSTEM LIMITATIONS

The lane keeping system only operates when the vehicle speed is greater than 40 mph (64 km/h).

The system works when the camera can detect at least one lane marking.

Note: When you select Aid or Alert and Aid mode and the system detects no steering activity for a short period of time, the system alerts you to put your hands on the steering wheel. The system may detect a light grip or touch on the steering wheel as hands-off driving.

Lane Keeping System (If Equipped)

The lane keeping system may not correctly operate in any of the following conditions:

- The lane keeping system does not detect at least one lane marking.
- You switch the turn signal on.
- You apply direct steering, accelerate fast or brake hard.
- The vehicle speed is less than 40 mph (64 km/h).
- The anti-lock brake, stability control or traction control system activates.
- The lane is too narrow.
- Something is obscuring the camera or it is unable to detect the lane markings due to environment, traffic or vehicle conditions.
- Entering or exiting a tight curve when driving at high speeds.

The lane keeping system may not correct lane positioning in any of the following conditions:

- High winds.
- Uneven road surfaces.
- Heavy or uneven loads.
- Incorrect tire pressure.

SWITCHING THE LANE KEEPING SYSTEM ON AND OFF



To activate the lane keeping system, press the button on the steering wheel.

To deactivate the lane keeping system, press the button again.

Note: When switching the system on or off a message appears in the information and entertainment display to show the status.

Note: The system stores the on or off setting until manually changed, unless it detects a MyKey™. If the system detects a MyKey™, it defaults to the last setting for that MyKey™.

Note: If the system detects a MyKey™, pressing the button does not affect the on or off status of the system. You can only change the mode and intensity settings.

SWITCHING THE LANE KEEPING SYSTEM MODE

The lane keeping system has different settings that you can view or adjust using the information display.

The system stores the last known selection for each of these settings. You do not need to readjust your settings each time you switch on the system.

To change the lane keeping system mode, use the touchscreen:

1. Press **Features** on the touchscreen.
2. Press **Driver Assistance**.
3. Press **Lane-Keeping System**.
4. Press **Lane-Keeping Mode**.
5. Select a mode.

Note: The system remembers the last setting when you start your vehicle. If the system detects a MyKey™, it defaults to the last setting for that MyKey™.

ALERT MODE

WHAT IS ALERT MODE

Alert mode vibrates the steering wheel when it detects an unintended lane departure.

Lane Keeping System (If Equipped)

HOW DOES ALERT MODE WORK

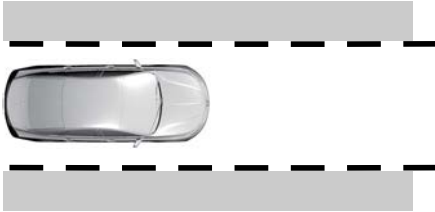

When in alert mode, the lane keeping system alerts you by vibrating the steering wheel. The intensity of the vibration is set through the lane keeping system menu.

ADJUSTING THE STEERING WHEEL VIBRATION INTENSITY

To change the steering wheel vibration intensity, use the touchscreen:

1. Press **Features** on the touchscreen.
2. Press **Driver Assistance**.
3. Press **Lane-Keeping System**.
4. Press **Lane-Keeping Intensity**.
5. Select an intensity setting.

AID MODE

WHAT IS AID MODE

Aid mode provides temporary steering assistance toward the center of the lane.

HOW DOES AID MODE WORK

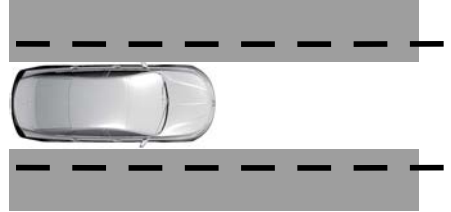

The lane keeping system aids you when an unintentional lane departure occurs. The system provides a small steering input to move the vehicle towards the center of the lane.

ALERT AND AID MODE

WHAT IS ALERT AND AID MODE

Alert and aid mode uses multiple features to keep you in your lane. The system first provides a small steering input to bring your vehicle back towards the center of the lane. If your vehicle moves too far out of the center of the lane the system alerts you with vibration in the steering wheel.

Lane Keeping System (If Equipped)

HOW DOES ALERT AND AID MODE WORK

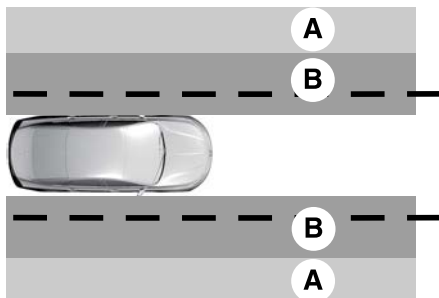

- A Alert.
- B Aid.

The lane keeping system detects a lane departure and provides aid when the vehicles enters **B** and applies the additional alert warning if **A** is entered.

LANE KEEPING SYSTEM INDICATORS

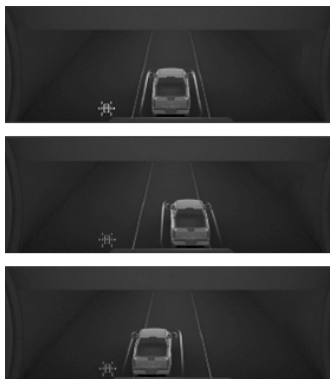

If you switch the lane keeping system on, a graphic with lane markings appears in the information display.

When you switch the system off, the lane marking graphics do not display.

Note: *The overhead vehicle graphic may still display if adaptive cruise control is enabled.*

While the lane keeping system is on, the color of the lane markings change to indicate the system status.

| Gray | Green | Yellow | Red |
|--|---|--|---|
| Indicates that the system is temporarily unavailable to provide a warning or intervention on the indicated side. | Indicates that the system is available or ready to provide a warning or intervention on the indicated side. | Indicates that the system is providing or has just provided a lane keeping aid intervention. | Indicates that the system is providing or has just provided a lane keeping alert warning. |

Lane Keeping System (If Equipped)

LANE KEEPING SYSTEM – TROUBLESHOOTING

LANE KEEPING SYSTEM – INFORMATION MESSAGES

| Message | Action |
|--|--|
| Lane Keeping Sys. Malfunction Service Required | The system has malfunctioned. Have your vehicle checked as soon as possible. |
| Front Camera Temporarily Not Available | The system has detected a condition that has caused the system to be temporarily unavailable. |
| Front Camera Low Visibility Clean Screen | The system has detected a condition that requires you to clean the windshield in order for it to operate properly. |
| Front Camera Malfunction Service Required | The system has malfunctioned. Have your vehicle checked as soon as possible. |
| Keep Hands on Steering Wheel | The system requests that you keep your hands on the steering wheel. |

Lane Keeping System (If Equipped)

LANE KEEPING SYSTEM – FREQUENTLY ASKED QUESTIONS

| Why is the feature not available (lane markings are gray) when I can see the lane markings on the road? |
|--|
| Your vehicle speed is less than 40 mph (65 km/h). |
| The sun is shining directly into the camera lens. |
| A quick intentional lane change has occurred. |
| Your vehicle stays too close to the lane markings for an extended interval of time. |
| Driving at high speeds in curves. |
| The last alert warning or aid intervention occurred a short time ago. |
| Ambiguous lane markings, for example, in construction zones. |
| Rapid transition from light to dark, or from dark to light. |
| Sudden offset in lane markings. |
| ABS or AdvanceTrac™ is active. |
| There is a camera blockage due to dirt, grime, fog, frost or water on the windshield. |
| You are driving too close to the vehicle in front of you. |
| Transitioning between no lane markings to lane markings, or vice versa. |
| There is standing water on the road. |
| Faint lane markings, for example, partial yellow lane markings on concrete roads. |
| Lane width is too narrow or too wide. |
| You have not calibrated the camera after a windshield replacement. |
| Driving on tight or on uneven roads. |

Lane Keeping System (If Equipped)

| Why does the vehicle not come back toward the middle of the lane, as expected, in the Aid, or Aid + Alert mode? |
|--|
| High cross winds are present. |
| There is a large road crown. |
| Rough roads, grooves or shoulder drop-offs. |
| Heavy, uneven loading of the vehicle or improper tire inflation pressure. |
| You changed the tires or modified the suspension. |

Blind Spot Information System (If Equipped)

WHAT IS BLIND SPOT INFORMATION SYSTEM

Blind spot information system detects vehicles that may have entered the blind spot zone.

HOW DOES BLIND SPOT INFORMATION SYSTEM WORK

Blind spot information system uses sensors on both sides of your vehicle, detecting rearward from the exterior mirrors to approximately 13 ft (4 m) beyond the rear bumper. The detection area extends to approximately 59 ft (18 m) beyond the rear bumper when the vehicle speed is greater than 30 mph (48 km/h) to alert you of faster approaching vehicles.

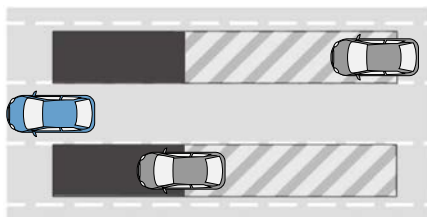

BLIND SPOT INFORMATION SYSTEM PRECAUTIONS



WARNING: Do not use the blind spot information system as a replacement for using the interior and exterior mirrors or looking over your shoulder before changing lanes. The blind spot information system is not a replacement for careful driving.



WARNING: The system may not operate properly during severe weather conditions, for example snow, ice, heavy rain and spray. Always drive with due care and attention. Failure to take care may result in a crash.

Note: *Blind spot information system does not prevent contact with other vehicles. It does not detect parked vehicles, pedestrians, animals or other infrastructure.*

BLIND SPOT INFORMATION SYSTEM LIMITATIONS

Blind spot information system does not operate in park (P) or reverse (R).

The system may not alert you if a vehicle quickly passes through the detection zone.

BLIND SPOT INFORMATION SYSTEM REQUIREMENTS

Blind spot information system turns on when all the following occur:

- You start your vehicle.
- You shift into drive (D).
- The vehicle speed is greater than 6 mph (10 km/h).

SWITCHING BLIND SPOT INFORMATION SYSTEM ON AND OFF

To switch blind spot information system on or off, use the touchscreen:

1. Press **Features** on the touchscreen.
2. Press **Driver Assistance**.
3. Press **Blind Spot Information System**.
4. Switch the feature on or off.

Blind Spot Information System (If Equipped)

When you switch blind spot information system off, a warning lamp illuminates and a message displays. When you switch the system on or off, the alert indicators flash twice.

Note: *The system remembers the last setting when you start your vehicle.*

To permanently switch the system off, contact an authorized dealer.

LOCATING THE BLIND SPOT INFORMATION SYSTEM SENSORS

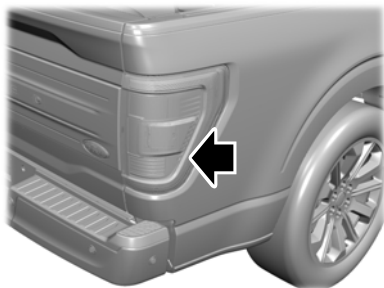

The sensors are inside the brake lamp on both sides of your vehicle.

Note: *Keep the sensors free from snow, ice and large accumulations of dirt.*

Note: *Do not cover the sensors with bumper stickers, repair compound or other objects.*

Note: *Bike and cargo racks could cause false alerts due to obstruction of the sensor. We recommend switching the feature off when using a bike or cargo rack.*

Note: *Blocked sensors may affect system accuracy.*

If the sensors become blocked, a message appears in the instrument cluster display. See **Blind Spot Information System – Information Messages** (page 371). The alert indicators illuminate but the system does not alert you.

BLIND SPOT INFORMATION SYSTEM WITH TRAILER COVERAGE (IF EQUIPPED)

WHAT IS BLIND SPOT INFORMATION SYSTEM WITH TRAILER COVERAGE

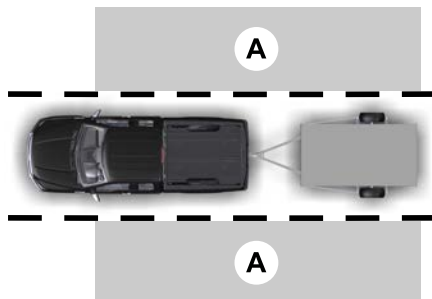

Blind spot information system detects vehicles that may have entered the blind spot zone. The detection area is on both sides your vehicle and trailer, extending rearward from the exterior mirrors to the end of your trailer.

BLIND SPOT INFORMATION SYSTEM WITH TRAILER COVERAGE LIMITATIONS

Trailer coverage only supports conventional trailers. The system turns off if you select a fifth wheel trailer type.

Blind Spot Information System (If Equipped)

Make sure the trailer width is less than or equal to 8.5 ft (2.6 m) and the length is less than 33 ft (10.1 m). If you input values higher, the system turns off.

Some trailers could cause a slight change in system performance:

- Large box trailers could cause false alerts to occur when driving next to infrastructures or near parked cars. A false alert could also occur while making a 90-degree turn.
- Trailers that have a width greater than 8.5 ft (2.6 m) at the front and have a total length greater than 20 ft (6 m) could cause delayed alerts when a vehicle is passing at high speeds.
- Box trailers that have a width greater than 8.5 ft (2.6 m) at the front could cause early alerts when you pass a vehicle.
- Clam shell or v-nose box trailers with a width greater than 8.5 ft (2.6 m) at the front could cause delayed alerts when a vehicle traveling the same speed as your vehicle merges lanes.

SETTING A TRAILER LENGTH

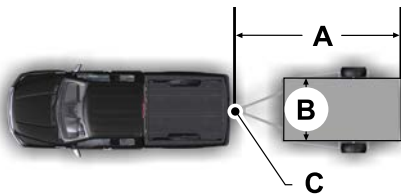

- A Trailer length.
- B Trailer width.
- C Trailer hitch ball.

You can set-up a trailer to work with the blind spot information system through the touchscreen. When setting up a trailer, a sequence of screens appear asking for trailer information.

1. Select type of trailer screen - conventional, fifth wheel or gooseneck.

Note: *The system only supports conventional trailers.*

2. Do you want to set up blind spot with trailer screen? If no, the system turns off. If yes, the menu goes to the next screen.
3. Is the width less than 9 ft (2.7 m) and length less than 33 ft (10.1 m)? If no, the system turns off. If yes, the menu goes to the next screen.
4. Trailer width measurement. Measure the width at the front of the trailer. It is not measured at the widest point of the trailer. The maximum width at the front of the trailer the system can support is 8.5 ft (2.6 m).

Note: *You do not need to enter an exact trailer width measurement. You only need to confirm that the width of the trailer is less than 9 ft (2.7 m).*

5. Trailer length measurement. The trailer length is the distance between the trailer hitch ball and the rear of the trailer. The maximum length that the system can support is 33 ft (10.1 m).
6. Enter the length of trailer. The default setting is 18 ft (5.5 m). Toggling up or down using the menu buttons increases or decreases the measurement by 3 ft (1 m). Select a length that is equal to or within 3 ft (1 m) of the actual measured length. For example, if the actual measure length is 25 ft (7.5 m), toggle the length in the menu to 27 ft (8.2 m). The system setup saves when you enter the length of the trailer.

Blind Spot Information System (If Equipped)

Note: If the trailer is a bike rack or cargo rack with electrical lighting, enter a length of 3 ft (1 m). Cross traffic alert remains on for trailers with a length of 3 ft (1 m) or less.

Note: The system requires proper measurement and measure entry to function properly.

SELECTING A TRAILER

When you connect a trailer to your vehicle, the trailer set up menu appears in the touchscreen. This menu allows you to set up a new trailer or choose from a previously set up trailer. A warning message appears and the system turns off if you do not choose or add a new trailer.

Note: The warning message may not appear until your vehicle reaches 22 mph (35 km/h).

BLIND SPOT INFORMATION SYSTEM INDICATORS



When blind spot information system detects a vehicle, an alert indicator illuminates in the exterior mirror on the side the approaching vehicle is coming from. If you turn the turn signal on for that side of your vehicle, the alert indicator flashes.

BLIND SPOT INFORMATION SYSTEM – TROUBLESHOOTING

BLIND SPOT INFORMATION SYSTEM – INFORMATION MESSAGES

| Message | Action |
|--|---|
| Blind Spot System Fault | A fault with the system has occurred. Have your vehicle checked as soon as possible. |
| Blind Spot Not Available Sensor Blocked See Manual | Something is blocking the sensors. Clean the sensors. |
| Blind Spot Alert Deactivated Trailer Attached | The system automatically turns off and displays this message when you connect a trailer to the vehicle that does not have a trailer blind spot system or when you switch the trailer blind spot system off through the touchscreen. |

Cross Traffic Alert (If Equipped)

WHAT IS CROSS TRAFFIC ALERT

The system alerts you of vehicles approaching from the sides behind your vehicle when you shift into reverse (R).

HOW DOES CROSS TRAFFIC ALERT WORK

Cross traffic alert detects vehicles that approach at a speed between 4–37 mph (6–60 km/h). Coverage decreases when the sensors are partially, mostly or fully obstructed.

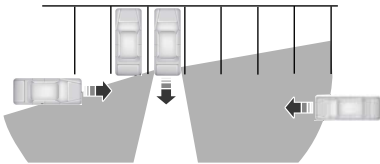

The sensor on the left-hand side is only partially obstructed and zone coverage on the right-hand side is maximized.

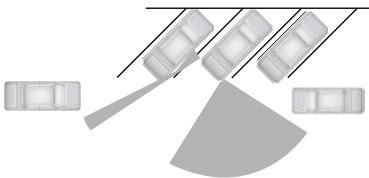

Zone coverage also decreases when parking at narrow angles. The sensor on the left-hand side is mostly obstructed and zone coverage on that side is severely reduced.

Note: *Slowly reversing helps increase the coverage area and effectiveness.*

CROSS TRAFFIC ALERT PRECAUTIONS

WARNING: Do not use the cross traffic alert system as a replacement for using the interior and exterior mirrors or looking over your shoulder before reversing out of a parking space. The cross traffic alert system is not a replacement for careful driving.

WARNING: The system may not operate properly during severe weather conditions, for example snow, ice, heavy rain and spray. Always drive with due care and attention. Failure to take care may result in a crash.

CROSS TRAFFIC ALERT LIMITATIONS

The system may not correctly operate when any of the following occur:

- Something is blocking the sensors.
- Adjacently parked vehicles or objects are obstructing the sensors.
- Vehicles approach at speeds less than 4 mph (6 km/h) or greater than 37 mph (60 km/h).
- Your vehicle speed is greater than 7 mph (12 km/h).
- You reverse out of an angled parking space.

Cross Traffic Alert (If Equipped)

Cross Traffic Alert Limitations with a Trailer Attached

The system remains on when you attach a trailer in vehicles with blind spot information system with trailer tow under the following conditions:

- You connect a trailer.
- The trailer is a bike rack or cargo rack with a maximum length of 3 ft (1 m).
- You set the trailer length to 3 ft (1 m) in the instrument cluster display.

Note: The system may not correctly operate when towing a trailer. For vehicles with an approved trailer tow module and tow bar, the system turns off when you attach a trailer. For vehicles with an aftermarket trailer tow module or tow bar, we recommend that you switch the system off when you attach a trailer.

SWITCHING CROSS TRAFFIC ALERT ON AND OFF

To switch cross traffic alert on or off use the touchscreen.

1. Press **Features** on the touchscreen.
2. Press **Driver Assistance**.
3. Switch **Cross Traffic Alert** on or off.

Note: The system switches on every time you switch the ignition on. To permanently switch the system off, contact an authorized dealer.

LOCATING THE CROSS TRAFFIC ALERT SENSORS



The sensors are inside the brake lamp on both sides of your vehicle.

Note: Keep the sensors free from snow, ice and large accumulations of dirt.

Note: Do not cover the sensors with bumper stickers, repair compound or other objects.

Note: Blocked sensors may affect system accuracy.

If something is blocking the sensors, a message may appear in the information display when you shift into reverse (R).

Note: Bike and cargo racks could cause false alerts due to obstruction of the sensor. We recommend switching the feature off when using a bike or cargo rack.

CROSS TRAFFIC ALERT INDICATORS



When the cross traffic alert detects an approaching vehicle, a tone sounds, a warning lamp illuminates in the relevant exterior mirror and arrows appear in the information display to show which side the vehicle is approaching from.

Cross Traffic Alert (If Equipped)

If the system malfunctions, a warning lamp illuminates in the instrument cluster and a message appears in the information display. Have your vehicle checked as soon as possible.

Note: *If arrows do not display, a message appears in the information display.*

Note: *In some conditions, the system could alert you, even when there is nothing in the detection zone, for example a vehicle passing further away from your vehicle.*

CROSS TRAFFIC ALERT – TROUBLESHOOTING

CROSS TRAFFIC ALERT – INFORMATION MESSAGES

| Message | Action |
|--|---|
| Cross Traffic Alert | Displays instead of indication arrows when the system detects a vehicle. Check for approaching traffic. |
| Cross Traffic Not Available Sensor Blocked See Manual | Indicates blocked cross traffic alert system sensors. Clean the sensors. If the message continues to appear, have your vehicle checked as soon as possible. |
| Cross Traffic System Fault | The system has malfunctioned. Have your vehicle checked as soon as possible. |
| Cross Traffic Alert Deactivated Trailer Attached | Displays if you attach a trailer to your vehicle. |

Pre-Collision Assist (If Equipped)

WHAT IS PRE-COLLISION ASSIST

Pre-collision assist detects and warns of approaching hazards in the roadway. The system provides multiple levels of assistance to help avoid a collision if your vehicle is rapidly approaching another stationary vehicle, a vehicle traveling in the same direction as yours, or a pedestrian or cyclist within your driving path.

HOW DOES PRE-COLLISION ASSIST WORK

The system warns the driver of potential hazards by providing three levels of assistance.

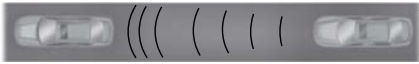

If your vehicle is rapidly approaching potential hazards the system provides the following levels of functionality:

1. Alert.
2. Brake Support.
3. Automatic Emergency Braking.



Alert: When active, a flashing visual warning appears and an audible warning tone sounds.

Brake Support: The system is designed to help reduce the impact speed by preparing the brakes for rapid braking. The system does not automatically apply the brakes. If you press the brake pedal, the system could apply additional braking up to maximum braking force, even if you lightly press the brake pedal.

Automatic Emergency Braking: Automatic emergency braking may activate if the system determines that a collision is imminent.

Note: If you perceive pre-collision assist alerts as being too frequent or disturbing, then you can reduce the alert sensitivity, although the manufacturer recommends using the highest sensitivity setting where possible. Setting lower sensitivity would lead to fewer and later system warnings.

Each system has various levels of detection capabilities. See **Pre-Collision Assist Limitations** (page 376).

PRE-COLLISION ASSIST PRECAUTIONS



WARNING: You are responsible for controlling your vehicle at all times. The system is designed to be an aid and does not relieve you of your responsibility to drive with due care and attention. Failure to follow this instruction could result in the loss of control of your vehicle, personal injury or death.



WARNING: The system does not detect vehicles moving in a different direction or animals. Apply the brakes when necessary. Failure to follow this instruction could result in the loss of control of your vehicle, personal injury or death.





WARNING: The system does not operate during hard acceleration or steering. Failure to take care may lead to a crash or personal injury.



WARNING: The system may fail or operate with reduced function during cold and severe weather conditions. Snow, ice, rain, spray and fog can adversely affect the system. Keep the front camera and radar free of snow and ice. Failure to take care may result in the loss of control of your vehicle, serious personal injury or death.

Pre-Collision Assist (If Equipped)

 **WARNING:** Take additional care if your vehicle is heavily loaded or you are towing a trailer. These conditions could result in reduced performance of this system. Failure to follow this instruction could result in the loss of control of your vehicle, personal injury or death.

 **WARNING:** The system cannot help prevent all crashes. Do not rely on this system to replace driver judgment and the need to maintain a safe distance and speed.

 **WARNING:** In situations where the vehicle camera has limited detection capability, this may reduce system performance. These situations include but are not limited to direct or low sunlight, vehicles at night without tail lights, unconventional vehicle types, pedestrians with complex backgrounds, running pedestrians, partly obscured pedestrians, or pedestrians that the system cannot distinguish from a group. Failure to take care may result in the loss of control of your vehicle, serious personal injury or death.

PRE-COLLISION ASSIST LIMITATIONS

Pre-collision assist depends on the detection ability of its camera and sensors. Any obstructions or damage to these areas can limit detection or prevent the system from functioning. See **Locating the Pre-Collision Assist Sensors** (page 378).

The system is active at speeds above 3 mph (5 km/h).

Note: The pre-collision assist system automatically disables when you select four-wheel drive low, manually disable AdvanceTrac™, or select rock crawl mode, if your vehicle comes with it.

Note: Brake support and automatic emergency braking are active at speeds up to 80 mph (130 km/h). If your vehicle has a radar sensor included with adaptive cruise control, then brake support and automatic emergency braking are active up to the maximum speed of your vehicle.

Pedestrian Detection Limitations

Pedestrian detection is active at speeds up to 50 mph (80 km/h).

Pedestrian detection operates optimally when detected hazards are clearly identifiable. System performance may reduce in situations where pedestrians are running, partly obscured, have a complex background, or when the system cannot distinguish pedestrians from a group.

Cyclist Detection Limitations

Cyclist detection is active at speeds up to 50 mph (80 km/h).

Cyclist detection functions optimally when detected hazards are clearly identifiable. System performance may reduce in situations where cyclists are fast-moving, partly obscured, have a complex background, or cannot be distinguished from a group.

Intersection Assist (If Equipped)

If your vehicle comes with a radar sensor included in adaptive cruise control, the pre-collision assist system may operate in a scenario where you are turning across an oncoming vehicle's path. Detection of vehicles driving in an oncoming direction is active if your vehicle is driving at speeds up to 19 mph (30 km/h).

Pre-Collision Assist (If Equipped)

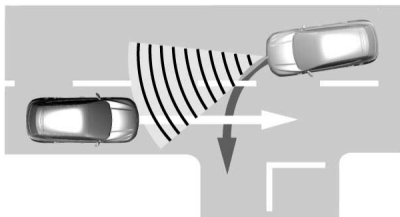

SWITCHING PRE-COLLISION ASSIST ON AND OFF - POLICE RESPONDER

To switch the system on or off, use the touchscreen:

1. Press **Features** on the touchscreen.
2. Press **Driver Assistance**.
3. Press **Pre-Collision Assist**.
4. Switch the feature on or off.



You can switch the entire system off at any time by pressing the button above the touchscreen.

Adjusting the Pre-Collision Assist Settings

You can adjust the following settings by using the touchscreen controls in the pre-collision assist menu:

- Change alert sensitivity to one of three possible settings.
- If required, switch automatic emergency braking on or off.
- If required, switch the entire pre-collision assist feature on or off.

Note: Automatic emergency braking turns on every time you switch the ignition on.

SWITCHING PRE-COLLISION ASSIST ON AND OFF

To switch the system on or off, use the touchscreen:

1. Press **Features** on the touchscreen.
2. Press **Driver Assistance**.
3. Press **Pre-Collision Assist**.
4. Switch the feature on or off.

Adjusting the Pre-Collision Assist Settings

You can adjust the following settings by using the touchscreen controls in the pre-collision assist menu:

- Change alert and distance alert sensitivity to one of three possible settings.
- Switch distance indication and alert on or off.
- If required, switch automatic emergency braking on or off.
- If required, switch the entire pre-collision assist feature on or off.
- If required, switch evasive steering assist on or off.

Note: Automatic emergency braking and evasive steering turn on every time you switch the ignition on.

Note: If your vehicle has a radar sensor, we recommend that you switch the system off if you install a snow plow or similar object in such a way that it may block the radar sensor. Your vehicle remembers the selected setting across key cycles.

Note: If you switch automatic emergency braking off, evasive steering assist switches off.

Pre-Collision Assist (If Equipped)

LOCATING THE PRE-COLLISION ASSIST SENSORS - POLICE RESPONDER



- 1 Camera.

If a message regarding a blocked camera appears in the instrument cluster display, something is obstructing the camera images. With a blocked camera, the system may not function, or performance may reduce. See **Pre-Collision Assist – Information Messages** (page 383).

Note: Proper system operation requires a clear view of the road by the camera. Have any windshield damage in the area of the camera's field of view repaired.

Note: If your vehicle detects excessive heat at the camera or a potential misalignment condition, a message could display in the information display indicating temporary sensor unavailability. When operational conditions are correct, the message deactivates. For example, when the ambient temperature around the sensor decreases or the sensor recalibrates successfully.

LOCATING THE PRE-COLLISION ASSIST SENSORS

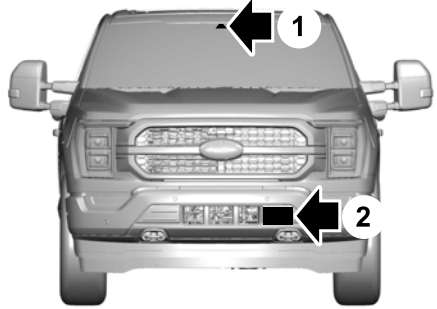

1. Camera.
2. Radar sensor (if equipped).

If a message regarding a blocked sensor or camera appears in the information display, something is obstructing the radar signals or camera images. The radar sensor is behind the fascia cover in the center of the lower grille. With a blocked sensor or camera, the system may not function, or performance may reduce. See **Pre-Collision Assist – Information Messages** (page 383).

Note: Proper system operation requires a clear view of the road by the camera. Have any windshield damage in the area of the camera's field of view repaired.

Note: If something hits the front end of your vehicle or damage occurs and your vehicle has a radar sensor, the radar sensing zone could change. This could cause missed or false vehicle detections. Have your vehicle serviced to have the radar checked for proper coverage and operation.

Pre-Collision Assist (If Equipped)

Note: If your vehicle detects excessive heat at the camera or a potential misalignment condition, a message could display in the information display indicating temporary sensor unavailability. When operational conditions are correct, the message deactivates. For example, when the ambient temperature around the sensor decreases or the sensor recalibrates successfully.

DISTANCE INDICATION

WHAT IS DISTANCE INDICATION

Distance indication displays the gap between your vehicle and the vehicle ahead of you.

Note: The graphic does not display if you switch on cruise control or adaptive cruise control.

| Vehicle Speed | System Sensitivity | Distance Indicator Color | Distance Gap | Time Gap |
|-----------------------|--------------------|--------------------------|----------------------------|---------------------------|
| 62 mph (100 km/h). | Normal. | Blue. | Greater than 82 ft (25 m). | Greater than 0.9 seconds. |
| | | Yellow. | 56–82 ft (17–25 m). | 0.6–0.9 seconds. |
| | | Red. | Less than 56 ft (17 m). | Less than 0.6 seconds. |

Pre-Collision Assist (If Equipped)

SWITCHING DISTANCE INDICATION ON AND OFF

To switch the system on or off, use the touchscreen:

1. Press **Features** on the touchscreen.
2. Press **Driver Assistance**.
3. Press **Pre-Collision Assist**.
4. Switch **Distance Indication** on or off.

DISTANCE INDICATION INDICATOR

The indicator displays the time gap between your vehicle and vehicles traveling in the same direction ahead of you.



DISTANCE ALERT

WHAT IS DISTANCE ALERT

The system alerts you with a warning lamp if the distance to the vehicle ahead is small.

Note: *The warning lamp does not illuminate if cruise control or adaptive cruise control is active.*

Pre-Collision Assist (If Equipped)

ADJUSTING THE SENSITIVITY OF DISTANCE ALERT

To adjust the sensitivity of the system, use the touchscreen:

1. Press **Features** on the touchscreen.
2. Press **Driver Assistance**.
3. Press **Pre-Collision Assist**.
4. Press **Alert Sensitivity**.
5. Select a setting.

AUTOMATIC EMERGENCY BRAKING

WHAT IS AUTOMATIC EMERGENCY BRAKING

Automatic emergency braking may activate if the system determines that a collision is imminent. The system may help reduce impact damage to avoid the crash completely.

Automatic emergency braking is only available up to certain speeds. See **Pre-Collision Assist Limitations** (page 376).

SWITCHING AUTOMATIC EMERGENCY BRAKING ON AND OFF

To switch the system on or off, use the touchscreen:

1. Press **Features** on the touchscreen.
2. Press **Driver Assistance**.
3. Press **Pre-Collision Assist**.
4. Press **Auto Emergency Braking**.
5. Switch the feature on or off.

EVASIVE STEERING ASSIST

WHAT IS EVASIVE STEERING ASSIST

If your vehicle is rapidly approaching a road user, evasive steering assist helps you steer around the road user.

After you turn the steering wheel in an attempt to avoid a crash with the road user, the system applies additional steering torque to help you steer around the road user. After you pass the road user, the system applies steering torque when you turn the steering wheel to steer back into the lane. The system deactivates after you fully pass the road user.

Note: *Road users are defined as another stationary vehicle in the same lane or a vehicle traveling in the same lane in the same direction as you. See **Pre-Collision Assist Precautions** (page 375).*

EVASIVE STEERING ASSIST LIMITATIONS

Evasive steering assist only activates when all the following occur:

- Automatic emergency braking and evasive steering assist are on.
- The system detects a road user ahead and starts to apply the brakes.
- You significantly turn the steering wheel to steer around a road user.

Note: *Evasive steering assist does not automatically steer around a road user. If you do not turn the steering wheel, evasive steering assist does not activate.*

Note: *Evasive steering assist does not activate if the distance to the road user ahead is too small and the system cannot avoid a crash.*

Note: *Evasive steering does not activate with cyclists or pedestrians.*

Pre-Collision Assist (If Equipped)

SWITCHING EVASIVE STEERING ASSIST ON AND OFF

To switch the system on or off, use the touchscreen:

1. Press **Features** on the touchscreen.
2. Press **Driver Assistance**.
3. Press **Pre-Collision Assist**.
4. Switch **Evasive Steering** on or off.

Note: *If you switch automatic emergency braking off, evasive steering assist turns off.*

Note: *Automatic emergency braking and evasive steering assist turn on every time you switch the ignition on.*

PRE-COLLISION ASSIST – TROUBLESHOOTING

PRE-COLLISION ASSIST – WARNING LAMPS



A telltale illuminates in the cluster to indicate if the system is disabled or unavailable.

PRE-COLLISION ASSIST – INFORMATION MESSAGES - POLICE RESPONDER

| Message | Details |
|------------------------------------|--|
| Pre-Collision Assist Not Available | A fault with the system has occurred. Have your vehicle checked as soon as possible. |

Pre-Collision Assist (If Equipped)

PRE-COLLISION ASSIST – INFORMATION MESSAGES

| Message | Action |
|---|--|
| Pre-Collision Assist Not Available Sensor Blocked | You have a blocked sensor due to bad weather, ice, mud or water in front of the radar sensor. You can typically clean the sensor to resolve. |
| Pre-Collision Assist Not Available | A fault with the system has occurred. Have your vehicle checked as soon as possible. |

Pre-Collision Assist (If Equipped)

PRE-COLLISION ASSIST – FREQUENTLY ASKED QUESTIONS - POLICE RESPONDER

Camera Troubleshooting

The windshield in front of the camera is dirty or obstructed.

Clean the outside of the windshield in front of the camera.

The windshield in front of the camera is clean, but the message remains in the instrument cluster display.

Wait a short time. It could take several minutes for the camera to detect that there is no obstruction.

PRE-COLLISION ASSIST – FREQUENTLY ASKED QUESTIONS

Camera Troubleshooting

The windshield in front of the camera is dirty or obstructed.

Clean the outside of the windshield in front of the camera.

The windshield in front of the camera is clean, but the message remains in the instrument cluster display.

Wait a short time. It could take several minutes for the camera to detect that there is no obstruction.

Radar Troubleshooting (If Equipped)

The surface of the radar in the grille is dirty or obstructed.

Clean the grille surface in front of the radar or remove the object causing the obstruction.

The surface of the radar in the grille is clean, but the message remains in the instrument cluster display.

Wait a short time. It could take several minutes for the radar to detect that there is no obstruction.

Heavy rain, spray or fog is interfering with the radar signals.

The pre-collision assist system is temporarily disabled. Pre-collision assist reactivates a short time after the weather conditions improve.

Swirling water or snow or ice on the surface of the road is interfering with the radar signals.

The pre-collision assist system is temporarily disabled. Pre-collision assist reactivates a short time after the weather conditions improve.

Radar is out of alignment due to a front-end impact.

Have your vehicle serviced to have the radar checked for proper coverage and operation.

PRE-COLLISION ASSIST – FREQUENTLY ASKED QUESTIONS - VEHICLES WITH: INTERSECTION ASSIST

Camera Troubleshooting

The windshield in front of the camera is dirty or obstructed.

Clean the outside of the windshield in front of the camera.

The windshield in front of the camera is clean, but the message remains in the instrument cluster display.

Wait a short time. It could take several minutes for the camera to detect that there is no obstruction.

Pre-Collision Assist (If Equipped)

Radar Troubleshooting (If Equipped)

The surface of the radar in the grille is dirty or obstructed.

Clean the grille surface in front of the radar or remove the object causing the obstruction.

The surface of the radar in the grille is clean, but the message remains in the instrument cluster display.

Wait a short time. It could take several minutes for the radar to detect that there is no obstruction.

Heavy rain, spray or fog is interfering with the radar signals.

The pre-collision assist system is temporarily disabled. Pre-collision assist reactivates a short time after the weather conditions improve.

Swirling water or snow or ice on the surface of the road could interfere with the radar signals.

The pre-collision assist system is temporarily disabled. Pre-collision assist reactivates a short time after the weather conditions improve.

Radar is out of alignment due to a front end impact.

Have your vehicle serviced to have the radar checked for proper coverage and operation.

Driver Alert (If Equipped)

WHAT IS DRIVER ALERT

Driver alert alerts you if it determines that you are becoming drowsy or if your driving deteriorates.

HOW DOES DRIVER ALERT WORK

Driver Alert calculates your alertness level based on your driving behavior in relation to the lane markings and other factors through use of the front camera sensor behind the interior mirror.

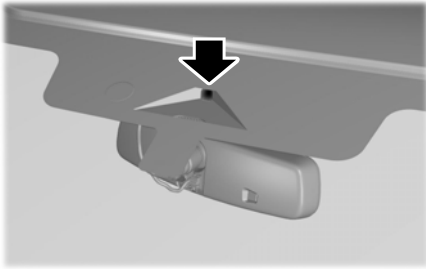

DRIVER ALERT PRECAUTIONS

WARNING: You are responsible for controlling your vehicle at all times. The system is designed to be an aid and does not relieve you of your responsibility to drive with due care and attention. Failure to follow this instruction could result in the loss of control of your vehicle, personal injury or death.

WARNING: Take regular rest breaks if you feel tired. Do not wait for the system to warn you.

WARNING: Certain driving styles may result in the system warning you even if you are not feeling tired.

WARNING: In cold and severe weather conditions the system may not function. Rain, snow and spray can all limit sensor performance.

WARNING: The system will not operate if the sensor cannot track the road lane markings.

WARNING: If damage occurs in the immediate area surrounding the sensor, have your vehicle checked as soon as possible.

WARNING: The system may not correctly operate if your vehicle is fitted with a suspension kit not approved by us.

WARNING: The system may not operate properly if the sensor is blocked. Keep the windshield free from obstruction.

Note: If something is blocking the camera or damaged the windshield, Driver Alert may not function.

DRIVER ALERT LIMITATIONS

Driver alert may not function correctly if:

- The sensor cannot track the road lane markings.
- Your vehicle's speed is less than approximately 40 mph (65 km/h).

SWITCHING DRIVER ALERT ON AND OFF

1. Press **Features** on the touchscreen.

Driver Alert (If Equipped)

2. Press **Driver Assistance**.
3. Switch **Driver Alert** on or off.

Note: *The system remains on or off depending on how it was last set.*

Resetting Driver Alert

You can reset the system by either:

- Switching the ignition off and on.
- Opening and closing the driver door when your vehicle is stationary, and it is safe to do so.

DRIVER ALERT – TROUBLESHOOTING

DRIVER ALERT – INFORMATION MESSAGES

| Message | Action |
|-------------------------------------|---|
| Driver Alert Warning Rest Now | Stop and rest as soon as it is safe to do so. |
| Driver Alert Warning Rest Suggested | Take a rest soon. |

Load Carrying

LOAD CARRYING PRECAUTIONS

Keep your loaded vehicle weight within its design rating capability, with or without a trailer. Properly loading your vehicle provides maximum return of vehicle design performance. Before you load your vehicle, become familiar with the following terms for determining your vehicle's weight rating, with or without a trailer, from the vehicle's Tire and Loading Information label or Safety Compliance Certification label.



WARNING: Vehicles with a higher center of gravity (utility and four-wheel drive vehicles) handle differently than vehicles with a lower center of gravity (passenger cars). Avoid sharp turns, excessive speed and abrupt steering in these vehicles. Failure to drive cautiously increases the risk of losing control of your vehicle, vehicle rollover, personal injury and death.



WARNING: The appropriate loading capacity of your vehicle can be limited either by volume capacity (how much space is available) or by payload capacity (how much weight the vehicle should carry). Once you have reached the maximum

payload of your vehicle, do not add more cargo, even if there is space available. Overloading or improperly loading your vehicle can contribute to loss of vehicle control and vehicle rollover.



WARNING: Exceeding the Safety Compliance Certification label vehicle weight limits can adversely affect the performance and handling of your vehicle, cause vehicle damage and can result in the loss of control of your vehicle, serious personal injury or death.



WARNING: Do not use replacement tires with lower load carrying capacities than the original tires because they may lower your vehicle's GVWR and GAWR limitations. Replacement tires with a higher limit than the original tires do not increase the GVWR and GAWR limitations.



WARNING: Do not exceed the GVWR or the GAWR specified on the certification label.



WARNING: Exceeding any vehicle weight rating can adversely affect the performance and handling of your vehicle, cause vehicle damage and can result in the loss of control of your vehicle, serious personal injury or death.

Load Carrying



WARNING: When loading the roof racks, we recommend you evenly distribute the load, as well as maintain a low center of gravity. Loaded vehicles, with higher centers of gravity, may handle differently than unloaded vehicles. Take extra precautions, such as slower speeds and increased stopping distance, when driving a heavily loaded vehicle.

The gross combined weight must never exceed the Gross Combined Weight Rating.

USING A SLIDE-IN CAMPER

For information regarding the use of slide-in campers, consult the Truck Camper Loading document supplied with your vehicle.

Note: We do not recommend using a slide-in camper on an F-150 SuperCrew cab.

Note: We do not recommend using a slide-in camper on a Raptor.

LOCATING THE SAFETY COMPLIANCE CERTIFICATION LABELS

Safety Compliance Certification Label Example:

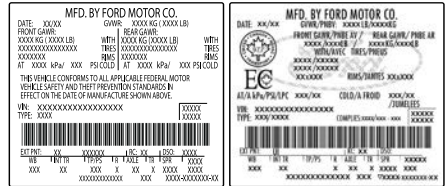

The Safety Compliance Certification label is located on the door hinge pillar, door-latch post, or the door edge that meets the door-latch post, next to the driver seating position.

WHAT IS THE GROSS AXLE WEIGHT RATING

GAWR (Gross Axle Weight Rating)

GAWR is the maximum allowable weight that a single axle (front or rear) can carry. These numbers are on the Safety Compliance Certification label.

WHAT IS THE GROSS VEHICLE WEIGHT RATING

GVWR is the maximum allowable weight of the fully loaded vehicle. This includes all options, equipment, passengers and cargo. It appears on the Safety Compliance Certification label.

Load Carrying

WHAT IS THE GROSS COMBINED WEIGHT RATING

Gross Combined Weight Rating (GCWR) is the maximum allowable weight of the vehicle and the loaded trailer, including all cargo and passengers, that the vehicle can handle without risking damage. (Important: The towing vehicle's braking system is rated for operation at Gross Vehicle Weight Rating, not at Gross

Combined Weight Rating.) Separate functional brakes should be used for safe control of towed vehicles and for trailers where the Gross Combined Weight of the towing vehicle plus the trailer exceed the Gross Vehicle Weight Rating of the towing vehicle.

Note: *For trailer towing information refer to the RV and Trailer Towing Guide available at an authorized dealer, or online at the website that follows.*

| | |
|---|--|
| RV & Trailer Towing Guide Online | |
| Website | www.fleet.ford.com/towing-guides |

Load Carrying

CALCULATING PAYLOAD

Tire and Loading Label Information

Example:



TIRE AND LOADING INFORMATION

SEATING CAPACITY TOTAL: 5 FRONT: 2 REAR: 3

The combined weight of occupants and cargo should never exceed **385 kg or 850 lbs.**

| TIRE | SIZE | COLD TIRE PRESSURE | SEE OWNERS MANUAL FOR ADDITIONAL INFORMATION |
|-------|---------------|--------------------|---|
| FRONT | 235/45R18 94V | 235 KPA, 34 PSI | |
| REAR | 235/45R18 94V | 235 KPA, 34 PSI | |
| SPARE | NONE | NONE | |



TIRE AND LOADING INFORMATION
RENSEIGNEMENTS SUR LES PNEUS ET LE CHARGEMENT

SEATING CAPACITY TOTAL: 5 FRONT: 2 REAR: 3
NOMBRE DE PLACES

The combined weight of occupants and cargo should never exceed **396 kg or 875 lbs.**
Le poids total des occupants et du chargement ne doit jamais dépasser

| TIRE PNEU | SIZE DIMENSIONS | COLD TIRE PRESSURE PRESSION DES PNEUS A FROID | SEE OWNER'S MANUAL FOR ADDITIONAL INFORMATION VOIR LE MANUEL DE L'USAGER POUR PLUS DE RENSEIGNEMENTS |
|------------------|-----------------|---|---|
| FRONT AVANT | 235/40R19 96V | 255 KPA, 37 PSI | |
| REAR ARRIERE | 235/40R19 96V | 255 KPA, 37 PSI | |
| SPARE DE SECOURS | T125/80R16 97M | 415 KPA, 60 PSI | |

Payload is the combined weight of cargo and passengers that your vehicle is carrying. The maximum payload for your vehicle appears on the Tire and Loading label. The label is either on the B-pillar or the edge of the driver door. Vehicles exported outside the US and Canada may not have a tire and loading label. Look for "The combined weight of occupants and cargo should never exceed XXX kg or XXX lb" for maximum payload. The payload listed on the Tire and Loading Information label

is the maximum payload for your vehicle as built by the assembly plant. If you install any additional equipment on your vehicle, you must determine the new payload. Subtract the weight of the equipment from the payload listed on the Tire and Loading label. When towing, trailer tongue weight or king pin weight is also part of payload.

CALCULATING THE LOAD LIMIT

Steps for determining the correct load limit:

1. Locate the statement "The combined weight of occupants and cargo should never exceed XXX kg or XXX lb." on your vehicle's placard.
2. Determine the combined weight of the driver and passengers that will be riding in your vehicle.
3. Subtract the combined weight of the driver and passengers from XXX kg or XXX lb.
4. The resulting figure equals the available amount of cargo and luggage load capacity. For example, if the "XXX" amount equals 1,400 lb. and there will be five 150 lb. passengers in your vehicle, the amount of available cargo and luggage load capacity is 650 lb. (1400-750 (5 x 150) = 650 lb.)

Load Carrying

- Determine the combined weight of luggage and cargo being loaded on the vehicle. That weight may not safely exceed the available cargo and luggage load capacity calculated in Step 4.
- If your vehicle will be towing a trailer, load from your trailer will be transferred to your vehicle. Consult this manual to determine how this reduces the available cargo and luggage load capacity of your vehicle.

Helpful examples for calculating the available amount of cargo and luggage load capacity

Suppose your vehicle has a 1400-pound (635-kilogram) cargo and luggage capacity. You decide to go golfing. Is there enough load capacity to carry you, four of your friends and all the golf bags? You and four friends average 220 pounds (99 kilograms) each and the golf bags weigh approximately 30 pounds (13.5 kilograms) each. The calculation would be: $1400 - (5 \times 220) - (5 \times 30) = 1400 - 1100 - 150 = 150$ pounds. Yes, you have enough load capacity in your vehicle to transport four friends and your golf bags. In metric units, the calculation would be: $635 \text{ kilograms} - (5 \times 99 \text{ kilograms}) - (5 \times 13.5 \text{ kilograms}) = 635 - 495 - 67.5 = 72.5$ kilograms.

Suppose your vehicle has a 1400-pound (635-kilogram) cargo and luggage capacity. You and one of your friends decide to pick up cement from the local home improvement store to finish that patio you have been planning for the past two years. Measuring the inside of the vehicle with the rear seat folded down, you have room for twelve 100-pound (45-kilogram) bags of cement. Do you have enough load capacity to transport the cement to your home? If you and your friend each weigh 220 pounds (99 kilograms), the calculation would be: $1400 - (2 \times 220) - (12 \times 100) = 1400 - 440 - 1200 = -240$ pounds. No, you do not have enough cargo capacity to carry that much weight. In metric units, the calculation would be: $635 \text{ kilograms} - (2 \times 99 \text{ kilograms}) - (12 \times 45 \text{ kilograms}) = 635 - 198 - 540 = -103$ kilograms. You will need to reduce the load weight by at least 240 pounds (104 kilograms). If you remove three 100-pound (45-kilogram) cement bags, then the load calculation would be: $1400 - (2 \times 220) - (9 \times 100) = 1400 - 440 - 900 = 60$ pounds. Now you have the load capacity to transport the cement and your friend home. In metric units, the calculation would be: $635 \text{ kilograms} - (2 \times 99 \text{ kilograms}) - (9 \times 45 \text{ kilograms}) = 635 - 198 - 405 = 32$ kilograms.

Load Carrying

The above calculations also assume that the loads are positioned in your vehicle in a manner that does not overload the front or the rear gross axle weight rating specified for your vehicle on the Safety Compliance Certification label.

Pickup Bed

PICKUP BED PRECAUTIONS



WARNING: Do not allow people or animals in truck beds that have modifications, such as bed covers or slide-in campers, when the engine is running. Exhaust fumes are toxic. Failure to follow this instruction could result in personal injury or death.



WARNING: It is extremely dangerous to ride in a cargo area, inside or outside of a vehicle. In a crash, people riding in these areas are more likely to be seriously injured or killed. Do not allow people to ride in any area of your vehicle that is not equipped with seats and seatbelts. Make sure everyone in your vehicle is in a seat and properly using a seatbelt. Failure to follow this warning could result in serious personal injury or death.

PICKUP BED ANCHOR POINTS

PICKUP BED ANCHOR POINT PRECAUTIONS



WARNING: Always properly secure cargo to prevent shifting cargo or cargo falling from the vehicle. Failure to do so could result in compromised vehicle stability and serious personal injury to vehicle occupants or others.



WARNING: The appropriate loading capacity of your vehicle can be limited either by volume capacity (how much space is available) or by payload capacity (how much weight the vehicle should carry). Once you have reached

the maximum payload of your vehicle, do not add more cargo, even if there is space available. Overloading or improperly loading your vehicle can contribute to loss of vehicle control and vehicle rollover.



WARNING: It is extremely dangerous to ride in a cargo area, inside or outside of a vehicle. In a crash, people riding in these areas are more likely to be seriously injured or killed. Do not allow people to ride in any area of your vehicle that is not equipped with seats and seatbelts. Make sure everyone in your vehicle is in a seat and properly using a seatbelt. Failure to follow this warning could result in serious personal injury or death.



WARNING: Do not use the load retaining fixtures for towing. Failure to follow this instruction could result in personal injury.



WARNING: Do not exceed the maximum load rating of the load retaining fixtures. Failure to follow this instruction could result in personal injury.



WARNING: Check the load retaining fixtures for damage before using them. Failure to follow this instruction could result in personal injury.

INSTALLING AND REMOVING THE PICKUP BED TIE-DOWN CLEATS

(If Equipped)

Installing the Cleats

1. Insert the key into the lock and turn clockwise to unlock.
2. Insert the cleat into the pickup bed anchor point and slide upward.
3. Turn the key counterclockwise to lock.

Pickup Bed

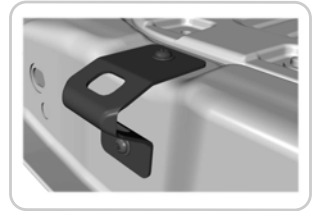
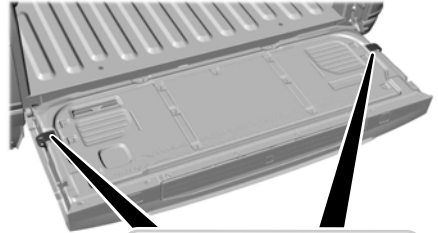
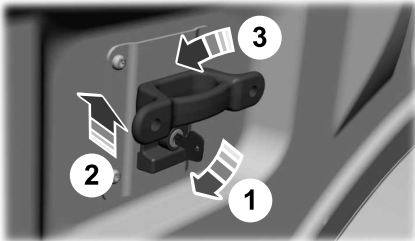
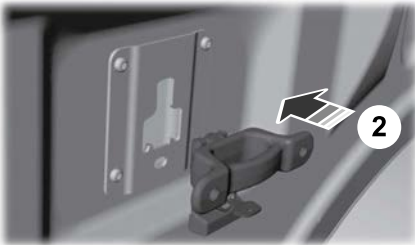

Note: You could damage the tailgate if you overload the tie downs.

Note: Leave the key in the lock when removing or installing the cleats. The key cannot be removed unless it is in the locked position.

Removing the Cleats

To remove, reverse the installation procedure.

TAILGATE ANCHOR POINTS

LOCATING THE TAILGATE ANCHOR POINTS

The tailgate anchor points are located at each side of the tailgate.

TAILGATE ANCHOR POINT LOAD CAPACITIES

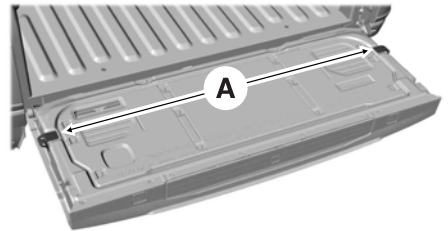

Pickup Bed

A

The maximum force between the tailgate anchor points 400 lb (181 kg).

Note: Do not secure cargo from a pickup bed anchor point to a tailgate anchor point. This could cause the tailgate to detach.

PICKUP BED RAMPS

PICKUP BED RAMP PRECAUTIONS

WARNING: When sliding the ramp up or down, take care not to get your fingers or hands caught in the mechanism. Failure to follow this instruction could result in personal injury.

WARNING: Make sure that you correctly install the ramp to the tailgate plate. Failure to follow this instruction could result in personal injury.

WARNING: Do not step or sit on the ramp when it is in the stowed position. Failure to follow this instruction could result in personal injury.

WARNING: Only install the ramp within the prescribed ramp angles. Failure to follow this instruction could result in personal injury.

Note: Each pickup bed ramp has a maximum capacity of 400 lb (181.4 kg).

Note: Verify the ramp is on stable ground before usage.

Note: For loading and unloading equipment, your ramp should be set between 10 degrees upward and 26 degrees downward to avoid damage to the ramp claw and tailgate plate.

Note: When using your vehicle for off-road operation, remove the bed ramps from the vehicle and store them in a safe location away from your vehicle.

INSTALLING AND REMOVING THE PICKUP BED RAMP HOLDER

Installing the Ramp Holder

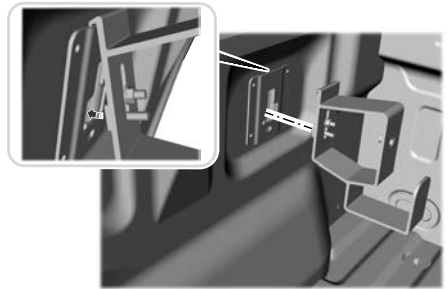

1. Hook the top of the ramp holder over the mounting plate and rotate the ramp holder into position.

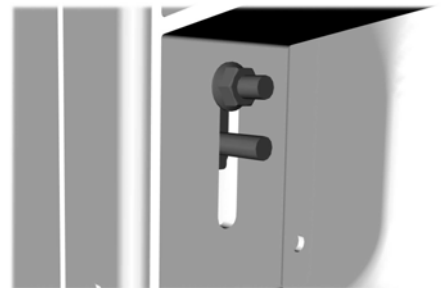

2. Slide the ramp holder studs upwards into the installed position.

Pickup Bed

3. Tighten the ramp holder nut.

Note: *The nut should be on the upper stud.*

Removing the Ramp Holder

Remove in the reverse order.

INSTALLING AND REMOVING THE PICKUP BED RAMPS

Note: *You cannot use the pickup bed ramps with the tailgate work surface or tailgate step.*

Installing the Bed Ramp

1. Remove the front and rear cables.

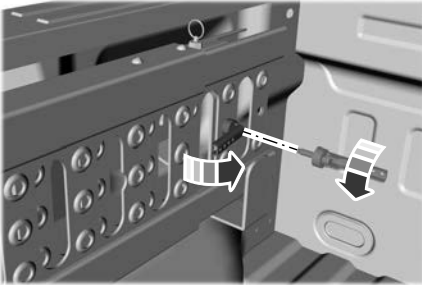

2. Open the cam lever arms and unscrew the cam bolts.
3. Remove the ramp from the ramp holder.



4. Rotate the stops at the underside of the ramp to the open position.

Note: *You can use a smooth surface tool to rotate the stops.*

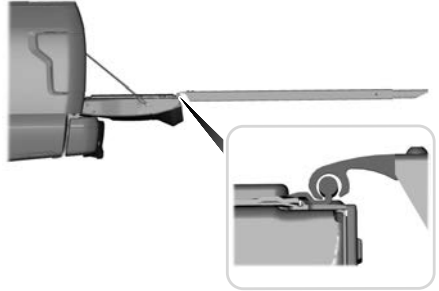

5. Slide the ramp claw onto the tailgate plate.

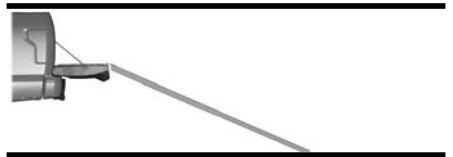
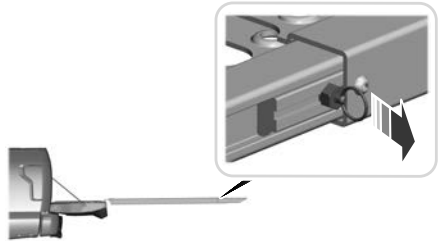

Pickup Bed

6. Pull the location pin outward and extend the ramp until the pin is seated in the usage position, then set the ramp on even ground.

Removing the Ramp

Remove in the reverse order.

STORING THE PICKUP BED RAMPS

Storing the Bed Ramp

1. Pick up the ramp. Pull the location pin outward.
2. Slide the ramp into the storage position until the location pin locks.

Note: *Make sure the proper pin location has been applied for your bed size.*

3. Slide the ramp claw off of the tailgate plate.
4. Rotate the stops at the underside of the ramp to the closed position.

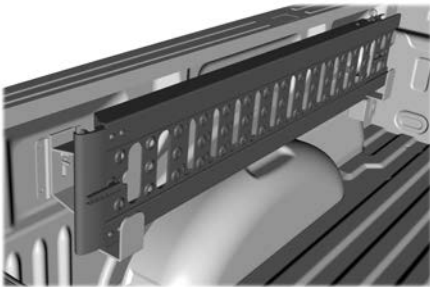

5. Place the ramp into the ramp holder.
6. Install the cam bolts and close the cam lever arms.
7. Attach the front and rear cables.

Note: *Make sure you properly secure the locking cable. If the locking cable is unsecured, you may hear a rattling noise.*

Connecting a Trailer

CONNECTING A TRAILER PRECAUTIONS

Do not tow a trailer until you drive your vehicle at least 1,000 mi (1,600 km).

Consult your local motor vehicle laws for towing a trailer.

See the instructions included with towing accessories for the proper installation and adjustment specifications.

Service your vehicle more frequently if you tow a trailer. See **Normal Scheduled Maintenance** (page 645).

If you use a rental trailer, follow the instructions the rental agency gives you.

When attaching the trailer wiring connector to your vehicle, only use a proper fitting connector that works with the vehicle and trailer functions.

Account for the trailer coupler weight as part of your vehicle load when calculating the total vehicle weight.

Do not exceed the load limits. See **Calculating the Load Limit** (page 391).

HITCHES

HOOKING UP A TRAILER USING A WEIGHT-DISTRIBUTING HITCH



WARNING: Do not adjust the spring bars so that your vehicle's rear bumper is higher than before attaching the trailer. Doing so will defeat the function of the weight-distributing hitch, which may cause unpredictable handling, and could result in serious personal injury.

A weight-distributing hitch helps distribute tongue load to all towing vehicle and trailer wheels. For more information, visit the links in the following table.

| Market | Website |
|--------------------------|---|
| United States of America | https://www.fleet.ford.com/towing-guides/ |
| Canada | https://www.fleet.ford.ca/towing-guides/ |

CONNECTING A TRAILER

Recognizing a Trailer

1. Attach the trailer and wiring connector to your vehicle.
2. Switch on your vehicle.
3. Set up a profile for the trailer using the touchscreen.

Note: *If your vehicle does not recognize the trailer, press and hold the brake pedal for a few seconds.*

Note: *Trailer profiles store trailer types, dimensions, preferences, trailer specific mileage and fuel economy.*

Note: *Disabling the trailer detection notification makes the default trailer profile active when the system detects a connection.*

Connecting a Trailer

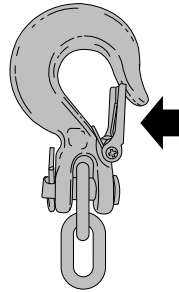
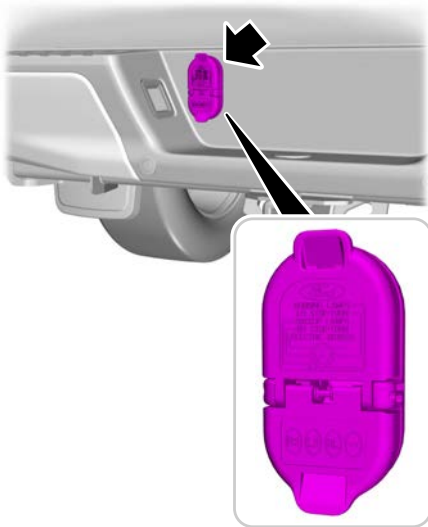

If the trailer safety chain hook has a latch, fully close the latch.

Trailer Connection Checklist

1. Press **Features** on the touchscreen.
2. Press **Towing**.
3. Press **Connection Checklist**.

Electronic Park Hold



Applies the electronic parking brake when you shift to park (P).

The electronic park hold button illuminates when activated.

The feature prevents your vehicle from moving in any direction when aligned with your trailer coupler and you shift to park (P).

Note: *The feature is active for the current key cycle.*

You can also press a zoom button when using the camera views to switch the feature on.

Trailer Connection Alarm

The alarm is set when the following occur:

- Your vehicle detects the trailer.
- You lock your vehicle.
- You arm the alarm.

When attaching the trailer wiring connector to your vehicle, only use a proper fitting connector that works with the vehicle and trailer functions.

Safety Chains

Install trailer safety chains to the trailer hitch as recommended by the manufacturer. Cross the chains under the trailer coupler and allow enough slack for turning tight corners. Do not allow the chains to drag on the ground.

Note: *Do not attach safety chains to the bumper. Always connect the safety chains to the frame or hook retainers of your trailer hitch.*

Connecting a Trailer

When the trailer disconnects in this state, the vehicle alarm sounds and the system sends an alert to your FordPass app.

Note: For reliable trailer detection, the trailer's lamps must be SAE certified for each intended purpose.

Note: If the trailer is not compatible with the feature, the turn signals flash twice.

Switching the Trailer Connection Alarm On and Off

1. Press **Features** on the touchscreen.
2. Press **Towing**.
3. Press **Manage trailers**.
4. Press the currently active trailer's name.
5. Switch **Trailer Connection Alarm** on or off.

Note: The alarm disables by default. If the system detects a trailer, it can be configurable.

Note: Settings are applicable only for the selected trailer profile.

Trailer Connector Battery Lead

The trailer receives power from the vehicle trailer connector battery lead when the following occurs:

- Your vehicle is in accessory mode or switched on.
- The trailer wiring connector is free of corrosion or other damage.

- The vehicle battery is not low.
- When the trailer has a battery:
 - The trailer battery voltage is within 5 volts of the vehicle battery voltage.
 - When you have the trailer battery properly connected.

TRAILER LIGHTING CHECK



WARNING: Never connect any trailer lamp wiring to the vehicle's tail lamp wiring; this may damage the electrical system resulting in fire. Contact your authorized dealer as soon as possible for assistance in proper trailer tow wiring installation. Additional electrical equipment may be required.

Perform a trailer light illumination sequence to confirm that all lights are functioning by using the FordPass app or the vehicle's touchscreen.

Performing the Trailer Lighting Check Using the Touchscreen

1. Press **Features** on the touchscreen.
2. Press **Towing**.
3. Press **Trailer Light Check**.
4. Press **Start**.

Connecting a Trailer

CONNECTING A TRAILER – TROUBLESHOOTING

CONNECTING A TRAILER – INFORMATION MESSAGES

| Message | Description |
|---|---|
| Trailer Disconnected | The system senses a trailer connection becomes disconnected, either intentionally or unintentionally, during a given ignition cycle. |
| Trailer Wiring Fault | There are certain faults in your vehicle wiring and trailer wiring or brake system. |
| Trailer Battery Not Charging See Manual | There is a fault with your trailer battery, or your trailer battery voltage is very low. |
| Trailer Tire Low Specified: | One or more tires on your trailer is below the specified tire pressure. |
| Trailer Tire Over Temperature | Displays when one or more tires on the trailer is above the recommended temperature. |
| Trailer Tire Pressure Sensor Fault | A trailer tire pressure sensor is malfunctioning. If the warning stays on or continues to come on, have the system checked as soon as possible. |
| Trailer Tire Pressure Monitor Fault | The trailer tire pressure monitoring system is malfunctioning. If the warning stays on or continues to come on, have the system checked. |
| Trailer Tire Pressure Monitor Capability Not Detected | The system cannot detect the trailer tire pressure monitoring system. |
| Trailer Tire Pressure Indication Not Setup See Manual | The trailer tire pressure monitoring system is not setup. |

Towing a Trailer

TOWING A TRAILER PRECAUTIONS

 **WARNING:** Do not exceed the GVWR or the GAWR specified on the certification label.

 **WARNING:** Towing trailers beyond the maximum recommended gross trailer weight exceeds the limit of your vehicle and could result in engine damage, transmission damage, structural damage, loss of vehicle control, vehicle rollover and personal injury.

 **WARNING:** Do not exceed the lowest rating capacity for your vehicle or trailer hitch. Overloading your vehicle or trailer hitch can impair your vehicle stability and handling. Failure to follow this instruction could result in the loss of control of your vehicle, personal injury or death.

 **WARNING:** Make sure that the vertical load on the tow ball is between the minimum and maximum recommended weight at all times. Failure to follow this instruction could result in the loss of control of your vehicle, personal injury or death.

 **WARNING:** Do not cut, drill, weld or modify the trailer hitch. Modifying the trailer hitch could reduce the hitch rating.

 **WARNING:** The anti-lock brake system does not control the trailer brakes.

TRAILER BRAKE PRECAUTIONS

 **WARNING:** Do not connect a trailer's hydraulic brake system directly to your vehicle's brake system. Your vehicle may not have enough braking power and your chances of having a collision greatly increase.

 **WARNING:** Do not tow a trailer fitted with electric trailer brakes unless your vehicle is fitted with a compatible aftermarket electronic trailer brake controller. Failure to follow this instruction could result in the loss of control of your vehicle, personal injury or death. For additional information and assistance, we recommend that you contact an authorized dealer.

Electric brakes and manual, automatic or surge-type trailer brakes are safe if you install them properly and adjust them to the manufacturer's specifications. The trailer brakes must meet local and federal regulations.

The rating for the tow vehicle's braking system operation is at the gross vehicle weight rating, not the gross combined weight rating.

Towing a Trailer

Certain states require functioning trailer brakes for trailers over a specified weight. Be sure to check state regulations for this specified weight.

Ford Motor Company recommends separate functioning brake systems for trailers weighing more than 1,500 lb (680 kg) when loaded.

TOWING A TRAILER LIMITATIONS

The vehicle's load capacity designation is by weight, not by volume, so you cannot necessarily use all available space when loading a vehicle or trailer.

Note: *Your vehicle could have reduced performance when operating at high altitudes and when heavily loaded or towing a trailer. When driving at elevation, to match driving performance as perceived at sea level, reduce gross vehicle weight and gross combination weight by 2% per 1,000 ft (300 m) of elevation.*

Note: *Do not use four-wheel drive when towing a trailer or when you heavily load your vehicle for extended periods of time.*

LOADING YOUR TRAILER

To help minimize how trailer movement affects your vehicle when driving:

- Load the heaviest items closest to the trailer floor.
- Load the heaviest items centered between the left and right side trailer tires.
- Load the heaviest items above the trailer axles or just slightly forward toward the trailer tongue. Do not allow the final trailer tongue weight to go above or below 10-15% of the loaded trailer weight. The trailer tongue weight should never exceed 10% of the maximum towing capacity.
- Select a ball mount with the correct rise or drop. When both the loaded vehicle and trailer are connected, the trailer frame should be level, or slightly angled down toward your vehicle, when viewed from the side.

TRAILER TOWING HINTS

Towing a trailer places an extra load on your vehicle's engine, transmission, axle, brakes, tires and suspension. Periodically inspect these components during and after any towing operation.

When driving with a trailer or payload, a slight takeoff vibration or shudder may be present due to the increased payload weight.

Towing a Trailer

Your vehicle may have a temporary or conventional spare tire. A temporary spare tire is different in diameter or width, tread-type, or is from a different manufacturer than the road tires on your vehicle. Consult information on the tire label or Safety Compliance label for limitations when using.

When towing a trailer:

- Obey country specific regulations for towing a trailer.
- Do not drive faster than 70 mph (113 km/h) during the first 500 mi (800 km).
- Do not make full-throttle starts.
- Check your hitch, electrical connections and trailer wheel lug nuts thoroughly after you have traveled 50 mi (80 km).
- When stopped in congested or heavy traffic during hot weather, place the transmission in park (P) to aid engine and transmission cooling and to help A/C performance.
- Turn off the speed control with heavy loads or in hilly terrain. The speed control may turn off when you are towing on long, steep slopes.
- Shift to a lower gear when driving down a long or steep hill. Do not continuously apply the brakes, as they may overheat and become less effective.
- If your transmission has Grade Assist or Tow/Haul, use this feature when towing. This provides engine braking and helps eliminate excessive transmission shifting for optimum fuel economy and transmission cooling.

- Your vehicle has AdvanceTrac with roll stability control. When towing a trailer, additional loads could cause the AdvanceTrac system to engage during cornering maneuvers. Reduce cornering speeds to make sure that you can maintain control of the vehicle and trailer if the AdvanceTrac system engages.
- Allow more distance for stopping with a trailer attached. Anticipate stops and gradually brake.
- Avoid parking on a slope. However, if you must park on a slope, turn the steering wheel to point your vehicle tires away from traffic flow, set the parking brake, place the transmission in park (P) and place wheel chocks in front and back of the trailer wheels.

Note: *Chocks are not included with your vehicle.*

LAUNCHING OR RETRIEVING A BOAT OR PERSONAL WATERCRAFT

When backing down a ramp during boat launching or retrieval:

- Do not allow the static water level to rise above the bottom edge of the rear bumper.
- Do not allow waves to break higher than 6 in (15 cm) above the bottom edge of the rear bumper.

Exceeding 6 in (15 cm) could allow water to enter vehicle components, causing internal damage to the components and affecting driveability, emissions and reliability.

Note: *Replace the rear axle lubricant anytime the rear axle has been submerged in water.*

Towing a Trailer

Note: Disconnect the trailer wiring connector before backing the trailer into the water.

Note: Reconnect the trailer wiring connector after removing the trailer from the water.

TOWING WEIGHTS AND DIMENSIONS

RECOMMENDED TOWING WEIGHTS

| Market | Website |
|--------------------------|---|
| United States of America | https://www.fleet.ford.com/towing-guides/ |
| Canada | https://www.fleet.ford.ca/towing-guides/ |

Towing a Trailer

WHAT IS THE MAXIMUM LOADED TRAILER WEIGHT

The maximum loaded trailer weight is the highest possible weight of a fully loaded trailer the vehicle can tow.

CALCULATING THE MAXIMUM LOADED TRAILER WEIGHT FOR YOUR VEHICLE

1. Start with the gross combined weight rating for your vehicle model and axle ratio.
2. Subtract all of the following that apply to your vehicle:
 - Vehicle curb weight.
 - Hitch hardware weight, for example a draw bar, ball, locks or weight distributing hardware.

- Driver weight.
- Passenger weight.
- Payload, cargo and luggage weight.
- Aftermarket equipment weight.

This equals the maximum loaded trailer weight for this combination.

Note: *The trailer tongue load is considered part of the payload for your vehicle. Reduce the total payload by the final trailer tongue weight.*

Note: *Consult an authorized dealer to determine the maximum trailer weight allowed for your vehicle if you are not sure.*

Towing a Trailer

TOWING A TRAILER – TROUBLESHOOTING

TOWING A TRAILER – INFORMATION MESSAGES

| Message | Details |
|--|---|
| Trailer Left Turn Lamps Fault Check Lamps | The left-hand trailer turn lamp requires service. |
| Trailer Right Turn Lamps Fault Check Lamps | The right-hand trailer turn lamp requires service. |
| Trailer Battery Not Charging See Manual | The trailer battery voltage is too low to charge. |
| Trailer Lighting Module Fault See Manual | The system detects a short created by the trailer lamps. Inspect and repair the trailer wiring, or have the system checked as soon as possible. |
| Trailer Stop Lamps Fault Check Lamps | The trailer stoplamps require service. |
| Trailer brake system fault See manual | Verify the trailer brake connections are secure and that the aftermarket trailer brake controller device is correctly installed. Perform a trailer brake and trailer light check if possible. If the message persists, have your vehicle checked as soon as possible. |
| Trailer brake module fault | Perform a trailer brake and trailer light check if possible. If the message persists, have your vehicle checked as soon as possible. |
| Trailer Sway Reduce Speed | The trailer sway control detects trailer sway. Reduce the vehicle's speed. |
| Trailer Tire Over Temperature | Displays when one or more tires on the trailer is above the recommended temperature. |
| Trailer Tire Low Specified: | One or more tires on your trailer is below the specified tire pressure. |
| Trailer Tire Pressure Sensor Fault | A trailer tire pressure sensor requires service. If the warning stays on or continues to come on, have the system checked as soon as possible. |

Towing a Trailer

| Message | Details |
|--|---|
| Trailer Tire Pressure Monitor Fault | The trailer tire pressure monitoring system requires service. If the warning stays on or continues to come on, have the system checked as soon as possible. |
| Trailer Tire Pressure Monitor Capability Not Detected | The system cannot detect the trailer tire pressure monitoring system. |
| Trailer Tire Pressure Indication Not Setup See Manual | The trailer tire pressure monitoring system is not setup. |

Integrated Trailer Brake Controller (If Equipped)

WHAT IS THE INTEGRATED TRAILER BRAKE CONTROLLER

The trailer brake controller assists in smooth and effective trailer braking based on the towing vehicle's brake pressure.

INTEGRATED TRAILER BRAKE CONTROLLER PRECAUTIONS



WARNING: Use the integrated trailer brake controller to properly adjust the trailer brakes and check all connections before towing a trailer. Failure to follow this instruction could result in the loss of control of your vehicle, personal injury or death.

- Only use the manual control lever for proper adjustment of the gain during trailer setup. Misuse, such as application during trailer sway, could cause instability of trailer or tow vehicle.
- Avoid towing in adverse weather conditions. The trailer brake controller does not provide anti-lock control of the trailer wheels. Trailer wheels can lock up on slippery surfaces, resulting in reduced stability of trailer and tow vehicle.
- The trailer brake controller is only a factory-installed or dealer-installed item. Ford is not responsible for warranty or performance of the controller due to misuse or customer installation.

Note: Do not attempt removal of the trailer brake controller without consulting the Workshop Manual. Damage to the unit may result.

USING THE INTEGRATED TRAILER BRAKE CONTROLLER

1. Make sure the trailer brakes are in good working condition, functioning normally and properly adjusted. See your trailer dealer if necessary.

Note: An authorized dealer can diagnose the trailer brake controller to determine exactly which trailer fault has occurred. Your vehicle warranty does not cover issues with your trailer.

2. Hook up the trailer and make the electrical connections according to the trailer manufacturer's instructions.

Note: Select default mode if the trailer has surge brakes, or no brakes at all. The system has no effect on the braking performance of the trailer in either of these cases.

Note: If a trailer is connected by a four-pin connector, the trailer braking function will not be supported.

3. When you plug in a trailer with electric or electric-over-hydraulic brakes, a message confirming connection appears in the information display.
4. Use the gain adjustment to find the desired starting point. A gain setting of 6.0 is a good starting point for heavier loads.

Note: Use the following steps to adjust the gain setting whenever road, weather and trailer, or vehicle loading conditions, change from when you initially set the gain.

5. In a traffic-free environment, tow the trailer on a dry, level surface and squeeze the manual control lever completely.

Integrated Trailer Brake Controller (If Equipped)

- If the trailer wheels lock up, indicated by squealing tires, reduce the gain setting. If the trailer wheels turn freely, increase the gain setting. Repeat Steps 5 and 6 until the gain setting is at a point just below trailer wheel lock-up. If towing a heavier trailer, trailer wheel lock-up may not be attainable even with the maximum gain setting of 10.

Note: Only perform this procedure at speeds of approximately 20–25 mph (30–40 km/h).

Note: The trailer brake controller reduces output at vehicle speeds below 11 mph (18 km/h) so that trailer and vehicle braking is not jerky or harsh. This feature is only available when applying the brakes using your vehicle's brake pedal, not the controller.

Note: Your vehicle's brake system and the trailer brake system work independently of each other. Changing the gain setting on the controller does not affect the operation of your vehicle's brakes whether you attach a trailer or not.

Note: With the proper electrical connection, pressing your vehicle brake pedal or using the manual control lever illuminates both trailer and vehicle brake lamps.

Note: When you switch the engine off, the controller output is disabled and the display and module shut down. The controller module and display turn on when you switch the ignition on.

Adjusting the Trailer Brake Gain

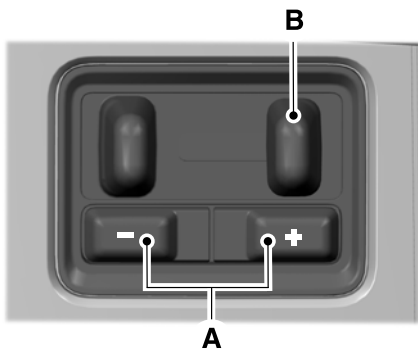

- A Increase or decrease the amount of gain in set increments.
- B Slide the control to engage the trailer brakes.

Note: Adjust gain setting before using the trailer brake controller for the first time.

Note: The gain should be set to provide the maximum trailer braking assistance while making sure the trailer wheels do not lock when using the brakes. Locked trailer wheels may lead to trailer instability.

Note: Setting adjustments are saved when a trailer profile is selected.

ADJUSTING THE INTEGRATED TRAILER BRAKE CONTROLLER MODE

Select the correct integrated trailer brake controller mode option using the touchscreen.

Note: Trailer brake gain settings are saved to the active trailer profile.

Integrated Trailer Brake Controller (If Equipped)

Selecting the Trailer Brake Type

1. Press **Default** for trailers with electromagnetic drum brake systems or press **Electric over Hydraulic** for trailers with electrically actuated hydraulic brake systems.
2. Press **Save**.

Selecting the Trailer Brake Effort

1. Select a setting for your trailer.
Note: *The default value is **Low** and is the recommended setting for most trailers. Select a different setting if your trailer's brakes require more initial voltage, or you prefer more aggressive trailer braking.*
2. Press **Save**.

INTEGRATED TRAILER BRAKE CONTROLLER – TROUBLESHOOTING

INTEGRATED TRAILER BRAKE CONTROLLER – INFORMATION MESSAGES

| Message | Details |
|---|---|
| Trailer Disconnected | The system detects the trailer wiring connection is disconnected, during a given ignition cycle. |
| Trailer Wiring Fault | The system detects an electrical fault in the trailer brake circuit. If this message appears without a trailer attached, see your authorized dealer. If a trailer is attached, inspect and repair the trailer wiring. |
| Trailer Brake Gain: {trailer gain value:#0.0} | Displays the current gain setting for the trailer brake. |
| Trailer Brake Gain: {trailer gain value:#0.0} No Trailer | Displays the current gain setting for the trailer brake when you do not have a trailer connected. |

Integrated Trailer Brake Controller (If Equipped)

INTEGRATED TRAILER BRAKE CONTROLLER – FREQUENTLY ASKED QUESTIONS

How do I determine if there is an issue with the wiring on my vehicle?

A message displays accompanied by a single tone, when no trailer is connected. This indicates that the issue is between the trailer brake controller and the 7-pin connector at the bumper.

How do I determine if there is an issue with the wiring on my trailer?

A message only displays with a trailer connected. Consult your trailer dealer for assistance.

Trailer Sway Control

HOW DOES TRAILER SWAY CONTROL WORK

The system applies the brakes to the individual wheels and reduces engine torque to aid vehicle stability.

If the trailer begins to sway, the stability control lamp flashes and the message **Trailer Sway Reduce Speed** appears in the information display.

Stop your vehicle as soon as it is safe to do so. Check the vertical weight on the tow ball and trailer load distribution.

2. Press **Towing**.
3. Switch **Trailer Sway Control** on or off.

The system turns on each time you start your vehicle.

TRAILER SWAY CONTROL PRECAUTIONS



WARNING: Turning off trailer sway control increases the risk of loss of vehicle control, serious injury or death. Ford does not recommend disabling this feature except in situations where speed reduction may be detrimental (such as hill climbing), the driver has significant trailer towing experience, and can control trailer sway and maintain safe operation.

Note: This feature only activates when significant trailer sway occurs.

Note: This feature does not prevent trailer sway, but reduces it once it begins.

Note: This feature cannot stop all trailers from swaying.

Note: In some cases, if vehicle speed is too high, the system may activate multiple times, gradually reducing vehicle speed.

SWITCHING TRAILER SWAY CONTROL ON AND OFF

1. Press **Features** on the touchscreen.

Trailer Hitching Assistance (If Equipped)

WHAT IS TRAILER HITCHING ASSISTANCE

Trailer hitching assistance helps the driver align the vehicle hitch ball to a trailer coupler.

HOW DOES TRAILER HITCHING ASSISTANCE WORK

Trailer hitching assistance uses the following to detect your trailer:

- Rear view camera.
- Radar.
- Parking aid sensors.
- External rear lighting.

This feature also controls the following to align the hitch ball with the trailer coupler:

- Steering.
- Shifting.
- Braking and acceleration.

Note: Blocked sensors could affect system performance. Do not cover the sensors with bumper stickers, tape, repair compound or other objects.

TRAILER HITCHING ASSISTANCE PRECAUTIONS



WARNING: You are responsible for controlling your vehicle at all times. The system is designed to be an aid and does not relieve you of your responsibility to drive with due care and attention. Failure to follow this instruction could result in the loss of control of your vehicle, personal injury or death.



WARNING: The system is not designed to detect cyclists, motorcyclists, pedestrians or animals. Apply the brakes when necessary. Failure to follow this instruction could result in personal injury or death.



WARNING: The system may not operate properly during severe weather conditions, for example snow, ice, heavy rain and spray. Always drive with due care and attention. Failure to take care may result in a crash.

Note: Trailer hitching assistance only works with conventional trailers, couplers and hitch balls.

Note: The hitch ball must be properly installed on the vehicle for the system to function as intended. An improperly installed hitch ball could result in damage to your vehicle or trailer.

Note: Certain aftermarket modifications such as oversized tires or lift kits could make trailer hitching assistance fail or not work as intended.

Note: Keep the sensors and camera free from snow, ice and dirt.

Note: Clean the camera lens with a soft, lint-free cloth and non-abrasive cleaner.

TRAILER HITCHING ASSISTANCE LIMITATIONS

The system could not function or could function with reduced performance during the following:

- When using trailer hitching assistance in tall grass and weeds.
- When safety chains, cables or wiring are dangling near the coupler.
- When using trailer hitching assistance on slippery surfaces.

Trailer Hitching Assistance (If Equipped)

- When using hitches that raise the hitch ball more than 4 in (10 cm), lower the hitch ball by more than 6 in (16 cm) or extend the hitch ball away from the vehicle more than 12 in (30 cm).
- When using objects taller than 8 in (20 cm), such as large blocks, under the jack stand.
- When you park the trailer on surfaces that are similar in color to the trailer coupler and hitch ball.
 - A black coupler or hitch ball over a dark asphalt surface.
 - A light color coupler or hitch ball over a light concrete surface.
- When there are low or no light sources, such as at night.

Press the button to switch the system on and off. You can also switch the system on and off through the touchscreen.

USING TRAILER HITCHING ASSISTANCE

Before switching on the system, make sure that your vehicle is:

- In front of the trailer facing the same direction.
- Within 20 ft (6 m) of the trailer and no closer than 7 ft (2 m).
- Less than a 15° approach angle to the trailer.
- Within 3 ft (1 m) of straight in-line with the trailer.
- Clear of obstacles or other vehicles within 6 ft (1.8 m) to the side of your vehicle or the trailer.

SWITCHING TRAILER HITCHING ASSISTANCE ON AND OFF

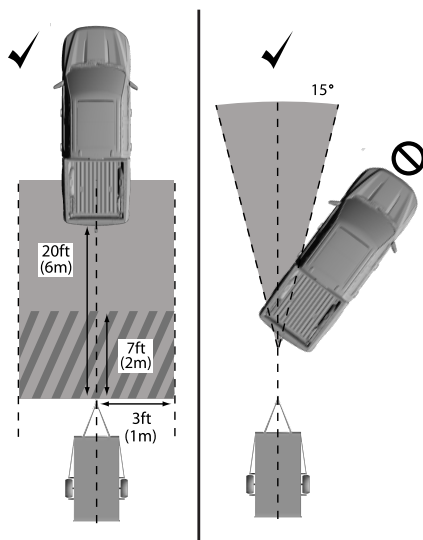
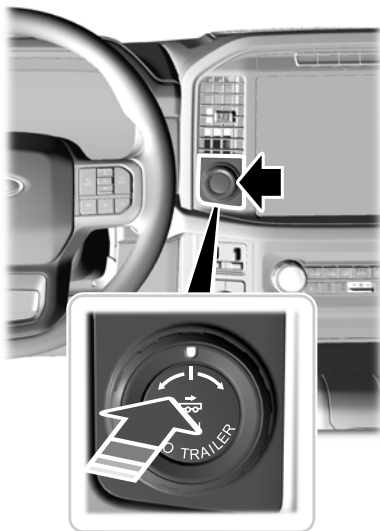

1. Press the button.

Trailer Hitching Assistance (If Equipped)

Note: Press the button to switch the system on and off.

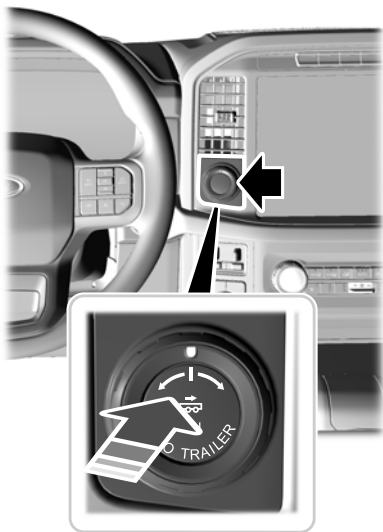

2. Follow the instructions on the touchscreen.

TRAILER HITCHING ASSISTANCE INDICATORS



The white indicator represents the system searching for the trailer. Continue moving the vehicle until the trailer coupler is inside this indicator. The indicator turns to green once the trailer coupler is in the correct position.



The bracket shows you the estimated location of your trailer coupler.



The yellow indicator represents that you have positioned your vehicle too close to the trailer and you need to pull away from the trailer until the indicator turns green.

Smart Hitch (If Equipped)

WHAT IS SMART HITCH

Smart hitch shows how balanced the weight is from the trailer onto the vehicle's hitch and front axle.

HOW DOES SMART HITCH WORK

Smart hitch uses sensors mounted to the suspension to calculate the tongue weight of the connected trailer.

SMART HITCH LIMITATIONS

You cannot use the system if any of the following occur:

- The wheels are not pointed straight ahead.
- Your vehicle is not in park (P).
- Your vehicle is not on a level surface.
- The tire pressures are below the recommended levels.
- Your vehicle is off.

USING SMART HITCH

1. Press **Features** on the touchscreen.
2. Press **Smart Hitch**.

Note: You can also access smart hitch using the FordPass app.

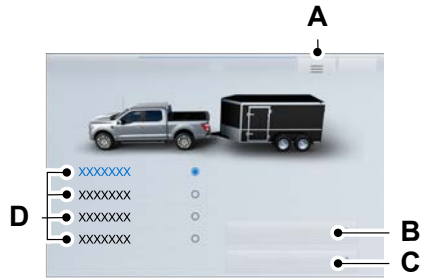

- A Settings menu.
- B Quick setup.
- C Connection checklist.
- D Hitch type selection.

Hitch Type Selection

Press to select the hitch type.

Quick Setup

Press to skip the trailer setup guide and adjust the load in the trailer to a balanced range.

Reset Hitch Weight

Press to reset the weight on the hitch to zero.

Loaded Trailer Weight

Press to set the total weight of the loaded trailer.

Note: The vehicle's tongue weight is not available until you attach a trailer.

Note: Make sure you include both the trailer weight and the trailer cargo in your calculation for total weight of the loaded trailer.

Smart Hitch (If Equipped)

Taillights

Press to see the hitch load balance on the vehicle's tail lamp.

Connection Checklist

Press to go through the trailer setup guide and adjust the load in the trailer to a balanced range.

Reset Hitch Weight

Press to reset the weight on the hitch to zero.

Loaded Trailer Weight

Press to set the total weight of the loaded trailer.

Note: *The vehicle's tongue weight is not available until you attach a trailer.*

Note: *Make sure you include both the trailer weight and the trailer cargo in your calculation for total weight of the loaded trailer.*

Taillights

Press to see the hitch load balance on the vehicle's tail lamp.

Smart Hitch Settings

Measurement Units

Press to change measurement units between pounds and kilograms.

On-Board Scale (If Equipped)

WHAT IS ON-BOARD SCALE

On-board scale provides the estimated payload of your vehicle and warns when your vehicle is overloaded.

HOW DOES ON-BOARD SCALE WORK

On-board scale uses sensors mounted to the suspension to calculate the vehicle's payload.

ON-BOARD SCALE LIMITATIONS

You cannot use the system if any of the following occur:

- The wheels are not pointed straight ahead.
- Your vehicle is not in park (P).
- Your vehicle is not on a level surface.
- The tire pressures are below the recommended levels.
- Your vehicle is off.

USING ON-BOARD SCALE

1. Press **Features** on the touchscreen.
2. Press **Onboard Scales**.

Note: You can also access on-board scale using the FordPass app.

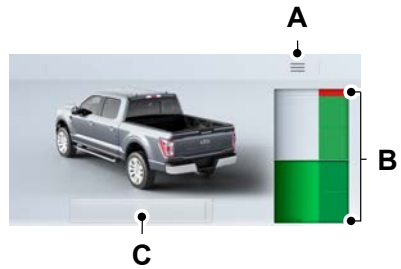

- A Settings menu.
- B Estimated payload.
- C Taillights on and off.

Taillights

Press to see the vehicle's estimated payload on the vehicle's tail lamp.

On-Board Scale Settings

Vehicle Mode

Press to return to the on-board scale screen.

Scale Mode

Press to see a representation of the weight added to the vehicle's current payload and to reset the scale to zero.

Note: The scale settings remain between key cycles.

Passenger and Cargo Load Reminder

Press to switch the load reminder on or off.

Set Passenger and Cargo Load Reminder

Press to set the estimated payload that is not in the vehicle when you use on-board scale.

The default and minimum value is 200 lb (100 kg).

On-Board Scale (If Equipped)

The maximum value is 1,400 lb (650 kg).

Press **Set Current Load as Estimate** to store the current payload of the vehicle.

Measurement Units

Press to change measurement units between pounds and kilograms.

Trailer Backup Assistance (If Equipped)

WHAT IS TRAILER BACKUP ASSISTANCE

Trailer backup assistance utilizes the control knob on the instrument panel to help you steer a trailer. Turn the control knob in the direction you want the trailer to go and the system steers the vehicle.

HOW DOES TRAILER BACKUP ASSISTANCE WORK

Trailer backup assistance uses a sticker or sensor attached to the trailer to detect the trailer angle relative to the towing vehicle and provides instructions, graphics and camera views on the touchscreen.

TRAILER BACKUP ASSISTANCE PRECAUTIONS



WARNING: Driving while distracted can result in loss of vehicle control, crash and injury. We strongly recommend that you use extreme caution when using any device that may take your focus off the road. Your primary responsibility is the safe operation of your vehicle. We recommend against the use of any hand-held device while driving and encourage the use of voice-operated systems when possible. Make sure you are aware of all applicable local laws that may affect the use of electronic devices while driving.



WARNING: This system is an extra driving aid. It does not replace your attention and judgment, or the need to apply the brakes. This system does NOT automatically brake your vehicle. If you fail to press the brake pedal when necessary, you may collide with another vehicle.

Note: *The system is not a substitute for safe driving practices. Always be aware of your vehicle and trailer combination, and the surrounding environment.*

Note: *The system does not detect or prevent your vehicle or trailer from making contact with obstacles in the surrounding environment.*

Note: *The front end of your vehicle swings out when changing the direction of the trailer.*

Note: *In certain conditions, the trailer could turn faster or the trailer angle could increase more than anticipated. Always monitor the clearance between the trailer and vehicle and the surroundings.*

SETTING UP THE TRAILER BACKUP ASSISTANCE FOR A CONVENTIONAL TRAILER

CONFIGURING THE TRAILER

You must configure a trailer in the system to use trailer backup assistance. This is a one-time setup process and the system saves the trailer information for the next time you use that trailer.

The system only works with conventional trailers. It does not work with other types including fifth-wheel and gooseneck. The following illustration shows examples of conventional trailers on the left-hand side.

Trailer Backup Assistance (If Equipped)

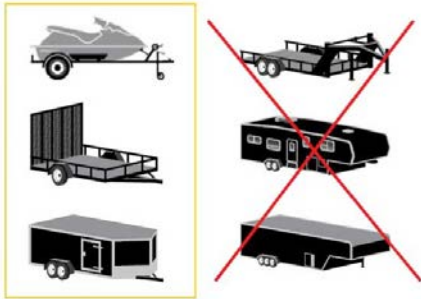

Positioning the Trailer

Hitch the trailer to your vehicle and connect the electrical wiring harness. Check to make sure that the wiring is working. See **Connecting a Trailer** (page 399).



Park your vehicle and hitched trailer on a level surface.

For best results, make sure that your trailer rides level with the ground when you hitch your vehicle. See **Connecting a Trailer** (page 399).



Make sure that the trailer and your vehicle are in line with each other. You can do this by putting the transmission in drive (D) and pulling straight forward.

Configuring the Trailer in the Touchscreen



1. Press the button to switch the system on.
2. Press **Add Trailer** on the touchscreen.
3. Follow the directions on the touchscreen to enter the trailer name and trailer type, then proceed to the sticker or sensor setup.

Trailer Backup Assistance (If Equipped)

Note: Your vehicle has two options for trailer backup assistance setup. The system defaults to the camera based system. See **Applying the Trailer Reversing Aid Sticker** (page 424). You can also setup the system with the trailer sensor that you can purchase from your authorized dealer. You must connect the sensor to your vehicle to setup the system. See **Trailer Sensor Installation** (page 424).

Note: If you configure the trailer and install a sensor, the system saves the trailer with that sensor information. If you want to use this trailer with the sticker, you need to delete the trailer from the system and repeat the setup process.

APPLYING THE TRAILER REVERSING AID STICKER

Place the sticker in an area visible by the rear view camera. The entire sticker must be within 4–19 in (10–48 cm) from the center of the hitch ball, as shown in the following illustration.

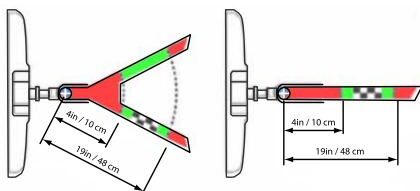

Use the supplied sticker placement card, a tape measure and pen to carefully mark the area to attach the sticker. The sticker is in the back cover pocket of your quick start guide. Make sure the entire sticker is within the green zone between the two arcs or distance markers on the diagram, and is also visible in the rear view camera display.

Once you have found the correct location, place the sticker.

Note: Make sure nothing can obstruct the rear view camera's view of the sticker such as a jack handle or wiring.

Note: Position the sticker on a flat, dry and clean horizontal surface. For best results, apply the sticker when temperatures are above 32°F (0°C).

Note: Do not move stickers after placing them. Do not re-use any stickers if removed.

Note: You can purchase additional stickers through your authorized dealer.

Note: If you previously setup the trailer with the trailer sensor, make sure it is not plugged in before configuring the trailer and placing the sticker.

TRAILER SENSOR INSTALLATION



Trailer Backup Assistance (If Equipped)

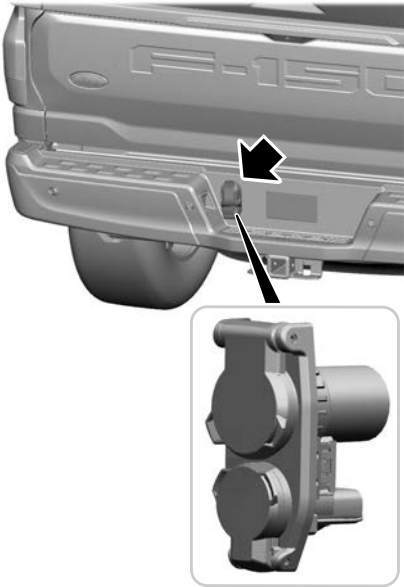

Note: To setup a trailer with a sensor, install the sensor on the trailer and plug the connector into the connector in your bumper prior to configuring the trailer. Trailers that were set up with a sensor still require the sensor to function. To change a trailer to use the sticker, delete the trailer in the system and repeat the trailer setup with the sticker.

CALIBRATING THE SYSTEM

Calibrating the system requires driving forward and turning left or right. Follow the instructions on the touchscreen to complete the calibration process.

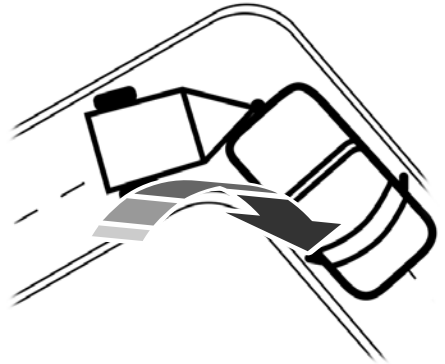

You need to purchase a sensor kit and 7/12 way connector to replace the 7/4 way connector on your vehicle to setup the system with a sensor. See your authorized dealer.

Refer to the instructions included with your trailer sensor for detailed information regarding installation.

Note: Make sure the arrows on the sensor housing are facing up. Mount the sensor to a vertical part of the trailer that pivots when you turn your vehicle. Do not mount to a stationary surface such as the truck side of the trailer hitch.

Note: To calibrate the system, you need an area where you can safely drive forward and turn left or right. An open parking lot is an ideal place to perform the calibration.

Note: Keep the steering wheel straight when instructed to by the touchscreen. If the steering wheel is in a turned position during this instruction, the calibration pauses.

Trailer Backup Assistance (If Equipped)

Note: During calibration, the system determines the trailer length. The system supports trailer lengths of 6–33 ft (1.85–10.05 m) distance from the hitch point to the center of the axle or axles. The system is designed to work with drawbars that have a license plate to hitch ball center measurement of 9–18 in (23–46 cm) when installed. Do not attempt to use drawbars or trailers that have a length outside of this range as the system performance degrades and could cause improper system function.

Note: The touchscreen shows if you are going too slow or fast. Calibration pauses if the speed is outside the required range of 2–9 mph (4–15 km/h).

Note: You need to complete at least a 90° turn, and longer trailers could require a 180° turn. Camera trailer tracking requires the system to locate the hitch ball as well as determine the trailer length. Some trailers could require you to drive straight then turn multiple times before calibration completes. The touchscreen provides instructions and notifies you when calibration completes.

Note: For best results, do not calibrate the system at night when calibrating the system with the sticker.

SWITCHING TRAILER BACKUP ASSISTANCE ON AND OFF



Press the button and use the touchscreen to select the connected trailer.

Note: A trailer must be configured to use trailer backup assistance. See **Configuring the Trailer** (page 437).

Note: If you use the steering wheel when using trailer backup assistance, the system turns off and a message displays in the touchscreen.

Note: If the trailer was connected just prior to turning the system on, you may need to drive forward to initialize the system. Follow the instructions on the touchscreen to activate the system.

Trailer Backup Assistance (If Equipped)

USING THE TRAILER BACKUP ASSISTANCE CONTROLLER

Use the control knob to steer the trailer. Take your hands off the steering wheel and turn the control knob instead. The control knob acts as the steering control for the trailer.



Turn and hold counterclockwise to make the trailer go left.



Turn and hold clockwise to make the trailer go right.

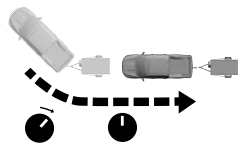

Release the knob when the trailer is moving in the direction you want.

Note: The more you turn the knob, the sharper the trailer turns.

Note: Quickly turning and releasing the knob results in a jerky movement of the vehicle.

Note: You may have to use the knob to correct the trailer direction when attempting to move the trailer straight back under some conditions.

USING THE TRAILER BACKUP ASSISTANCE VIEWS

Up to seven camera views could be available when using trailer backup assistance. Use the view that helps you the most when reversing your vehicle and trailer.

Note: The rear view camera view is available on all vehicles with trailer backup assistance. Additional views are available on vehicles with trailer reverse guidance.



360° camera view. Shows a 360° view on the right-hand side of the touchscreen with a rear camera view on the left-hand side of the touchscreen.

Trailer Backup Assistance (If Equipped)



Rear view camera view. Shows your trailer hitch or what is directly behind your vehicle.



Rear split view camera view. Shows a 180° degree view of what is behind your vehicle.



Bed camera view. Shows the truck bed.

Note: This view also provides a picture-in-picture view.



Trailer AUX camera view. Shows a rear view camera image of what is behind your trailer. You need to separately purchase this camera and have it installed.

Note: This view also provides a picture-in-picture view.



Trailer reverse guidance view. Shows you a view of the sides of your truck and the trailer. In auto mode, this view moves as the trailer moves so that you do not have to adjust the camera as you turn. Left and right arrows let you see other camera views.



Picture-in-picture view. Shows a main view and a secondary view when in bed camera view or trailer AUX camera view.

Note: If you have a 8 in (20 cm) touchscreen, picture-in-picture is off by default. Press the picture-in-picture icon on the touchscreen to switch picture-in-picture view on and off.

Note: If you have a 12 in (30 cm) touchscreen, picture-in-picture is on by default and you cannot switch it off.



Swap. Press to swap between picture-in-picture views.

Auto

Auto. Press to return to auto view.

Note: Auto is the default setting.

Hitch Angle Graphic

The hitch angle graphic shows a small representation of your truck and trailer with visual feedback to help you monitor the trailer. The graphic shows two different colored lines for the trailer hitch angle. A black line shows you where your trailer is in relation to your vehicle. The white line represents the amount the trailer can turn based on knob input.

The graphic shows a yellow and red zone for the hitch angle to warn you of a high angle condition that could require you to pull forward to reduce the hitch angle. The angle limits for each zone vary based on the trailer length.

The yellow zone indicates you are approaching the maximum controllable trailer angle for the system. When the trailer enters this zone, it is more difficult to reduce the trailer turn when backing up. It may be necessary to put your vehicle back into drive (D) and pull forward to get the truck and trailer back to an in-line position.

The red zone indicates you have exceeded the maximum controllable trailer angle for the system. Immediately stop reversing. Put your vehicle into drive (D) and pull forward until the trailer is no longer in the red zone.

Setting the Trailer Angle Limit

1. Press **Features** on the touchscreen.
2. Press **Towing**.
3. Press **Manage trailers**.
4. Press **Pro Trailer Backup Assist**.
5. Press **Trailer Angle Limit**.
6. Press a setting.

Trailer Backup Assistance (If Equipped)

Normal Control Angle

Default setting. This provides a balanced limit that returns from a turn to straight backing with minimal change to the trailer direction.

Max Control Angle

Increases the trailer angle limit close to the maximum controllable angle to allow sharper turns but also causes more change in the trailer direction when straightening out from a turn.

Trailer Backup Assistance (If Equipped)

TRAILER BACKUP ASSISTANCE – TROUBLESHOOTING

TRAILER BACKUP ASSISTANCE – INFORMATION MESSAGES

| Message | Description |
|---|---|
| Detecting Trailer Please Wait... | Displays when the system turns on and is initializing. |
| Pro Trailer Backup Assist™ System is Not Available | A condition exists that prevents the system from turning on. If the message continues to display, visit your authorized dealer to have your vehicle checked. |
| Pro Trailer Backup Assist™ Driving Required to Initialize Steering Press Knob to Exit | The steering system needs to learn internal parameters to fully enable the feature. Drive your vehicle straight forward above 25 mph (40 km/h) for approximately 5 minutes. |
| Pro Trailer Backup Assist™ Stop now Maximum trailer angle Press Knob to Exit | Displays when you reach the maximum controllable trailer angle for the system. Place your vehicle in drive (D) and pull forward to get the truck and trailer back to an in-line position. If this message consistently displays, you may need to repeat the trailer calibration. Delete the trailer from the system and repeat the setup and calibration process. |
| Stop now. Deactivated by trailer angle. | Displays when you exceed the maximum controllable trailer angle for the system. Place your vehicle in drive (D) and pull forward to get your vehicle and trailer back to an in-line position, then activate the system by selecting the connected trailer and following the instructions on the touchscreen. If this message consistently displays, you may need to repeat the trailer setup and calibration. Delete the trailer from the system and repeat the setup and calibration process. |
| Pro Trailer Backup Assist™ Stop Now Take Control of Steering Wheel | Displays when the system can no longer steer the vehicle and you must take over steering. |

Trailer Backup Assistance (If Equipped)

| Message | Description |
|---|--|
| <p>Pro Trailer Backup Assist™ Sensor Not Detected Refer to Owner's Manual Press Knob to Exit</p> | <p>Displays when the system does not detect the sensor. Check the sensor connection, check that there is no damaged wiring between the connector and sensor and check that there is only one sensor connected.</p> <p>If you do not want to use the sensor for this trailer, delete the trailer in the touchscreen then repeat the setup process with the sticker.</p> |
| <p>Pro Trailer Backup Assist™ Trailer Not Detected. Shift to Park Press Knob to Exit</p> | <p>These messages display when the system does not detect the trailer.</p> |
| <p>Pro Trailer Backup Assist™ Trailer Not Detected. Refer to Owner's Manual. Press Knob to Exit</p> | <p>If your trailer is setup with a sticker, make sure the rear camera is clean, and the sticker is clearly visible in the camera image. You can also move the trailer forward or backward to change the trailer position and lighting conditions.</p> <p>If your trailer is setup with a sensor, check that the sensor is correctly installed and the trailer length is within the allowed range.</p> <p>If these messages continue to display, visit your authorized dealer to have your vehicle checked.</p> |

Trailer Backup Assistance (If Equipped)

| Message | Description |
|---|---|
| Pro Trailer Backup Assist™ Trailer Not Detected Pull Forward to Initialize Press Knob to Exit | If your trailer is setup with a sticker, this message displays when the camera system cannot detect the trailer and requires trailer movement to enable trailer detection. Drive forward above 2 mph (3 km/h) to initialize the system. If your trailer is setup with a sensor, this message displays when your vehicle has not moved after the trailer sensor is connected or extended operation below 1 mph (1 km/h). Drive forward above 2 mph (3 km/h) to initialize the system. |
| Pro Trailer Backup Assist™ Stop Now System Not Active Press Knob to Exit | Displays when your vehicle is backing up but the system is not activated. Select the connected trailer on the touchscreen and follow the instructions to activate the system. This message also displays when you back up during the calibration process. |
| Pro Trailer Backup Assist™ Backup Slowly Turn Knob to Steer Press Knob to Exit | Displays when the system turns on and is available to use. |

Trailer Backup Assistance (If Equipped)

TRAILER BACKUP ASSISTANCE – FREQUENTLY ASKED QUESTIONS

What does it mean if the system does not detect a trailer that is setup with a sticker?

- The system could be having trouble identifying the sticker. The system requires a clear view of the sticker placed on the trailer. You must keep the camera lens and sticker clean for the system to correctly operate. If the system cannot initially detect the trailer, it could be necessary for you to change the lighting conditions by moving your vehicle and trailer or waiting until the conditions change. See **Applying the Trailer Reversing Aid Sticker** (page 424). Deleting the trailer and repeating the setup and calibration could improve performance, but some trailers are not compatible with the sticker and camera system. If the system consistently does not detect the trailer with the sticker setup, you may choose to setup the trailer with a sensor.

Note: *The system is designed to be used with the same trailer connection every time you choose the trailer from the touchscreen. When using a different drawbar or a different pin hole on drawbars with more than one, connecting the drawbar to your vehicle affects the trailer position and you may need to repeat the trailer setup and calibration process.*

Why does the trailer not reverse straight?

- The road conditions, such as road camber and road slope, could affect how straight the system can reverse. You can compensate for the trailer drifting to the right or left by slowly turning the knob until the trailer is following your desired path and then holding the knob in that position.
- Other factors, such as the hitch connection or trailer suspension, could affect how straight the system can reverse the trailer. You can compensate for the trailer drifting to the right or left by slowly turning the knob until the trailer is following your desired path and then holding the knob in that position.
- The sensor could be incorrectly installed. Make sure the sensor is correctly installed.

What does it mean if the system remains on one message for an extended time during calibration when setting up the system with the sticker?

- The camera could require cleaning.
- You could have a blocked sticker. Verify the sticker is in the proper location. See **Applying the Trailer Reversing Aid Sticker** (page 424).
- The drawbar could be outside of the allowed range of 4–19 in (10–48 cm).

Trailer Backup Assistance (If Equipped)

- The system could have difficulties recognizing the sticker based on environmental factors. You could need to move to a different area to change the lighting and background or you could need to change the direction you are driving. You could also try setting up the system at a different time of day.
- Some trailers are not compatible with the sticker and camera system. If the issue persists, set up the trailer with a sensor purchased from your authorized dealer. See **Trailer Sensor Installation** (page 424).

What does it mean if the system pauses during calibration?

- There could be steering input or trailer movement during the straight drive portion of the calibration process.

What does it mean if the system displays hold steering steady during turn?

- Part of the calibration process for the sticker setup requires a steady turn. If you are continually moving the steering wheel during the turn, this delays the calibration process. To enable the calibration process, hold the steering wheel at the same position when turning.

What does it mean if the system displays that it is not available?

- There could be a sub-system that the system uses that is not correctly operating. If the system continues to display it is not available, visit your authorized dealer to have your vehicle checked.
- There could be a battery voltage issue. Make sure the battery is correctly charged. If the system continues to display it is not available, visit your authorized dealer to have your vehicle checked.

What does it mean if the system displays that driving is required to initialize steering?

- The steering system needs to learn internal parameters to fully turn on the feature. Drive your vehicle straight forward above 25 mph (40 km/h) for approximately 5 minutes.
- Your vehicle is new, there is a battery voltage issue or you have serviced the steering system.

What does it mean if the system requires you to pull forward to initialize?

- This occurs when the vehicle has not moved during the current key cycle after you connect and select the trailer in the touchscreen, or you operate the system at speeds below 1 mph (1 km/h) for an extended period of time. Drive forward above 2 mph (3 km/h) and the system indicates when it initializes.

Trailer Backup Assistance (If Equipped)

What does it mean if the trailer is at its maximum angle or the system deactivated by trailer angle?

- You are at the maximum controllable trailer angle for the system. Place your vehicle in drive (D) and pull forward to get the truck and trailer back to an in-line position.
- The trailer could need to be recalibrated. Check that the correct trailer is selected in the touchscreen. Verify the sensor is installed according to the instructions included in the sensor kit and check that the drawbar and the trailer dimensions are within the allowed range. Then, delete the trailer from the system and repeat the setup process to calibrate the trailer.
- The drawbar or the trailer dimensions are outside of the supported range. The system is designed to work with drawbars that have a license plate to hitch ball center measurement of 9–18 in (23–46 cm) when installed. The system is designed to work with trailers that have a hitch point to center of the axle or axles measurement of 6–33 ft (1.85–10.05 m). Do not attempt to use drawbars or trailers that have a length outside of this range as the system performance degrades and could cause improper system function.
- The sensor could be incorrectly installed. Make sure the sensor is correctly installed.

What does it mean when the system tells you to take control of the steering wheel?

- You have touched the steering wheel when the system is steering. Avoid touching the wheel during system operation.
- You have exceeded the maximum speed for the feature. The system is no longer steering the vehicle and you must take over steering.
- The system does not detect the trailer. The system is no longer steering the vehicle and you must take over steering.
- An internal condition for system operation is not met that requires your vehicle to return to manual control of the steering.

How do I use a sticker if I have previously setup a trailer with the sensor?

- Disconnect the sensor wiring and add a new trailer to the system and follow the instructions for setup with a sticker. See **Applying the Trailer Reversing Aid Sticker** (page 424). If your vehicle does not support the sticker option, the touchscreen instructs you to install the sensor again.

Trailer Backup Assistance (If Equipped)

Why does the system not detect a sensor?

- There could be an issue with the connection. Make sure that the 12-way connector is fully inserted into the 12-way socket, that the red rubber seal is not visible when the connector is fully inserted and that the wiring harness sensor connection is fully inserted at the trailer sensor.
- The wiring harness could be damaged. Check for damaged wiring between the 12-way connector and the trailer sensor.
- There could be multiple sensors connected to your vehicle. Make sure only one sensor is connected at a time.
- The sensor could be incorrectly installed. Make sure the sensor is installed on a vertical surface with the arrows pointing straight up.

What does it mean if the system remains on one message for an extended time during calibration when setting up the system with the sensor?

- The trailer length could be outside the allowed range. The system is designed to work with trailers that have a hitch point to center of the axle or axles measurement of 6–33 ft (1.85–10.05 m).
- The road surface could be too rough or bumpy. Try calibrating the system on a smoother road surface, such as an open parking lot.
- The sensor could be incorrectly installed. Make sure the sensor is installed on a vertical surface with the arrows pointing straight up.

What does it mean if the system does not detect a trailer when configured with a sensor?

- Verify that you properly connected the sensor. See **Trailer Sensor Installation** (page 424). Repeat calibration on a different route if you have verified sensor installation.

What if I want to use a sensor for the trailer instead of a sticker?

- Install the sensor and connect the sensor wiring before adding the new trailer to the system. You must connect the sensor before you add the trailer. If your vehicle did not come with a sensor, you can purchase one from your authorized dealer.

Trailer Reverse Guidance (If Equipped)

WHAT IS TRAILER REVERSE GUIDANCE

Trailer reverse guidance provides views and graphics on the touchscreen to help you steer your vehicle when you backup a trailer.

HOW DOES TRAILER REVERSE GUIDANCE WORK

Trailer reverse guidance uses a sticker or sensor attached to the trailer to detect the trailer angle relative to the towing vehicle and provides instructions, graphics and camera views on the touchscreen.

TRAILER REVERSE GUIDANCE PRECAUTIONS



WARNING: Driving while distracted can result in loss of vehicle control, crash and injury. We strongly recommend that you use extreme caution when using any device that may take your focus off the road. Your primary responsibility is the safe operation of your vehicle. We recommend against the use of any hand-held device while driving and encourage the use of voice-operated systems when possible. Make sure you are aware of all applicable local laws that may affect the use of electronic devices while driving.



WARNING: This system is an extra driving aid. It does not replace your attention and judgment, or the need to apply the brakes. This system does NOT automatically brake your vehicle. If you fail to press the brake pedal when necessary, you may collide with another vehicle.

Note: The system is not a substitute for safe driving practices. Always be aware of your vehicle and trailer combination, and the surrounding environment.

Note: The system does not detect or prevent your vehicle or trailer from making contact with obstacles in the surrounding environment.

Note: The front end of your vehicle swings out when changing the direction of the trailer.

Note: In certain conditions, the trailer could turn faster or the trailer angle could increase more than anticipated. Always monitor the clearance between the trailer and vehicle and the surroundings.

SETTING UP TRAILER REVERSE GUIDANCE FOR A CONVENTIONAL TRAILER

CONFIGURING THE TRAILER

You must configure a trailer in the system to use trailer reverse guidance. This is a one-time setup process and the system saves the trailer information for the next time you use that trailer.

The system only works with conventional trailers. It does not work with other types including fifth-wheel and gooseneck. The following illustration shows examples of conventional trailers on the left-hand side.

Note: Trailer reverse guidance camera views are available without setting up a trailer. However, complete functionality, including images and automatic view switching, is enabled by setup. Setup is required to enable trailer backup assistance.

Trailer Reverse Guidance (If Equipped)

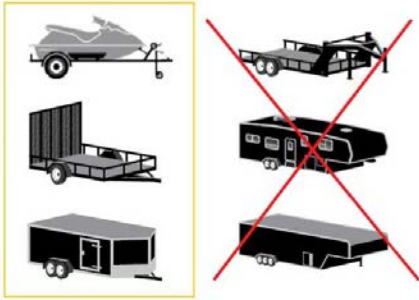

Positioning the Trailer

Hitch the trailer to your vehicle and connect the electrical wiring harness. Check to make sure that the wiring is working. See **Connecting a Trailer** (page 399).



Park your vehicle and hitched trailer on a level surface.

For best results, make sure that your trailer rides level with the ground when you hitch your vehicle. See **Connecting a Trailer** (page 399).



Make sure that the trailer and your vehicle are in line with each other. You can do this by putting the transmission in drive (D) and pulling straight forward.

Configuring the Trailer in the Touchscreen

1. Shift to reverse (R).
2. Press the camera view button.
3. Press the trailer view icon.
4. Press **Add Trailer**.
5. Follow the directions on the touchscreen to enter the trailer name and trailer type, then proceed to the sticker or sensor setup.

Note: Your vehicle has two options for trailer reverse guidance setup. The system defaults to the camera based system. See **Applying the Trailer Reverse Aid Sticker** (page 438). You can also setup the system with the trailer sensor that you can purchase from your authorized dealer. You must connect a sensor to your vehicle to setup the system. See **Trailer Sensor Installation** (page 439).

Note: If you configure the trailer and install a sensor, the system saves the trailer with that sensor information. If you want to use this trailer with the sticker, you need to delete the trailer from the system and repeat the setup process.

APPLYING THE TRAILER REVERSE AID STICKER

Place the sticker in an area visible by the rear view camera. The entire sticker must be within 4–19 in (10–48 cm) from the center of the hitch ball, as shown in the following illustration.

Trailer Reverse Guidance (If Equipped)

TRAILER SENSOR INSTALLATION

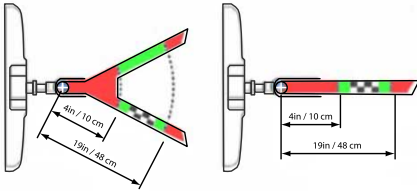

Use the supplied sticker placement card, a tape measure and pen to carefully mark the area to attach the sticker. The sticker is in the back cover pocket of your quick start guide. Make sure the entire sticker is within the green zone between the two arcs or distance markers on the diagram, and is also visible in the rear view camera display.

Once you have found the correct location, place the sticker.

Note: Make sure nothing can obstruct the rear view camera's view of the sticker such as a jack handle or wiring.

Note: Position the sticker on a flat, dry and clean horizontal surface. For best results, apply the sticker when temperatures are above 32°F (0°C).

Note: Do not move stickers after placing them. Do not re-use any stickers if removed.

Note: You can purchase additional stickers through your authorized dealer.

Note: If you previously setup the trailer with the trailer sensor, make sure it is not plugged in before configuring the trailer and placing the sticker.

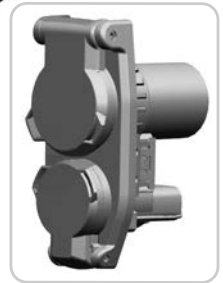
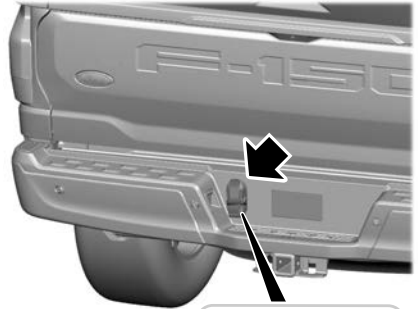

You need to purchase a sensor kit and 7/12 way connector to replace the 7/4 way connector on your vehicle to setup the system with a sensor. See your authorized dealer.

Trailer Reverse Guidance (If Equipped)

Refer to the instructions included with your trailer sensor for detailed information regarding installation.

Note: Make sure the arrows on the sensor housing are facing up. Mount the sensor to a vertical part of the trailer that pivots when you turn your vehicle. Do not mount to a stationary surface such as the truck side of the trailer hitch.

Note: To setup a trailer with a sensor, install the sensor on the trailer and plug the connector into the connector in your bumper prior to configuring the trailer. Trailers that were set up with a sensor still require the sensor to function. To change a trailer to use the sticker, delete the trailer in the system and repeat the trailer setup with the sticker.

CALIBRATING THE SYSTEM

Calibrating the system requires driving forward and turning left or right. Follow the instructions on the touchscreen to complete the calibration process.

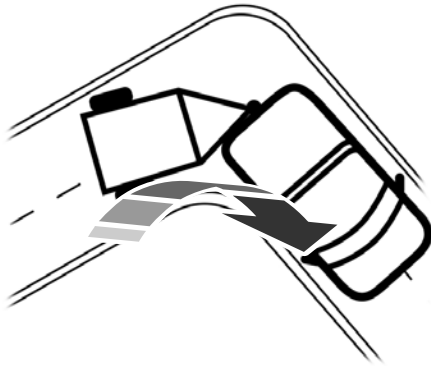

Note: To calibrate the system, you need an area where you can safely drive forward and turn left or right. An open parking lot is an ideal place to perform the calibration.

Note: Keep the steering wheel straight when instructed to by the touchscreen. If the steering wheel is in a turned position during this instruction, the calibration pauses.

Note: During calibration, the system determines the trailer length. The system supports trailer lengths of 6–33 ft (1.85–10.05 m) distance from the hitch point to the center of the axle or axles. The system is designed to work with drawbars that have a license plate to hitch ball center measurement of 9–18 in (23–46 cm) when installed. Do not attempt to use drawbars or trailers that have a length outside of this range as the system performance degrades and could cause improper system function.

Note: The touchscreen shows if you are going too slow or fast. Calibration pauses if the speed is outside the required range of 2–9 mph (4–15 km/h).

Note: You need to complete at least a 90° turn, and longer trailers could require a 180° turn. Camera trailer tracking requires the system to locate the hitch ball as well as determine the trailer length. Some trailers could require you to drive straight then turn multiple times before calibration completes. The touchscreen provides instructions and notifies you when calibration completes.

Note: For best results, do not calibrate the system at night when calibrating the system with the sticker.

SWITCHING TRAILER REVERSE GUIDANCE ON AND OFF

Shift into reverse (R), press the rear camera button to expand the menu, press the trailer icon and use the touchscreen to select the connected trailer.

Trailer Reverse Guidance (If Equipped)

Note: If the trailer was connected just prior to turning the system on, you may need to drive forward to initialize the system. Follow the instructions on the touchscreen to activate the system.

USING TRAILER REVERSE GUIDANCE VIEWS

Up to seven camera views could be available when using trailer reverse guidance. Use the view that helps you the most when reversing your vehicle and trailer.



360° camera view. Shows a 360° view on the right-hand side of the touchscreen with a rear camera view on the left-hand side of the touchscreen.



Rear view camera view. Shows your trailer hitch or what is directly behind your vehicle.



Rear split view camera view. Shows a 180° degree view of what is behind your vehicle.



Bed camera view. Shows the truck bed.

Note: This view also provides a picture-in-picture view.



Trailer AUX camera view. Shows a rear view camera image of what is behind your trailer. You need to separately purchase this camera and have it installed.

Note: This view also provides a picture-in-picture view.



Trailer reverse guidance view. Shows you a view of the sides of your truck and the trailer. In auto mode, this view moves as the trailer moves so that you do not have to adjust the camera as you turn. Left and right arrows let you see other camera views.



Straight backup mode. Shows which way to turn your steering wheel to keep the trailer straight. Use this view when you want to keep your trailer completely in line with your truck.

Note: This view also provides a picture-in-picture view.

Note: It may be helpful to shift your vehicle into drive (D), pull forward and straighten out the vehicle and trailer before engaging straight backup mode.



Picture-in-picture view. Shows a main view and a secondary view when in bed camera view, trailer AUX camera view or straight backup mode.

Note: If you have a 8 in (20 cm) touchscreen, picture-in-picture is off by default. Press the picture-in-picture icon on the touchscreen to switch picture-in-picture view on and off.

Note: If you have a 12 in (30 cm) touchscreen, picture-in-picture is on by default for bed camera view and trailer AUX camera view and cannot be switched off. Press the picture-in-picture icon on the touchscreen to switch picture-in-picture view on and off in straight backup mode.



Swap. Press to swap between picture-in-picture views.



This takes you back to the 360° camera system and out of the trailer reverse guidance feature.



Auto. Press to return to auto view.

Trailer Reverse Guidance (If Equipped)

Note: *Auto mode is the default setting.*

Hitch Angle Graphic

The hitch angle graphic shows a small representation of your truck and trailer with visual feedback to help you monitor the trailer. The graphic shows two different colored lines for the trailer hitch angle. A black line shows you where your trailer is in relation to your vehicle. The white line represents the amount the trailer can turn based on steering wheel position.

The graphic shows a yellow and red zone for the hitch angle to warn you of a high angle condition that could require you to pull forward to reduce the hitch angle. The angle limits for each zone vary based on the trailer length.

The yellow zone indicates you are approaching the maximum controllable trailer angle for the system. When the trailer enters this zone, it is more difficult to reduce the trailer turn when backing up. It may be necessary to put your vehicle back into drive (D) and pull forward to get the truck and trailer back to an in-line position.

The red zone indicates you have exceeded the maximum controllable trailer angle for the system. Immediately stop reversing. Put your vehicle into drive (D) and pull forward until the trailer is no longer in the red zone.

Trailer Reverse Guidance (If Equipped)

TRAILER REVERSE GUIDANCE – TROUBLESHOOTING

TRAILER REVERSE GUIDANCE – INFORMATION MESSAGES

| Message | Description |
|---|---|
| Detecting Trailer Please Wait... | Displays when the system turns on and is initializing. |
| Trailer Reverse Guidance System is Not Available | A condition exists that prevents the system from turning on. If the message continues to display, visit your authorized dealer to have your vehicle checked. |
| Trailer Reverse Guidance Driving Required to Initialize Steering Press OK to Exit | The steering system needs to learn internal parameters to fully enable the feature. Drive your vehicle straight forward above 25 mph (40 km/h) for approximately 5 minutes. |
| Stop now. Deactivated by trailer angle. | Displays when you exceed the maximum controllable trailer angle for the system. Place your vehicle in drive (D) and pull forward to get your vehicle and trailer back to an in-line position, then activate the system by selecting the connected trailer and following the instructions on the touchscreen. If this message consistently displays, you may need to repeat the trailer setup and calibration. Delete the trailer from the system and repeat the setup and calibration process. |
| Trailer Reverse Guidance Sensor Not Detected Refer to Owner's Manual Press OK to Exit | Displays when the system does not detect the sensor. Check the sensor connection, check that there is no damaged wiring between the connector and sensor and check that there is only one sensor connected. If you do not want to use the sensor for this trailer, delete the trailer in the touchscreen then repeat the setup process with the sticker. |

Trailer Reverse Guidance (If Equipped)

| Message | Description |
|---|--|
| Trailer Reverse Guidance Trailer Not Detected. Refer to Owner's Manual. Press OK to Exit | <p>Displays when the system does not detect the trailer.</p> <p>If your trailer is setup with a sticker, make sure the rear camera is clean, and the sticker is clearly visible in the camera image. You can also move the trailer forward or backward to change the trailer position and lighting conditions.</p> <p>If your trailer is setup with a sensor, check that the sensor is correctly installed and the trailer length is within the allowed range.</p> <p>If this message continues to display, visit your authorized dealer to have your vehicle checked.</p> |
| Trailer Reverse Guidance Trailer Not Detected Pull Forward to Initialize Press OK to Exit | <p>Displays when your vehicle has not moved after the trailer sensor is connected or extended operation below 1 mph (1 km/h). Drive forward above 2 mph (3 km/h) to initialize the system.</p> |

Trailer Reverse Guidance (If Equipped)

TRAILER REVERSE GUIDANCE – FREQUENTLY ASKED QUESTIONS

What does it mean if the system does not detect a trailer that is setup with a sticker?

- The system could be having trouble identifying the sticker. The system requires a clear view of the sticker placed on the trailer. You must keep the camera lens and sticker clean for the system to correctly operate. If the system cannot initially detect the trailer, it could be necessary for you to change the lighting conditions by moving your vehicle and trailer or waiting until the conditions change. See **Applying the Trailer Reverse Aid Sticker** (page 438). Deleting the trailer and repeating the setup and calibration could improve performance, but some trailers are not compatible with the sticker and camera system. If the system consistently does not detect the trailer with the sticker setup, you may choose to setup the trailer with a sensor.

Note: *The system is designed to be used with the same trailer connection every time you choose the trailer from the touchscreen. When using a different drawbar or a different pin hole on drawbars with more than one, connecting the drawbar to your vehicle affects the trailer position and you may need to repeat the trailer setup and calibration process.*

Why does the trailer not reverse straight?

- The road conditions, such as road camber and road slope, could affect how straight the system can reverse. You can compensate for the trailer drifting to the right or left by slowly turning the knob until the trailer is following your desired path and then holding the knob in that position.
- Other factors, such as the hitch connection or trailer suspension, could affect how straight the system can reverse the trailer. You can compensate for the trailer drifting to the right or left by slowly turning the knob until the trailer is following your desired path and then holding the knob in that position.
- The sensor could be incorrectly installed. Make sure the sensor is correctly installed.

What does it mean if the system remains on one message for an extended time during calibration when setting up the system with the sticker?

- The camera could require cleaning.
- You could have a blocked sticker. Verify the sticker is in the proper location. See **Applying the Trailer Reverse Aid Sticker** (page 438).
- The drawbar could be outside of the allowed range of 4–19 in (10–48 cm).

Trailer Reverse Guidance (If Equipped)

- The system could have difficulties recognizing the sticker based on environmental factors. You could need to move to a different area to change the lighting and background or you could need to change the direction you are driving. You could also try setting up the system at a different time of day.
- Some trailers are not compatible with the sticker and camera system. If the issue persists, set up the trailer with a sensor purchased from your authorized dealer. See **Trailer Sensor Installation** (page 439).

What does it mean if the system pauses during calibration?

- There could be steering input or trailer movement during the straight drive portion of the calibration process.

What does it mean if the system displays hold steering steady during turn?

- Part of the calibration process for the sticker setup requires a steady turn. If you are continually moving the steering wheel during the turn, this delays the calibration process. To enable the calibration process, hold the steering wheel at the same position when turning.

What does it mean if the system displays that it is not available?

- There could be a sub-system that the system uses that is not correctly operating. If the system continues to display it is not available, visit your authorized dealer to have your vehicle checked.
- There could be a battery voltage issue. Make sure the battery is correctly charged. If the system continues to display it is not available, visit your authorized dealer to have your vehicle checked.

What does it mean if the system displays that driving is required to initialize steering?

- The steering system needs to learn internal parameters to fully turn on the feature. Drive your vehicle straight forward above 25 mph (40 km/h) for approximately 5 minutes.
- Your vehicle is new, there is a battery voltage issue or you have serviced the steering system.

What does it mean if the system requires you to pull forward to initialize?

- This occurs when the vehicle has not moved during the current key cycle after you connect and select the trailer in the touchscreen, or you operate the system at speeds below 1 mph (1 km/h) for an extended period of time. Drive forward above 2 mph (3 km/h) and the system indicates when it initializes.

Trailer Reverse Guidance (If Equipped)

What does it mean if the trailer is at its maximum angle or the system deactivated by trailer angle?

- You are at the maximum controllable trailer angle for the system. Place your vehicle in drive (D) and pull forward to get the truck and trailer back to an in-line position.
- The trailer could need to be recalibrated. Check that the correct trailer is selected in the touchscreen. Verify the sensor is installed according to the instructions included in the sensor kit and check that the drawbar and the trailer dimensions are within the allowed range. Then, delete the trailer from the system and repeat the setup process to calibrate the trailer.
- The drawbar or the trailer dimensions are outside of the supported range. The system is designed to work with drawbars that have a license plate to hitch ball center measurement of 9–18 in (23–46 cm) when installed. The system is designed to work with trailers that have a hitch point to center of the axle or axles measurement of 6–33 ft (1.85–10.05 m). Do not attempt to use drawbars or trailers that have a length outside of this range as the system performance degrades and could cause improper system function.
- The sensor could be incorrectly installed. Make sure the sensor is correctly installed.

What does it mean when the system tells you to take control of the steering wheel?

- You have touched the steering wheel when the system is steering. Avoid touching the wheel during system operation.
- You have exceeded the maximum speed for the feature. The system is no longer steering the vehicle and you must take over steering.
- The system does not detect the trailer. The system is no longer steering the vehicle and you must take over steering.
- An internal condition for system operation is not met that requires your vehicle to return to manual control of the steering.

How do I use a sticker if I have previously setup a trailer with the sensor?

- Disconnect the sensor wiring and add a new trailer to the system and follow the instructions for setup with a sticker. See **Applying the Trailer Reverse Aid Sticker** (page 438). If your vehicle does not support the sticker option, the touchscreen instructs you to install the sensor again.

Trailer Reverse Guidance (If Equipped)

Why does the system not detect a sensor?

- There could be an issue with the connection. Make sure that the 12-way connector is fully inserted into the 12-way socket, that the red rubber seal is not visible when the connector is fully inserted and that the wiring harness sensor connection is fully inserted at the trailer sensor.
- The wiring harness could be damaged. Check for damaged wiring between the 12-way connector and the trailer sensor.
- There could be multiple sensors connected to your vehicle. Make sure only one sensor is connected at a time.
- The sensor could be incorrectly installed. Make sure the sensor is installed on a vertical surface with the arrows pointing straight up.

What does it mean if the system remains on one message for an extended time during calibration when setting up the system with the sensor?

- The trailer length could be outside the allowed range. The system is designed to work with trailers that have a hitch point to center of the axle or axles measurement of 6–33 ft (1.85–10.05 m).
- The road surface could be too rough or bumpy. Try calibrating the system on a smoother road surface, such as an open parking lot.
- The sensor could be incorrectly installed. Make sure the sensor is installed on a vertical surface with the arrows pointing straight up.

What does it mean if the system does not detect a trailer when configured with a sensor?

- Verify that you properly connected the sensor. See **Trailer Sensor Installation** (page 439). Repeat calibration on a different route if you have verified sensor installation.

What if I want to use a sensor for the trailer instead of a sticker?

- Install the sensor and connect the sensor wiring before adding the new trailer to the system. You must connect the sensor before you add the trailer. If your vehicle did not come with a sensor, you can purchase one from your authorized dealer.

Driving Hints

OFF-ROAD DRIVING

WHAT IS OFF-ROAD DRIVING

Off-road driving is driving your vehicle on unsurfaced roads or trails, made from dirt, rocks, sand and mud.

OFF-ROAD DRIVING PRECAUTIONS - RAPTOR



WARNING: If you continue to drive your vehicle when the engine is overheating, the engine could stop without warning. Failure to follow this instruction could result in the loss of control of your vehicle.

Before going off-road driving, consult with all the appropriate government entities to determine where you are legally allowed to operate your vehicle and what permits or registrations are required to do so.

Inspect your vehicle before and after any off-road driving.

Familiarize yourself with the dimensions of your vehicle including approach angles, breakover angles, and ground clearance.

Also familiarize yourself with the features of your vehicle. Some of these features such as drive modes and cameras can improve your off-road driving experience.

Secure loose objects inside your vehicle and in the cargo area.

BASIC OFF-ROAD DRIVING TECHNIQUES

Off-road Driving Hints

Before taking your vehicle off-roading, a basic vehicle inspection should be done to make sure that the vehicle is in top working condition. It is always recommended that at least two vehicles are used while off-roading. The buddy system helps make sure that help is close at hand should a vehicle become stuck or damaged. It is also wise to take supplies such as a first aid kit, supply of water, tow strap, cell or satellite phone with you any time an off-road excursion is planned.

1. Grip the steering wheel with thumbs on the outside of the rim. This will reduce the risk of injury due to abrupt steering wheel motions that occur when negotiating rough terrain.
2. Throttle, brake and steering inputs should be made in a smooth and controlled manner. Sudden inputs to the controls can cause loss of traction or upset the vehicle, especially while on loose terrain or while crossing obstacles such as rocks or logs.
3. Look ahead on your route noting upcoming obstacles, or any other factors which may indicate a change in available traction, and adjust the vehicle speed and route accordingly.
4. When driving off-road, if the front or rear suspension is bottoming out and/or excessive contact with the skid-plates is encountered, reduce vehicle speed to avoid potential damage to the vehicle.
5. When with other vehicles, it is recommended that communication is used, and the lead vehicle notify other vehicles of obstacles that could cause potential vehicle damage.

Driving Hints

6. Always keep available ground clearance in mind and pick a route that minimizes the risk of catching the underside of the vehicle on an obstacle.
 7. When negotiating low speed obstacles, applying light brake pressure in conjunction with the throttle will help prevent the vehicle from jerking and will allow you to negotiate the obstacle in a more controlled manner. Using 4L will also help with this.
 8. Off-roading requires a high degree of concentration. Even if your local law does not prohibit alcohol use while driving off-road, Ford strongly recommends against drinking if you plan to off-road.
- Always attempt to climb a steep hill along the fall line of the slope and not diagonally.
 - If the vehicle is unable to make it up the hill, DO NOT attempt to turn back down the slope. Place the vehicle in low range and slowly back down in reverse.
 - When descending a steep slope, select low gear and engage hill descent control. Use the throttle and brake pedals to control your descent speed.

Note: Hill descent control is functional in reverse and should be used in this situation.

Crossing Obstacles

- Review the path ahead before attempting to cross any obstacle. It is best if the obstacle is reviewed from outside the vehicle so that there is a good understanding of terrain condition both in front of and behind the obstacle.
- Approach obstacles slowly.
- If a large obstacle such as a rock cannot be avoided, choose a path that places the rock directly under the tire rather than the undercarriage of the vehicle. This will help prevent damage to the vehicle.
- Ditches and washouts should be crossed at a 45° angle, allowing each wheel to independently cross the obstacle.

Hill Climbing



WARNING: Extreme care should be used when steering the vehicle in reverse down a slope so as not to cause the vehicle to swerve out of control.

BASIC OFF-ROAD DRIVING TECHNIQUES - RAPTOR

Grip the steering wheel with your thumbs on the outside of the rim. This reduces the risk of injury due to abrupt steering wheel motions that occur when negotiating rough terrain.

If you are driving in a dusty area, be sure to leave ample distance between your vehicle and any other vehicles to allow for adequate vision.

DRIVING OFF-ROAD - RAPTOR

Driving In Snow and Ice



WARNING: Do not become overconfident in the ability of four-wheel drive vehicles. Although a four-wheel drive vehicle may accelerate better than a two-wheel drive vehicle in low traction situations, it won't stop any faster than two-wheel drive vehicles. Always drive at a safe speed.

Make sure you allow sufficient distance between your vehicle and other vehicles for stopping.

Driving Hints

Driving In Sand

When driving over sand, try to keep all four wheels on the most solid area of the trail.

Driving In Mud

Be cautious of sudden changes in vehicle speed or direction when you are driving in mud.

After driving through mud, clean your vehicle. Excess mud stuck on the wheels and tires and rotating components can cause an imbalance and result in damage.

Note: *The vehicle brakes are less effective when wet or muddy.*

Driving Over Rocks and Gravel

Never attempt to straddle a rock that is large enough to strike your axles or undercarriage.

Leave a generous gap between your vehicle and other vehicles to minimize the risk of damage. Avoid dust clouds as they reduce visibility.

Climbing A Hill



WARNING: Extreme care should be used when steering the vehicle in reverse down a slope so as not to cause the vehicle to swerve out of control.

Do not drive over the crest of a hill without seeing what conditions are on the other side. Do not drive in reverse over a hill without the aid of an observer.

Note: *Avoid turning on steep slopes or hills. A danger lies in losing traction, slipping sideways and possible vehicle roll over.*

Note: *Too much acceleration can cause the tires to slip, spin or lose traction, resulting in loss of vehicle control.*

Driving Through Water



WARNING: Do not attempt to cross a deep, fast flowing body of water. Failure to follow this instruction could result in the loss of control of your vehicle, personal injury or death.

The key to a safe crossing is the water depth, current and bottom of the water's condition. On soft bottoms, the vehicle sinks in, effectively increasing the water level on the vehicle. Make sure to consider this when determining the depth of water.

Determine the depth and speed of the current before attempting a water crossing.

Be aware that obstacles and debris could be beneath the water's surface.

Note: *Cross flowing water at an angle heading slightly upstream.*

Note: *Tread lightly and avoid damage to the environment.*

Water can cause permanent damage that may not be covered by your vehicle warranty. See **Driving Through Water Limitations** (page 453).

Note: *Failure to follow the recommended speeds can result in vehicle damage.*

Muddy waters can reduce the cooling system effectiveness by depositing debris into the radiator.

High currents even in shallow water can wash the dirt out from around your tires or push your vehicle across slippery rocks or surfaces.

Do not cross any body of water that is fast flowing and rising.

Driving Hints

Vehicles used to traverse water should be periodically inspected for signs of water ingestion in all of the vehicle's fluids. If water is found inside your vehicle fluids, service your vehicle or see an authorized dealer.

Avoid Getting High-Centered

Always keep available ground clearance in mind and pick a route that minimizes the risk of catching the underside of the vehicle on an obstacle and getting high-centered.

Freeing A Stuck Vehicle



WARNING: Do not spin the wheels at over 34 mph (55 km/h). The tires may fail and injure a passenger or bystander.

Recovery hooks are mounted to the vehicle's structure and are used to pull out the vehicle from a surface or location when stuck. Recover your vehicle using various towing apparatus attached to your recovery hook such as winch, open hook, or strap.

Note: Do not use recovery hooks to recreationally tow your vehicle. See **Recreationally Towing Your Vehicle** (page 469).

Note: Do not rock your vehicle if the engine is not at normal operating temperature as damage to the transmission could occur.

Note: Do not rock your vehicle for more than a minute as damage to the transmission and tires could occur or the engine could overheat.

If you are unable to free your vehicle call roadside assistance. See **Roadside Assistance** (page 462).

Crossing A Ravine, Gully, Ditch, Washout Or Rut

Review the path ahead before attempting to cross any obstacle.

Driving Over Logs

Review the path ahead before attempting to cross any obstacle.

DRIVING YOUR VEHICLE AT HIGH SPEEDS - RAPTOR

If you plan on using your vehicle for severe, high speed off-road use, we recommend the following:

- Equipping your vehicle with the safety equipment appropriate for off-road recovery.
- Using personal safety equipment, including a certified helmet and approved neck restraint device.
- Doing a low speed reconnaissance run in unfamiliar areas to become aware of any obstacles that you could encounter.

Your vehicle can incur damage if driven beyond its capabilities. Skid plates, shock guards and running boards are designed to help limit damage to vital components and exterior finishes, but cannot prevent all damage if driven in extreme off-road conditions. Damage to skid plates, shock guards, running boards and exterior finishes as well as bent, cracked or broken body, frame and chassis components may not be covered by warranty.

Driving Hints

DRIVING THROUGH WATER LIMITATIONS - RAPTOR

| Model | Maximum Wading Depth |
|-------|----------------------|
| All. | 32 in (810 mm) |

When you are driving through water do not exceed 4 mph (7 km/h).

WATER WADING



WARNING: Do not attempt to cross a deep, fast flowing body of water. Failure to follow this instruction could result in the loss of control of your vehicle, personal injury or death.

As the water depth increases, you must reduce your vehicle speed to avoid potential vehicle damage.



- Always determine the depth before attempting a water crossing. Never drive through water that is higher than the bottom of the wheel hubs.
- Slowly proceed and avoid splashing water any more than is necessary.

- Be aware that obstacles and debris may be beneath the water's surface.
- Keep the doors fully closed during the water crossing.
- After driving through water and as soon as it is safe to do so check the brakes, horn, lights, and steering wheel to confirm those systems are functioning properly.

Note: Engine damage can occur if water enters the air filter.

OFF-ROAD DRIVING AIDS - RAPTOR

Selecting an Off-Road Drive Mode

Using the appropriate drive mode increases your vehicle's control. See **Drive Mode Control** (page 350).

Using Four-Wheel Drive

Your vehicle has a four-wheel drive system that offers various modes to help you optimize traction on any off-road surface. See **Four-Wheel Drive** (page 269).

Using the Cameras Off-Road

Use the 360 degree camera to enhance your off-road experience. See **360 Degree Camera** (page 321).

Using the Rear Differential Lock

When engaged, the rear differential lock provides additional traction to your vehicle by forcing the two rear wheels to turn at the same speed.

Note: Rear differential lock is only available when the vehicle is in 4H or 4L. See **Electronic Locking Differential** (page 279).

Driving Hints

Using Trail Control

Trail Control provides you the ability to maneuver the vehicle without using the throttle and brake pedals.

The system controls acceleration and braking in difficult off-road environments, which allows you to focus on steering. See **Trail Control** (page 303).

Trail Control Performance:

- Manages wheel slip to maximize traction.
- Provides braking to maximize traction in descents.

Using Trail One Pedal Drive (if

Equipped)

Trail one pedal drive allows you to accelerate and brake using only the accelerator pedal.

Use this when driving over large obstacles, such as rocks or logs, to help maintain a constant vehicle speed.

In 4H, the system offers lift pedal braking and auto hill hold functionality. See **What Is Trail One Pedal Drive** (page 304).

Note: *Trail one pedal drive is only available when the vehicle is in 4H or 4L.*

AFTER DRIVING YOUR VEHICLE OFF-ROAD



WARNING: After off-road use, before returning to the road, check the wheels and tires for damage. Off-road use may cause damage to your wheels and tires that can lead to tire failure, loss of vehicle control, serious injury or death.



WARNING: Always re-inflate tires to recommended tire pressures before the vehicle is operated on-road. The recommended pressure is located on the tire label or safety certification label, located on the B-pillar, inside the driver's door.

Driving off-road places more stress on your vehicle than most on-road driving. After driving off-road check for damage to your vehicle and, if necessary, have your vehicle fixed as soon as possible.

Inspect the underbody of your vehicle by checking tires, body structure, steering, suspension, and exhaust system for damage.

Check the radiator for mud and debris and clean as needed.

Remove accumulations of plants or brush. These things could be a fire hazard or hide damage to the fuel lines, brake hoses, and propeller shafts.

After extended operation in mud, sand, water, or similar dirty conditions, inspect the underbody and clean your vehicle as soon as possible.

If you experience unusual vibration after driving in mud, slush or similar conditions, check the wheels for impacted material. Impacted material can cause vibrations while driving and wheel imbalance. Remove the material to resolve the problem.

Driving Hints

AFTER DRIVING YOUR VEHICLE OFF-ROAD - RAPTOR



WARNING: After off-road use, before returning to the road, check the wheels and tires for damage. Off-road use may cause damage to your wheels and tires that can lead to tire failure, loss of vehicle control, serious injury or death.



WARNING: Always re-inflate tires to recommended tire pressures before the vehicle is operated on-road. The recommended pressure is located on the tire label or safety certification label, located on the B-pillar, inside the driver's door.

Driving off-road places more stress on your vehicle than most on-road driving. After driving off-road, check for damage and, if necessary, have your vehicle repaired by an authorized dealer.

Inspect the underbody of your vehicle by checking tires, body structure, steering, suspension, and exhaust system for damage.

Check the radiator for mud and debris and clean as needed.

Remove accumulations of plants or brush. These things could be a fire hazard or hide damage to the fuel lines, brake hoses, and propeller shafts.

After operation in mud, sand, water, or similar dirty conditions, inspect the underbody and clean your vehicle.

COLD WEATHER PRECAUTIONS

The functional operation of some components and systems can be affected at temperatures below approximately -13°F (-25°C).

DRIVING ON SNOW AND ICE



WARNING: If you are driving in slippery conditions that require tire chains or cables, then it is critical that you drive cautiously. Keep speeds down, allow for longer stopping distances and avoid aggressive steering to reduce the chances of a loss of vehicle control which can lead to serious injury or death. If the rear end of your vehicle slides while cornering, steer in the direction of the slide until you regain control of your vehicle.

On ice and snow, you should drive more slowly than usual. Your vehicle has a four wheel anti-lock brake system, do not pump the brake pedal. See **Anti-Lock Braking System Limitations** (page 286).

BREAKING-IN

Your vehicle requires a break-in period. For the first 1,000 mi (1,600 km), avoid driving at high speeds, heavy braking, aggressive shifting or using your vehicle to tow. During this time, your vehicle may exhibit some unusual driving characteristics.

DRIVING ECONOMICALLY

The following helps to improve fuel consumption:

- Drive smoothly, accelerate gently and anticipate the road ahead to avoid heavy braking.
- Regularly check your tire pressures and make sure that they are inflated to the correct pressure.
- Follow the recommended maintenance schedule and carry out the recommended checks.

Driving Hints

- Plan your journey and check the traffic before you set off. It is more efficient to combine errands into a single trip whenever possible.
- Avoid idling the engine in cold weather or for extended periods. Start the engine only when you are ready to set off.
- Do not carry unnecessary weight in your vehicle as extra weight wastes fuel.
- Do not add unnecessary accessories to the exterior of your vehicle, for example running boards. If you use a roof rack, remember to fold it down or remove it when not in use.
- Do not shift into neutral when you are braking or when your vehicle is slowing down.
- Shut all windows when driving at high speeds.
- Switch off all electric systems when not in use, for example air conditioning. Make sure that you unplug any accessories from the auxiliary power points when not in use.

DRIVING IN SPECIAL CONDITIONS

EMERGENCY MANEUVERS

In an unavoidable emergency where you must make a sudden sharp maneuver, turn the steering wheel only as rapidly and as far as required to avoid the emergency. Apply smooth pressure to the accelerator pedal or brake pedal as needed. Avoid abrupt steering, acceleration and braking changes. Abrupt changes could increase the risk of vehicle roll over, loss of vehicle control and personal injury. If possible, use any available road surfaces to bring your vehicle under control.

FLOOR MATS



WARNING: Use a floor mat designed to fit the footwell of your vehicle that does not obstruct the pedal area. Failure to follow this instruction could result in the loss of control of your vehicle, personal injury or death.



WARNING: Pedals that cannot move freely can cause loss of vehicle control and increase the risk of serious personal injury.



WARNING: Secure the floor mat to both retention devices so that it cannot slip out of position and interfere with the pedals. Failure to follow this instruction could result in the loss of control of your vehicle, personal injury or death.



WARNING: Do not place additional floor mats or any other covering on top of the original floor mats. This could result in the floor mat interfering with the operation of the pedals. Failure to follow this instruction could result in the loss of control of your vehicle, personal injury or death.



WARNING: Always make sure that objects cannot fall into the driver foot well while your vehicle is moving. Objects that are loose can become trapped under the pedals causing a loss of vehicle control.

Driving Hints



To install floor mats that have eyelets, position the floor mat eyelet over the retention post and press down to lock in position. Repeat for all eyelets on the floor mat.

To remove the floor mats, reverse the installation procedure.

Note: *Regularly check the floor mats to make sure they are secure.*

Snow Plowing - Vehicles Without: Snow Plow Mode

SNOW PLOWING PRECAUTIONS

Your vehicle is not approved for snow plowing. Never snow plow with your vehicle.

Snow Plowing - Vehicles With: Snow Plow Mode

SNOW PLOWING PRECAUTIONS



WARNING: Modifying or adding equipment to the front of your vehicle could affect the performance of the airbag system, increasing the risk of injury. This includes the hood, bumper system, frame, front body structure, tow hooks, hood pins, push bar and snowplows.



WARNING: Do not attempt to service, repair, or modify the supplementary restraint system or associated components. Failure to follow this instruction could result in personal injury or death.



WARNING: All occupants of your vehicle, including the driver, should always properly wear their seatbelts, even when an airbag supplemental restraint system is provided. Failure to properly wear your seatbelt could seriously increase the risk of injury or death.



WARNING: Do not spin the wheels at over 34 mph (55 km/h). The tires may fail and injure a passenger or bystander.

Note: Look for an alterer's label on your vehicle from the snowplow installer certifying that the installation meets all applicable Federal Motor Vehicle Safety Standards (FMVSS).

Note: Federal and some local regulations require additional exterior lamps for snowplow-equipped vehicles. Contact an authorized dealer for additional information.

Note: Do not remove or defeat the tripping mechanisms designed into the snow removal equipment by its manufacturer. Doing so could cause damage to your vehicle and the snow removal equipment as well as possible airbag deployment.

OPERATING YOUR VEHICLE WITH A SNOWPLOW

Weight limits and guidelines for selecting and installing the snowplow are in the Ford Truck Body Builders Layout Book. For additional information, visit www.fordbbas.com.

A typical snowplow installation affects the following:

- Front gross axle weight rating. See **What Is the Gross Axle Weight Rating** (page 389).
- Gross vehicle weight rating. See **What Is the Gross Vehicle Weight Rating** (page 389).
- Braking and steering.
- Front wheel toe. See the **Ford Workshop Manual**.
- Headlight aim. See **Adjusting the Headlamps** (page 497).
- Tire air pressure. See **Information on the Tire Sidewall** (page 520).

Note: Do not exceed the front gross axle weight rating or gross vehicle weight rating.

Note: Your vehicle may require rear ballast weight for proper braking and steering.

Your vehicle has a driver and passenger airbag supplemental restraint system. The supplemental restraint system activates in certain frontal and offset frontal collisions when the vehicle sustains sufficient longitudinal deceleration.

Snow Plowing - Vehicles With: Snow Plow Mode

When operating your vehicle with a snowplow:

- Do not exceed 45 mph (72 km/h).
- Your engine could run at a higher temperature than normal.
 - If you are driving more than 15 mi (24 km) at temperatures above freezing, angle the plow blade either full left or full right to provide maximum airflow to the radiator.
 - If you are driving less than 15 mi (24 km) at speeds up to 45 mph (72 km/h) in cold weather, you do not need to worry about blade position to provide maximum airflow.
- Shift to **4L** when plowing in small areas at speeds below 5 mph (8 km/h).
- Shift to **4H** when plowing larger areas or light snow at higher speeds above 5 mph (8 km/h). Do not exceed 15 mph (24 km/h).
- Do not shift the transmission from a forward gear to reverse (R) until the engine is at idle and the wheels have stopped.

Note: Careless or high-speed driving when snowplowing, which results in significant vehicle decelerations, can deploy the airbag. Such driving also increases the risk of accidents.

Note: Drive your vehicle at least 500 mi (800 km) before using your vehicle for snowplowing.

Note: Follow the severe duty schedule for engine oil and transmission fluid change intervals. See **Special Operating Conditions Scheduled Maintenance** (page 648).

SNOWPLOW MODE

WHAT IS SNOWPLOW MODE

Snowplow mode reduces vehicle electrical load to allow the electrical system to have sufficient power to support residential snowplow use.

SWITCHING SNOWPLOW MODE ON AND OFF

Vehicles receive a physical button in the instrument panel or an option in the SYNC menu to enable snowplow mode.

Snowplow mode does not remember the setting when you switch your vehicle off. You must re-enable the mode every time you wish to use it.

The following features turn off and are disabled in snowplow mode and cannot be turned back on until snowplow mode is switched off:

- 120 V inverter.
- Fog lamps.
- Heated and cooled front seats.

The body module also activates the snowplow relay that provides power to aftermarket snowplow controls.

Note: The electrical system supports the addition of a residential snowplow of up to 60 A continuous, and snowplow lights of up to 20 A continuous using snowplow mode. The system does not support snowplow usage with additional electrical aftermarket accessories.

Push Button (If Equipped)

Press the snowplow button on the instrument panel to switch on snowplow mode. The snowplow button illuminates and a message displays.

Snow Plowing - Vehicles With: Snow Plow Mode

Press the snowplow button or switch off the vehicle to switch off snowplow mode.

Using SYNC (If Equipped)

1. Press **Features** on the touchscreen.
2. Press **Snow Plow Mode**.
3. Switch **Snow Plow Mode** on or off.

Crash and Breakdown Information

ROADSIDE ASSISTANCE

Vehicles Sold in the United States: Getting Roadside Assistance

To fully assist you should you have a vehicle concern, Ford Motor Company offers a complimentary roadside assistance program. This program is separate from the New Vehicle Limited Warranty.

The service is available:

- 24 hours a day, seven days a week.
- For the coverage period supplied with your vehicle.

Roadside Assistance covers:

- A flat tire change with a good spare (except vehicles supplied with a tire inflation kit).
- Battery jump start.
- Lock-out assistance (key replacement cost is the customer's responsibility).
- Fuel delivery — independent service contractors, if not prohibited by state, local or municipal law, shall deliver up to 2 gal (8 L) of gasoline or 5 gal (20 L) of diesel fuel to a disabled vehicle. Roadside assistance limits fuel delivery service to two no-charge occurrences within a 12-month period.
- Winch out — available within 100 ft (30 m) of a paved or county maintained road, no recoveries.

- Towing — independent service contractors, if not prohibited by state, local or municipal law, shall tow Ford eligible vehicles to an authorized dealer within 35 mi (56 km) of the disablement location or to the nearest authorized dealer. If a member requests a tow to an authorized dealer that is more than 35 mi (56 km) from the disablement location, the member shall be responsible for any mileage costs in excess of 35 mi (56 km).
- Roadside Assistance includes up to \$200 for a towed trailer if the disabled eligible vehicle requires service at the nearest authorized dealer. If the towing vehicle is operational but the trailer is not, then the trailer does not qualify for any roadside services.

Vehicles Sold in the United States: Using Roadside Assistance

Complete the roadside assistance identification card and place it in your wallet for quick reference. This card is in the Owner's Manual kit.

United States vehicle customers who require Roadside Assistance, call 1-800-241-3673.

If you need to arrange roadside assistance for yourself, Ford Motor Company reimburses a reasonable amount for towing to the nearest dealership within 35 mi (56 km). To obtain reimbursement information, United States vehicle customers call 1-800-241-3673. Customers need to submit their original receipts.

Crash and Breakdown Information

Vehicles Sold in Canada: Getting Roadside Assistance

To fully assist you should you have a vehicle concern, Ford Motor Company of Canada, Limited offers a complimentary roadside assistance program. This program is eligible within Canada or the continental United States.

The service is available 24 hours a day, seven days a week.

This program is separate from the New Vehicle Limited Warranty, but the coverage is concurrent with the powertrain coverage period of your vehicle. Canadian roadside coverage and benefits may differ from the U.S. coverage.

If you require more information, please call us in Canada at 1-800-665-2006, or visit our website at www.ford.ca.

HIGH VOLTAGE BATTERY VEHICLE PRECAUTIONS - HYBRID ELECTRIC VEHICLE (HEV)

In the event of damage or fire involving an electric vehicle or hybrid-electric vehicle:

- Assume the high-voltage battery and associated components are energized and fully charged.
- Physical damage to the vehicle or high-voltage battery could result in immediate or delayed release of toxic, flammable gases and fire.

Crashes

A crash or impact significant enough to require an emergency response for conventional vehicles would also require the same response for an electric or hybrid-electric vehicle.

If Possible:

1. Move your vehicle to a safe, nearby location and remain on the scene.
2. Roll down the windows before you switch your vehicle off.
3. Place your vehicle in park (P), apply the parking brake, switch off the vehicle, turn on the hazard flashers and move the key at least 16 ft (5 m) away from the vehicle.

Always:

- Call emergency assistance if needed and advise that an electric or hybrid-electric vehicle is involved.
- Avoid contact with leaking fluids and gases, and remain out of the way of oncoming traffic until emergency responders arrive.
- When emergency responders arrive, tell them that the vehicle involved is an electric vehicle or hybrid-electric vehicle.

Fires

As with any vehicle, call emergency assistance immediately if you see sparks, smoke or flames coming from the vehicle. Remain a safe distance from the vehicle and try to stay clear of the smoke.

1. Exit the vehicle immediately.
2. Advise emergency assistance that an electric or hybrid-electric vehicle is involved.
3. As with any vehicle fire, do not inhale smoke, vapors or gas from the vehicle, as they may be hazardous.

Crash and Breakdown Information

Post-Incident

1. Do not store a severely damaged vehicle with a lithium-ion battery inside a structure or within 50 ft (15 m) of any structure or vehicle.
2. Make sure that passenger and luggage compartments remain ventilated.
3. As with any vehicle, call emergency assistance immediately if you see sparks, smoke or flames coming from the vehicle.

SWITCHING THE HAZARD FLASHERS ON AND OFF



The hazard flasher button is on the instrument panel. Press the button to switch the hazard flashers on if your vehicle is creating a safety hazard for other road users.

When you switch the hazard flashers on, all front and rear direction indicators flash.

Note: *The hazard flashers operate when the ignition is in any position, or if the key is not in the ignition. The battery loses charge and could have insufficient power to restart your vehicle.*

Press the button again to switch them off.

JUMP STARTING THE VEHICLE

JUMP STARTING PRECAUTIONS



WARNING: Batteries normally produce explosive gases which can cause personal injury. Therefore, do not allow flames, sparks or lighted substances to come near the battery. When working near the battery, always shield your face and protect your eyes. Always provide correct ventilation.



WARNING: Keep batteries out of reach of children. Batteries contain sulfuric acid. Avoid contact with skin, eyes or clothing. Shield your eyes when working near the battery to protect against possible splashing of acid solution. In case of acid contact with skin or eyes, flush immediately with water for a minimum of 15 minutes and get prompt medical attention. If acid is swallowed, call a physician immediately.



WARNING: Use only adequately sized cables with insulated clamps.



WARNING: Make sure that the cables are clear of any moving parts and fuel delivery system parts.



WARNING: Connect batteries with only the same nominal voltage.



WARNING: If the engine is running while the hood is open, stay clear of moving engine components. Failure to follow this warning could result in serious personal injury or death.

Do not attempt to push-start an automatic transmission vehicle. This could cause transmission damage.

Do not disconnect the battery of the disabled vehicle. This could damage your vehicle's electrical system.

PREPARING THE VEHICLE

Use only a 12 volt supply to start your vehicle.

Park the booster vehicle close to the hood of the disabled vehicle, making sure the two vehicles do not touch.

Crash and Breakdown Information

JUMP STARTING THE VEHICLE

Connecting the Jumper Cables



WARNING: Do not connect the negative jumper cable to any other part of your vehicle. Use the ground point.

Note: If you are using a jump pack or booster box, follow the manufacturer's instructions.

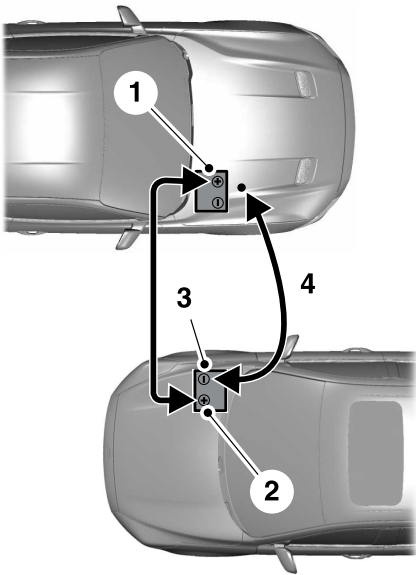

1. Pull the red rubber boot backward. Connect the positive (+) jumper cable to the positive (+) terminal of the discharged battery.
2. Connect the other end of the positive (+) jumper cable to the positive (+) terminal of the booster vehicle battery.

3. Connect the negative (-) jumper cable to the negative (-) terminal of the booster vehicle battery.
4. Make the final connection of the negative (-) jumper cable to an exposed metal part of the disabled vehicle's engine, as shown in the following illustration, away from the battery and fuel injection system, or connect the negative (-) jumper cable to a ground connection point if available.

Note: Do not use the hood latch as a negative (-) connection point. This could cause springs in the latch to burn and prevent the hood from operating correctly.

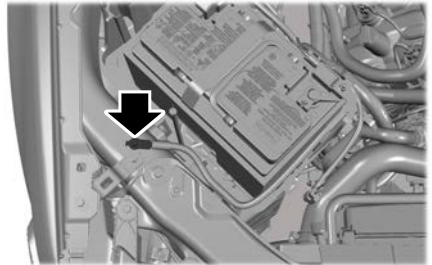

Starting the Engine

1. Start the engine of the booster vehicle and moderately rev the engine, or gently press the accelerator to keep the engine speed between 2000 and 3000 RPM, as shown in your tachometer.
2. Start the engine of the disabled vehicle.
3. Once you start the disabled vehicle, run both vehicle engines for an additional three minutes before disconnecting the jumper cables.

Crash and Breakdown Information

Removing the Jumper Cables

Remove the jumper cables in the reverse order that they were connected.

Note: *Do not switch the headlamps on when disconnecting the cables. The peak voltage could blow the bulbs.*

POST-CRASH ALERT SYSTEM

WHAT IS THE POST-CRASH ALERT SYSTEM

The system helps draw attention to your vehicle in the event of a serious impact.

HOW DOES THE POST-CRASH ALERT SYSTEM WORK

The system is designed to turn the hazard flashers on and to intermittently sound the horn in the event of a serious impact that deploys an airbag or the seatbelt pretensioners.

POST-CRASH ALERT SYSTEM LIMITATIONS

Depending on applicable laws in the country your vehicle was built for, the horn does not sound in the event of a serious impact.

SWITCHING THE POST-CRASH ALERT SYSTEM OFF

Press the hazard flasher switch or the unlock button on the remote control to switch the system off.

Note: *The alert turns off when the vehicle battery runs out of charge.*

AUTOMATIC CRASH SHUTOFF

WHAT IS AUTOMATIC CRASH SHUTOFF

The automatic crash shutoff is designed to stop the fuel going to the engine in the event of a moderate or severe crash.

Note: *Not every impact causes a shutoff.*

AUTOMATIC CRASH SHUTOFF PRECAUTIONS



WARNING: If your vehicle has been involved in a crash, have the fuel system checked. Failure to follow this instruction could result in fire, personal injury or death.

RE-ENABLING YOUR VEHICLE

1. Switch the ignition off.
2. Attempt to start your vehicle.
3. Switch the ignition off.
4. Attempt to start your vehicle.

Note: *If your vehicle does not start after the third attempt, have your vehicle checked as soon as possible.*

Crash and Breakdown Information

RECOVERY TOWING

ACCESSING THE FRONT TOWING POINT



WARNING: Using recovery hooks is dangerous and should only be done by a person familiar with proper vehicle recovery safety practices. Improper use of recovery hooks may cause hook failure or separation from the vehicle and could result in serious injury or death.



WARNING: Slowly remove the slack from the recovery strap prior to pulling. Failure to do so can introduce significantly higher loads which can cause the recovery hooks to break off, or the recovery strap to fail which can cause serious injury or death.



WARNING: Never link two straps together with a clevis pin. These heavy metal objects could become projectiles if the strap breaks and can cause serious injury or death.



WARNING: Switch the ignition off before removing the recovery hook. Failure to do so could result in personal injury.



WARNING: The recovery hook can become hot. Let the recovery hook cool down before removing it. Failure to do so could result in personal injury.

Your vehicle has frame-mounted front recovery hooks.

Note: Do not apply a load to the recovery hooks that is greater than the gross vehicle weight rating of your vehicle.

Before using recovery hooks:

- Make sure all attaching points are secure and capable of withstanding the applied load.
- Do not use chains, cables or tow straps with metal hook ends.
- Only use recovery straps that have a minimum breaking strength two to three times the gross vehicle weight of the stuck vehicle.
- Make sure the recovery strap is in good condition and free of visible cuts, tears or damage.
- Use a damper device such as a tarp, heavy blanket or piece of carpet, and place it over the recovery strap to help absorb the energy in the event the strap breaks.
- Make sure the stuck vehicle is not loaded heavier than its gross vehicle weight rating specified on the certification label.
- Align the tow vehicle and stuck vehicle in a straight line, within 10 degrees.
- Keep bystanders to the sides of the vehicle, at a distance of at least twice the length of the recovery strap. This helps avoid injury from the hazard of a recovery hook or strap breaking, or a vehicle lurching into their path.

Crash and Breakdown Information

TRANSPORTING THE VEHICLE

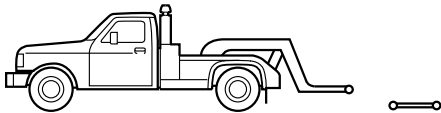

All-wheel or four-wheel drive vehicles require that all wheels be off the ground using a wheel lift and dollies or flatbed equipment. This prevents damage to the transmission and drive system.

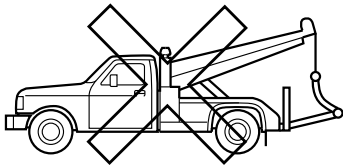
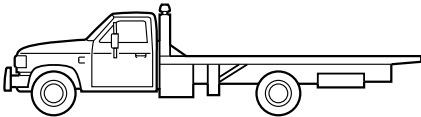

If you need to tow your vehicle, contact a professional towing service or your roadside assistance service provider.

Your manufacturer produces a towing manual for all authorized tow truck operators. Have your tow truck operator refer to this manual for proper hook-up and towing procedures.

We recommend the use of a wheel lift and dollies or flatbed equipment to tow your vehicle. Vehicle damage could occur if towed incorrectly, or by any other means.

Front-wheel and rear-wheel drive vehicles must have their designated drive wheels off the ground regardless of towing direction. Use tow dollies to prevent damage to the transmission.

Towing Your Vehicle

TOWING YOUR VEHICLE PRECAUTIONS

Use the following guidelines when towing your vehicle. Failure to follow this instruction could result in vehicle damage not covered by the vehicle warranty.

Note: Make sure you properly secure your vehicle to the tow vehicle.

Note: If you are unsure of the vehicle's configuration, contact an authorized dealer.

RECREATIONALLY TOWING YOUR VEHICLE - 4X4



WARNING: Do not disconnect the battery when recreationally towing your vehicle. This prevents the transfer case from shifting properly and could cause the vehicle to roll, even if the transmission is in park (P).



WARNING: Placing the transfer case in its neutral position could cause your vehicle to freely roll. Make sure you press and hold the brake pedal and the vehicle is in a secure, safe position when you place the transfer case in its neutral position.

Follow these guidelines if you have a need for recreational towing. An example of recreational towing would be towing your vehicle behind a motorhome. These guidelines are to make sure that you do not damage the transmission.

You can only tow your vehicle with all wheels on the ground by placing the transfer case in its neutral position and engaging the recreational tow feature. Perform the following steps after positioning your vehicle behind the tow vehicle and properly securing them together.

Note: Put your climate control system in recirculated air mode to prevent exhaust fumes from entering your vehicle.

Note: Failure to put the transfer case in its neutral position can damage vehicle components.

Note: You can check the towing status at any time by opening the driver door or turning the ignition to the accessory or on position. **Neutral Tow Enabled Leave Transmission in Neutral** appears in the instrument cluster display to confirm you can recreationally tow your vehicle.

Note: If your vehicle has an anti-theft alarm, make sure you switch perimeter sensing on when towing. See **Setting the Alarm Security Level** (page 133).

Switching Neutral Tow On

1. Start your vehicle.
2. Press the **2H** button on the four-wheel drive mode control.
3. Place your vehicle in temporary neutral mode. See **Entering Temporary Neutral Mode** (page 264).
4. Switch your vehicle off by pressing the push button ignition switch once or turning the key as far toward the off position as possible. A message appears in the instrument cluster display.
5. Switch your vehicle to accessory mode by pressing the push button ignition switch once without pressing the brake pedal or by turning the key to the on position.

Towing Your Vehicle

6. Press and hold the brake pedal.
7. Using the instrument cluster controls on the steering wheel, select **Settings**.
8. Select **Neutral Tow**.
9. Press and hold the **OK** button until a confirmation message appears in the information display.

Note: If completed successfully, the information display shows **Neutral Tow Enabled Leave Transmission in Neutral**. This indicates that your vehicle is safe to tow with all wheels on the ground.

Note: If you do not see a confirmation message in the instrument cluster display, you must perform the procedure again from the beginning.

Note: You may hear noise as the transfer case shifts into its neutral position. This is normal.

10. Release the brake pedal.
11. Leave the transmission in neutral (N) and switch your vehicle off by pressing the push button ignition switch once without pressing the brake pedal or turning the key as far toward the off position.

Note: Vehicles with keys do not turn to the off position when the transmission is in neutral (N). You must leave the key in the ignition when towing. Use the keyless entry keypad or an extra set of keys to lock and unlock your vehicle.

Switching Neutral Tow Off

1. With your vehicle properly secured to the tow vehicle, press and hold the brake pedal and start the engine.
2. Switch your vehicle off by pressing the push button ignition switch once or turning the key as far towards the off position and release the brake pedal.

3. Place your vehicle in accessory mode by pressing the push button ignition switch once without pressing the brake pedal or by turning the ignition key to the on position.
4. Press and hold the brake pedal.
5. Shift into park (P).
6. Release the brake pedal.

Note: If completed successfully, the instrument cluster displays **2H** and **Neutral Tow Disabled**.

Note: You must perform the switching neutral tow on and switching neutral tow off procedures again from the beginning if the indicator light and message do not display.

Note: You may hear a noise as the transfer case shifts out of its neutral position. This is normal.

7. Apply the parking brake, then disconnect your vehicle from the tow vehicle.
8. Release the parking brake, start the engine, and shift into drive (D) to make sure the transfer case is out of the neutral tow position.
9. If the transfer case does not successfully shift out of its neutral position, set the parking brake. Have your vehicle checked as soon as possible.

Resolving the Shift Delayed Drive Forward Message

1. Press and hold the brake pedal.
2. Start your vehicle.
3. Shift into neutral (N).
4. With the vehicle running, shift into drive (D) and let the vehicle roll forward up to 3 ft (1 m).

Towing Your Vehicle

Note: You may hear a noise as the transfer case shifts out of its neutral position. This is normal.

5. Make sure the instrument cluster displays **Neutral Tow Disabled**.

RECREATIONALLY TOWING YOUR VEHICLE - 4X2

You cannot recreational tow your vehicle with all wheels on the ground because vehicle or transmission damage could occur. You must recreational tow your vehicle with all four wheels off the ground, such as when using a car-hauling trailer. Otherwise, you cannot recreational tow your vehicle.

EMERGENCY TOWING

If your vehicle becomes inoperable without access to wheel dollies or a vehicle transport trailer, it can be flat-towed with all wheels on the ground, regardless of the powertrain and transmission configuration, under the following conditions:

- Your vehicle is facing forward for towing in a forward direction.
- Use the manual park release procedure. See **Using Manual Park Release** (page 267). Failure to do so may result in damage to the transmission.
- Maximum speed is 35 mph (56 km/h).
- Maximum distance is 50 mi (80 km).

TOWING YOUR VEHICLE – TROUBLESHOOTING

TOWING YOUR VEHICLE – INFORMATION MESSAGES

| Message | Description |
|--|---|
| Neutral Tow Enabled Leave Transmission in Neutral | The transfer case is in the neutral position and your vehicle is safe to tow with all four wheels on the ground. |
| Shift Delayed Drive Forward | There is a transfer case gear tooth blockage present. With your vehicle on, shift the transmission into drive (D) and let the vehicle roll forward, up to 3 ft (1 m). |
| Neutral Tow Disabled | The transfer case is not in the neutral position and your vehicle is not safe to tow with all four wheels on the ground. |

Fuses

FUSE PRECAUTIONS



WARNING: Always disconnect the battery before servicing high current fuses.



WARNING: To reduce risk of electrical shock, always replace the cover to the power distribution box before reconnecting the battery or refilling fluid reservoirs.



WARNING: Always replace a fuse with one that has the specified amperage rating. Using a fuse with a higher amperage rating can cause severe wire damage and could start a fire.

UNDER HOOD FUSE BOX

LOCATING THE UNDER HOOD FUSE BOX

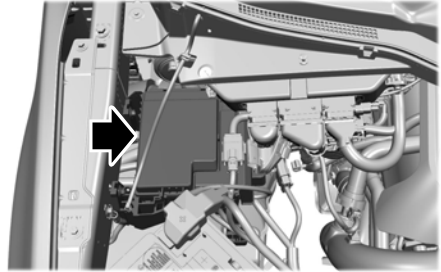

ACCESSING THE UNDER HOOD FUSE BOX

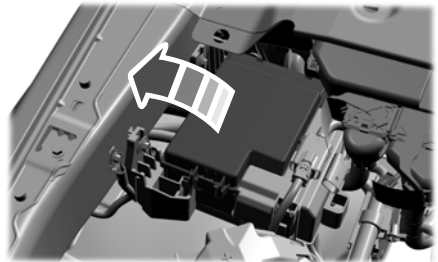

Fuses

IDENTIFYING THE FUSES IN THE UNDER HOOD FUSE BOX

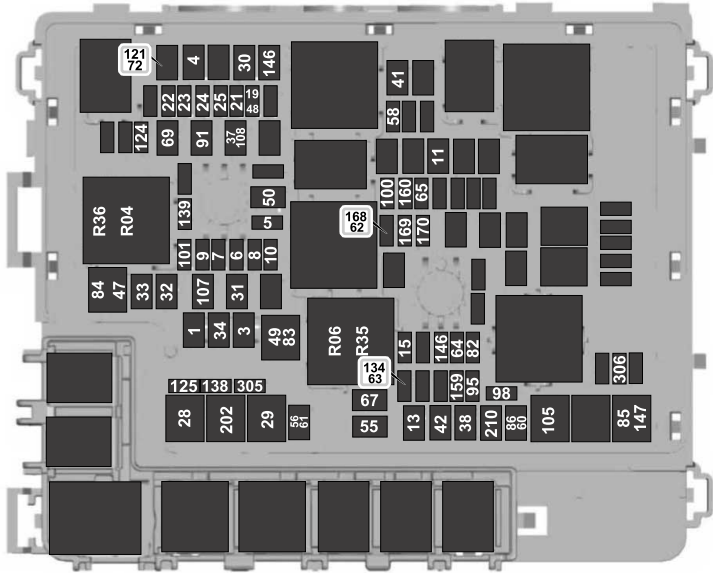

| Item | Rating | Protected Component |
|------|--------|--|
| 1 | 40 A | Body control module - battery power in feed 1. |
| 3 | 40 A | Body control module - battery power in feed 2. |
| 4 | 30 A | Fuel pump. |
| 5 | 5 A | Powertrain control module coil. |
| 6 | 25 A | Powertrain control module power (gas, hybrid). |
| 7 | 20 A | Powertrain control module power. |

Fuses

| Item | Rating | Protected Component |
|-------------|---------------|--|
| 8 | 20 A | Powertrain control module power (hybrid). |
| | 10 A | Powertrain control module power (gas, Raptor, Tremor). |
| 9 | 20 A | Powertrain control module power (gas, hybrid). |
| 10 | — | Not used. |
| 11 | 30 A | Starter motor. |
| 13 | 40 A | Blower motor. |
| 15 | 25 A | Horn. |
| 19 | 20 A | Snowplow switch (gas). Rear heated seats (gas, hybrid). |
| 21 | 10 A | Headlamp run/start feed. |
| 22 | 10 A | Electronic power assist steering. |
| 23 | 10 A | Electric brake boost. |
| 24 | 10 A | Powertrain control module (gas, hybrid). |
| 25 | 10 A | Center high-mounted stop lamp camera. Trailer camera. 2 kW inverter. 24 V alternator - run/start feed. Analog rear video camera. |
| 28 | 50 A | Electric brake boost. |
| 29 | 50 A | Electric brake boost. |
| 30 | 40 A | Driver power seat. |
| 31 | 30 A | Passenger power seat. |
| 32 | 20 A | Auxiliary power point. |
| 33 | 20 A | Auxiliary power point. |

Fuses

| Item | Rating | Protected Component |
|------|--------|--|
| | | USB smart charger. |
| 34 | 20 A | Auxiliary power point. |
| 37 | 30 A | Tailgate module. |
| 38 | 40 A | Climate controlled seat module. Power running boards. |
| 41 | 25 A | Power sliding back window. |
| 42 | 30 A | Trailer brake control module. |
| 47 | 50 A | Cooling fan (gas, hybrid, Raptor, Tremor). |
| 48 | 20 A | Rear heated seats (Raptor, Tremor) |
| 49 | 50 A | Cooling fan (gas, hybrid, Raptor, Tremor). |
| 50 | 40 A | Heated backlight (gas, hybrid). |
| 55 | 30 A | Trailer tow park lamps. |
| 56 | 20 A | Trailer tow stop and turn lamps (4-pin connector). |
| 58 | 10 A | Trailer tow backup lamps. |
| 60 | 15 A | Upfitter 1 relay (Raptor, Tremor). |
| 61 | 15 A | Upfitter 2 relay (Raptor, Tremor). |
| 62 | 10 A | Upfitter 3 relay (Raptor, Tremor). |
| 63 | 10 A | Upfitter 4 relay (Raptor, Tremor). |
| 64 | 25 A | Four-wheel drive. |
| 65 | — | Not used. |
| 67 | 20 A | Transmission run/start. |

Fuses

| Item | Rating | Protected Component |
|------|--------|--|
| 69 | 30 A | Left-hand windshield wiper. |
| 72 | 30 A | Not used (spare). |
| 82 | 25 A | Four-wheel drive. |
| 83 | — | Not used. |
| 84 | — | Not used. |
| 85 | — | Not used. |
| 86 | — | Not used. |
| 91 | 20 A | Trailer tow light module. |
| 95 | 15 A | Powertrain control module power (hybrid). |
| 98 | 10 A | Powertrain control module power (hybrid). Coolant pumps (hybrid). |
| 100 | 15 A | Left-hand headlamps. |
| 101 | 15 A | Right-hand headlamps. |
| 105 | 50 A | Active front steering. |
| 107 | 30 A | Trailer tow battery charge. |
| 108 | 15 A | Spot lamps (police). |
| 121 | — | Not used. |
| 124 | 5 A | Rain sensor module. |
| 125 | 10 A | USB smart charger. |
| 134 | 25 A | Multi-contour seats relay (gas, hybrid). |
| 138 | 10 A | Tailgate release. |
| 139 | 5 A | USB smart charger. |
| 146 | 15 A | Traction battery control module (hybrid). |
| 147 | 40 A | Change air cooler fan relay (Raptor, Tremor). |

Fuses

| Item | Rating | Protected Component |
|-------------|---------------|--|
| 159 | 5 A | DC/DC power (hybrid). |
| 160 | 10 A | Smart data link control. |
| 168 | 15 A | Traction battery control module (hybrid). |
| 169 | 10 A | Motor electric cool pump (hybrid). |
| 170 | 10 A | Pedestrian alert control module (hybrid). Traction battery control module (hybrid). Electric motor cool pump (hybrid). |
| 202 | 60 A | Body control module B+. |
| 210 | 30 A | Body control module start/stop. |
| 305 | 5 A | Upfitter 5 relay (Raptor, Tremor). |
| 306 | 5 A | Upfitter 6 relay (Raptor, Tremor). |

| Relay Number | Protected Component |
|---------------------|----------------------------|
| R04 | Electronic fan relay 1. |
| R06 | Electronic fan relay 3. |
| R35 | Not used. |
| R36 | Not used. |

Fuses

BODY CONTROL MODULE FUSE BOX

ACCESSING THE BODY CONTROL MODULE FUSE BOX

LOCATING THE BODY CONTROL MODULE FUSE BOX

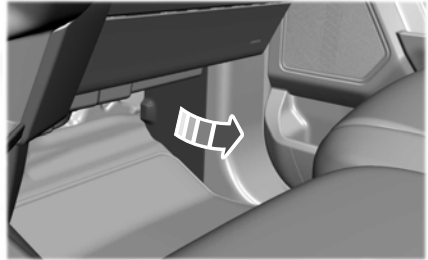
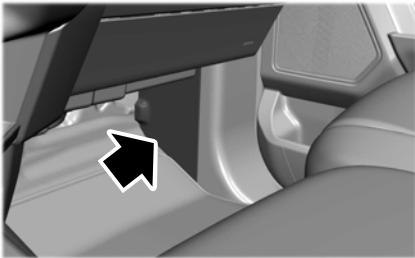

IDENTIFYING THE FUSES IN THE BODY CONTROL MODULE FUSE BOX

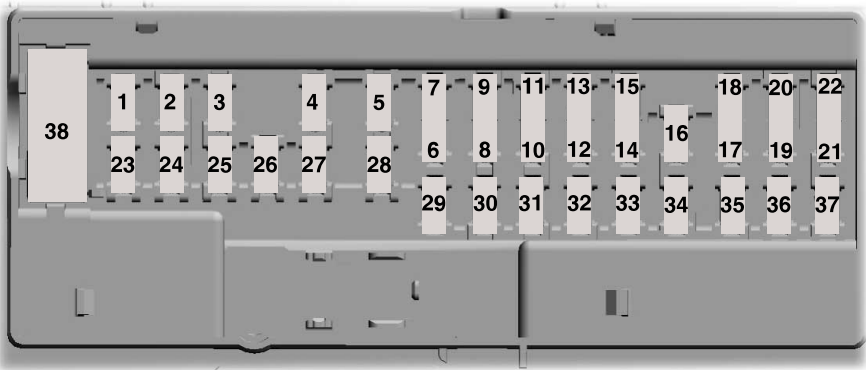

Fuses

| Fuse Location | Fuse Rating | Protected Component |
|----------------------|--------------------|---|
| 1 | — | Not used. |
| 2 | 10 A | Delayed accessory feed. |
| 3 | 7.5 A | Wireless charger. |
| 4 | 20 A | Not used. |
| 5 | — | Not used. |
| 6 | 10 A | Driver power window switch. |
| 7 | 10 A | Gear shift module. |
| 8 | 5 A | Cell phone passport module. |
| 9 | 5 A | Combined sensor module. |
| 10 | — | Not used. |
| 11 | — | Not used. |
| 12 | 7.5 A | Enhanced central gateway. Climate control. |
| 13 | 7.5 A | Instrument cluster. Steering column control module. |
| 14 | 15 A | Not used (spare). |
| 15 | 15 A | Integrated control panel. SYNC. |
| 16 | — | Not used. |
| 17 | 7.5 A | Headlamp control module. |
| 18 | 7.5 A | Not used. |
| 19 | 5 A | Headlamp switch. |
| 20 | 5 A | Passive start. Ignition switch. Key inhibit solenoid. |
| 21 | 5 A | Trailer brake switch. |
| 22 | 5 A | Not used. |

Fuses

| Fuse Location | Fuse Rating | Protected Component |
|----------------------|-----------------------|--|
| 23 | 30 A | Driver door control module. |
| 24 | 30 A | Moonroof. |
| 25 | 20 A | Not used. |
| 26 | 30 A | Passenger door control module. |
| 27 | 30 A | Not used. |
| 28 | 30 A | Amplifier. |
| 29 | 15 A | 12 inch display. Adjustable pedals. |
| 30 | 5 A | Not used. |
| 31 | 10 A | RF receiver. Driver monitor. Terrain management switch. |
| 32 | 20 A | Audio control module. |
| 33 | — | Not used. |
| 34 | 30 A | Run/start relay. |
| 35 | 5 A | 400 watt inverter run/start. |
| 36 | 15 A | Auto-dimming interior mirror. Rear heat seat run/start. Adaptive front steering run/start. Heated wheel (vehicles without adaptive front steering). |
| 37 | 20 A | Advanced driver-assistance systems. |
| 38 | 30 A circuit breaker. | Rear power windows. |

Fuses

IDENTIFYING FUSE TYPES

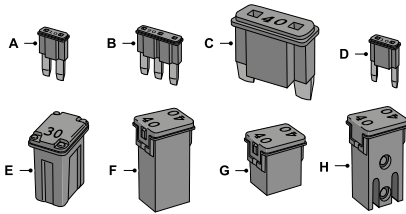

- A Micro 2.
- B Micro 3.
- C Maxi.
- D Mini.
- E M Case.
- F J Case.
- G J Case Low Profile.
- H Slotted M Case.

FUSES – TROUBLESHOOTING

FUSES – FREQUENTLY ASKED QUESTIONS

When do I need to check a fuse?

If electrical components in the vehicle are not working.

When do I need to replace a fuse?

If a fuse has blown.

How do I identify a blown fuse?

You can identify a blown fuse by a broken wire within the fuse.

Maintenance

MAINTENANCE PRECAUTIONS

Service your vehicle regularly to help maintain its roadworthiness and resale value. There is a large network of authorized dealers that are there to help you with their professional servicing expertise. We believe that their specially trained technicians are best qualified to service your vehicle properly and expertly. They are supported by a wide range of highly specialized tools developed specifically for servicing your vehicle.

If your vehicle requires professional service, an authorized dealer can provide the necessary parts and service. Check your warranty information to find out which parts and services are covered.

Use only recommended fuels, lubricants, fluids and service parts conforming to specifications. See **Capacities and Specifications** (page 558).

- Do not work on a hot engine.
- Make sure that nothing gets caught in moving parts.
- Do not work on a vehicle with the engine running in an enclosed space, unless you are sure you have enough ventilation.
- Keep all open flames and other burning material, such as cigarettes, away from the battery and all fuel related parts.
- Set the parking brake, shift the transmission to park (P) and block the wheels.

OPENING AND CLOSING THE HOOD

 **WARNING:** Make sure that you fully latch the hood before driving. Failure to follow this instruction could result in personal injury or death.



1. Pull the hood release handle under the left hand side of the instrument panel.

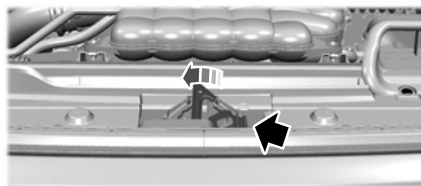

2. Pull the secondary release lever under the front of the hood near the center of your vehicle.

Maintenance

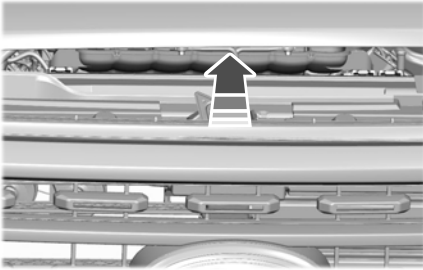

3. Raise the hood until the lift cylinders hold it open.
4. To close, lower the hood and make sure that it fully latches.

UNDER HOOD OVERVIEW - 2.7L ECOBOOST™

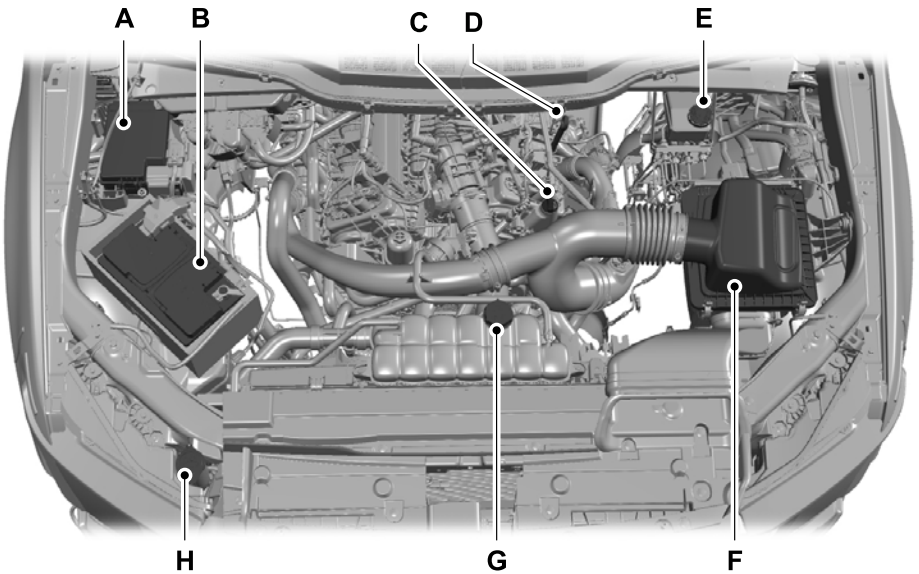

- A. Engine compartment fuse box. See **Fuses** (page 472).
- B. Battery. See **Changing the 12V Battery** (page 494).
- C. Engine oil filler cap. See **Checking the Engine Oil Level** (page 488).

Maintenance

- D. Engine oil dipstick. See **Engine Oil Dipstick Overview** (page 488).
- E. Brake fluid reservoir. See **Checking the Brake Fluid** (page 287).
- F. Air filter assembly. See **Changing the Engine Air Filter** (page 493).
- G. Engine coolant reservoir. See **Checking the Coolant** (page 489).
- H. Windshield washer fluid reservoir.

UNDER HOOD OVERVIEW - 3.3L

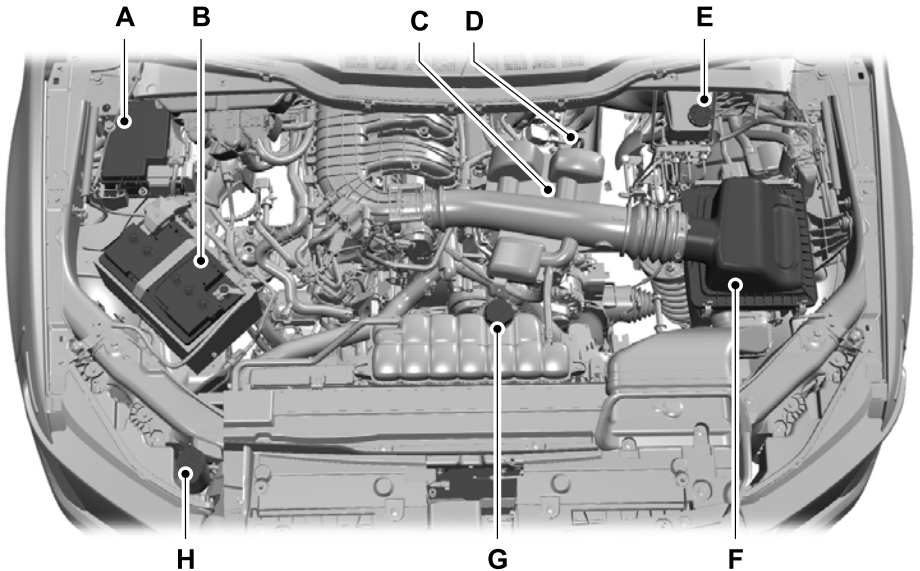

- A. Engine compartment fuse box. See **Fuses** (page 472).
- B. Battery. See **Changing the 12V Battery** (page 494).
- C. Engine oil filler cap. See **Checking the Engine Oil Level** (page 488).
- D. Engine oil dipstick. See **Engine Oil Dipstick Overview** (page 488).
- E. Brake fluid reservoir. See **Checking the Brake Fluid** (page 287).
- F. Air filter assembly. See **Changing the Engine Air Filter** (page 493).

Maintenance

- G. Engine coolant reservoir. See **Checking the Coolant** (page 489).
- H. Windshield washer fluid reservoir.

UNDER HOOD OVERVIEW - 3.5L ECOBOOST™

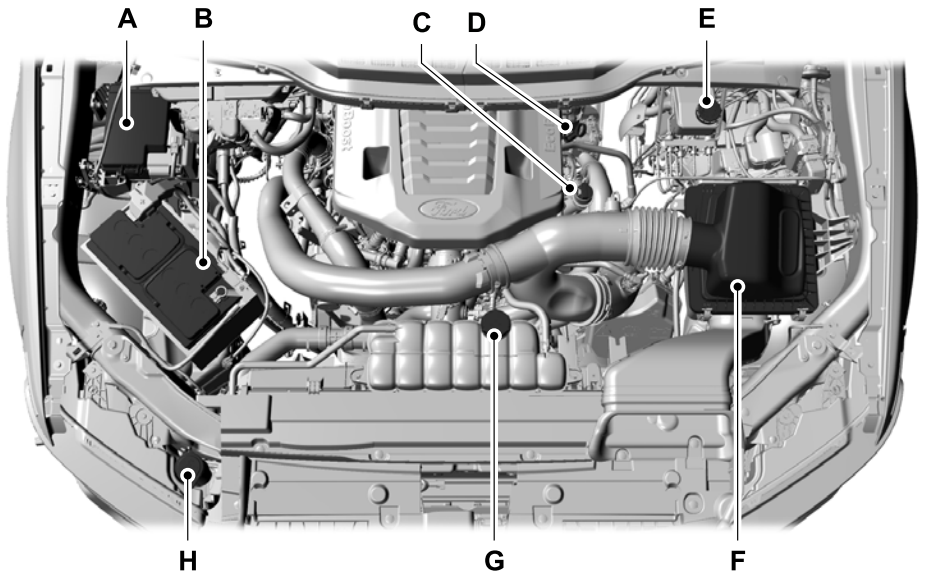

- A. Engine compartment fuse box. See **Fuses** (page 472).
- B. Battery. See **Changing the 12V Battery** (page 494).
- C. Engine oil filler cap. See **Checking the Engine Oil Level** (page 488).
- D. Engine oil dipstick. See **Engine Oil Dipstick Overview** (page 488).
- E. Brake fluid reservoir. See **Brakes** (page 286).
- F. Air filter. See **Changing the Engine Air Filter** (page 493).
- G. Engine coolant reservoir. See **Checking the Coolant** (page 489).
- H. Windshield washer fluid reservoir.

Maintenance

UNDER HOOD OVERVIEW - 3.5L, HYBRID ELECTRIC VEHICLE (HEV)

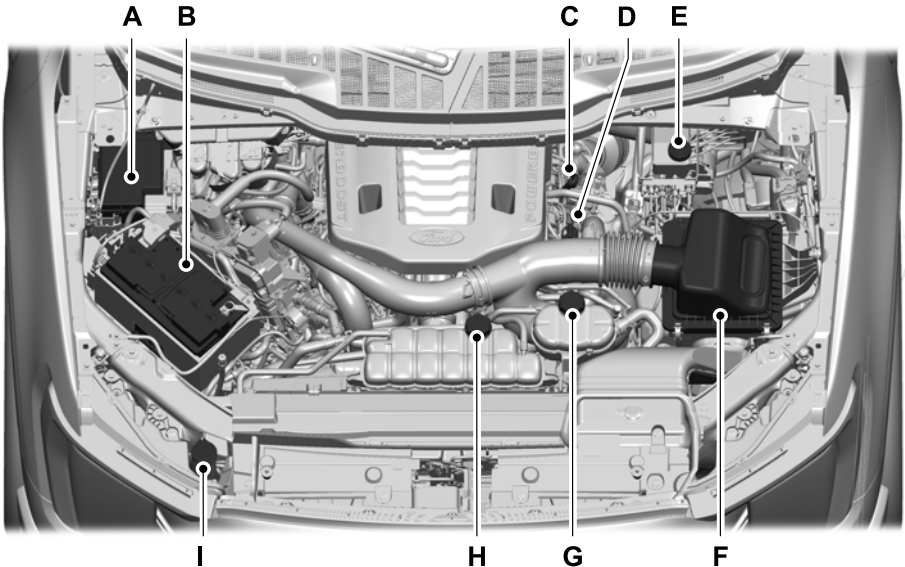

- A. Engine compartment fuse box. See **Fuses** (page 472).
- B. Battery. See **Changing the 12V Battery** (page 494).
- C. Engine oil dipstick. See **Engine Oil Dipstick Overview** (page 488).
- D. Engine oil filler cap. See **Adding Engine Oil** (page 488).
- E. Brake fluid reservoir. See **Checking the Brake Fluid** (page 287).
- F. Air filter. See **Changing the Engine Air Filter** (page 493).
- G. Secondary coolant reservoir. See **Checking the Coolant** (page 489).
- H. Engine coolant reservoir. See **Checking the Coolant** (page 489).
- I. Windshield washer fluid reservoir.

Maintenance

UNDER HOOD OVERVIEW - 5.0L

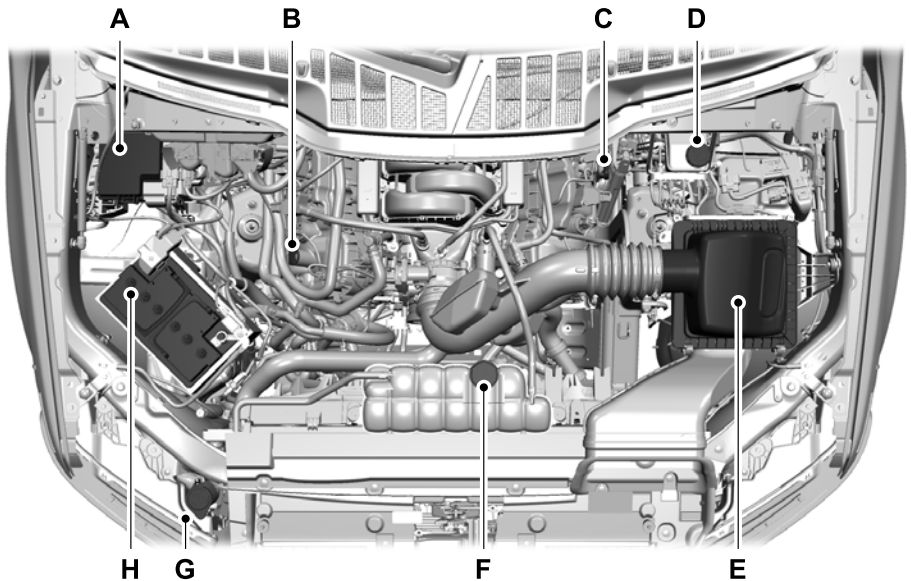

- A. Engine compartment fuse box. See **Under Hood Fuse Box** (page 472).
- B. Engine oil filler cap. See **Engine Oil Dipstick Overview** (page 488).
- C. Engine oil dipstick. See **Engine Oil Dipstick Overview** (page 488).
- D. Brake fluid reservoir. See **Checking the Brake Fluid** (page 287).
- E. Air filter assembly. See **Changing the Engine Air Filter** (page 493).
- F. Engine coolant reservoir. See **Checking the Coolant** (page 489).
- G. Windshield washer fluid reservoir.
- H. Battery. See **Changing the 12V Battery** (page 494).

Maintenance

ENGINE OIL

ENGINE OIL DIPSTICK OVERVIEW - GASOLINE, HYBRID ELECTRIC VEHICLE (HEV)

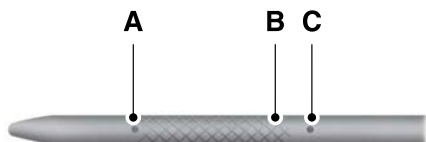

- A Minimum.
- B Nominal.
- C Maximum.

CHECKING THE ENGINE OIL LEVEL

1. Make sure that your vehicle is on level ground.
2. Check the oil level before starting the engine, or switch the engine off after warming up and wait 10 minutes for the oil to drain into the oil pan.
3. Remove the dipstick and wipe it with a clean, lint-free cloth.
4. Reinstall the dipstick and make sure it is fully seated.
5. Remove the dipstick again to check the oil level.

Note: *If the oil level is between the maximum and minimum marks, the oil level is acceptable. Do not add oil.*

6. If the oil level is at the minimum mark, immediately add oil.

7. Reinstall the dipstick. Make sure it is fully seated.

Note: *The oil consumption of new engines reaches its normal level after approximately 3,000 mi (5,000 km).*

ADDING ENGINE OIL



WARNING: Do not remove the filler cap when the engine is running.



WARNING: Do not add engine oil when the engine is hot. Failure to follow this instruction could result in personal injury.

Do not use supplemental engine oil additives because they are unnecessary and could lead to engine damage that the vehicle warranty may not cover.

1. Clean the area surrounding the engine oil filler cap before you remove it.
2. Remove the engine oil filler cap.
3. Add engine oil that meets our specifications. See **Capacities and Specifications** (page 558).
4. Reinstall the engine oil filler cap. Turn it clockwise until you feel a strong resistance.

Note: *Do not add oil further than the maximum mark. Oil levels above the maximum mark may cause engine damage.*

Note: *Immediately soak up any oil spillage with an absorbent cloth.*

RESETTING THE ENGINE OIL CHANGE REMINDER - VEHICLES WITH: 4.2 INCH SCREEN

1. Press the Menu button on the steering wheel to enter the information display main menu.
2. Select **Truck Info**.

Maintenance

3. Select **Oil Life**.
4. Select **Reset Oil Life**.
5. Press and hold the **OK** button until the system reset confirmation appears.

RESETTING THE ENGINE OIL CHANGE REMINDER - VEHICLES WITH: 8 INCH SCREEN/12.3 INCH SCREEN

Depending on your cluster, there are two paths to reset the engine oil change reminder.

Path 1

1. Press the Menu button on the steering wheel to enter the information display main menu.
2. Select **Settings**.
3. Select **Vehicle Maintenance**.
4. Select **Oil Life**.
5. Press and hold the **OK** button until the system reset confirmation appears.

Path 2

1. Press the Menu button on the steering wheel to enter the information display main menu.
2. Select **Truck Info**.
3. Select **Engine Information**.
4. Press and hold the **OK** button until the system reset confirmation appears.

ENGINE OIL CAPACITY AND SPECIFICATION

For filling information, please refer to the Capacities and Specifications section of your owner's manual. See **Engine Oil Capacity and Specification** (page 489).

CHECKING THE COOLANT

When the engine is cold, check the concentration and level of the coolant at the intervals listed in the scheduled maintenance information. See **Scheduled Maintenance** (page 642).

Note: Make sure that the coolant level is between the minimum and maximum marks on the coolant reservoir.

Note: Coolant expands when it is hot. The level may extend beyond the **MAX** mark.

If the coolant level is at or below the minimum mark, add prediluted coolant immediately.

Maintain coolant concentration within 48% to 50%, which equates to a freeze point between -29°F (-34°C) and -35°F (-37°C). Coolant concentration should be checked using a refractometer. We do not recommend the use of hydrometers or coolant test strips for measuring coolant concentration.

Adding Coolant



WARNING: Keep your hands and clothing clear of the cooling fan.



WARNING: Do not remove the coolant reservoir cap when the engine is on or the cooling system is hot. Wait 10 minutes for the cooling system to cool down. Cover the coolant reservoir cap with a thick cloth to prevent the possibility of scalding and slowly remove the cap. Failure to follow this instruction could result in personal injury.



WARNING: Do not add engine coolant when the engine is on or the cooling system is hot. Failure to follow this instruction could result in personal injury.

Maintenance

 **WARNING:** Do not add coolant further than the **MAX** mark.

 **WARNING:** Do not put coolant in the windshield washer reservoir. If sprayed on the windshield, coolant could make it difficult to see through the windshield.

 **WARNING:** Do not allow the fluid to touch your skin or eyes. If this happens, rinse the affected areas immediately with plenty of water and contact your physician.

Note: Do not use stop leak pellets, cooling system sealants, or non-specified additives as they can cause damage to the engine cooling or heating systems. Resulting component damage may not be covered by the vehicle Warranty.

Note: Automotive fluids are not interchangeable.

It is very important to use prediluted coolant approved to the correct specification in order to avoid plugging the small passageways in the engine cooling system. See **Capacities and Specifications** (page 558). Do not mix different colors or types of coolant in your vehicle. Mixing of engine coolants or using an incorrect coolant may harm the engine or cooling system components and could void the vehicle Warranty.

Note: If prediluted coolant is not available, use the approved concentrated coolant diluting it to 50/50 with deionized or distilled water. See **Capacities and Specifications** (page 558). Using water that has not been deionized may contribute to deposit formation, corrosion and plugging of the small cooling system passageways.

To top up the coolant level do the following:

1. Unscrew the cap slowly. Any pressure escapes as you unscrew the cap.
2. Add enough prediluted coolant to reach the correct level.

Note: We do not recommend the use of recycled coolant.

3. Replace the coolant reservoir cap. Turn the cap clockwise until it contacts the hard stop.
4. Check the coolant level in the coolant reservoir the next few times you drive your vehicle. If necessary, repeat step 2.

If you have to add more than 1.1 qt (1 L) of engine coolant per month, have your vehicle checked as soon as possible. Operating an engine with a low level of coolant can result in engine overheating and possible engine damage.

In case of emergency, you can add a large amount of water without engine coolant in order to reach a vehicle service location. Service your vehicle as soon as possible.

Water alone, without engine coolant, can cause engine damage from corrosion, overheating or freezing.

Do not use the following as a coolant substitute, as they can cause engine damage from overheating or freezing:

- Alcohol.
- Methanol.
- Brine.
- Any coolant mixed with alcohol or methanol antifreeze.

Do not add extra inhibitors or additives to the coolant. These can be harmful and compromise the corrosion protection of the coolant.

Maintenance

Severe Climates

If you drive in extremely cold climates, you may need to increase the coolant concentration above 50%.

Note: A coolant concentration of 60% provides improved freeze point protection. Coolant concentrations above 60% decrease the overheat protection characteristics of the coolant and could cause engine damage.

If you drive in extremely hot climates, you may need to decrease the coolant concentration to 40%.

Note: A coolant concentration of 40% provides improved overheat protection. Coolant concentrations below 40% decrease the overheat and corrosion protection characteristics of the coolant and could cause engine damage.

Coolant Change



WARNING: Do not dispose of coolant in the household refuse or the public sewage system. Use an authorized waste disposal facility.

Change the coolant at specific mileage intervals. Refer to the scheduled maintenance information. See **Normal Scheduled Maintenance** (page 645).

Note: Dispose of used coolant in the appropriate manner.

Follow your community's regulations and standards for recycling and disposing of automotive fluids.

Fail-Safe Cooling

Fail-safe cooling allows you to temporarily drive your vehicle before any incremental component damage occurs. The fail-safe distance depends on ambient temperature, vehicle load and terrain.

How Fail-Safe Cooling Works



If the engine begins to overheat, the coolant temperature gauge moves toward the red zone:



A warning lamp illuminates and a message may appear in the information display.

If the engine reaches a preset over-temperature condition, the engine automatically switches to alternating cylinder operation. Each disabled cylinder acts as an air pump and cools the engine.

When this occurs, your vehicle still operates, however:

- Engine power is limited.
- The air conditioning system turns off.

Continued operation increases the engine temperature, causing the engine to completely shut down. Your steering and braking effort increases in this situation.

When the engine temperature cools, you can re-start the engine. Have your vehicle checked as soon as possible to minimize engine damage.

When Fail-Safe Mode Is Activated



WARNING: Fail-safe mode is for use during emergencies only. Operate your vehicle in fail-safe mode only as long as necessary to bring your vehicle to rest in a safe location and seek immediate repairs. When in fail-safe mode, your vehicle will have limited power, will not be able to maintain high-speed operation, and may completely shut down without warning, potentially losing engine power, power steering assist, and power brake assist, which may increase the possibility of a crash resulting in serious injury.

Maintenance



WARNING: Do not remove the coolant reservoir cap when the engine is on or the cooling system is hot. Wait 10 minutes for the cooling system to cool down. Cover the coolant reservoir cap with a thick cloth to prevent the possibility of scalding and slowly remove the cap. Failure to follow this instruction could result in personal injury.

Your vehicle has limited engine power when in the fail-safe mode, drive your vehicle with caution. Your vehicle does not maintain high-speed operation and the engine could operate poorly.

Remember that the engine is capable of automatically shutting down to prevent engine damage. In this situation:

1. Pull off the road as soon as safely possible and switch the engine off.
2. If you are a member of a roadside assistance program, we recommend that you contact your roadside assistance service provider.
3. If this is not possible, wait for a short period of time for the engine to cool.
4. Check the coolant level. If the coolant level is at or below the minimum mark, add prediluted coolant immediately.
5. When the engine temperature cools, you can re-start the engine. Have your vehicle checked as soon as possible to minimize engine damage.

Note: *Driving your vehicle without repair increases the chance of engine damage.*

Engine Coolant Temperature Management (If Equipped)



WARNING: To reduce the risk of crash and injury, be prepared that the vehicle speed may reduce and the vehicle may not be able to accelerate with full power until the coolant temperature reduces.

If you tow a trailer with your vehicle, the engine may temporarily reach a higher temperature during severe operating conditions, for example ascending a long or steep grade in high ambient temperatures.

At this time, you may notice the coolant temperature gauge moves toward the red zone and a message may appear in the information display.

You may notice a reduction in vehicle speed caused by reduced engine power in order to manage the engine coolant temperature. Your vehicle may enter this mode if certain high-temperature and high-load conditions take place. The amount of speed reduction depends on vehicle loading, grade and ambient temperature. If this occurs, there is no need to stop your vehicle. You can continue to drive.

The air conditioning may automatically turn on and off during severe operating conditions to protect the engine from overheating. When the coolant temperature decreases to the normal operating temperature, the air conditioning turns on.

If the coolant temperature gauge moves fully into the red zone, or if the coolant temperature warning or service engine soon messages appear in your information display, do the following:

Maintenance

1. Stop your vehicle as soon as it is safe to do so. Fully apply the parking brake, shift into park (P) or neutral (N).
2. Leave the engine running until the coolant temperature gauge needle returns to the normal position. If the temperature does not drop after several minutes, follow the remaining steps.
3. Switch the engine off and wait for it to cool. Check the coolant level.
4. If the coolant level is at or below the minimum mark, add prediluted coolant immediately.
5. If the coolant level is normal, restart the engine and continue.

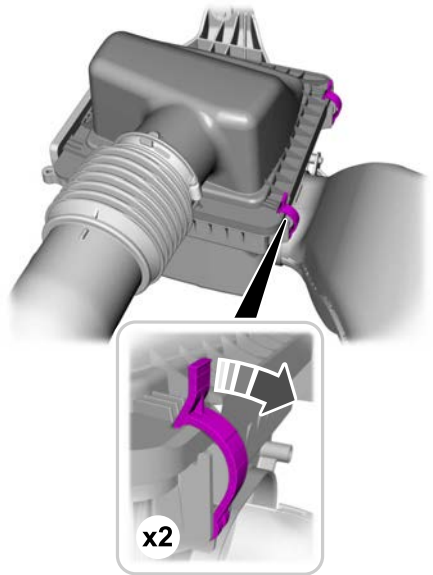

ENGINE AIR FILTER

CHANGING THE ENGINE AIR FILTER - GASOLINE



WARNING: To reduce the risk of vehicle damage and personal burn injuries, do not start your engine with the air cleaner removed and do not remove it while the engine is running.

Change the air filter element at the proper intervals. See **Scheduled Maintenance** (page 642).

When changing the air filter element, use only the air filter element listed. See **Capacities and Specifications** (page 558).

Note: *Failure to use the correct air filter element could result in severe engine damage that the vehicle Warranty may not cover.*

Note: *When servicing the air cleaner, do not allow foreign material to enter the air induction system. The engine is susceptible to damage from even small particles.*

1. Release the clips that secure the air filter cover to the housing.
2. Carefully lift the air filter housing cover.
3. Remove the air filter element from the air filter housing.
4. To install, reverse the removal procedure.

CHANGING THE FUEL FILTER - GASOLINE

Your vehicle has a lifetime fuel filter that integrates with the fuel tank. It does not need regular maintenance or replacement.

Maintenance

CHANGING THE 12V BATTERY

 **WARNING:** Batteries normally produce explosive gases which can cause personal injury. Therefore, do not allow flames, sparks or lighted substances to come near the battery. When working near the battery, always shield your face and protect your eyes. Always provide correct ventilation.

 **WARNING:** When lifting a plastic-cased battery, excessive pressure on the end walls could cause acid to flow through the vent caps, resulting in personal injury and damage to the vehicle or battery. Lift the battery with a battery carrier or with your hands on opposite corners.

 **WARNING:** Keep batteries out of reach of children. Batteries contain sulfuric acid. Avoid contact with skin, eyes or clothing. Shield your eyes when working near the battery to protect against possible splashing of acid solution. In case of acid contact with skin or eyes, flush immediately with water for a minimum of 15 minutes and get prompt medical attention. If acid is swallowed, call a physician immediately.

 **WARNING:** Battery posts, terminals and related accessories contain lead and lead compounds, chemicals known to the State of California to cause cancer and reproductive harm. **Wash your hands after handling.**

 **WARNING:** This vehicle may have more than one battery. Removing the battery cables from only one battery does not disconnect your vehicle electrical system. Make sure you disconnect the battery cables from all batteries when disconnecting power. Failure to do so may cause serious personal injury or property damage.

 **WARNING:** For vehicles with Auto-Start-Stop the battery requirement is different. You must replace the battery with one of exactly the same specification.

The battery is in the engine compartment. See **Under Hood Overview** (page 483).

Your vehicle has a maintenance-free battery. It does not require additional water during service.

If the vehicle battery has a cover and vent hose, make sure you correctly install it after cleaning or replacing the battery.

For longer, trouble-free operation, keep the top of the battery clean and dry and the battery cables tightly fastened to the battery terminals. If any corrosion is present on the battery or terminals, remove the cables from the terminals and clean with a wire brush. You can neutralize the acid with a solution of baking soda and water.

We recommend that you disconnect the negative battery cable terminal from the battery if you plan to store your vehicle for an extended period.

Note: *If you only disconnect the negative battery cable terminal, make sure it is isolated or placed away from the battery terminal to avoid unintended connection or arcing.*

Maintenance

If you replace the battery make sure it matches the electrical requirements of your vehicle.

If you disconnect or replace the battery and your vehicle has an automatic transmission, it must relearn its adaptive strategy. Because of this, the transmission may shift firmly when first driven. This is normal operation while the transmission fully updates its operation to optimum shift feel.

Battery Sensor Reset

When you install a new battery, reset the battery sensor by doing the following:

1. Switch the ignition on, and leave the engine off.

Note: Complete Steps 2 and 3 within 10 seconds.

2. Flash the high beam headlamps five times, ending with the high beams off.
3. Press and release the brake pedal three times.

The battery warning lamp flashes three times to confirm that the reset is successful.

Battery Management System (if Equipped)

The system monitors battery conditions and takes actions to extend battery life. If excessive battery drain is detected, the system temporarily disables some electrical systems to protect the battery.

Systems included are:

- Heated rear window.
- Heated seats.
- Climate control.
- Heated steering wheel.
- Audio unit.
- Navigation system.

A message may appear in the information display to alert you that battery protection actions are active. This message is only for notification that an action is taking place, and not intended to indicate an electrical problem or that the battery requires replacement.

After battery replacement, or in some cases after charging the battery with an external charger, the battery management system requires eight hours of vehicle sleep time to relearn the battery state of charge. During this time, your vehicle must remain fully locked with the ignition switched off.

Note: Prior to relearning the battery state of charge, the battery management system may temporarily disable some electrical systems.

Electrical Accessory Installation

To make sure the battery management system works correctly, do not connect an electrical device ground connection directly to the battery negative post. This can cause inaccurate measurements of the battery condition and potential incorrect system operation.

Note: If you add electrical accessories or components to the vehicle, it may adversely affect battery performance and durability. This may also affect the performance of other electrical systems in the vehicle.

Remove and Reinstall the Battery

Install a battery approved for use by our specifications. See **Capacities and Specifications** (page 558).

To disconnect or remove the battery, do the following:

1. Apply the parking brake and switch the ignition off.
2. Switch all electrical equipment off, for example lights and radio.

Maintenance

3. Wait a minimum of two minutes before disconnecting the battery.

Note: *The engine management system has a power hold function and remains powered for a period of time after you switch the ignition off. This is to allow the system to store diagnostic and adaptive tables. Disconnecting the battery without waiting can cause damage not covered by the vehicle warranty.*

4. Disconnect the negative battery cable terminal.
5. Disconnect the positive battery cable terminal.
6. Remove the battery securing clamp.
7. Remove the battery.
8. To install, reverse the removal procedure.

Note: *Before reconnecting the battery, make sure the ignition remains switched off.*

Note: *Make sure to fully tighten the battery cables.*

If you disconnect or replace the vehicle battery, you must reset the following features:

- Window bounce-back. See **Opening and Closing the Windows** (page 159).
- Clock Settings.
- Pre-set radio stations.

Battery Disposal



Make sure that you dispose of old batteries in an environmentally friendly way. Seek advice from your local authority about recycling old batteries.

ADJUSTING THE HEADLAMPS - VEHICLES WITH: LED HEADLAMPS

Vertical Aim Adjustment

We properly aim the headlamps on your vehicle at the assembly plant. If your vehicle has been in an accident, have your vehicle serviced as soon as possible to check and realign your headlamps.

Mid Series LED Headlamp Adjuster

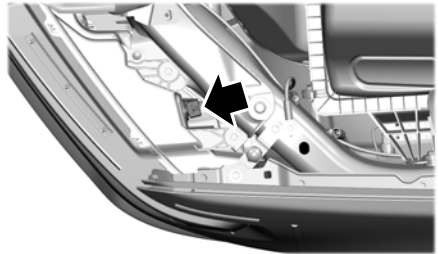

Hi Series LED Headlamp Adjuster

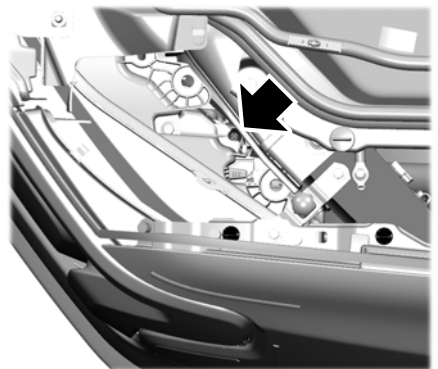

Maintenance

Headlamp Aiming Target

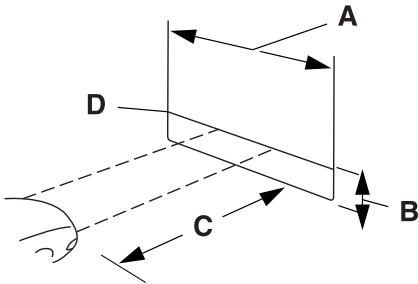

- A 8 feet (2.4 m).
 - B Center height of lamp to ground.
 - C 25 feet (7.6 m).
 - D Horizontal reference line.
1. Park your vehicle directly in front of a wall or screen on a level surface, approximately 25 ft (7.6 m) away.
 2. Measure the height from the center of your headlamp, indicated by a 3 millimeter circle on the lens, to the ground and mark an 8 ft (2.4 m) horizontal reference line on the vertical wall or screen at this height, a piece of masking tape works well.
 3. Switch on the low beam headlamps to illuminate the wall or screen and open the hood. Cover one of the headlamps so no light hits the wall.



4. On the wall or screen, observe a light pattern with a distinct horizontal edge toward the right. If this edge is not at the horizontal reference line, adjust the beam so the edge is at the same height as the horizontal reference line.
5. Locate the vertical adjuster on each headlamp. Use a #2 Phillips screwdriver to turn the adjuster either counterclockwise or clockwise in order to adjust the vertical aim of the headlamp.
6. Repeat Steps 3 through 7 to adjust the other headlamp.
7. Close the hood and turn off the lamps.

Horizontal Aim Adjustment

You do not need to perform horizontal aim for this vehicle. It is not adjustable.

ADJUSTING THE HEADLAMPS - VEHICLES WITH: HALOGEN HEADLAMPS

Vertical Aim Adjustment

The headlamps on your vehicle are properly aimed at the assembly plant. If your vehicle has been in an accident, contact an authorized dealer to check and realign your headlamps.

Maintenance

Headlamp Aiming Target

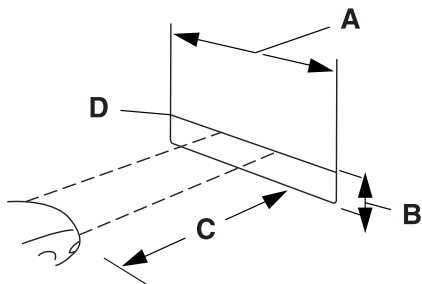

- A 8 feet (2.4 m).
- B Center height of lamp to ground.
- C 25 feet (7.6 m).
- D Horizontal reference line.

1. Park your vehicle directly in front of a wall or screen on a level surface, approximately 25 ft (7.6 m) away.
2. Measure the height from the center of your headlamp, indicated by a 3 millimeter circle on the lens, to the ground and mark an 8 ft (2.4 m) horizontal reference line on the vertical wall or screen at this height, a piece of masking tape works well.
3. Switch on the low beam headlamps to illuminate the wall or screen and open the hood. Cover one of the headlamps so no light hits the wall.



4. On the wall or screen, observe a light pattern with a distinct horizontal edge toward the right. If this edge is not at the horizontal reference line, adjust the beam so the edge is at the same height as the horizontal reference line.

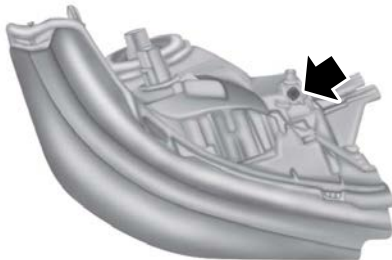

5. Locate the vertical adjuster on each headlamp. Use a #2 Phillips screwdriver to turn the adjuster either counterclockwise or clockwise in order to adjust the vertical aim of the headlamp.
6. Repeat Steps 3 through 7 to adjust the other headlamp.
7. Close the hood and turn off the lamps.

Horizontal Aim Adjustment

Horizontal aim is not required for this vehicle and is not adjustable.

Maintenance

EXTERIOR BULBS

EXTERIOR BULB SPECIFICATION CHART

Replacement bulbs are specified in the chart below. Headlamp bulbs must be

marked with an authorized D.O.T. marking for North America to make sure they have the proper lamp performance, light brightness, light pattern and safe visibility. The correct bulbs will not damage the lamp assembly or void the lamp assembly warranty and will provide quality bulb illumination time.

| Lamp | Specification | Power (Watt) |
|---|---------------|--------------|
| Central high mounted stop lamp. | 912 | 16 |
| Central high mounted cargo lamp. Vehicles with cargo box. | LED | LED |
| Daytime running lamp (XLT optional, Lariat, Platinum, King Ranch, Limited). | LED | LED |
| Daytime running lamp (XLT optional, XL). | H11 | 55 |
| Front turn signal and parking lamp (XLT optional, Lariat, Platinum, King Ranch, Limited). | LED | LED |
| Front turn signal and parking lamp (XLT optional, XL). | 4257NA | 21/5 |
| Front fog lamp (XLT optional, Lariat, Platinum, King Ranch, Limited). | LED | LED |
| Front fog lamp (XL and XLT optional). | 9140 | 55 |
| Front side marker lamp (Lariat optional, Platinum, King Ranch, Limited). | LED | LED |
| Front side marker lamp (Lariat optional, XL, XLT). | W5W | 5 |
| Headlamp (XLT optional, Lariat, Platinum, King Ranch, Limited). | LED | LED |
| Headlamp low beam (XLT optional, XL). | H11 | 55 |
| Headlamp high beam (XLT optional, XL). | 9005 | 65 |
| License plate lamp. | W5W | 5 |

Maintenance

| Lamp | Specification | Power (Watt) |
|--|---------------|--------------|
| Puddle lamp. | LED | LED |
| Rear cargo box lamp. | LED | LED |
| Rear turn signal (XL optional). | WTY21W | 21 |
| Rear lamp, stop lamp (XL optional). | WT21W/7W | 21/7 |
| Rear lamp, stop lamp, rear turn signal and rear side marker lamp (XL optional, XLT). | WT21W/7W | 21/7 |
| Reversing lamp (XL optional). | WT21W | 21 |
| Reversing lamp (XL optional, XLT). | LED | LED |
| Side turn signal lamp. | LED | LED |
| Taillamp-all functions (Lariat, Platinum, King Ranch, Limited). | LED | LED |

Note: LED lamps are not serviceable. See an authorized dealer if they fail.

Maintenance

REMOVING A REAR LAMP ASSEMBLY

1. Make sure the headlamps are off.
2. Open the tailgate to access the rear lamp assemblies.

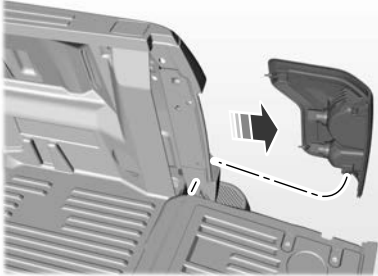

3. Remove the two bolts from the tail lamp assembly. Then, carefully pull the lamp assembly from the tailgate pillar by releasing the two retaining tabs.
4. Disconnect the electrical connector from the bulb.
5. To install, reverse the removal procedure.

CHANGING A HEADLAMP BULB



WARNING: Make sure the bulbs have cooled down before removing them. Failure to follow this warning could result in serious personal injury.

Accessing the Halogen High Beam and Low Beam Bulbs

1. Rotate the steering wheel to the opposite side of the bulb needing replacement.

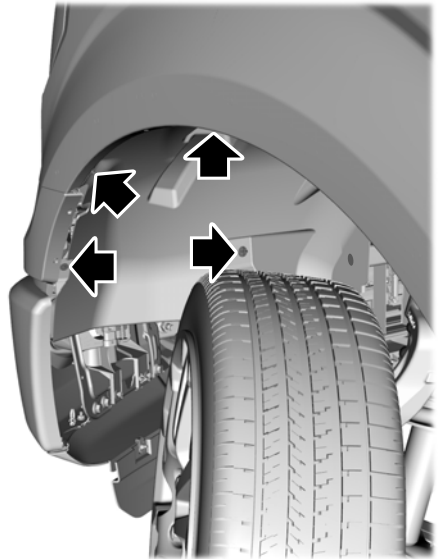

2. Remove the screws and push pins from the front of the wheel liner.
3. Pull the wheel liner back towards the tire to gain access to the bulbs.

Maintenance

Replacing the Halogen High Beam and Low Beam Bulbs

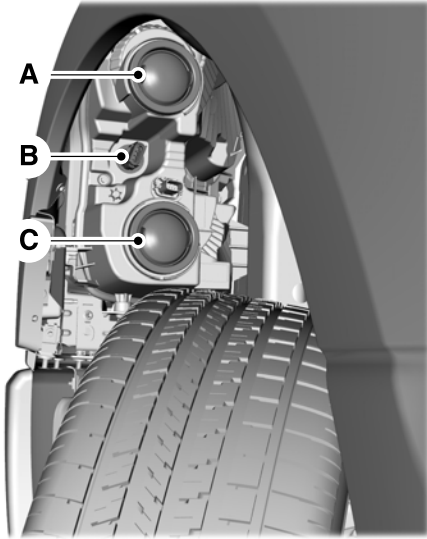

- A. Low beam headlamp bulb.
- B. Turn signal lamp bulb.
- C. High beam headlamp bulb.

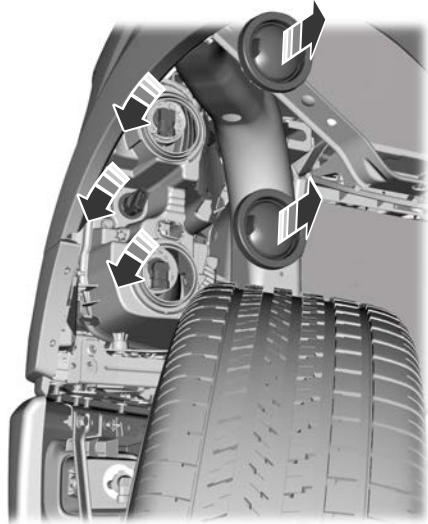

1. Make sure the headlamps are off.
2. For the high beam and low beam bulbs, remove the rubber cap to access the bulbs.
3. Remove the bulb holder from the lamp assembly by turning it counterclockwise and pulling it straight out.
4. Disconnect the bulb from the electrical connector.
5. To install, reverse the removal procedure.

Note: Handle a halogen headlamp bulb carefully and keep out of children's reach. Grasp the bulb only by its plastic base and do not touch the glass. The oil from your hand could cause the bulb to break the next time the headlamps are operated.

Maintenance

Note: If the bulb is accidentally touched, clean it with rubbing alcohol before installing it.

CHANGING A FRONT TURN SIGNAL LAMP BULB



WARNING: Make sure the bulbs have cooled down before removing them. Failure to follow this warning could result in serious personal injury.

1. Rotate the steering wheel to the opposite side of the bulb needing replacement.

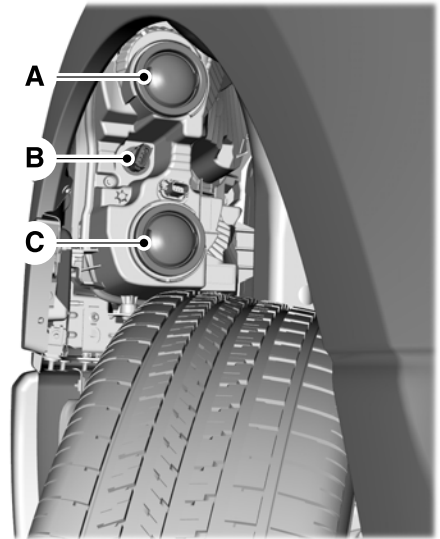
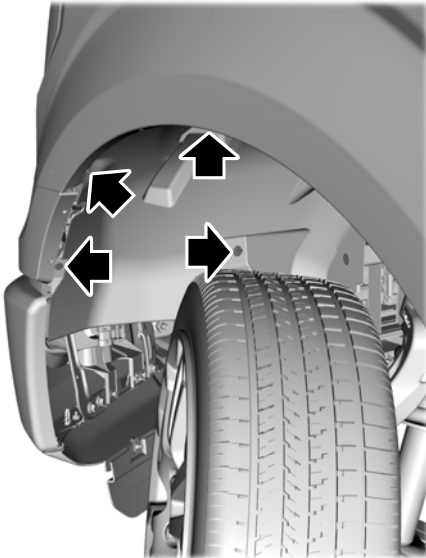

- A. Low beam headlamp bulb.
- B. Turn signal lamp bulb.
- C. High beam headlamp bulb.

2. Remove the screws and push pins from the front of the wheel liner.
3. Pull the wheel liner back toward the tire to gain access to the bulb.

Maintenance

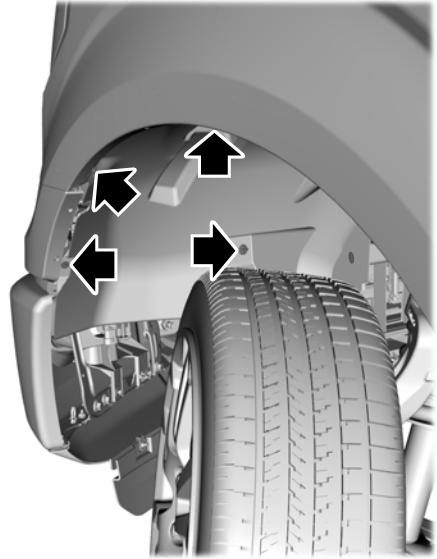

1. Make sure the headlamps are off.
 2. Remove the bulb holder from the lamp assembly by turning it counterclockwise and pulling it straight out.
 3. Disconnect the bulb from the electrical connector.
 4. To install, reverse the removal procedure.
2. Remove the screws and push pins from the front of the wheel liner.
 3. Pull the wheel liner back toward the tire to gain access to the bulb.

CHANGING A FRONT SIDE MARKER LAMP BULB

1. Rotate the steering wheel to the opposite side of the bulb needing replacement.

Maintenance

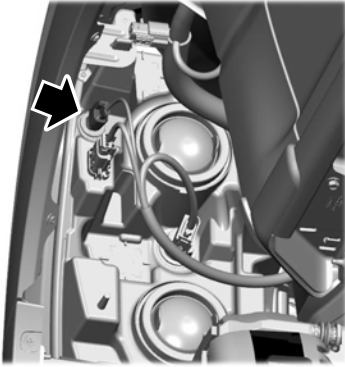

4. Remove the bulb holder from the lamp assembly by turning it counterclockwise and pulling it straight out.
5. Disconnect the bulb from the electrical connector.
6. To install, reverse the removal procedure.

CHANGING A FRONT FOG LAMP BULB (if Equipped)

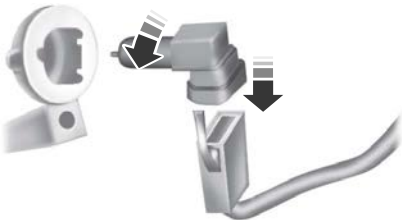

1. Make sure the fog lamps are off.

2. Disconnect the electrical connector from the fog lamp bulb.
3. Turn the bulb counterclockwise and remove it from the fog lamp.
4. To install, reverse the removal procedure.

CHANGING A REAR LAMP BULB

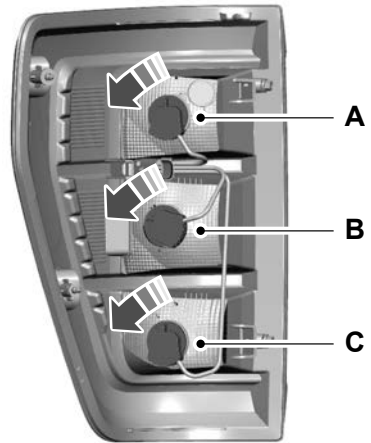

- A Turn signal bulb.
- B Reversing lamp bulb.
- C Rear and stoplamp bulb.

1. Remove the rear lamp assembly.
2. Rotate the bulb socket counterclockwise and remove it from the rear lamp assembly.
3. To install, reverse the removal procedure.

Maintenance

CHANGING A STOPLAMP BULB

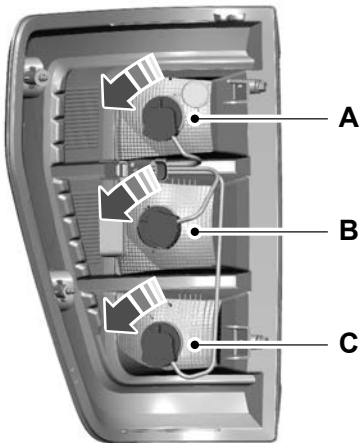

- A Turn signal bulb.
- B Reversing lamp bulb.
- C Rear and stoplamp bulb.

1. Remove the rear lamp assembly. See **Removing a Rear Lamp Assembly** (page 501).
2. Rotate the bulb socket counterclockwise and remove it from the rear lamp assembly.
3. To install, reverse the removal procedure.

CHANGING A REAR TURN SIGNAL LAMP BULB

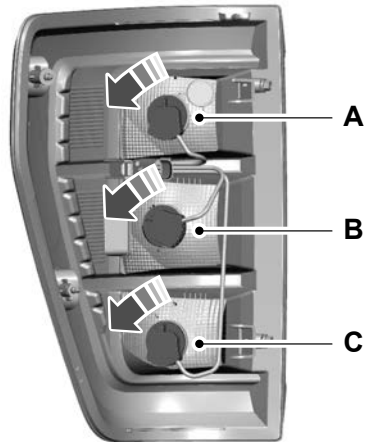

- A Turn signal bulb.
- B Reversing lamp bulb.
- C Rear and stoplamp bulb.

1. Remove the rear lamp assembly. See **Removing a Rear Lamp Assembly** (page 501).
2. Rotate the bulb socket counterclockwise and remove it from the rear lamp assembly.
3. To install, reverse the removal procedure.

Maintenance

CHANGING A REVERSING LAMP BULB

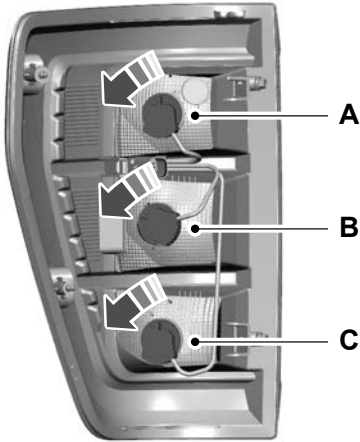

- A Turn signal bulb.
- B Reversing lamp bulb.
- C Rear and stoplamp bulb.

1. Remove the rear lamp assembly. See **Removing a Rear Lamp Assembly** (page 501).
2. Rotate the bulb socket counterclockwise and remove it from the rear lamp assembly.
3. To install, reverse the removal procedure.

CHANGING A HIGH MOUNTED STOPLAMP BULB

1. Make sure the lamps are off.
2. Remove the four screws and move the lamp assembly away from the vehicle to expose the bulb sockets.



3. Remove the bulb socket by rotating it counterclockwise and pulling it out of the lamp assembly.
4. Pull the bulb straight out of the socket.
5. To install, reverse the removal procedure.

CHANGING A LICENSE PLATE LAMP BULB

The license plate bulbs are behind the rear bumper.

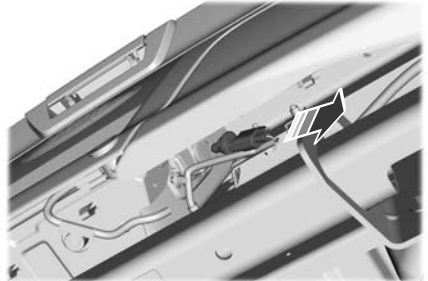

1. Reach behind the rear bumper to locate the bulb.
2. Twist the bulb socket counterclockwise and carefully pull to remove it from the lamp assembly.
3. Pull the bulb straight out of the socket.

Maintenance

- To install, reverse the removal procedure.

INTERIOR BULBS

INTERIOR BULB SPECIFICATION CHART

Your vehicle has LED lamps. These are not serviceable items. See an authorized dealer if they fail.

DRIVE BELT ROUTING - 2.7L ECOBOOST™, VEHICLES WITH: DUAL GENERATORS

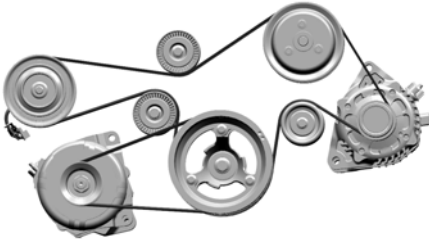

DRIVE BELT ROUTING - 2.7L ECOBOOST™, VEHICLES WITH: SINGLE GENERATOR

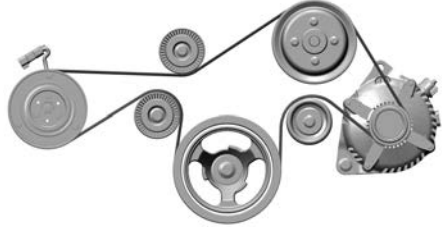

DRIVE BELT ROUTING - 3.3L

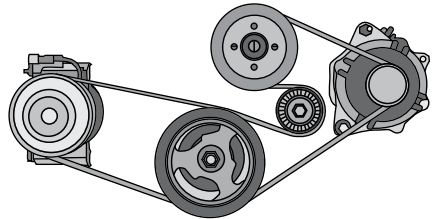

Note: The short drive belt is on the inner groove closest to the engine. The long drive belt is on the outer groove farthest from the engine.

Maintenance

DRIVE BELT ROUTING - 3.5L ECOBOOST™, VEHICLES WITH: DUAL GENERATORS

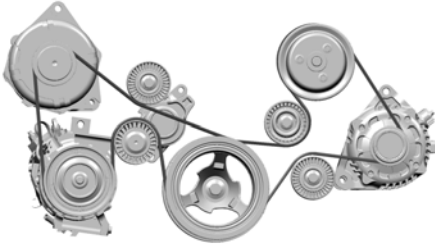

Note: The short drive belt is on the inner groove closest to the engine. The long drive belt is on the outer groove farthest from the engine.

DRIVE BELT ROUTING - 3.5L ECOBOOST™, VEHICLES WITH: SINGLE GENERATOR

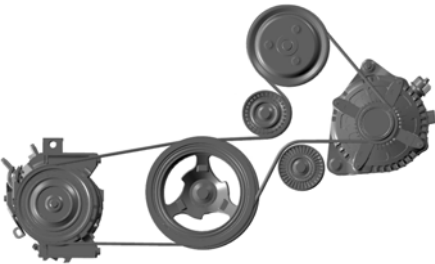

Note: The long drive belt is on the inner groove closest to the engine. The short drive belt is on the outer groove farthest from the engine.

DRIVE BELT ROUTING - 3.5L, HYBRID ELECTRIC VEHICLE (HEV)

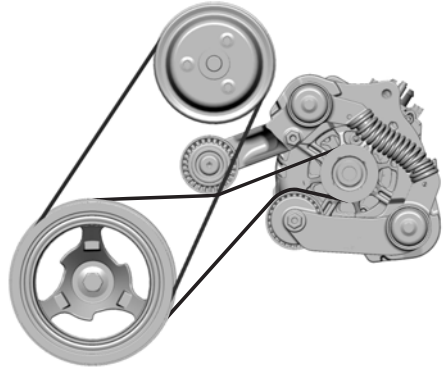

Note: The generator drive belt is on the inner groove closest to the engine. The water pump belt is on the outer groove farthest from the engine.

DRIVE BELT ROUTING - 5.0L, VEHICLES WITH: DUAL GENERATORS

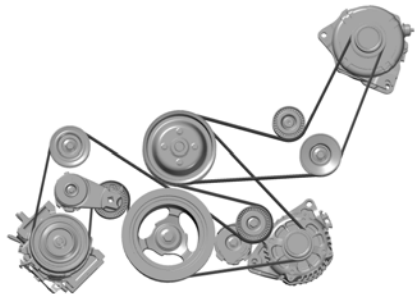

Maintenance

DRIVE BELT ROUTING - 5.0L, VEHICLES WITH: SINGLE GENERATOR

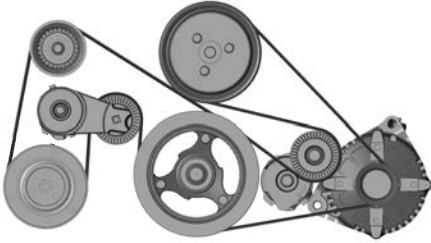

Vehicle Care

CLEANING PRODUCTS

Materials

For best results, use the following products

or products of equivalent quality:

For additional information and assistance, we recommend that you contact an authorized dealer.

| Name | Specification |
|--|---------------|
| Motorcraft® Bug and Tar Remover, ZC-42 (U.S. & Canada) | |
| Motorcraft® Custom Bright Metal Cleaner, ZC-15 (U.S. & Canada) | ESR-M5B194-B |
| Motorcraft® Detail Wash, ZC-3-A (U.S. & Canada) | ESR-M14P4-A |
| Motorcraft® Engine Shampoo and Degreaser, ZC-20 (U.S.) | ESR-M14P3-A |
| Motorcraft® Engine Shampoo, CXC-66-A (Canada) | |
| Motorcraft® Premium Leather and Vinyl Cleaner, ZC-56 (U.S. & Canada) | |
| Motorcraft® Multi-Purpose Cleaner, CXC-101 (Canada) | |
| Motorcraft® Premium Windshield Wash Concentrate with Bitterant, ZC-32-B2 (U.S.) | WSS-M14P19-A |
| Motorcraft® Premium Quality Windshield Washer Fluid, CXC-37-F/M (Canada) | WSS-M14P19-A |
| Motorcraft® Professional Strength Carpet & Upholstery Cleaner, ZC-54 (U.S. & Canada) | |
| Motorcraft® Premium Glass Cleaner, CXC-100 (Canada) | ESR-M14P5-A |
| Motorcraft® Spot and Stain Remover, ZC-14 (U.S.) | |
| Motorcraft® Ultra-Clear Spray Glass Cleaner, ZC-23 (U.S.) | ESR-M14P5-A |
| Motorcraft® Wheel and Tire Cleaner, ZC-37-A (U.S. & Canada) | |

CLEANING THE EXTERIOR

Remove any exterior accessories, for example antennas, before entering a car wash.

CLEANING THE EXTERIOR PRECAUTIONS

Immediately remove fuel spillages, additive residuals, bird droppings, insect deposits and road tar. These may cause damage to your vehicle's paintwork or trim over time.

Vehicle Care

CLEANING THE EXTERIOR PRECAUTIONS - RAPTOR

Do not drive your vehicle through an automated, commercial car wash due to the vehicle's tire width and track. Wash your vehicle by hand, or by using a touchless commercial wash with no mechanical tracks on the floor.

CLEANING HEADLAMPS AND REAR LAMPS

We recommend that you only use cold or lukewarm water containing car shampoo to clean the headlamps and the rear lamps.

Do not scrape the lamps.

Do not wipe lamps when they are dry.

CLEANING WINDOWS AND WIPER BLADES

To clean the windshield and wiper blades:

- Clean the windshield with a non-abrasive glass cleaner.

Note: *When cleaning the interior of the windshield, avoid getting any glass cleaner on the instrument panel or door panels. Wipe any glass cleaner off these surfaces immediately.*

- Clean the wiper blades with washer fluid or water applied with a soft sponge or cloth.

Note: *Do not use razor blades or other sharp objects to clean or remove decals from the inside of the heated rear window. This can cause damage not covered by the vehicle Warranty.*

CLEANING CHROME, ALUMINIUM OR STAINLESS STEEL

We recommend that you only use a car shampoo, a soft cloth and water on bumpers and other chrome, aluminium or stainless steel parts.

Note: *For additional information and assistance, we recommend that you contact an authorized dealer.*

Note: *Rinse the area well after cleaning.*

Note: *Do not use abrasive materials, for example steel wool or plastic pads, as they can scratch these surfaces.*

Note: *Do not use chrome cleaner, metal cleaner or polish on wheels or wheel covers.*

CLEANING WHEELS

Only use a recommended wheel and tire cleaner to clean the wheels weekly. For additional information and assistance, we recommend that you contact an authorized dealer.

1. Use a sponge to remove heavy deposits of dirt and brake dust.
2. Rinse well after cleaning.

Note: *Do not apply a cleaning chemical to warm or hot wheel rims and covers.*

If you intend on parking your vehicle for an extended period after cleaning the wheels with a wheel cleaner, drive your vehicle for a few minutes before parking your vehicle. This reduces the risk of corrosion of the brake discs, brake pads and linings.

Do not clean the wheels when they are hot.

Note: *Some car washes could damage wheel rims and covers.*

Note: *Using non-recommended cleaners, harsh cleaning products, chrome wheel cleaners or abrasive materials could damage wheel rims and covers.*

Vehicle Care

CLEANING THE ENGINE COMPARTMENT

Use a vacuum cleaner to remove debris from the screen area below windshield.

Note: *If you are not familiar with the parts around the engine do not wash the engine compartment. Avoid frequent engine washes.*

When washing the engine compartment:

- Never wash or rinse the engine while it is hot or running.
- Never wash or rinse any ignition coil, spark plug wire or spark plug well.
- Cover the battery, power distribution box, and air filter assembly to prevent water damage.

Note: *If your vehicle has an engine cover remove the cover before application of shampoo and degreaser.*

- Spray an approved engine shampoo and degreaser on all parts that require cleaning and rinse with water.

CLEANING STRIPES OR GRAPHICS

It is recommended to wash your vehicle by hand however, pressure washing may be used under the following conditions:

- Use a spray with a 40° wide spray angle pattern.
- Keep the nozzle at a 12 in (305 mm) distance and 90° angle to your vehicle's surface.
- Do not use water pressure higher than 2,000 psi (14,000 kPa).
- Do not use water hotter than 179°F (82°C).

Note: *Holding the pressure washer nozzle at an angle to the vehicle's surface may damage graphics and cause the edges to peel away from the vehicle's surface.*

CLEANING CAMERA LENSES AND SENSORS

We recommend that you only use lukewarm or cold water and a soft cloth to clean the camera lens and sensors.

Note: *Do not pressure wash camera lens and sensors.*

CLEANING THE UNDERBODY

Flush the complete underside of your vehicle frequently. Keep body and door drain holes free from packed dirt.

Rear suspension components may require regular cleaning with a power washer or a thorough rinse with a strong stream of water if the vehicle is operated in dusty or muddy environments. Rear leaf springs or other suspension components may emit squeaking or popping noises while operating the vehicle if particles, such as dirt, rocks, or other debris, are present in the components.

CLEANING THE INTERIOR

CLEANING THE INSTRUMENT PANEL



WARNING: Do not use chemical solvents or strong detergents when cleaning the steering wheel or instrument panel to avoid contamination of the airbag system.

We recommend that you only clean the instrument panel and cluster lens with a damp soft cloth. Dry the area with a clean, soft cloth.

For additional information and assistance, we recommend that you contact an authorized dealer.

Vehicle Care

Note: Avoid cleaners or polishes that increase the gloss of the upper portion of the instrument panel. The dull finish in this area helps protect you from undesirable windshield reflection.

CLEANING PLASTIC

We recommend that you only use a mild soap and water solution on a soft cloth. Dry the area with a clean, soft cloth.

CLEANING DISPLAYS AND SCREENS

We recommend that you only use a microfiber cloth in a circular motion to clean off the fingerprint or dust.

If dirt or fingerprints are still on the screen, apply a small amount of alcohol to the cloth and try to clean it again.

Note: Do not pour or spray alcohol onto the touchscreen.

Note: Do not use detergent or any type of solvent to clean the touchscreen.

CLEANING SEATS AND THE HEADLINER



WARNING: On vehicles equipped with seat-mounted airbags, do not use chemical solvents or strong detergents. Such products could contaminate the side airbag system and affect performance of the side airbag in a crash.

Cleaning Fabric Seats and the Headliner

We recommend that you only clean the fabric seats and headliners in the following way:

1. Remove dust and loose dirt with a vacuum cleaner.

2. Wipe the surface with a soft, damp cloth and a mild soap and water solution. Dry the area with a clean, soft cloth.
3. For additional information and assistance, we recommend that you contact an authorized dealer.

For heavy stains, spot clean the area. If a ring forms on the fabric, immediately clean the entire area, but do not oversaturate or the ring could set.

Cleaning Vinyl and Leather

We recommend that you only clean the leather and vinyl surfaces in the following way:

1. Remove dust and loose dirt with a vacuum cleaner.
2. Wipe the surface with a soft, damp cloth and a mild soap and water solution. Dry the area with a clean, soft cloth.
3. For additional information and assistance, we recommend that you contact an authorized dealer.

With King Ranch Edition

Your vehicle has seating covered in premium, top-grain leather that is extremely durable, but still requires special care and maintenance in order to preserve longevity and comfort.

Regular cleaning and conditioning maintains the appearance of the leather.

Scratches

Because the leather in the seat comes from genuine steer hides, there may be evidence of naturally occurring markings, such as small scars. These markings give character to the seating covers and are considered to be proof of a genuine leather product.

Vehicle Care

To lessen the appearance of certain scratches and other wear marks, apply conditioner on the affected area.

Conditioning

- Clean the surfaces using the steps outlined in the cleaning leather and vinyl section.
- Make sure the leather is dry then apply a nickel-sized amount of conditioner to a clean, dry cloth.
- Rub the conditioner into the leather until it disappears. Allow the conditioner to dry, then repeat the process for the entire interior. If a film appears, wipe it off with a dry, clean cloth.

For additional information, visit:
www.krsaddleshop.com

CLEANING CARPETS AND FLOOR MATS

We recommend that you only clean your carpets in the following way:

1. Remove dust and loose dirt with a vacuum cleaner.
2. Wipe the surface with a soft, damp cloth and a mild soap and water solution. Dry the area with a clean, soft cloth.
3. For additional information and assistance, we recommend that you contact an authorized dealer.

For heavy stains, spot clean the area. If a ring forms on the fabric, clean the entire area immediately, but do not oversaturate or the ring could set.

We recommend that you only clean your floor mats in the following way:

1. Remove dust and loose dirt with a vacuum cleaner.

2. Wash rubber floor mats using mild soap and lukewarm or cold water.
3. Completely dry the floor mat before placing them back in your vehicle.

CLEANING SEATBELTS



WARNING: Do not use cleaning solvents, bleach or dye on the vehicle's seatbelts, as these actions may weaken the belt webbing.

1. Wipe the surface with a soft, damp cloth and a mild soap and water solution. Dry the area with a clean, soft cloth.

CLEANING MOONROOF TRACKS

1. Remove debris from the tracks with a vacuum cleaner.
2. Wipe the bulb seal and mating painted roof metal surface with a soft, damp cloth and a mild soap and water solution.

Note: *The moonroof rail tracks are greased to maintain proper functionality. Do not wipe off the grease.*

REPAIRING MINOR PAINT DAMAGE

Authorized dealers have touch-up paint to match your vehicle's color. Your vehicle color code is printed on a sticker on the front, left-hand side door jamb. Take your color code to your authorized dealer to make sure you get the correct color.

Before repairing minor paint damage, use a cleaner to remove particles such as bird droppings, tree sap, insect deposits, tar spots, road salt and industrial fallout.

Vehicle Care

Read the instructions before using cleaning products.

WAXING YOUR VEHICLE

Wax the high-gloss painted surface of your prewashed vehicle once or twice a year.

We recommend that you only use an approved quality wax that does not contain abrasives. Follow the manufacturer's instructions to apply and remove the wax. For additional information and assistance, we recommend that you contact an authorized dealer.

When washing and waxing, park your vehicle in a shaded area out of direct sunlight.

Note: *Avoid waxing unpainted or low-gloss black colored parts, they discolor over time.*

Storing Your Vehicle

PREPARING YOUR VEHICLE FOR STORAGE

If you plan on storing your vehicle for 30 days or more, the following maintenance recommendations ensures your vehicle stays in good operating condition.

Under various conditions, long-term storage may lead to degraded engine performance or failure unless you use specific precautions to preserve your vehicle.

General

- Store all vehicles in a dry, ventilated place.
- If vehicles are stored outside, they require regular maintenance to protect against rust and weather damage.
- Make sure all linkages, cables, levers and pins under your vehicle are covered with grease to prevent rust.
- Move vehicles at least 25 ft (7.5 m) every 15 days to lubricate working parts and prevent corrosion.
- Fill the fuel tank with high-quality fuel until the first automatic shutoff of the fuel pump nozzle.

Engine

- Change the engine oil and filter prior to storage because used engine oil contains contaminants which may cause engine damage.
- Start the engine every 15 days for a minimum of 15 minutes. Run at fast idle with the climate controls set to defrost until the engine reaches normal operating temperature.
- With your foot on the brake, shift through all the gears while the engine is running.

Body

- Wash your vehicle thoroughly to remove dirt, grease, oil, tar or mud from exterior surfaces, rear-wheel housings and the underside of front fenders.
- Periodically wash your vehicle if it is stored in exposed locations.
- Touch-up exposed or primed metal to prevent rust.
- Cover chrome and stainless steel parts with a thick coat of auto wax to prevent discoloration. Re-wax as necessary when you wash your vehicle.
- Lubricate all hood, door and luggage compartment hinges and latches with a light grade oil.
- Cover interior trim to prevent fading.
- Keep all rubber parts free from oil and solvents.

Hybrid Battery Systems

We recommend the following actions for your vehicle:

- When storing your vehicle for greater than 30 days the state of charge should be approximately 50%. Additionally we recommend disconnecting the 12V battery which will reduce system loads on the HV battery.

12 Volt Battery

- Check and recharge as necessary. Keep connections clean.

Note: *It is necessary to reset memory features if you disconnect the battery cables.*

Brakes

Make sure the brakes and parking brake release fully.

Storing Your Vehicle

Note: *If you intend on parking your vehicle for an extended period after cleaning the wheels with a wheel cleaner, drive your vehicle for a few minutes before doing so to reduce the risk of increased corrosion of the brake discs, brake pads and linings.*

Tires

- Maintain recommended air pressure.

Note: *If you intend on parking your vehicle for an extended period after cleaning the wheels with a wheel cleaner, drive your vehicle for a few minutes before doing so. This reduces the risk of corrosion of the brake discs, brake pads and linings.*

- Check fluid levels (including coolant, oil and gas) to make sure there are no leaks, and fluids are at recommended levels.
- If you remove the battery, clean the battery cable ends and check for damage.

Contact an authorized dealer if you have any concerns or issues.

REMOVING YOUR VEHICLE FROM STORAGE

When your vehicle is ready to come out of storage, do the following:

- We recommend that you change the engine oil before you use your vehicle again.
- Wash your vehicle to remove any dirt or grease film build-up on window surfaces.
- Check windshield wipers for any deterioration.
- Check under the hood for any foreign material that may have collected during storage such as mice or squirrel nests.
- Check the exhaust for any foreign material that may have collected during storage.
- Check tire pressures and set tire inflation per the Tire Label.
- Check brake pedal operation. Drive your vehicle 15 ft (4.5 m) back and forth to remove rust build-up.

Wheel and Tire Information

LOCATING THE TIRE LABEL

You will find a Tire Label containing tire inflation pressure by tire size and other important information located on the B-Pillar or the edge of the driver's door. See **Locating the Safety Compliance Certification Labels** (page 389).

DEPARTMENT OF TRANSPORTATION UNIFORM TIRE QUALITY GRADES



Tire Quality Grades apply to new pneumatic passenger car tires. The Quality grades can be found where applicable on the tire sidewall between tread shoulder and maximum section width. For example: **Treadwear 200 Traction AA Temperature A.**

These Tire Quality Grades are determined by standards that the United States Department of Transportation has set.

Tire Quality Grades apply to new pneumatic passenger car tires. They do not apply to deep tread, winter-type snow tires, space-saver or temporary use spare tires, light truck or LT type tires, tires with nominal rim diameters of 10 to 12 inches or limited production tires as defined in Title 49 Code of Federal Regulations Part 575.104 (c)(2).

U.S. Department of Transportation Tire quality grades: The U.S. Department of Transportation requires us to give you the following information about tire grades exactly as the government has written it.

Treadwear

The treadwear grade is a comparative rating based on the wear rate of the tire when tested under controlled conditions on a specified government test course. For example, a tire graded 150 would wear 1½ times as well on the government course as a tire graded 100. The relative performance of tires depends upon the actual conditions of their use, however, and may depart significantly from the norm due to variations in driving habits, service practices, and differences in road characteristics and climate.

Wheel and Tire Information

Traction AA A B C



WARNING: The traction grade assigned to this tire is based on straight-ahead braking traction tests, and does not include acceleration, cornering, hydroplaning or peak traction characteristics.

The traction grades, from highest to lowest are AA, A, B, and C. The grades represent the tire's ability to stop on wet pavement as measured under controlled conditions on specified government test surfaces of asphalt and concrete. A tire marked C may have poor traction performance.

Temperature A B C



WARNING: The temperature grade for this tire is established for a tire that is properly inflated and not overloaded. Excessive speed, underinflation, or excessive loading, either separately or in combination, can cause heat buildup and possible tire failure.

The temperature grades are A (the highest), B and C, representing the tire's resistance to the generation of heat and its ability to dissipate heat when tested under controlled conditions on a specified indoor laboratory

test wheel. Sustained high temperature can cause the material of the tire to degenerate and reduce tire life, and excessive temperature can lead to sudden tire failure. The grade C corresponds to a level of performance which all passenger car tires must meet under the Federal Motor Vehicle Safety Standard No. 139. Grades B and A represent higher levels of performance on the laboratory test wheel than the minimum required by law.

INFORMATION ON THE TIRE SIDEWALL

Both United States and Canada Federal regulations require tire manufacturers to place standardized information on the sidewall of all tires. This information identifies and describes the fundamental characteristics of the tire and also provides a U.S. DOT Tire Identification Number for safety standard certification and in case of a recall.

Wheel and Tire Information

Information on P Type Tires

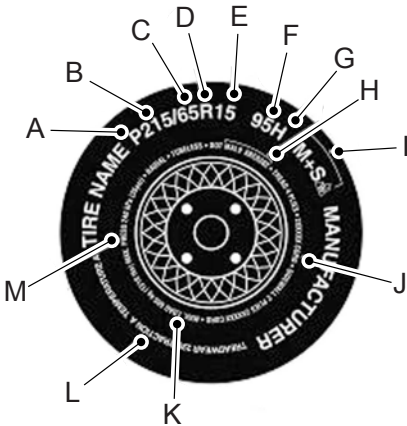

P215/65R15 95H is an example of a tire size, load index and speed rating. The definitions of these items are listed below. (Note that the tire size, load index and speed rating for your vehicle may be different from this example.)

A. P: Indicates a tire, designated by the Tire and Rim Association, that may be used for service on cars, sport utility vehicles, minivans and light trucks. **Note:** If your tire size does not begin with a letter this may mean it is designated by either the European Tire and Rim Technical Organization or the Japan Tire Manufacturing Association.

B. 215: Indicates the nominal width of the tire in millimeters from sidewall edge to sidewall edge. In general, the larger the number, the wider the tire.

C. 65: Indicates the aspect ratio which gives the tire's ratio of height to width.

D. R: Indicates a radial type tire.

E. 15: Indicates the wheel or rim diameter in inches. If you change your wheel size, you will have to purchase new tires to match the new wheel diameter.

F. 95: Indicates the tire's load index. It is an index that relates to how much weight a tire can carry. You may find this information in your owner's manual. If not, contact a local tire dealer.

Note: You may not find this information on all tires because it is not required by federal law.

G. H: Indicates the tire's speed rating. The speed rating denotes the speed at which a tire is designed to be driven for extended periods of time under a standard condition of load and inflation pressure. The tires on your vehicle may operate at different conditions for load and inflation pressure. These speed ratings may need to be adjusted for the difference in conditions. The ratings range from 81 mph (130 km/h) to 186 mph (299 km/h). These ratings are listed in the following chart.

Wheel and Tire Information

Note: You may not find this information on all tires because it is not required by federal law.

| Letter rating | Speed rating |
|---------------|--------------------|
| M | 81 mph (130 km/h) |
| N | 87 mph (140 km/h) |
| Q | 99 mph (159 km/h) |
| R | 106 mph (171 km/h) |
| S | 112 mph (180 km/h) |
| T | 118 mph (190 km/h) |
| U | 124 mph (200 km/h) |
| H | 130 mph (210 km/h) |
| V | 149 mph (240 km/h) |
| W | 168 mph (270 km/h) |
| Y | 186 mph (299 km/h) |

Note: For tires with a maximum speed capability over 149 mph (240 km/h), tire manufacturers sometimes use the letters ZR. For those with a maximum speed capability over 186 mph (299 km/h), tire manufacturers always use the letters ZR.

H. U.S. DOT Tire Identification Number (TIN): This begins with the letters DOT and indicates that the tire meets all federal standards. The next two numbers or letters are the plant code designating where it was manufactured, the next two are

the tire size code and the last four numbers represent the week and year the tire was built. For example, the numbers 317 mean the 31st week of 1997. After 2000, the numbers go to four digits. For example, 2501 means the 25th week of 2001. The numbers in between are identification codes used for traceability. This information is used to contact customers if a tire defect requires a recall.

I. M+S or M/S: Mud and Snow, or

AT: All Terrain, or

AS: All Season.

J. Tire Ply Composition and Material Used: Indicates the number of plies or the number of layers of rubber-coated fabric in the tire tread and sidewall. Tire manufacturers also must indicate the ply materials in the tire and the sidewall, which include steel, nylon, polyester, and others.

K. Maximum Load: Indicates the maximum load in kilograms and pounds that can be carried by the tire. See the Safety Compliance Certification Label (affixed to either the door hinge pillar, door-latch post, or the door edge that meets the door-latch post, next to the driver's seating position), for the correct tire pressure for your vehicle.

L. Treadwear, Traction and Temperature Grades:

Wheel and Tire Information

***Treadwear:** The treadwear grade is a comparative rating based on the wear rate of the tire when tested under controlled conditions on a specified government test course. For example, a tire graded 150 would wear one and one-half times as well on the government course as a tire graded 100.

***Traction:** The traction grades, from highest to lowest are AA, A, B, and C. The grades represent the tire's ability to stop on wet pavement as measured under controlled conditions on specified government test surfaces of asphalt and concrete. A tire marked C may have poor traction performance.

***Temperature:** The temperature grades are A (the highest), B and C, representing the tire's resistance to the generation of heat and its ability to dissipate heat when tested under controlled conditions on a specified indoor laboratory test wheel.

M. Maximum Inflation Pressure: Indicates the tire manufacturers' maximum permissible pressure or the pressure at which the maximum load can be carried by the tire. This pressure is normally higher than the vehicle manufacturer's recommended cold inflation pressure which can be found on the Safety Compliance Certification Label (affixed to either the door hinge pillar,

door-latch post, or the door edge that meets the door-latch post, next to the driver's seating position), or Tire Label which is located on the B-Pillar or the edge of the driver's door. The cold inflation pressure should never be set lower than the recommended pressure on the vehicle label.

The tire suppliers may have additional markings, notes or warnings such as standard load or radial tubeless.

Additional Information Contained on the Tire Sidewall for LT Type Tires

Note: *Tire Quality Grades do not apply to this type of tire.*

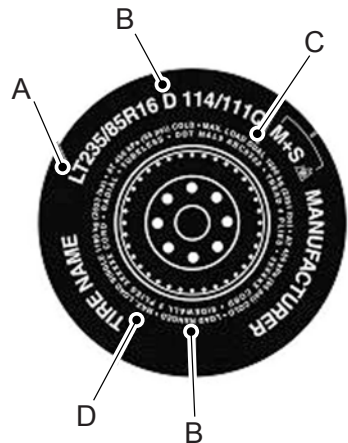

Wheel and Tire Information

LT type tires have some additional information beyond those of P type tires; these differences are described below.

A. **LT:** Indicates a tire, designated by the Tire and Rim Association, that is intended for service on light trucks.

B. **Load Range and Load Inflation Limits:** Indicates the tire's load-carrying capabilities and its inflation limits.

C. **Maximum Load Dual lb (kg) at psi (kPa) cold:** Indicates the maximum load and tire pressure when the tire is used as a dual, defined as four tires on the rear axle (a total of six or more tires on the vehicle).

D. **Maximum Load Single lb (kg) at psi (kPa) cold:** Indicates the maximum load and tire pressure when the tire is used as a single, defined as two tires (total) on the rear axle.

Information on T Type Tires

T145/80D16 is an example of a tire size.

Note: *The temporary tire size for your vehicle may be different from this example. Tire Quality Grades do not apply to this type of tire.*

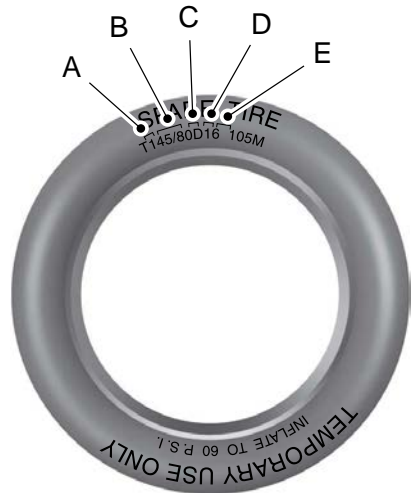

T type tires have some additional information beyond those of P type tires; these differences are described below:

A. **T:** Indicates a type of tire, designated by the Tire and Rim Association, that is intended for temporary service on cars, sport utility vehicles, minivans and light trucks.

B. **145:** Indicates the nominal width of the tire in millimeters from sidewall edge to sidewall edge. In general, the larger the number, the wider the tire.

Wheel and Tire Information

C. **80:** Indicates the aspect ratio which gives the tire's ratio of height to width. Numbers of 70 or lower indicate a short sidewall.

D. **D:** Indicates a diagonal type tire.

R: Indicates a radial type tire.

E. **16:** Indicates the wheel or rim diameter in inches. If you change your wheel size, you will have to purchase new tires to match the new wheel diameter.

GLOSSARY OF TIRE TERMINOLOGY

***Tire label:** A label showing the original equipment tire sizes, recommended inflation pressure and the maximum weight the vehicle can carry.

***Tire Identification Number (TIN):** A number on the sidewall of each tire providing information about the tire brand and manufacturing plant, tire size and date of manufacture. Also referred to as DOT code.

***Inflation pressure:** A measure of the amount of air in a tire.

***Standard load:** A class of P-metric or Metric tires designed to carry a maximum load at set pressure. For example: For P-metric tires 35 psi (2.4 bar) and for Metric tires 36 psi (2.5 bar). Increasing the inflation pressure beyond this pressure will not increase the tire's load carrying capability.

***Extra load:** A class of P-metric or Metric tires designed to carry a heavier maximum load at 42 psi (2.9 bar). Increasing the inflation pressure beyond this pressure will not increase the tire's load carrying capability.

***kPa:** Kilopascal, a metric unit of air pressure.

***PSI:** Pounds per square inch, a standard unit of air pressure.

***Cold tire pressure:** The tire pressure when the vehicle has been stationary and out of direct sunlight for an hour or more and prior to the vehicle being driven for 1 mi (1.6 km).

***Recommended inflation pressure:** The cold inflation pressure found on the Safety Compliance Certification Label (affixed to either the door hinge pillar, door-latch post, or the door edge that meets the door-latch post, next to the driver's seating position), or Tire Label located on the B-Pillar or the edge of the driver door.

* **B-pillar:** The structural member at the side of the vehicle behind the front door.

***Bead area of the tire:** Area of the tire next to the rim.

* **Sidewall of the tire:** Area between the bead area and the tread.

Wheel and Tire Information

***Tread area of the tire:** Area of the perimeter of the tire that contacts the road when mounted on the vehicle.

***Rim:** The metal support (wheel) for a tire or a tire and tube assembly upon which the tire beads are seated.

TIRE REPLACEMENT REQUIREMENTS

AGE



WARNING: Tires degrade over time depending on many factors such as weather, storage conditions, and conditions of use (load, speed, inflation pressure) the tires experience throughout their lives.

In general, tires should be replaced after six years regardless of tread wear. However, heat caused by hot climates or frequent high loading conditions can accelerate the aging process and may require tires to be replaced more frequently.

You should replace your spare tire when you replace the road tires or after six years due to aging even if it has not been used.

U.S. DOT Tire Identification Number

Both United States and Canada Federal regulations require tire manufacturers to place standardized information on the sidewall of all tires. This information identifies and describes the fundamental characteristics of the tire and also provides a U.S. DOT Tire Identification Number for safety standard certification and in case of a recall.

This begins with the letters DOT and indicates that the tire meets all federal standards. The next two numbers or letters are the plant code designating where it was manufactured, the next two are the tire size code and the last four numbers represent the week and year the tire was built. For example, the numbers 317 mean the 31st week of 1997. After 2000, the numbers go to four digits. For example, 2501 means the 25th week of 2001. The numbers in between are identification codes used for traceability. This information is used to contact customers if a tire defect requires a recall.

Tire Replacement Requirements

Your vehicle is equipped with tires designed to provide a safe ride and handling capability.

Wheel and Tire Information



WARNING: Only use replacement tires and wheels that are the same size, load index, speed rating and type (such as P-metric versus LT-metric or all-season versus all-terrain) as those originally provided by Ford. The recommended tire and wheel size may be found on either the Safety Compliance Certification Label (affixed to either the door hinge pillar, door-latch post, or the door edge that meets the door-latch post, next to the driver's seating position), or the Tire Label which is located on the B-Pillar or edge of the driver's door. If this information is not found on these labels, then you should contact your authorized dealer as soon as possible. Use of any tire or wheel not recommended by Ford can affect the safety and performance of your vehicle, which could result in an increased risk of loss of vehicle control, vehicle rollover, personal injury and death.



WARNING: To reduce the risk of serious injury, when mounting replacement tires and wheels, you should not exceed the maximum pressure indicated on the sidewall of the tire to set the beads without additional precautions listed below. If the beads do not seat at the maximum pressure indicated, re-lubricate and try again.



WARNING: For a mounting pressure more than 20 psi (1.38 bar) greater than the maximum pressure, a Ford dealer or other tire service professional should do the mounting.



WARNING: Always inflate steel carcass tires with a remote air fill with the person inflating standing at a minimum of 12 ft (3.66 m) away from the wheel and tire assembly.



WARNING: When inflating the tire for mounting pressures up to 20 psi (1.38 bar) greater than the maximum pressure on the tire sidewall, the following precautions must be taken to protect the person mounting the tire:

- Make sure that you have the correct tire and wheel size.
- Lubricate the tire bead and wheel bead seat area again.

Wheel and Tire Information

- Stand at a minimum of 12 ft (3.66 m) away from the wheel and tire assembly.
- Use both eye and ear protection.

Important: Remember to replace the wheel valve stems when the road tires are replaced on your vehicle.

It is recommended that the two front tires or two rear tires generally be replaced as a pair if the worn tires still have usable depth.

To avoid potential Four-Wheel Drive (4WD) malfunction or (4WD) system damage, it is recommended to replace all four tires rather than mixing significantly worn tires with new tires.

The tire pressure sensors mounted in the wheels (originally installed on your vehicle) are not designed to be used in aftermarket wheels.

The use of wheels or tires not recommended may affect the operation of your tire pressure monitoring system.

If the tire pressure monitoring system indicator is flashing, your system is malfunctioning. Your replacement tire might be incompatible with your tire pressure monitoring system, or some component of the system may be damaged.

USING SNOW CHAINS

 **WARNING:** Do not exceed 30 mph (50 km/h). Failure to follow this instruction could result in the loss of control of your vehicle, personal injury or death.

 **WARNING:** Do not use snow chains on snow-free roads.

 **WARNING:** Only fit snow chains to specified tires.

 **WARNING:** If your vehicle is fitted with wheel trims, remove them before fitting snow chains.

 **WARNING:** If you choose to install snow tires on your vehicle, they must be the same size, construction, and load range as the original tires listed on the tire placard, and they must be installed on all four wheels. Mixing tires of different size or construction on your vehicle can adversely affect your vehicle's handling and braking, and may lead to loss of vehicle control.

 **WARNING:** Wheels and tires must be the same size, load index and speed rating as those originally fitted on the vehicle. Use of any other tire or wheel can affect the safety and performance of your vehicle. Additionally, the use of non-recommended tires and wheels can cause steering, suspension, axle, transfer case or power transfer unit failure. Follow the recommended tire inflation pressures found on the Safety Compliance Certification label, or the Tire Label on the B-Pillar or the edge of the driver door. Failure to follow this instruction could result in loss of vehicle control, vehicle rollover, or personal injury or death.

Wheel and Tire Information

Only use snow chains on rear wheels. Install snow chains in pairs. Do not use self-tensioning snow chains.

Only use snow chains on the following specified tire sizes. Only install chains that are 15mm or less (SAE Class S chains).

- 245/70R17
- 265/70R17
- LT265/70R17
- 265/60R18
- LT265/70R18

We recommend you use steel wheels of the same size and specification if snow chains are required because chains may chip aluminum wheels.

Follow these guidelines when using snow tires and traction devices:

- If possible, avoid fully loading your vehicle.
- Purchase snow chains from a manufacturer that clearly labels body to tire dimension restrictions.
- When driving with snow chains do not exceed 30 mph (50 km/h) or the maximum speed recommended by the chain manufacturer, whichever is less.
- Drive cautiously. If you hear the snow chains rub or bang against the vehicle, stop and tighten them. If this does not work, remove the snow chains to prevent vehicle damage.
- Remove the snow chains when they are no longer needed. Do not use snow chains on dry roads.
- If a temporary spare wheel is mounted on your vehicle, do not use snow chains on the axle with the temporary spare wheel.

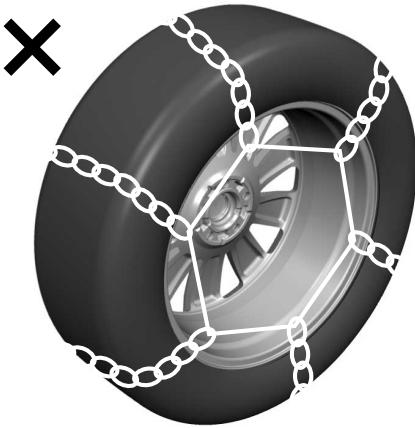

Use snow chains that fit against the sidewall of the tire to prevent the chains from touching the wheel rims or suspension. Refer to the previous illustration.

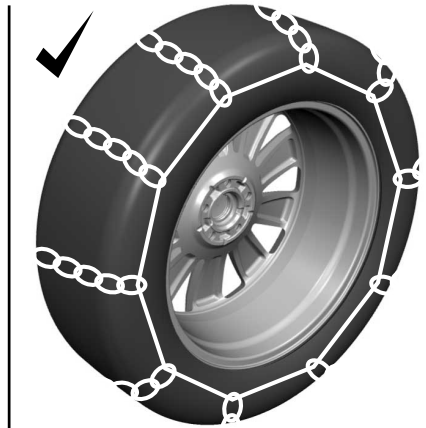

If you have any questions regarding snow chains, please contact your authorized dealer.

Wheel and Tire Information

USING BEAD-LOCK WHEELS - RAPTOR

Your vehicle comes with unique wheels matched to the tires. To avoid damage to your wheels:

- Maintain proper tire pressure.
- Due to extreme tire and wheel width, do not take your vehicle through an automatic car wash that uses mechanical tracks, as wheel damage may result.
- When installing wheels, always torque lug nuts to specification with a torque wrench.
- Inspect your wheels for damage on a regular basis. If you have a damaged wheel, replace it immediately.
- If you encounter an abnormally harsh impact, inspect the outside tire wall of your wheels, both inside and out, for damage.

Note: *Ford Performance only recommends using bead-lock rings from Ford Performance Parts, in conjunction with the original equipment manufacturer (OEM) tire. Any other combination using this wheel could result in air loss or tire failure.*

Note: *Converting the bead-lock compatible wheel to true bead-locks is for off-road use only. We do not approve of the use of true bead-locks for on-road driving.*

If your vehicles equipped with the optional bead lock compatible wheel, you can convert this wheel to use a true bead-lock ring, which allows operation at low tire pressures when off-road to minimize the risk of de-beading the tire. See your local Ford Performance Parts Dealer for more information.

Tire Care



WARNING: Always re-inflate tires to recommended tire pressures before the vehicle is operated on-road. The recommended pressure is located on the tire label or safety certification label, located on the B-pillar, inside the driver's door.



WARNING: After off-road use, before returning to the road, check the wheels and tires for damage. Off-road use may cause damage to your wheels and tires that can lead to tire failure, loss of vehicle control, serious injury or death.



WARNING: Replace the wheels and tires with the exact original brand, size and construction that came originally on your vehicle. Use of any other wheel or tire combinations, even with identical size ratings, may result in insufficient running clearances, tire rubbing and eventual puncture. Failure to follow tire replacement recommendations can lead to tire failure, loss of vehicle control, serious injury or death.

Note: *If you have reduced your tire pressure for off-road use, the tire pressure monitoring system (TPMS) warning light then activates in the instrument panel as a reminder to re-inflate the tires before returning to the road.*

Wheel and Tire Information

Your vehicle comes with high performance, all-terrain tires designed to optimize handling, steering and braking to provide the performance you expect in a Ford Performance vehicle. These tires are optimized for both on and off-road performance, and their ride, noise and wear characteristics are different from other tires. Also, because of their aggressive tread profile, it is important that you maintain your tires properly.

- Always maintain your tire pressures according to the tire information placard located on the driver's door B-pillar, using an accurate gauge. Remember to be prepared to re-inflate your tires before returning to the road. If a tire filling station is not available, remember to prepare a supplemental means to inflate the tires, such as a portable compressor.
- Check and set the tire pressures when the tires are cold, and not warm from driving. Wait at least three hours after parking the vehicle before checking tire pressure. Do not reduce the pressure of warm tires.
- Check your tire pressure often to maintain it properly. Tire pressure can decrease over time and fluctuate with temperature.
- Do not overload your vehicle. Maximum vehicle and axle weights are on the tire information placard.
- Use extra caution when operating the vehicle near its maximum load, including assuring proper tire pressure and reducing speeds.
- If you encounter an abnormally harsh impact, inspect your tires for damage.
- Inspect your tires for damage on a regular basis. Replace a damaged tire immediately.

- We do not approve the use of snow chains on your vehicle's tires.
- Proper suspension alignment is critical for maximum performance and optimal tire wear. If you notice uneven tire wear, have your alignment checked.

Spare Tire and Wheel

Your vehicle comes with a full size matching spare with an all-terrain tire. The spare tire and wheel assembly has the same capability as the road tire and wheel assemblies but does not come with a tire pressure monitoring sensor.

| Tires | Wheels |
|--------------|---------------|
| LT315/70R17 | 17x8.5, 34 ET |
| 37x12.5R17LT | 17x8.5, 30 ET |

Tire Care

CHECKING THE TIRE PRESSURES

Safe operation of your vehicle requires that your tires are properly inflated. Every day before you drive, check your tires.

At least once a month and before long trips, inspect each tire and check the tire pressure with a tire gauge. Inflate all tires to the recommended inflation pressure. See **Inflating the Tires** (page 532).

INFLATING THE TIRES



WARNING: Under-inflation is the most common cause of tire failures and may result in severe tire cracking, tread separation or blowout, with unexpected loss of vehicle control and increased risk of injury. Under-inflation increases sidewall flexing and rolling resistance, resulting in heat buildup and internal damage to the tire. It also may result in unnecessary tire stress, irregular wear, loss of vehicle control and accidents. A tire can lose up to half of its air pressure and not appear to be flat!



WARNING: Do not use the tire pressure displayed in the information display as a tire pressure gauge. Failure to follow this instruction could result in personal injury or death.

Use the recommended cold inflation pressure for optimum tire performance and wear. Under-inflation or over-inflation may cause uneven treadwear patterns.

Inflate your tires to the recommended inflation pressure even if it is less than the maximum inflation pressure information found on the tire. You can find the tire label with the recommended tire inflation pressure next to the tire size on the B-Pillar or the edge of the driver door.

The recommended tire inflation pressure is also found on the Safety Compliance Certification Label, affixed to either the door hinge pillar, door-latch post, or the door edge that meets the door-latch on the B-pillar, or on the edge of the driver door.

Failure to follow the tire pressure recommendations can cause uneven treadwear patterns and adversely affect the way your vehicle handles.

Tire Care

INSPECTING THE TIRE FOR WEAR

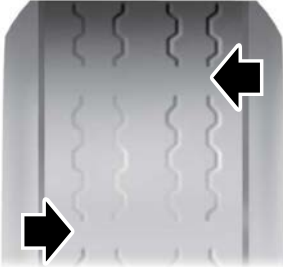

When the tread is worn down to one sixteenth of an inch (2 mm), tires must be replaced to help prevent your vehicle from skidding and hydroplaning. Built-in treadwear indicators, or wear bars, which look like narrow strips of smooth rubber across the tread will appear on the tire when the tread is worn down to one sixteenth of an inch (2 mm).

When the tire tread wears down to the same height as these wear bars, the tire is worn out and must be replaced.

The tires should also be balanced periodically. An unbalanced tire and wheel assembly may result in irregular tire wear.

Periodically inspect the tire treads for uneven or excessive wear and remove objects such as stones, nails or glass that may be wedged in the tread grooves.

INSPECTING THE TIRE FOR DAMAGE

Inspect the tire sidewalls for cracking, cuts, bruises and other signs of damage or excessive wear. If internal damage to the tire is suspected, have the tire dismantled and inspected in case it needs to be repaired or replaced. For your safety, tires that are damaged or show signs of excessive wear should not be used because they are more likely to blow out or fail.

Periodically inspect the tire treads and sidewalls for damage, such as bulges in the tread or sidewalls, cracks in the tread groove and separation in the tread or sidewall. If damage is observed or suspected, have the tire inspected by a tire professional.

Safety Practices



WARNING: If your vehicle is stuck in snow, mud or sand, do not rapidly spin the tires; spinning the tires can tear the tire and cause an explosion. A tire can explode in as little as three to five seconds.



WARNING: Do not spin the wheels at over 34 mph (55 km/h). The tires may fail and injure a passenger or bystander.

Tire Care

Highway Hazards

No matter how carefully you drive, there is always the possibility that you could eventually have a flat tire on the highway. Drive slowly to the closest safe area out of traffic. This could further damage the flat tire, but your safety is more important.

If you feel a sudden vibration or ride disturbance while driving, or you suspect your tire or vehicle has been damaged, immediately reduce your speed. Drive with caution until you can safely pull off the road. Stop and inspect the tires for damage. If a tire is under-inflated or damaged, deflate it, remove the wheel and replace it with your spare tire and wheel. If you cannot detect a cause, have the vehicle towed to the nearest repair facility or tire dealer to have the vehicle inspected.

Tire and Wheel Alignment

A bad jolt from hitting a curb or pothole can cause the front end of your vehicle to become misaligned or cause damage to your tires. If your vehicle seems to pull to one side when you are driving, the wheels could be out of alignment. Have an authorized dealer check the wheel alignment periodically.

Wheel misalignment in the front or the rear can cause uneven and rapid treadwear of your tires and should be corrected by an authorized dealer.

INSPECTING THE WHEEL VALVE STEMS

Check the valve stems for holes, cracks, or cuts that could permit air leakage.

TIRE ROTATION



WARNING: If the tire label shows different tire pressures for the front and rear tires and the vehicle has a tire pressure monitoring system, then you need to update the settings for the system sensors. Always perform the system reset procedure after tire rotation. If you do not reset the system, it may not provide a low tire pressure warning when necessary.

Rotating your tires at the recommended interval will help your tires wear more evenly, providing better tire performance and longer tire life.

Note: *If your tires show any uneven wear have the alignment checked by an authorized dealer before rotating tires.*

Tire Care

Note: *If you have a dissimilar spare wheel and tire assembly, it is intended for temporary use only and should not be used in a tire rotation.*

Note: *After having your tires rotated, inflation pressure must be checked and adjusted to the vehicle requirements.*

Tire Rotation Diagram

Follow the diagram indicating the correct tire locations for rotating the tires.

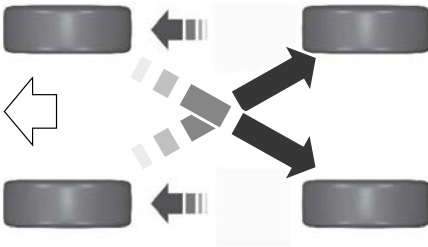

Tire Pressure Monitoring System

WHAT IS THE TIRE PRESSURE MONITORING SYSTEM



The tire pressure monitoring system measures the vehicle's tire pressures. A warning lamp illuminates if one or more tires are significantly underinflated or if there is a system malfunction.

TIRE PRESSURE MONITORING SYSTEM OVERVIEW



WARNING: If the tire pressure monitor sensor becomes damaged it may not function.



WARNING: Under-inflation is the most common cause of tire failures and may result in severe tire cracking, tread separation or blowout, with unexpected loss of vehicle control and increased risk of injury. Under-inflation increases sidewall flexing and rolling resistance, resulting in heat buildup and internal damage to the tire. It also may result in unnecessary tire stress, irregular wear, loss of vehicle control and accidents. A tire can lose up to half of its air pressure and not appear to be flat!



WARNING: To determine the required pressure(s) for your vehicle, see the Safety Compliance Certification Label (on the door hinge pillar, door-latch post or the door edge that meets the door-latch post, next to the driver seat) or the Tire Label on the B-Pillar or the edge of the driver door.

Each tire, including the spare (if provided), should be checked monthly when cold and inflated to the inflation pressure recommended by the vehicle manufacturer on the vehicle placard or tire inflation pressure label. (If your vehicle has tires of a different size than the size indicated on the vehicle placard or tire inflation pressure label, you should determine the proper tire inflation pressure for those tires).

As an added safety feature, your vehicle has been equipped with a Tire Pressure Monitoring System (TPMS) that illuminates a low tire pressure telltale when one or more of your tires is significantly under-inflated. Accordingly, when the low tire pressure telltale illuminates, you should stop and check your tires as soon as possible, and inflate them to the proper pressure. Driving on a significantly under-inflated tire causes the tire to overheat and can lead to tire failure. Under-inflation also reduces fuel efficiency and tire tread life, and may affect the vehicle's handling and stopping ability.

Please note that the TPMS is not a substitute for proper tire maintenance, and it is the driver's responsibility to maintain correct tire pressure, even if under-inflation has not reached the level to trigger illumination of the TPMS low tire pressure telltale.

Your vehicle has also been equipped with a TPMS malfunction indicator to indicate when the system is not operating properly. The TPMS malfunction indicator is combined with the low tire pressure telltale. When the system detects a malfunction, the telltale will flash for approximately one minute and then remain continuously illuminated. This sequence will continue upon subsequent vehicle start-ups as long as the malfunction exists.

Tire Pressure Monitoring System

When the malfunction indicator is illuminated, the system may not be able to detect or signal low tire pressure as intended. TPMS malfunctions may occur for a variety of reasons, including the installation of replacement or alternate tires or wheels on the vehicle that prevent the TPMS from functioning properly. Always check the TPMS malfunction telltale after replacing one or more tires or wheels on your vehicle to ensure that the replacement or alternate tires and wheels allow the TPMS to continue to function properly.



WARNING: Changes or modifications not expressly approved by the party responsible for compliance could void the user's authority to operate the equipment. The term "IC:" before the radio certification number only signifies that Industry Canada technical specifications were met.

This device complies with Part 15 of the FCC Rules and with License exempt RSS Standards of Industry Canada. Operation is subject to the following two conditions:

1. This device may not cause harmful interference, and
2. This device must accept any interference received, including interference that may cause undesired operation.

TIRE PRESSURE MONITORING SYSTEM PRECAUTIONS



WARNING: The tire pressure monitoring system is not a substitute for manually checking tire pressures. You should periodically check tire pressures using a pressure gauge. Failure to correctly maintain tire pressures could increase the risk of tire failure, loss of control, vehicle rollover and personal injury.



WARNING: Do not use the tire pressure displayed in the information display as a tire pressure gauge. Failure to follow this instruction could result in personal injury or death.

Note: *The use of tire sealants can damage the tire pressure monitoring system.*

TIRE PRESSURE MONITORING SYSTEM LIMITATIONS

When the outside temperature drops significantly, the tire pressure could decrease and activate the low tire pressure warning lamp.

The warning lamp could also illuminate when you use a spare wheel, or tire sealant from the inflator kit.

Note: *Regularly checking the vehicle tire pressures can reduce the possibility for the warning lamp to illuminate due to outside air temperature changes.*

Note: *After you inflate the tires to the recommended pressure it could take up to two minutes of driving over 20 mph (32 km/h) for the warning indicator to turn off.*

Tire Pressure Monitoring System

VIEWING THE TIRE PRESSURES



Using the information display arrow keys navigate to the truck info section where you can view the tire pressures.

RESETTING TIRE PRESSURE MONITORING SYSTEM

Tire Pressure Monitoring System Reset Procedure



WARNING: To determine the required pressure(s) for your vehicle, see the Safety Compliance Certification Label (on the door hinge pillar, door-latch post or the door edge that meets the door-latch post, next to the driver seat) or the Tire Label on the B-Pillar or the edge of the driver door.

You must reset the tire pressure monitoring system after each tire rotation on vehicles that require different recommended tire pressures in the front tires as compared to the rear tires.

Note: To reduce the chances of interference from another vehicle, perform the system reset procedure at least three feet, one meter, away from another vehicle undergoing the system reset procedure at the same time.

Note: Do not wait more than two minutes between resetting each tire sensor or the system can time-out and you need to repeat the entire procedure on all four wheels.

1. Drive the vehicle above 20 mph (32 km/h) for at least two minutes, then park in a safe location where you can easily get to all four tires and have access to an air pump.
2. Switch the ignition off.
3. Switch the ignition on but do not start the engine.
4. Switch the hazard flashers on then off three times.

Note: You must accomplish this within 10 seconds. If you successfully enter the reset mode, the horn sounds once, the system indicator flashes and a message shows in the information display.

Tire Pressure Monitoring System

Note: If the system does not enter reset mode, try again starting at Step 2. If after repeated attempts to enter the reset mode, the horn does not sound, the system indicator does not flash and no message shows in the information display, contact your authorized dealer.

5. Remove the valve cap from the valve stem on the left front tire. Decrease the air pressure until the horn sounds.

Note: The single horn tone confirms that the sensor identification code has been learned by the module for this position. If the horn sounds twice, the reset procedure was unsuccessful, and you must repeat it.

6. Remove the valve cap from the valve stem on the right front tire. Decrease the air pressure until the horn sounds.
7. Repeat the previous step on the right rear tire and then on the left rear tire.
8. Switch the ignition off.

Note: If the horn sounds twice again after switching the ignition off, and repeating the procedure, contact your authorized dealer and have your vehicle checked as soon as possible.

9. Set all four tires to the recommended air pressure as indicated on the Safety Compliance Certification Label.

Trailer Tire Pressure Monitoring System (if Equipped)

Note: Additional equipment may be required for your vehicle to support trailer tire pressure and temperature monitoring. See your authorized dealer for more information.

Note: The trailer tire pressure monitoring system is not a substitute for proper tire maintenance. It is your responsibility to maintain correct tire pressures at all times.

Note: If a trailer tire is repaired, replaced or broken down for service, the screw and valve on the trailer tire pressure sensor should be replaced. See your authorized dealer for details.



The trailer tire pressure monitoring system is an added safety feature that allows you to view your trailer tire pressures and temperatures through the information display. See **Tire Pressure Monitoring System – Information Messages** (page 542). Tire

Tire Pressure Monitoring System

pressure sensors are mounted into each tire on your trailer. The sensors send a message to your vehicle indicating the current trailer tire pressure and temperature.

If the trailer tire pressure monitoring system detects that a tire is low, a warning message appears in the information display. The trailer tire information screen in the information display highlights the tire with a low pressure.

If the trailer tire pressure monitoring system detects that a tire temperature is over temp, a warning message appears in the Information display. The trailer tire information screen in the information display highlights the tire with a high temperature.

The main function of the trailer tire pressure monitoring system is to warn you when your trailer tires need air or if the tires are experiencing high temperatures. It can also warn you in the event the system is no longer capable of functioning as intended. See

Tire Pressure Monitoring System – Information Messages (page 542).

When a Temporary Spare or New Tire is Installed

If you have replaced a trailer tire with a new or spare tire, a warning message appears and pressure readings are no longer displayed for that tire.

To restore the full function of the trailer tire pressure monitoring system:

- Have the damaged wheel and tire assembly repaired and remounted to your trailer.
- Install the trailer tire pressure monitoring sensor into the new wheel and tire assembly.
- Perform the trailer tire pressure monitoring system reset procedure.

Trailer Tire Pressure Monitoring System Reset Procedure

Note: *You need to perform the tire pressure monitoring system reset procedure after each tire rotation, or when a new trailer tire pressure sensor is installed into a trailer tire.*

The trailer tire pressure monitoring system can be reset through the menu in the information display. See **Tire Pressure Monitoring System – Information Messages** (page 542). Performing the trailer setup process also resets the trailer tire pressure monitoring system.

Tire Pressure Monitoring System

TIRE PRESSURE MONITORING SYSTEM – TROUBLESHOOTING



The low tire pressure warning lamp has combined functions, as it warns you when your tires need air, and when the system is no longer capable of functioning as intended.

TIRE PRESSURE MONITORING SYSTEM – WARNING LAMPS

| Warning Lamp | Possible Cause | Action Required |
|---|--|---|
| Solid warning lamp | One or more tires are significantly under inflated | After inflating your tires to the manufacturer's recommended pressure as shown on the tire label, on the edge of driver door or the B-pillar, drive your vehicle for at least two minutes over 20 mph (32 km/h) before the light turns off. |
| Solid warning lamp or flashing warning lamp | Temporary spare wheel in use | Repair the damaged road wheel and tire and refit it to your vehicle to restore operation of the system. |
| | Tire pressure monitoring system malfunction | If the tires are inflated to the recommended tire pressures and the temporary spare wheel is not in use, the system detected a fault that requires service. Have your vehicle checked as soon as possible. |

Tire Pressure Monitoring System

TIRE PRESSURE MONITORING SYSTEM – INFORMATION MESSAGES

| Message | Action |
|-----------------------------|---|
| Tire Pressure Low | After inflating your tires to the manufacturer's recommended pressure as shown on the Tire Label, on the edge of the driver door or the B-Pillar, drive your vehicle for at least two minutes over 20 mph (32 km/h) before the light turns off. |
| Tire Pressure Monitor Fault | The system has detected a fault that requires service. Have your vehicle checked as soon as possible. |
| Tire Pressure Sensor Fault | The system has detected a fault that requires service or a spare tire is in use. Have your vehicle checked as soon as possible. |

Trailer Tire Pressure Monitoring System

| Message | Action |
|---|--|
| Trailer Tire Low Specified: | One or more tires on your trailer is below the specified tire pressure. |
| Trailer Tire Over Temperature | Displays when one or more tires on your trailer is above the recommended temperature. |
| Trailer Tire Pressure Sensor Fault | A trailer tire pressure sensor is malfunctioning. If the warning stays on or continues to come on, contact an authorized dealer as soon as possible. |
| Trailer Tire Pressure Monitor Fault | The trailer tire pressure monitoring system is malfunctioning. If the warning stays on or continues to come on, contact an authorized dealer. |
| Trailer Tire Pressure Monitor Capability Not Detected | The system cannot detect the trailer tire pressure monitoring system. |
| Trailer Tire Pressure Indication Not Setup See Manual | The trailer tire pressure monitoring system is not setup. See Tire Pressure Monitoring System (page 536). |

Changing a Road Wheel

CHANGING A FLAT TIRE

If you get a flat tire when driving, do not apply the brake heavily. Instead, gradually decrease your speed. Hold the steering wheel firmly and slowly move to a safe place on the side of the road.

Have a flat serviced by an authorized dealer to prevent damage to the system sensors. See **Tire Pressure Monitoring System Precautions** (page 537). Replace the spare tire with a road tire as soon as possible. When repairing or replacing the flat tire, have the authorized dealer inspect the system sensor for damage.

Note: *The use of tire sealant could damage your tire pressure monitoring system. Only use in roadside emergencies.*

Note: *The tire pressure monitoring system indicator light illuminates when the spare tire is in use. To restore the full function of the monitoring system, you must mount all road wheels that come with tire pressure monitoring sensors on this vehicle.*

Dissimilar Spare Wheel and Tire Assembly Information



WARNING: Failure to follow these guidelines could result in an increased risk of loss of vehicle control, injury or death.

If you have a dissimilar spare wheel and tire, the intent of the spare wheel is for temporary use only. This means that if you need to use it, replace it as soon as possible with a road wheel and tire assembly that is the same size and type as the road tires and wheels originally provided by Ford.

We define a dissimilar spare wheel and tire assembly as a spare wheel and tire assembly that is different in brand, size or appearance from the road tires and wheels.

Full-size dissimilar spare

When driving with the full-size dissimilar spare wheel and tire assembly, do not:

- Exceed 70 mph (113 km/h).
- Use more than one dissimilar spare wheel and tire assembly at a time.
- Use snow chains on the end of the vehicle with the dissimilar spare wheel and tire assembly.

Engage any four-wheel drive mode. See **Four-Wheel Drive Limitations** (page 270).

The usage of a full-size dissimilar spare wheel and tire assembly can lead to impairment of the following:

- Handling, stability and braking performance.
- Comfort and noise.
- Ground clearance and parking at curbs.
- Winter weather driving capability.
- Wet weather driving capability.
- Four-wheel drive capability.

When driving with the full-size dissimilar spare wheel and tire assembly, give additional caution to:

- Towing a trailer.
- Driving vehicles that come with a camper body.
- Driving vehicles with a load on the cargo rack.

Drive cautiously when using a full-size dissimilar spare wheel and tire assembly and seek service as soon as possible.

Changing a Road Wheel

Tire Change Procedure

 **WARNING:** To help prevent your vehicle from moving when changing a wheel, shift the transmission into park (P), set the parking brake and use an appropriate block or wheel chock to secure the wheel diagonally opposite to the wheel being changed. For example, when changing the front left wheel, place an appropriate block or wheel chock on the right rear wheel.

 **WARNING:** The jack supplied with this vehicle is only intended for changing a flat tire in an emergency. Do not attempt to do any other work on your vehicle when it is supported by the jack, as your vehicle could slip off the jack. Failure to follow this instruction could result in personal injury or death.

 **WARNING:** Do not attempt to change a tire on the side of the vehicle close to moving traffic. Pull far enough off the road to not obstruct the flow of traffic and avoid the danger of being hit when operating the jack or changing the wheel.

 **WARNING:** Only use the jack provided as original equipment with your vehicle.

 **WARNING:** Do not get under a vehicle that is supported by a jack.

 **WARNING:** The jack supplied with this vehicle is only intended for changing a flat tire in an emergency. Do not attempt to do any other work on your vehicle when it is supported by the jack, as your vehicle could slip off the jack. Failure to follow this instruction could result in personal injury or death.

 **WARNING:** The jack should be used on level firm ground wherever possible.

 **WARNING:** Never place anything between the vehicle jack and the ground.

 **WARNING:** Never place anything between the vehicle jack and your vehicle.

 **WARNING:** It is recommended that the wheels of the vehicle be chocked, and that no person should remain in a vehicle that is being jacked.

 **WARNING:** Switch off the running boards before jacking or placing any object under your vehicle. Never place your hand between the extended running board and your vehicle. A moving running board may cause injury.

Park on a level surface, activate the hazard flashers and set the parking brake. Then, place the transmission in park (P) and turn the engine off.

Note: Only use the spare tire carrier to stow the tire and wheel combination provided with your vehicle. Other tire and wheel combinations can cause the tire carrier to fail.

Note: Do not use impact tools or power tools operating at over 200 RPM on the spare tire carrier, this could cause a winch malfunction and prevent a secure fit.

Note: Passengers should not remain in the vehicle when the vehicle is being jacked.

Removing the Vehicle Jack and Tool Bag

The vehicle jack and tool bag are on the rear passenger side of your vehicle, behind the passenger seat.

Changing a Road Wheel

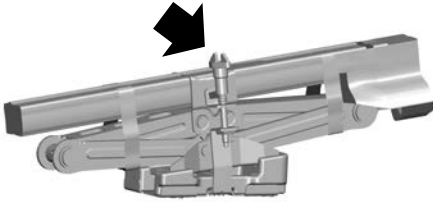

1. Turn the wing bolt on the jack bracket counterclockwise to release the jack and tool bag from the jack bracket.

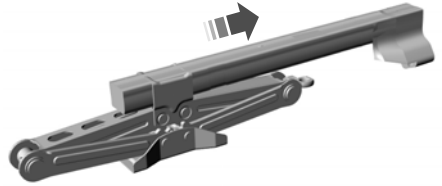

4. Slide the jack tool bag through the jack load rest to remove for access to the jack tools.
5. Remove the tools from the tool bag.

Note: *Your jack does not require maintenance or additional lubrication over the service life of your vehicle.*

Removing the Spare Tire

The spare tire is under the vehicle, just forward of the rear bumper.

Note: *Remove the hook end from the assembled jack handle before continuing.*

1. Use your key to remove the lock cylinder from the access hole of the bumper to allow access to the guide tube.

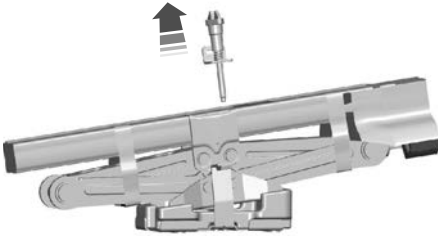

2. Remove the jack and tool bag from the jack bracket.

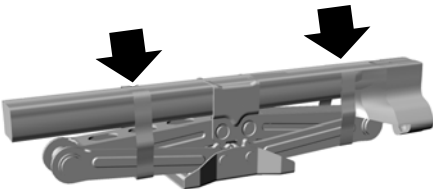

3. Release the jack tool bag straps.

Changing a Road Wheel

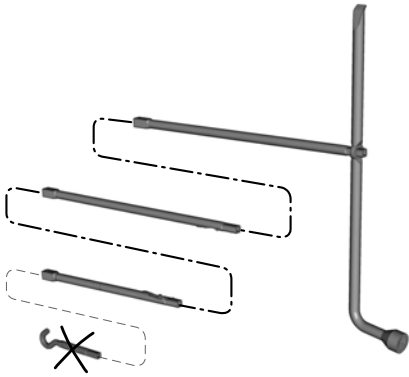

2. Assemble the jack handle as shown in the illustration.

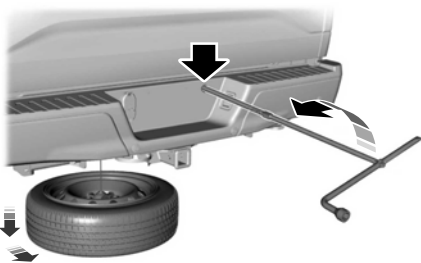

3. Fully insert the jack handle through the bumper hole and into the guide tube through the access hole in the rear bumper. Turn the handle counterclockwise until you lower the tire to the ground and the cable is slightly slack to allow you to slide the tire rearward from under your vehicle.
4. Remove the retainer from the center of the wheel.

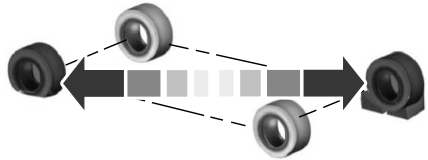

5. Block both the front and rear of the wheel diagonally opposite the flat tire. For example, if the left front tire is flat, block the right rear wheel.
6. Obtain the spare tire and vehicle jack from their storage locations.
7. Loosen each wheel nut on the affected flat tire one-half turn counterclockwise, but do not remove them.

Jacking the Vehicle

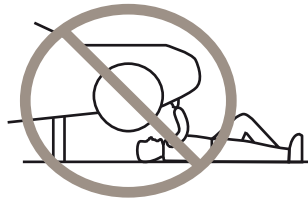

Changing a Road Wheel

Front Jacking Points

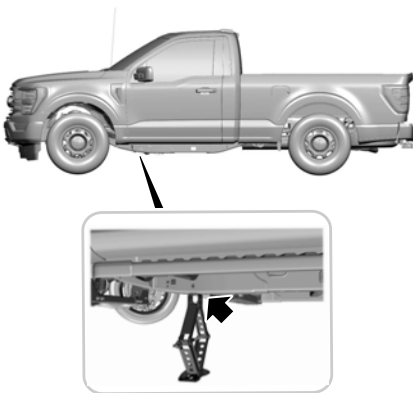

Note: Use the frame rail as the front jacking location point, not the control arm. There is an arrow marked on the frame rail.

Rear Jacking Points

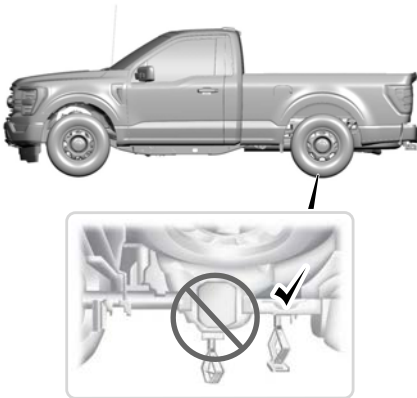

Note: Jack at the specified locations to avoid damage to the vehicle.

1. Place the vehicle jack at the jacking point next to the tire you are changing.
2. Reassemble the jack handle, including the S-hook, to the lug wrench. Insert the S-hook into the eyelet of the jack and turn the jack handle clockwise until the wheel is completely off the ground.
3. Remove the wheel nuts with the lug wrench.
4. Replace the flat tire with the spare tire, making sure the valve stem is facing outward. Reinstall the wheel nuts until the wheel is snug against the hub. Do not fully tighten the wheel nuts until you lower the wheel.
5. Lower the wheel by turning the jack handle counterclockwise.
6. Remove the vehicle jack and fully tighten the wheel nuts in the order shown.
7. Stow the flat tire.
8. Stow the vehicle jack and lug wrench. Make sure the jack is securely fastened before you drive.
9. Unblock the wheels.

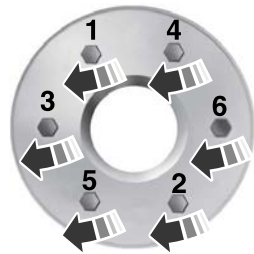

Stowing the Flat or Spare Tire

Note: Failure to follow the spare tire stowage instructions could result in failure of the cable or loss of the spare tire.

Changing a Road Wheel

1. Lay the tire on the ground with the valve stem facing up.
2. Slide the wheel partially under the vehicle and install the retainer through the wheel center. Pull on the cable to align the components at the end of the cable.
3. Turn the jack handle clockwise until you raise the tire to its stowed position underneath the vehicle. The effort to turn the jack handle increases significantly and the spare tire carrier ratchets or slips when you raise the tire to the maximum tightness. Tighten to the point where the ratchet or slip occurs a minimum of three times, as indicated by an audible click each time. The spare tire carrier does not allow you to overtighten. If the spare tire carrier ratchets or slips with little effort, have your vehicle checked as soon as possible.
4. Check that the tire lies flat against the frame and you properly tighten it. Try to push or pull, then turn the tire to be sure it does not move. Loosen and retighten, if necessary. Failure to properly stow the spare tire could result in failure of the winch cable and loss of the tire.
5. Repeat this tightness check procedure when servicing the spare tire pressure, every six months, as per your scheduled maintenance information, or at any time that the spare tire gets disturbed through service of other components.
6. If removed, install the spare tire lock into the bumper drive tube with the spare tire lock key and jack handle.

Stowing the Vehicle Jack and Tool Bag

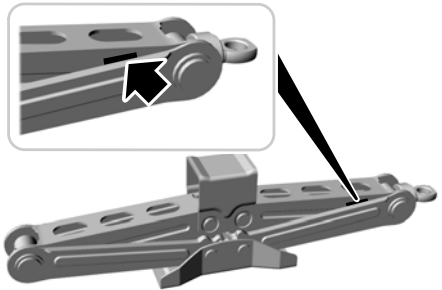

1. Turn the lead screw eyelet to adjust the jack up or down until the stowage markings on the upper channel align with the lower channel.

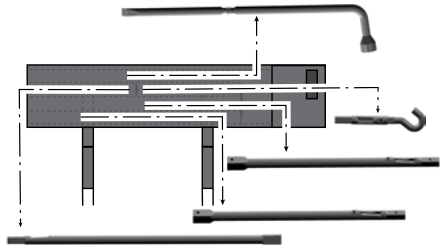

2. Place the tools inside of the tool bag.

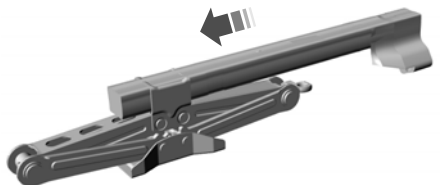

Changing a Road Wheel

3. Install the tool bag through the vehicle jack load rest.

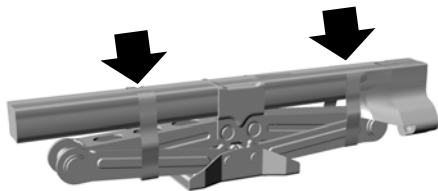

4. Secure the jack tool bag straps around the vehicle jack.

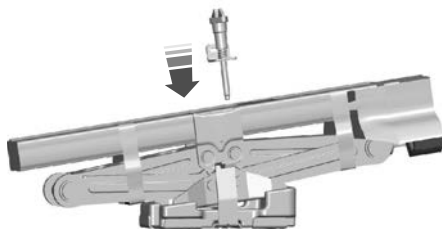

5. Place the jack and tool bag back onto the jack bracket.

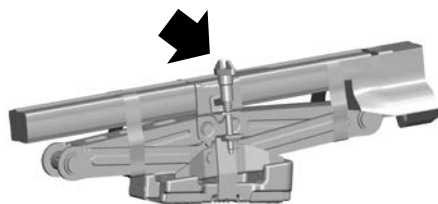

6. Turn the wing bolt on the jack bracket clockwise until you secure the jack and tools to the jack bracket.

CHANGING A FLAT TIRE - RAPTOR/TREMOR

If you get a flat tire when driving, do not apply the brake heavily. Instead, gradually decrease your speed. Hold the steering wheel firmly and slowly move to a safe place on the side of the road.

Have a flat serviced by an authorized dealer to prevent damage to the system sensors. See **Tire Pressure Monitoring System Precautions** (page 537). Replace the spare tire with a road tire as soon as possible. When repairing or replacing the flat tire, have the authorized dealer inspect the system sensor for damage.

Note: The use of tire sealant could damage your tire pressure monitoring system. Only use in roadside emergencies.

Note: The tire pressure monitoring system indicator light illuminates when the spare tire is in use. To restore the full function of the monitoring system, you must mount all road wheels that come with tire pressure monitoring sensors on this vehicle.

Dissimilar Spare Wheel and Tire Assembly Information

 **WARNING:** Failure to follow these guidelines could result in an increased risk of loss of vehicle control, injury or death.

Changing a Road Wheel

If you have a dissimilar spare wheel and tire, the intent of the spare wheel is for temporary use only. This means that if you need to use it, replace it as soon as possible with a road wheel and tire assembly that is the same size and type as the road tires and wheels originally provided by Ford.

We define a dissimilar spare wheel and tire assembly as a spare wheel and tire assembly that is different in brand, size or appearance from the road tires and wheels.

Full-size dissimilar spare

When driving with the full-size dissimilar spare wheel and tire assembly, do not:

- Exceed 70 mph (113 km/h).
- Use more than one dissimilar spare wheel and tire assembly at a time.
- Use snow chains on the end of the vehicle with the dissimilar spare wheel and tire assembly.

Engage any four-wheel drive mode. See **Four-Wheel Drive Limitations** (page 270).

The usage of a full-size dissimilar spare wheel and tire assembly can lead to impairment of the following:

- Handling, stability and braking performance.
- Comfort and noise.
- Ground clearance and parking at curbs.
- Winter weather driving capability.
- Wet weather driving capability.
- Four-wheel drive capability.

When driving with the full-size dissimilar spare wheel and tire assembly, give additional caution to:

- Towing a trailer.
- Driving vehicles that come with a camper body.
- Driving vehicles with a load on the cargo rack.

Drive cautiously when using a full-size dissimilar spare wheel and tire assembly and seek service as soon as possible.

Tire Change Procedure



WARNING: To help prevent your vehicle from moving when changing a wheel, shift the transmission into park (P), set the parking brake and use an appropriate block or wheel chock to secure the wheel diagonally opposite to the wheel being changed. For example, when changing the front left wheel, place an appropriate block or wheel chock on the right rear wheel.



WARNING: The jack supplied with this vehicle is only intended for changing a flat tire in an emergency. Do not attempt to do any other work on your vehicle when it is supported by the jack, as your vehicle could slip off the jack. Failure to follow this instruction could result in personal injury or death.



WARNING: Do not attempt to change a tire on the side of the vehicle close to moving traffic. Pull far enough off the road to not obstruct the flow of traffic and avoid the danger of being hit when operating the jack or changing the wheel.



WARNING: Only use the jack provided as original equipment with your vehicle.

Changing a Road Wheel

WARNING: Do not get under a vehicle that is supported by a jack.

WARNING: The jack supplied with this vehicle is only intended for changing a flat tire in an emergency. Do not attempt to do any other work on your vehicle when it is supported by the jack, as your vehicle could slip off the jack. Failure to follow this instruction could result in personal injury or death.

WARNING: The jack should be used on level firm ground wherever possible.

WARNING: Never place anything between the vehicle jack and the ground.

WARNING: Never place anything between the vehicle jack and your vehicle.

WARNING: It is recommended that the wheels of the vehicle be chocked, and that no person should remain in a vehicle that is being jacked.

WARNING: Switch off the running boards before jacking or placing any object under your vehicle. Never place your hand between the extended running board and your vehicle. A moving running board may cause injury.

Park on a level surface, activate the hazard flashers and set the parking brake. Then, place the transmission in park (P) and turn the engine off.

Note: Only use the spare tire carrier to stow the tire and wheel combination provided with your vehicle. Other tire and wheel combinations can cause the tire carrier to fail.

Note: Do not use impact tools or power tools operating at over 200 RPM on the spare tire carrier, this could cause a winch malfunction and prevent a secure fit.

Note: Passengers should not remain in the vehicle when the vehicle is being jacked.

Removing the Vehicle Jack and Tool Bag

The vehicle jack and tool bag are on the rear passenger side of your vehicle, behind the passenger seat.

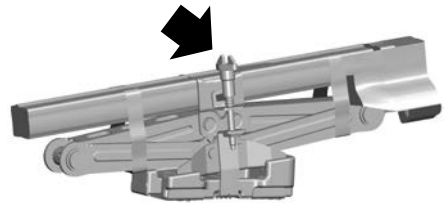

1. Turn the wing bolt on the jack bracket counterclockwise to release the jack and tool bag from the jack bracket.

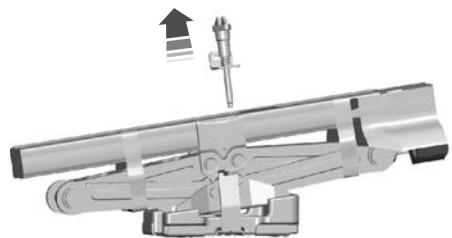

2. Remove the jack and tool bag from the jack bracket.

Changing a Road Wheel

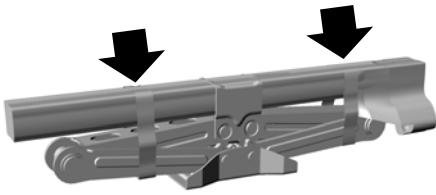

3. Release the jack tool bag straps.

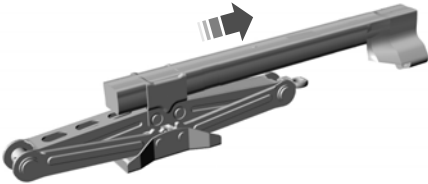

4. Slide the jack tool bag through the jack load rest to remove for access to the jack tools.
5. Remove the tools from the tool bag.

Note: Your jack does not require maintenance or additional lubrication over the service life of your vehicle.

Removing the Spare Tire

The spare tire is under the vehicle, just forward of the rear bumper.

Note: Remove the hook end from the assembled jack handle before continuing.

1. Use your key to remove the lock cylinder from the access hole of the bumper to allow access to the guide tube.

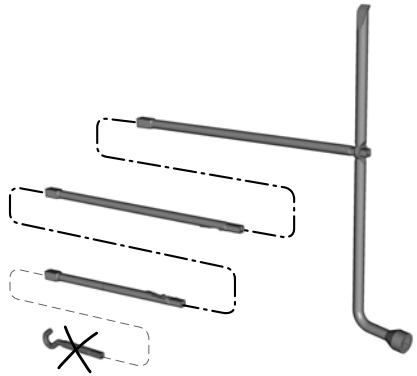

2. Assemble the jack handle as shown in the illustration.

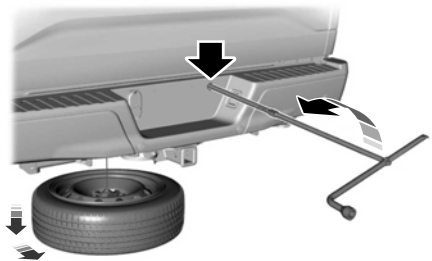

3. Fully insert the jack handle through the bumper hole and into the guide tube through the access hole in the rear bumper. Turn the handle counterclockwise until you lower the tire to the ground and the cable is slightly slack to allow you to slide the tire rearward from under your vehicle.
4. Remove the retainer from the center of the wheel.

Changing a Road Wheel

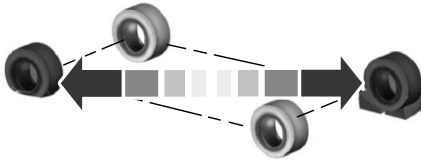

5. Block both the front and rear of the wheel diagonally opposite the flat tire. For example, if the left front tire is flat, block the right rear wheel.
6. Obtain the spare tire and vehicle jack from their storage locations.
7. Loosen each wheel nut on the affected flat tire one-half turn counterclockwise, but do not remove them.

Jacking the Vehicle

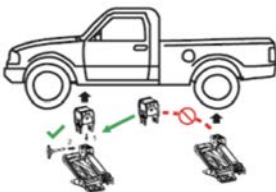
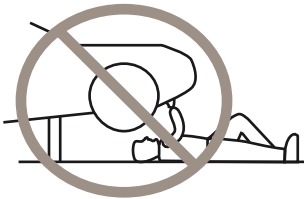

ML3V-17K033-AA

Front Jacking Points

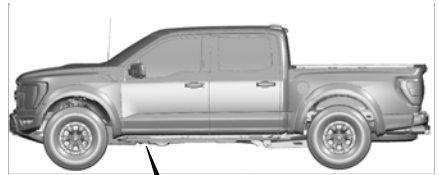

Note: Use the frame rail as the front jacking location point, not the control arm. There is an arrow marked on the frame rail.

Rear Jacking Points



Note: Jack at the specified locations to avoid damage to the vehicle.

Changing a Road Wheel

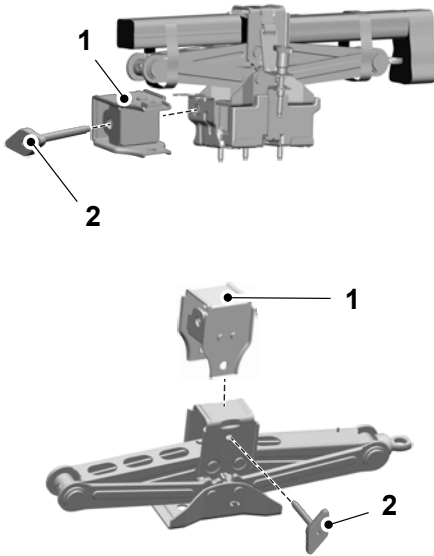

| | |
|----|-----------------|
| 1. | Extension Block |
| 2. | Wing bolt |

1. Place the vehicle jack at the jacking point next to the tire you are changing.
2. When jacking the vehicle to service a front wheel/tire, remove the wing bolt holding the extension block to the jack stowage bracket and reuse wing bolt to attach extension block to jacking surface.

Note: *If servicing a rear tire position, the extension block is not needed.*

3. Reassemble the jack handle, including the S-hook, to the lug wrench. Insert the S-hook into the eyelet of the jack and turn the jack handle clockwise until the wheel is completely off the ground.

4. Remove the wheel nuts with the lug wrench.
5. Replace the flat tire with the spare tire, making sure the valve stem is facing outward. Reinstall the wheel nuts until the wheel is snug against the hub. Do not fully tighten the wheel nuts until you lower the wheel.
6. Lower the wheel by turning the jack handle counterclockwise.
7. Remove the vehicle jack and fully tighten the wheel nuts in the order shown.
8. Stow the flat tire.
9. Stow the vehicle jack and lug wrench. Make sure the jack is securely fastened before you drive.
10. Unblock the wheels.

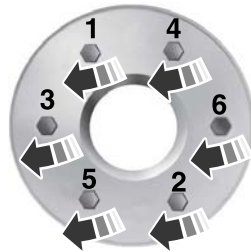

Stowing the Flat or Spare Tire

Note: *Failure to follow the spare tire stowage instructions could result in failure of the cable or loss of the spare tire.*

1. Lay the tire on the ground with the valve stem facing up.
2. Slide the wheel partially under the vehicle and install the retainer through the wheel center. Pull on the cable to align the components at the end of the cable.

Changing a Road Wheel

3. Turn the jack handle clockwise until you raise the tire to its stowed position underneath the vehicle. The effort to turn the jack handle increases significantly and the spare tire carrier ratchets or slips when you raise the tire to the maximum tightness. Tighten to the point where the ratchet or slip occurs a minimum of three times, as indicated by an audible click each time. The spare tire carrier does not allow you to overtighten. If the spare tire carrier ratchets or slips with little effort, have your vehicle checked as soon as possible.
4. Check that the tire lies flat against the frame and you properly tighten it. Try to push or pull, then turn the tire to be sure it does not move. Loosen and retighten, if necessary. Failure to properly stow the spare tire could result in failure of the winch cable and loss of the tire.
5. Repeat this tightness check procedure when servicing the spare tire pressure, every six months, as per your scheduled maintenance information, or at any time that the spare tire gets disturbed through service of other components.
6. If removed, install the spare tire lock into the bumper drive tube with the spare tire lock key and jack handle.

Stowing the Vehicle Jack and Tool Bag

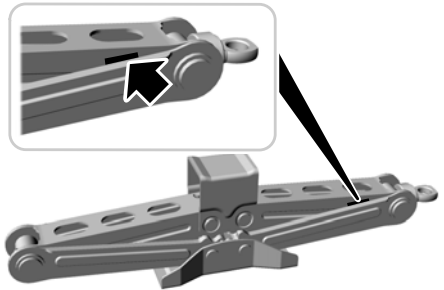

1. Turn the lead screw eyelet to adjust the jack up or down until the stowage markings on the upper channel align with the lower channel.

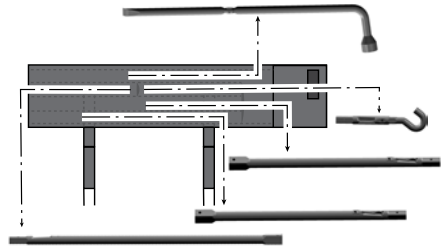

2. Place the tools inside of the tool bag.

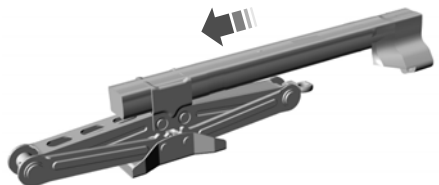

Changing a Road Wheel

3. Install the tool bag through the vehicle jack load rest.
4. Restow the extension block and wing bolt to the jack bracket.

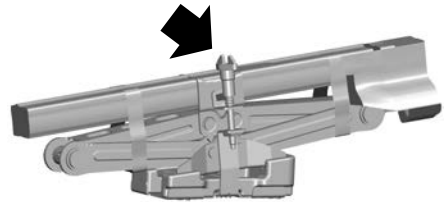
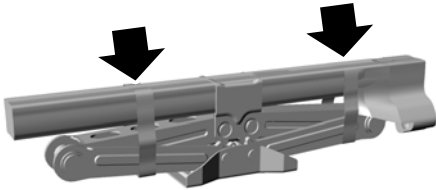

5. Secure the jack tool bag straps around the vehicle jack.

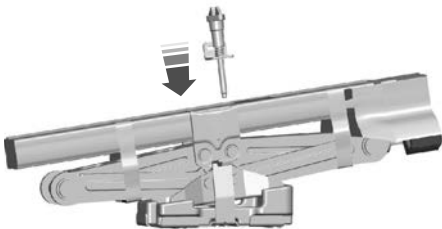

6. Place the jack and tool bag back onto the jack bracket.

7. Turn the wing bolt on the jack bracket clockwise until you secure the jack and tools to the jack bracket.

WHEEL NUTS



WARNING: When you install a wheel, always remove any corrosion, dirt or foreign materials present on the mounting surfaces of the wheel or the surface of the wheel hub, brake drum or brake disc that contacts the wheel. Make sure to secure any fasteners that attach the rotor to the hub so they do not interfere with the mounting surfaces of the wheel. Installing wheels without correct metal-to-metal contact at the wheel mounting surfaces can cause the wheel nuts to loosen and the wheel to come off while your vehicle is in motion, resulting in loss of vehicle control, personal injury or death.

| Bolt Size | lb.ft (Nm) ¹ |
|-----------|-------------------------|
| M14 x 1.5 | 150 lb.ft (204 Nm) |

¹Torque specifications are for nut and bolt threads free of dirt and rust. Use only our recommended replacement wheel nuts and or wheel bolts.

Changing a Road Wheel

Retighten the wheel nuts to the specified torque within 100 mi (160 km) after any wheel disturbance, such as tire rotation, changing a flat tire or wheel removal.



A Hub pilot bore.

Inspect the wheel pilot hole and mounting surface prior to installation. Remove any visible corrosion or loose particles.

Capacities and Specifications

ENGINE SPECIFICATIONS - 2.7L ECOBOOST™

| Engine | Specification |
|--------------------|--|
| Compression ratio. | 10.0:1 |
| Displacement. | 165 in ³ (2,700 cm ³) |
| Firing order. | 1-4-2-5-3-6 |
| Ignition system. | Coil on plug |
| Required fuel. | Minimum 87 octane |
| Spark plug gap. | 0.028 in (0.7 mm) - 0.031 in (0.8 mm) |

Capacities and Specifications

ENGINE SPECIFICATIONS - 3.3L

| Engine | Specification |
|--------------------|--|
| Compression ratio. | 12:1 |
| Displacement. | 203.8 in ³ (3,340 cm ³) |
| Firing order. | 1-4-2-5-3-6 |
| Ignition system. | Coil on plug |
| Required fuel. | Minimum 87 octane |
| Spark plug gap. | 0.049 in (1.25 mm) - 0.053 in (1.35 mm) |

Capacities and Specifications

ENGINE SPECIFICATIONS - 3.5L ECOBOOST™

| Engine | Specification |
|--------------------|--|
| Compression ratio. | 10.5:1 |
| Displacement. | 213.4 in ³ (3,497 cm ³) |
| Firing order. | 1-4-2-5-3-6 |
| Ignition system. | Coil on plug |
| Required fuel. | Minimum 87 octane |
| Spark plug gap. | 0.028 in (0.7 mm) - 0.031 in (0.8 mm) |

Capacities and Specifications

ENGINE SPECIFICATIONS - 3.5L, HYBRID ELECTRIC VEHICLE (HEV)

| Engine | Specification |
|--------------------|--|
| Compression ratio. | 10.5:1 |
| Displacement. | 213.4 in ³ (3,497 cm ³) |
| Firing order. | 1-4-2-5-3-6 |
| Ignition system. | Coil on plug |
| Required fuel. | Minimum 87 octane |
| Spark plug gap. | 0.028 in (0.7 mm) - 0.031 in (0.8 mm) |

Capacities and Specifications

ENGINE SPECIFICATIONS - 5.0L

| Engine | Specification |
|--------------------|--|
| Compression ratio. | 12:1 |
| Displacement. | 307 in ³ (5,038 cm ³) |
| Firing order. | 1-3-7-2-6-5-4-8 |
| Ignition system. | Coil on plug, coil near plug |
| Required fuel. | Minimum 87 octane |
| Spark plug gap. | 0.039 in (1 mm) - 0.043 in (1.1 mm) |

Capacities and Specifications

MOTORCRAFT PARTS - 2.7L ECOBOOST™

| Component | Motorcraft Part Number |
|---------------------------------|-------------------------------|
| Air filter element. | FA-1883 |
| Battery. | BAGM-48H6-760 |
| Cabin air filter. | FP-92 |
| Engine oil filter. ¹ | FL-2062-A |
| Spark plug. | SP-578 |
| Windshield wiper blade. | WW-2208 |

¹ If a Motorcraft oil filter is not available, use an oil filter that meets industry performance specification SAE/USCAR-36.

We recommend Motorcraft parts that are available at your authorized dealer or at www.fordparts.com. We engineer these parts for your vehicle to meet or exceed our specifications. Use of other parts could impact vehicle performance, emissions and durability. Your warranty could be void for any damage related to use of other parts.

Capacities and Specifications

MOTORCRAFT PARTS - 3.3L

| Component | Motorcraft Part Number |
|---------------------------------|-------------------------------|
| Air filter element. | FA-1883 |
| Battery. | BAGM-48H6-760 |
| Cabin air filter. | FP-92 |
| Engine oil filter. ¹ | FL-500-S |
| Spark plug. | SP-520 |
| Windshield wiper blade. | WW-2208 |

¹ If a Motorcraft oil filter is not available, use an oil filter that meets industry performance specification SAE/USCAR-36.

We recommend Motorcraft parts that are available at your authorized dealer or at www.fordparts.com. We engineer these parts for your vehicle to meet or exceed our specifications. Use of other parts could impact vehicle performance, emissions and durability. Your warranty could be void for any damage related to use of other parts.

Capacities and Specifications

MOTORCRAFT PARTS - 3.5L ECOBOOST™

| Component | Motorcraft Part Number |
|---------------------------------|-------------------------------|
| Air filter element. | FA-1883 |
| Battery-standard. | BAGM-48H6-760 |
| Battery-optional. | BAGM-94RH7-800 |
| Cabin air filter. | FP-92 |
| Engine oil filter. ¹ | FL-500-S |
| Spark plug. | SP-596 |
| Windshield wiper blade. | WW-2208 |

¹ If a Motorcraft oil filter is not available, use an oil filter that meets industry performance specification SAE/USCAR-36.

We recommend Motorcraft parts that are available at your authorized dealer or at www.fordparts.com. We engineer these parts for your vehicle to meet or exceed our specifications. Use of other parts could impact vehicle performance, emissions and durability. Your warranty could be void for any damage related to use of other parts.

Capacities and Specifications

MOTORCRAFT PARTS - 3.5L, HYBRID ELECTRIC VEHICLE (HEV)

| Component | Motorcraft Part Number |
|---------------------------------|------------------------|
| Air filter element. | FA-1883 |
| Battery-standard. | BAGM-94RH7-800 |
| Cabin air filter. | FP-92 |
| Engine oil filter. ¹ | FL-500-S |
| Spark plug. | SP-596 |
| Windshield wiper blade. | WW-2208 |

¹ If a Motorcraft oil filter is not available, use an oil filter that meets industry performance specification SAE/USCAR-36.

We recommend Motorcraft parts that are available at your authorized dealer or at www.fordparts.com. We engineer these parts for your vehicle to meet or exceed our specifications. Use of other parts could impact vehicle performance, emissions and durability. Your warranty could be void for any damage related to use of other parts.

Capacities and Specifications

MOTORCRAFT PARTS - 5.0L

| Component | Motorcraft Part Number |
|---------------------------------|-------------------------------|
| Air filter element. | FA-1883 |
| Battery-standard. | BAGM-48H6-760 |
| Battery-optional. | BAGM-94RH7-800 |
| Cabin air filter. | FP-92 |
| Engine oil filter. ¹ | FL-500-S |
| Spark plug. | SP-588 |
| Windshield wiper blade. | WW-2208 |

¹If a Motorcraft oil filter is not available, use an oil filter that meets industry performance specification SAE/USCAR-36.

We recommend Motorcraft parts that are available at your authorized dealer or at www.fordparts.com. We engineer these parts for your vehicle to meet or exceed our specifications. Use of other parts could impact vehicle performance, emissions and durability. Your warranty could be void for any damage related to use of other parts.

Capacities and Specifications

MOTORCRAFT PARTS - RAPTOR

| Component | Motorcraft Part Number |
|---------------------------------|-------------------------------|
| Air filter element. | FA-1883 |
| Battery. | BAGM-94RH7-800 |
| Cabin air filter. | FP-92 |
| Engine oil filter. ¹ | FL-500-S |
| Spark plug. | SP-596 |
| Windshield wiper blade. | WW-2208 |

¹ If a Motorcraft oil filter is not available, use an oil filter that meets industry performance specification SAE/USCAR-36.

We recommend Motorcraft parts that are available at your authorized dealer or at www.fordparts.com. We engineer these parts for your vehicle to meet or exceed our specifications. Use of other parts could impact vehicle performance, emissions and durability. Your warranty could be void for any damage related to use of other parts.

Capacities and Specifications

ENGINE OIL CAPACITY AND SPECIFICATION - 2.7L ECOBOOST™

Use oil that meets the defined specification and viscosity grade.

If you do not use oil that meets the defined specification and viscosity grade, it could result in:

- Component damage that your vehicle warranty does not cover.
- Longer engine cranking periods.
- Increased emission levels.
- Reduced vehicle performance.
- Reduced fuel economy.



An oil that displays this symbol conforms to current engine, emission system and fuel economy performance standards of ILSAC.

We recommend Motorcraft® motor oil for your vehicle. If Motorcraft® oil is not available, use motor oils of the recommended viscosity grade that display the API Certification Mark for gasoline engines.

Do not use supplemental engine oil additives because they are unnecessary and could lead to engine damage that your vehicle warranty does not cover.

Capacities

| Variant | Including the Oil Filter |
|---------|--------------------------|
| All. | 6.0 qt (5.7 L) |

Materials

| Name | Specification |
|--|---------------|
| Motorcraft® SAE 5W-30 Synthetic Blend Motor Oil(U.S.) Motorcraft® SAE 5W-30 Super Premium Motor Oil / Huile moteur de très haute qualité SAE 5W-30 Motorcraft®(Canada) XO-5W30-Q1SP(U.S.) CXO-5W30-LSP6(Canada) | WSS-M2C961-A1 |

Capacities and Specifications

Alternative Engine Oil for Extremely Cold Climates

use the following engine oil in climates where the ambient temperature reaches -22.0°F (-30°C) or below.

To improve engine cold start performance,

Materials

| Name | Specification |
|--|---------------|
| Engine Oil - SAE 0W-30 - Synthetic Blend | WSS-M2C963-A1 |

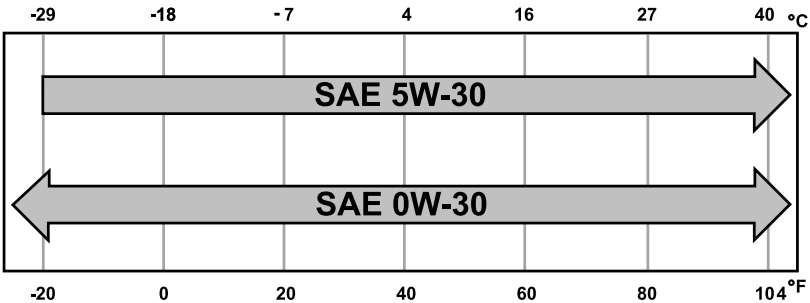

ENGINE OIL CAPACITY AND SPECIFICATION - 3.3L

Use oil that meets the defined specification and viscosity grade.

If you do not use oil that meets the defined specification and viscosity grade, it could result in:

- Component damage that your vehicle warranty does not cover.
- Longer engine cranking periods.
- Increased emission levels.
- Reduced vehicle performance.
- Reduced fuel economy.



An oil that displays this symbol conforms to current engine, emission system and fuel economy performance standards of ILSAC.

Capacities and Specifications

We recommend Motorcraft® motor oil for your vehicle. If Motorcraft® oil is not available, use motor oils of the recommended viscosity grade that display the API Certification Mark for gasoline

engines.

Do not use supplemental engine oil additives because they are unnecessary and could lead to engine damage that your vehicle warranty does not cover.

Capacities

| Variant | Including the Oil Filter |
|---------|--------------------------|
| All. | 6.0 qt (5.7 L) |

Materials

| Name | Specification |
|--|---------------|
| Motorcraft® SAE 5W-20 Synthetic Blend Motor Oil(U.S.) Motorcraft® SAE 5W-20 Super Premium Motor Oil / Huile moteur de très haute qualité SAE 5W-20 Motorcraft®(Canada) XO-5W20-Q1SP(U.S.) CXO-5W20-LSP6(Canada) | WSS-M2C960-A1 |

Alternative Engine Oil for Extremely Cold Climates

To improve engine cold start performance, use the following engine oil in climates where the ambient temperature reaches -22.0°F (-30°C) or below.

Materials

| Name | Specification |
|---|---------------|
| Motorcraft® SAE 0W-20 Full Synthetic Motor Oil(U.S.) (Canada) XO-0W20-QFS(U.S.) | WSS-M2C962-A1 |

Capacities and Specifications

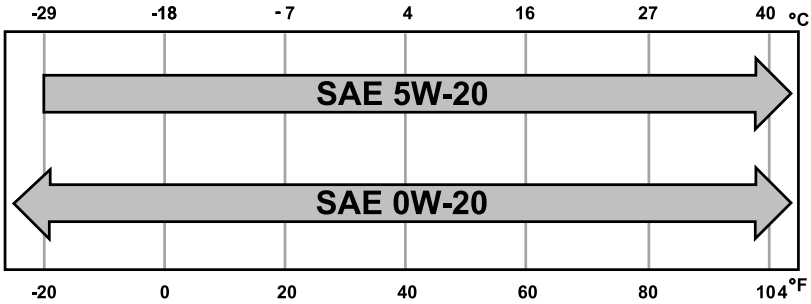

ENGINE OIL CAPACITY AND SPECIFICATION - 3.5L ECOBOOST™

Use oil that meets the defined specification and viscosity grade.

If you do not use oil that meets the defined specification and viscosity grade, it could result in:

- Component damage that your vehicle warranty does not cover.
- Longer engine cranking periods.
- Increased emission levels.
- Reduced vehicle performance.
- Reduced fuel economy.



An oil that displays this symbol conforms to current engine, emission system and fuel economy performance standards of ILSAC.

We recommend Motorcraft® motor oil for your vehicle. If Motorcraft® oil is not available, use motor oils of the recommended viscosity grade that display the API Certification Mark for gasoline engines.

Do not use supplemental engine oil additives because they are unnecessary and could lead to engine damage that your vehicle warranty does not cover.

Capacities and Specifications

Capacities

| Variant | Including the Oil Filter |
|---------|--------------------------|
| All. | 6.0 qt (5.7 L) |

Materials

| Name | Specification |
|--|---------------|
| Motorcraft® SAE 5W-30 Synthetic Blend Motor Oil(U.S.) Motorcraft® SAE 5W-30 Super Premium Motor Oil / Huile moteur de très haute qualité SAE 5W-30 Motorcraft®(Canada) XO-5W30-Q1SP(U.S.) CXO-5W30-LSP6(Canada) | WSS-M2C961-A1 |

Alternative Engine Oil for Extremely Cold Climates

To improve engine cold start performance, use the following engine oil in climates where the ambient temperature reaches -22.0°F (-30°C) or below.

Materials

| Name | Specification |
|--|---------------|
| Engine Oil - SAE 0W-30 - Synthetic Blend | WSS-M2C963-A1 |

Capacities and Specifications

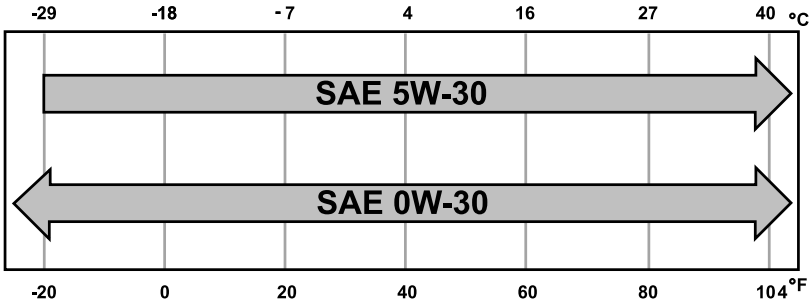

ENGINE OIL CAPACITY AND SPECIFICATION-3.5L, HYBRID ELECTRIC VEHICLE (HEV)

Use oil that meets the defined specification and viscosity grade.

If you do not use oil that meets the defined specification and viscosity grade, it could result in:

- Component damage that your vehicle warranty does not cover.
- Longer engine cranking periods.
- Increased emission levels.
- Reduced vehicle performance.
- Reduced fuel economy.



An oil that displays this symbol conforms to current engine, emission system and fuel economy performance standards of ILSAC.

We recommend Motorcraft® motor oil for your vehicle. If Motorcraft® oil is not available, use motor oils of the recommended viscosity grade that display the API Certification Mark for gasoline engines.

Do not use supplemental engine oil additives because they are unnecessary and could lead to engine damage that your vehicle warranty does not cover.

Capacities and Specifications

Capacities

| Variant | Including the Oil Filter |
|---------|--------------------------|
| All. | 6.0 qt (5.7 L) |

Materials

| Name | Specification |
|--|---------------|
| Motorcraft® SAE 5W-30 Synthetic Blend Motor Oil(U.S.) Motorcraft® SAE 5W-30 Super Premium Motor Oil / Huile moteur de très haute qualité SAE 5W-30 Motorcraft®(Canada) XO-5W30-Q1SP(U.S.) CXO-5W30-LSP6(Canada) | WSS-M2C961-A1 |

Alternative Engine Oil for Extremely Cold Climates

To improve engine cold start performance, use the following engine oil in climates where the ambient temperature reaches -22.0°F (-30°C) or below.

Materials

| Name | Specification |
|--|---------------|
| Engine Oil - SAE 0W-30 - Synthetic Blend | WSS-M2C963-A1 |

Capacities and Specifications

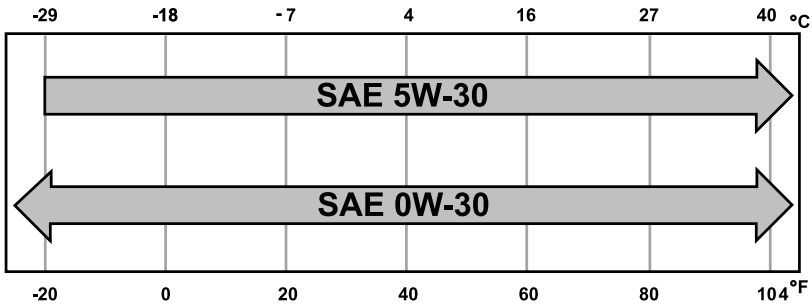

ENGINE OIL CAPACITY AND SPECIFICATION - 5.0L

Use oil that meets the defined specification and viscosity grade.

If you do not use oil that meets the defined specification and viscosity grade, it could result in:

- Component damage that your vehicle warranty does not cover.
- Longer engine cranking periods.
- Increased emission levels.
- Reduced vehicle performance.
- Reduced fuel economy.



An oil that displays this symbol conforms to current engine, emission system and fuel economy performance standards of ILSAC.

We recommend Motorcraft® motor oil for your vehicle. If Motorcraft® oil is not available, use motor oils of the recommended viscosity grade that display the API Certification Mark for gasoline engines.

Do not use supplemental engine oil additives because they are unnecessary and could lead to engine damage that your vehicle warranty does not cover.

Capacities and Specifications

Capacities

| Variant | Including the Oil Filter |
|---------|--------------------------|
| All. | 7.75 qt (7.33 L) |

Materials

| Name | Specification |
|--|---------------|
| Motorcraft® SAE 5W-30 Synthetic Blend Motor Oil(U.S.) Motorcraft® SAE 5W-30 Super Premium Motor Oil / Huile moteur de très haute qualité SAE 5W-30 Motorcraft®(Canada) XO-5W30-Q1SP(U.S.) CXO-5W30-LSP6(Canada) | WSS-M2C961-A1 |

Alternative Engine Oil for Extremely Cold Climates

To improve engine cold start performance, use the following engine oil in climates where the ambient temperature reaches -22.0°F (-30°C) or below.

Materials

| Name | Specification |
|--|---------------|
| Engine Oil - SAE 0W-30 - Synthetic Blend | WSS-M2C963-A1 |

Capacities and Specifications

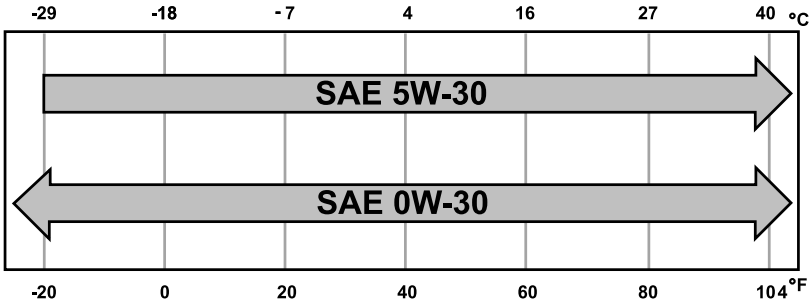

COOLING SYSTEM CAPACITY AND SPECIFICATION - 2.7L ECOBOOST™

Use coolant that meets the defined specification.

If you do not use coolant that meets the defined specification, it could result in:

- Component damage that your vehicle warranty does not cover.
- Reduced vehicle performance.

Capacities

| Variant | Quantity |
|---------|------------------|
| All. | 15.1 qt (14.3 L) |

Materials

| Name | Specification |
|---|---------------|
| Motorcraft® Yellow Prediluted Antifreeze/ Coolant(U.S.) Motorcraft® Yellow Prediluted Antifreeze/Coolant / Antigel/liquide de refroidissement prédilué jaune Motorcraft®(Canada) VC-13DL-G(U.S.) CVC-13DL-G(Canada) | WSS-M97B57-A2 |

Capacities and Specifications

COOLING SYSTEM CAPACITY AND SPECIFICATION - 3.3L

Use coolant that meets the defined specification.

If you do not use coolant that meets the defined specification, it could result in:

- Component damage that your vehicle warranty does not cover.
- Reduced vehicle performance.

Capacities

| Variant | Quantity |
|---------|----------------|
| All. | 12.7 qt (12 L) |

Materials

| Name | Specification |
|---|---------------|
| Motorcraft® Yellow Prediluted Antifreeze/Coolant (U.S.) Motorcraft® Yellow Prediluted Antifreeze/Coolant / Antigel/liquide de refroidissement prédilué jaune Motorcraft® (Canada) VC-13DL-G (U.S.) CVC-13DL-G (Canada) | WSS-M97B57-A2 |

COOLING SYSTEM CAPACITY AND SPECIFICATION - 3.5L ECOBOOST™

Use coolant that meets the defined specification.

If you do not use coolant that meets the defined specification, it could result in:

- Component damage that your vehicle warranty does not cover.
- Reduced vehicle performance.

Capacities

| Variant | Quantity |
|---------|------------------|
| All. | 14.3 qt (13.5 L) |

Capacities and Specifications

Materials

| Name | Specification |
|---|---------------|
| Motorcraft® Yellow Prediluted Antifreeze/ Coolant(U.S.) Motorcraft® Yellow Prediluted Antifreeze/Coolant / Antigel/liquide de refroidissement prédilué jaune Motorcraft®(Canada) VC-13DL-G(U.S.) CVC-13DL-G(Canada) | WSS-M97B57-A2 |

COOLING SYSTEM CAPACITY AND SPECIFICATION - 3.5L, HYBRID ELECTRIC VEHICLE (HEV)

Use coolant that meets the defined specification.

Capacities

| Variant | Quantity |
|-----------------------------------|------------------|
| Low temperature cooling circuit. | 7.2 qt (6.8 L) |
| High temperature cooling circuit. | 15.3 qt (14.5 L) |

If you do not use coolant that meets the defined specification, it could result in:

- Component damage that your vehicle warranty does not cover.
- Reduced vehicle performance.

Materials

| Name | Specification |
|---|---------------|
| Motorcraft® Yellow Prediluted Antifreeze/ Coolant(U.S.) Motorcraft® Yellow Prediluted Antifreeze/Coolant / Antigel/liquide de refroidissement prédilué jaune Motorcraft®(Canada) VC-13DL-G(U.S.) CVC-13DL-G(Canada) | WSS-M97B57-A2 |

Capacities and Specifications

COOLING SYSTEM CAPACITY AND SPECIFICATION - 5.0L

Use coolant that meets the defined specification.

If you do not use coolant that meets the defined specification, it could result in:

- Component damage that your vehicle warranty does not cover.
- Reduced vehicle performance.

Capacities

| Variant | Quantity |
|---------|------------------|
| All. | 13.2 qt (12.5 L) |

Materials

| Name | Specification |
|---|---------------|
| Motorcraft® Yellow Prediluted Antifreeze/Coolant (U.S.) Motorcraft® Yellow Prediluted Antifreeze/Coolant / Antigel/liquide de refroidissement prédilué jaune Motorcraft® (Canada) VC-13DL-G (U.S.) CVC-13DL-G (Canada) | WSS-M97B57-A2 |

COOLING SYSTEM CAPACITY AND SPECIFICATION - RAPTOR, POLICERESPONDER

Use coolant that meets the defined specification.

If you do not use coolant that meets the defined specification, it could result in:

- Component damage that your vehicle warranty does not cover.
- Reduced vehicle performance.

Capacities

| Variant | Quantity |
|---------|----------------|
| All. | 13.7 qt (13 L) |

Capacities and Specifications

Materials

| Name | Specification |
|---|---------------|
| Motorcraft® Yellow Prediluted Antifreeze/ Coolant(U.S.) Motorcraft® Yellow Prediluted Antifreeze/Coolant / Antigel/liquide de refroidissement prédilué jaune Motorcraft®(Canada) VC-13DL-G(U.S.) CVC-13DL-G(Canada) | WSS-M97B57-A2 |

FUEL TANK CAPACITY - GASOLINE, HYBRID ELECTRIC VEHICLE (HEV)

Capacities

| Variant | Quantity |
|---------|--------------------|
| All. | 30.6 gal (115.8 L) |

Capacities and Specifications

FUEL TANK CAPACITY - GASOLINE, EXCLUDING: HYBRID ELECTRIC VEHICLE (HEV)

Capacities

| Variant | Quantity |
|--------------|--------------------|
| Regular cab. | 23.0 gal (87.1 L) |
| Super cab. | 23.0 gal (87.1 L) |
| Crew cab. | 26.0 gal (98.4 L) |
| Optional. | 36.0 gal (136.3 L) |

Capacities and Specifications

FUEL TANK CAPACITY - RAPTOR

Capacities

| Variant | Quantity |
|---------|--------------------|
| All. | 36.0 gal (136.3 L) |

Capacities and Specifications

AIR CONDITIONING SYSTEM CAPACITY AND SPECIFICATION - 2.7L ECOBOOST™



WARNING: The air conditioning refrigerant system contains refrigerant under high pressure. Only qualified personnel should service the air conditioning refrigerant system. Opening

the air conditioning refrigerant system can cause personal injury.

Use refrigerant and oil that meets the defined specifications.

If you do not use refrigerant and oil that meets the defined specifications, it could result in:

- Component damage that your vehicle warranty does not cover.
- Reduced vehicle performance.

Capacities

| Variant | Refrigerant | Refrigerant Oil |
|---------|-----------------|--------------------|
| All. | 29 oz (0.82 kg) | 2.71 fl oz (80 ml) |

Materials

| Name | Specification |
|---|---------------|
| R-1234yf Refrigerant(U.S.) R-1234yf Refrigerant / Frigorigène R-1234yf(Canada) YN-33-A(U.S.) HS7Z-19B519-BA(Canada) | WSS-M17B21-A |
| Motorcraft® R-1234yf Refrigerant PAG Oil(U.S.) Motorcraft® R-1234yf Refrigerant PAG Oil / Huile PAG pour frigorigène R-1234yf Motorcraft®(Canada) YN-35(U.S. & Canada) | WSS-M2C300-A2 |

Capacities and Specifications

AIR CONDITIONING SYSTEM CAPACITY AND SPECIFICATION - 3.3L



WARNING: The air conditioning refrigerant system contains refrigerant under high pressure. Only qualified personnel should service the air conditioning refrigerant system. Opening

the air conditioning refrigerant system can cause personal injury.

Use refrigerant and oil that meets the defined specifications.

If you do not use refrigerant and oil that meets the defined specifications, it could result in:

- Component damage that your vehicle warranty does not cover.
- Reduced vehicle performance.

Capacities

| Variant | Refrigerant | Refrigerant Oil |
|---------|-----------------|--------------------|
| All. | 29 oz (0.82 kg) | 2.71 fl oz (80 ml) |

Materials

| Name | Specification |
|---|---------------|
| R-1234yf Refrigerant(U.S.) R-1234yf Refrigerant / Frigorigène R-1234yf(Canada) YN-33-A(U.S.) HS7Z-19B519-BA(Canada) | WSS-M17B21-A |
| Motorcraft® R-1234yf Refrigerant PAG Oil(U.S.) Motorcraft® R-1234yf Refrigerant PAG Oil / Huile PAG pour frigorigène R-1234yf Motorcraft®(Canada) YN-35(U.S. & Canada) | WSS-M2C300-A2 |

Capacities and Specifications

AIR CONDITIONING SYSTEM CAPACITY AND SPECIFICATION - 3.5L ECOBOOST™



WARNING: The air conditioning refrigerant system contains refrigerant under high pressure. Only qualified personnel should service the air conditioning refrigerant system. Opening

the air conditioning refrigerant system can cause personal injury.

Use refrigerant and oil that meets the defined specifications.

If you do not use refrigerant and oil that meets the defined specifications, it could result in:

- Component damage that your vehicle warranty does not cover.
- Reduced vehicle performance.

Capacities

| Variant | Refrigerant | Refrigerant Oil |
|---------|-----------------|--------------------|
| All. | 29 oz (0.82 kg) | 2.71 fl oz (80 ml) |

Materials

| Name | Specification |
|---|---------------|
| R-1234yf Refrigerant(U.S.) R-1234yf Refrigerant / Frigorigène R-1234yf(Canada) YN-33-A(U.S.) HS7Z-19B519-BA(Canada) | WSS-M17B21-A |
| Motorcraft® R-1234yf Refrigerant PAG Oil(U.S.) Motorcraft® R-1234yf Refrigerant PAG Oil / Huile PAG pour frigorigène R-1234yf Motorcraft®(Canada) YN-35(U.S. & Canada) | WSS-M2C300-A2 |

Capacities and Specifications

AIR CONDITIONING SYSTEM CAPACITY AND SPECIFICATION - 3.5L HYBRID ELECTRIC VEHICLE (HEV)

the air conditioning refrigerant system can cause personal injury.

Use refrigerant and oil that meets the defined specifications.

If you do not use refrigerant and oil that meets the defined specifications, it could result in:

- Component damage that your vehicle warranty does not cover.
- Reduced vehicle performance.



WARNING: The air conditioning refrigerant system contains refrigerant under high pressure. Only qualified personnel should service the air conditioning refrigerant system. Opening

Capacities

| Variant | Refrigerant | Refrigerant Oil |
|---------|-------------------|--------------------|
| All. | 26.5 oz (0.75 kg) | 5.4 fl oz (160 ml) |

Materials

| Name | Specification |
|---|---------------|
| R-1234yf Refrigerant(U.S.) R-1234yf Refrigerant / Frigorigène R-1234yf(Canada) YN-33-A(U.S.) HS7Z-19B519-BA(Canada) | WSS-M17B21-A |
| Motorcraft® R-1234yf Refrigerant POE Oil(U.S.) Motorcraft® R-1234yf Refrigerant POE Oil / Huile POE pour frigorigène R-1234yf Motorcraft®(Canada) YN-34(U.S. & Canada) | WSS-M2C31-B2 |

Capacities and Specifications

AIR CONDITIONING SYSTEM CAPACITY AND SPECIFICATION - 5.0L



WARNING: The air conditioning refrigerant system contains refrigerant under high pressure. Only qualified personnel should service the air conditioning refrigerant system. Opening

the air conditioning refrigerant system can cause personal injury.

Use refrigerant and oil that meets the defined specifications.

If you do not use refrigerant and oil that meets the defined specifications, it could result in:

- Component damage that your vehicle warranty does not cover.
- Reduced vehicle performance.

Capacities

| Variant | Refrigerant | Refrigerant Oil |
|---------|-----------------|--------------------|
| All. | 29 oz (0.82 kg) | 2.71 fl oz (80 ml) |

Materials

| Name | Specification |
|---|---------------|
| R-1234yf Refrigerant(U.S.) R-1234yf Refrigerant / Frigorigène R-1234yf(Canada) YN-33-A(U.S.) HS7Z-19B519-BA(Canada) | WSS-M17B21-A |
| Motorcraft® R-1234yf Refrigerant PAG Oil(U.S.) Motorcraft® R-1234yf Refrigerant PAG Oil / Huile PAG pour frigorigène R-1234yf Motorcraft®(Canada) YN-35(U.S. & Canada) | WSS-M2C300-A2 |

WASHER FLUID SPECIFICATION

Capacities

| Variant | Quantity |
|---------|-------------------|
| All. | Fill as required. |

Capacities and Specifications

Materials

| Name | Specification |
|---|---------------|
| Motorcraft® Premium Windshield Wash Concentrate with Bitterant(U.S.) Motorcraft® Premium Quality Windshield Washer Fluid / Liquide lave-glace de haute qualité Motorcraft®(Canada) ZC-32-B2(U.S.) CXC-37-F/M(Canada) | WSS-M14P19-A |

BRAKE FLUID SPECIFICATION

Use fluid that meets the defined specification and viscosity grade.

If you do not use fluid that meets the defined specification and viscosity grade, it could result in:

- Component damage that your vehicle warranty does not cover.
- Reduced brake performance.

Note: We recommend you use Dot 4 Low Viscosity (LV) High Performance Brake Fluid meeting WSS-M6C65-A2 specifications or ISO 4925 Class 6 standards. If you use any fluid other than the recommended fluid, it could cause reduced brake performance and not meet our performance standards. Keep brake fluid clean and dry. Contamination with dirt, water, petroleum products or other materials could result in brake system damage and possible failure.

Capacities

| Variant | Quantity |
|---------|-------------------|
| All. | Fill as required. |

Materials

| Name | Specification |
|---|---------------|
| Motorcraft® DOT 4 LV High Performance Motor Vehicle Brake Fluid(U.S.) Motorcraft® DOT 4 LV High Performance Motor Vehicle Brake Fluid / Liquide de frein automobile haute performance DOT 4 LV Motorcraft®(Canada) PM-20(U.S. & Canada) | WSS-M6C65-A2 |

Capacities and Specifications

TRANSFER CASE FLUID CAPACITY AND SPECIFICATION

Use fluid that meets the defined specification and viscosity grade.

If you do not use fluid that meets the defined specification and viscosity grade, it could result in:

- Component damage that your vehicle warranty does not cover.
- Reduced vehicle performance.

Capacities

| Variant | Quantity |
|---|----------------|
| Four-wheel drive (Electronic shift on the Fly). | 1.5 qt (1.4 L) |
| Automatic four-wheel drive (Torque on demand). | 1.5 qt (1.4 L) |
| Two-speed automatic four-wheel drive (Mechanical lock). | 1.9 qt (1.8 L) |

Materials

| Name | Specification |
|--|-------------------------|
| Motorcraft® MERCON® LV Automatic Transmission Fluid(U.S.) Motorcraft® MERCON® LV Automatic Transmission Fluid / Huile pour boîte automatique MERCON® LV Motorcraft®(Canada) XT-10-QLVC(U.S.) CXT-10-LV6(Canada) | WSS-M2C938-AMERCON® LV, |

TRANSFER CASE FLUID CAPACITY AND SPECIFICATION - RAPTOR

Use fluid that meets the defined specification and viscosity grade.

If you do not use fluid that meets the defined specification and viscosity grade, it could result in:

- Component damage that your vehicle warranty does not cover.
- Reduced vehicle performance.

Capacities

| Variant | Quantity |
|--|----------------|
| Two-speed four-high lock (Torque on demand). | 1.9 qt (1.8 L) |

Capacities and Specifications

Materials

| Name | Specification |
|--|-------------------------|
| Motorcraft® MERCON® LV Automatic Transmission Fluid(U.S.) Motorcraft® MERCON® LV Automatic Transmission Fluid / Huile pour boîte automatique MERCON® LV Motorcraft®(Canada) XT-10-QLVC(U.S.) CXT-10-LV6(Canada) | WSS-M2C938-AMERCON® LV, |

FRONT AXLE FLUID CAPACITY AND SPECIFICATION

Use fluid that meets the defined specification and viscosity grade.

If you do not use fluid that meets the defined specification and viscosity grade, it could result in:

- Component damage that your vehicle warranty does not cover.
- Reduced vehicle performance.

Capacities

| Variant | Quantity |
|--------------------------------------|-------------------------------|
| With standard front axle. | 1.8 qt (1.7 L) |
| With Torsen limited slip front axle. | 1.64 qt (1.55 L) ¹ |

¹For complete refill of limited slip axles, add 4.0 fl oz (118.5 ml) of Additive Friction Modifier XL-3 or equivalent, meeting specification EST-M2C118-A. Include this friction modifier in the total lube volume of 1.64 qt (1.55 L).

Capacities and Specifications

Materials

| Name | Specification |
|---|---------------|
| Motorcraft® Additive Friction Modifier(U.S.) Motorcraft® Additive Friction Modifier / Additif modificateur de friction Motorcraft®(Canada) XL-3(U.S.) CXL-3(Canada) | EST-M2C118-A |
| Motorcraft® SAE 75W-85 Premium Synthetic Hypoid Gear Lubricant(U.S.) Motorcraft® SAE 75W-85 Premium Synthetic Hypoid Gear Lubricant / Huile synthétique de haute qualité pour engrenages hypoides SAE 75W-85 Motorcraft®(Canada) XY-75W85-QL(U.S. & Canada) | WSS-M2C942-A |

REAR AXLE FLUID CAPACITY AND SPECIFICATION

Use fluid that meets the defined specification and viscosity grade.

If you do not use fluid that meets the defined specification and viscosity grade, it could result in:

- Component damage that your vehicle warranty does not cover.
- Reduced vehicle performance.

Capacities

| Variant | Quantity |
|------------|------------------------|
| 8.8 inch. | 2.0–2.1 qt (1.9–2 L) |
| 9.75 inch. | 2.2–2.3 qt (2.1–2.2 L) |

Materials

| Name | Specification |
|---|---------------|
| Motorcraft® SAE 75W-85 Premium Synthetic Hypoid Gear Lubricant(U.S.) Motorcraft® SAE 75W-85 Premium Synthetic Hypoid Gear Lubricant / Huile synthétique de haute qualité pour engrenages hypoides SAE 75W-85 Motorcraft®(Canada) XY-75W85-QL(U.S. & Canada) | WSS-M2C942-A |

Capacities and Specifications

REAR AXLE FLUID CAPACITY AND SPECIFICATION - RAPTOR

Use fluid that meets the defined specification and viscosity grade.

If you do not use fluid that meets the defined specification and viscosity grade, it could result in:

- Component damage that your vehicle warranty does not cover.
- Reduced vehicle performance.

Capacities

| Variant | Quantity |
|------------|--------------------------|
| 9.75 inch. | 2.5–2.6 qt (2.36–2.44 L) |

Materials

| Name | Specification |
|--|---------------|
| Motorcraft® SAE 75W-85 Premium Synthetic Hypoid Gear Lubricant(U.S.) Motorcraft® SAE 75W-85 Premium Synthetic Hypoid Gear Lubricant / Huile synthétique de haute qualité pour engrenages hypoides SAE 75W-85 Motorcraft®(Canada) XY-75W85-QL(U.S. & Canada) | WSS-M2C942-A |

REAR AXLE FLUID CAPACITY AND SPECIFICATION - POLICE RESPONDER

Use fluid that meets the defined specification and viscosity grade.

If you do not use fluid that meets the defined specification and viscosity grade, it could result in:

- Component damage that your vehicle warranty does not cover.
- Reduced vehicle performance.

Capacities

| Variant | Quantity |
|------------|------------------------|
| 9.75 inch. | 2.2–2.3 qt (2.1–2.2 L) |

Capacities and Specifications

Materials

| Name | Specification |
|--|---------------|
| Motorcraft® SAE 75W-85 Premium Synthetic Hypoid Gear Lubricant (U.S.) Motorcraft® SAE 75W-85 Premium Synthetic Hypoid Gear Lubricant / Huile synthétique de haute qualité pour engrenages hypoides SAE 75W-85 Motorcraft® (Canada) XY-75W85-QL (U.S. & Canada) | WSS-M2C942-A |

Vehicle Identification

VEHICLE IDENTIFICATION NUMBER

LOCATING THE VEHICLE IDENTIFICATION NUMBER

The vehicle identification number is on the left-hand side of the instrument panel.

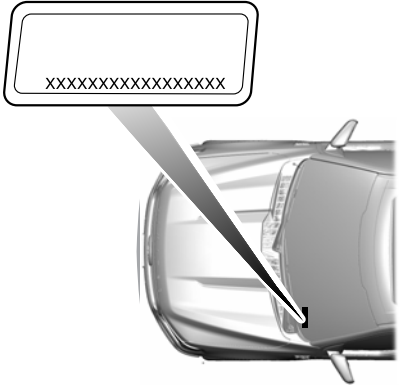

Note: In the illustration, XXXX is representative of your vehicle identification number.

VEHICLE IDENTIFICATION NUMBER OVERVIEW

The vehicle identification number contains the following information:

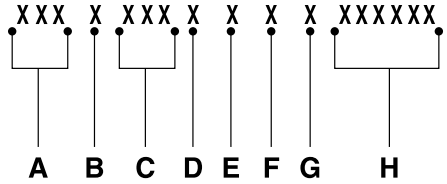

- A World manufacturer identifier.
- B Brake system, gross vehicle weight rating, restraint devices and their locations.
- C Make, vehicle line, series, body type.
- D Engine or motor type.
- E Check digit.
- F Model year.
- G Assembly plant.
- H Production sequence number.

Connected Vehicle

WHAT IS A CONNECTED VEHICLE

A connected vehicle has technology that allows your vehicle to connect to a mobile network and for you to access a range of features. When used in conjunction with the FordPass app, it could allow you to monitor and control your vehicle further, for example checking the tire pressures, the fuel level and the vehicle location. For additional information, refer to the local Ford website.

CONNECTED VEHICLE REQUIREMENTS

Connected service and related feature functionality requires a compatible vehicle network.

Some remote features require additional service activation. Log in to your Ford account for details. Some restrictions, third party terms and message or data rates may apply.

CONNECTED VEHICLE LIMITATIONS

Evolving technology, cellular networks, or regulations could affect functionality and availability, or continued provision of some features. These changes could even stop some features from functioning.

CONNECTING THE VEHICLE TO A MOBILE NETWORK

WHAT IS THE MODEM



The modem allows access to a range of features built into your vehicle.

ENABLING AND DISABLING THE MODEM

1. Press **Settings**.
2. Press **Connectivity**.
3. Press **Connected Vehicle Features**.
4. Switch vehicle connectivity on or off.

CONNECTING FORDPASS TO THE MODEM

1. Make sure that the modem is enabled using the vehicle settings menu.
2. Open the FordPass app on your device and log in.
3. Add your vehicle or select your vehicle if already added.
4. Select the option to activate your vehicle.
5. Make sure that the name on the screen matches the name shown in your FordPass account.
6. Confirm that FordPass account is connected to the modem.

CONNECTING THE VEHICLE TO A WI-FI NETWORK



Select the settings option on the feature bar.

1. Press **Connectivity**.
2. Press **Manage Wi-Fi Networks**.
3. Switch **Wi-Fi** on.
4. Press **View Available Networks**.
5. Select an available Wi-Fi network.

Note: Enter the network password to connect to a secure network.

Connected Vehicle

CONNECTED VEHICLE – TROUBLESHOOTING

CONNECTED VEHICLE – FREQUENTLY ASKED QUESTIONS - VEHICLES WITH: MODEM

| Symptom | Possible Cause and Resolution |
|--|--|
| I cannot confirm the connection of my FordPass account to the modem. | <ul style="list-style-type: none">- Modem is not enabled.<ul style="list-style-type: none">• Switch vehicle connectivity on.- Weak network signal.<ul style="list-style-type: none">• Move your vehicle closer to a place where the network signal is not obstructed. |

Connected Vehicle

CONNECTED VEHICLE – FREQUENTLY ASKED QUESTIONS - VEHICLES WITH: SYNC 4

Why can I not confirm the connection of my FordPass account to the modem?

- The modem is not enabled. Switch vehicle connectivity on.
- The network signal is weak. Move your vehicle closer to a place where the network signal is not obstructed.

Why can I not connect to a Wi-Fi network?

- You entered the wrong network password. Enter the correct password.
- The network signal is weak. Move your vehicle closer to the Wi-Fi router or to a place where the network signal is not obstructed.
- There are multiple access points in range with the same network name. Choose a unique name for your network. Do not use the default name unless it contains a unique identifier, for example as part of the MAC address.

Why does the Wi-Fi connection disconnect after successful connection?

- The network signal is weak. Move your vehicle closer to the Wi-Fi router or to a place where the network signal is not obstructed.

What can I do if I am close to a Wi-Fi router but the network signal strength is weak?

- If your vehicle has a heated windshield, position your vehicle so that the windshield is not facing the Wi-Fi router.

- If your vehicle has metallic tinting on the windows but not on the windshield, position your vehicle so that the windshield is facing the Wi-Fi router or open the windows that are facing the router.
- If your vehicle has metallic tinting on the windows and the windshield, open the windows that are facing the router.
- If your vehicle is in a garage and you have the garage door closed, open the garage door as it could block the signal.

Why can I not see a network I expect to see in the list of available networks?

- The network is hidden. Make the network visible and try again, or manually add a network in the Wi-Fi settings menu.
- Some network security types are not supported, for example WEP.

Why do software downloads take too long?

- The network signal is weak. Move your vehicle closer to the Wi-Fi router or to a place where the network signal is not obstructed.
- Wi-Fi network is in high demand or has a slow Internet connection. Use a more reliable Wi-Fi network.

Connected Vehicle

Why does the software not update when the system seems to connect to a Wi-Fi network and the signal strength is excellent?

- No software update is available at this time.
- Select automatic updates option in the settings menu to enable automatic software update or contact an authorized dealer.
- There could be a connection problem. Test the network using another device.

Vehicle Wi-Fi Hotspot

CREATING A VEHICLE WI-FI HOTSPOT

You can create a Wi-Fi hotspot in your vehicle and allow devices to connect to it for access to the Internet.



Select the settings option on the feature bar.

1. Press **Vehicle Hotspot**.

Note: The vehicle hotspot default setting is on.

2. Press **Settings**.
3. Press **Edit**.
4. Press **Hotspot visibility**.

Note: The hotspot visibility default setting is on.

Finding the Wi-Fi Hotspot Name and Password



Select the settings option on the feature bar.

1. Press **Vehicle Hotspot**.
2. Press **Settings**.

Note: The network name is the hotspot name.

3. Press **View Password**.

Connecting a Device to the Wi-Fi Hotspot

1. On your device, switch Wi-Fi on and select the hotspot from the list of available Wi-Fi networks.
2. When prompted, enter the password.

Purchasing a Data Plan

1. Connect a device to the hotspot.

Note: The vehicle network carrier's portal opens on your device.

2. If the portal does not open on your device, open a website and it redirects to the vehicle network carrier's portal.

Note: Secure websites do not redirect.

3. Follow the instructions on the carrier portal to purchase a plan.

Note: If you have an active plan, the system does not redirect to the vehicle network carrier's portal when you connect a device. Visit the vehicle network carrier's website to purchase more data.

Note: If data usage information is available in the vehicle hotspot menu, it is approximate.

Note: If you carry out a master reset, the system does not remove your vehicle from your vehicle network carrier's account. To remove your vehicle from the account, contact your vehicle network carrier.

Note: The vehicle network carrier provides Vehicle Hotspot services, subject to your vehicle network carrier agreement, coverage and availability.

CHANGING THE VEHICLE WI-FI HOTSPOT NAME OR PASSWORD



Select the settings option on the feature bar.

1. Press **Vehicle Hotspot**.
2. Press **Settings**.
3. Press **Edit**.
4. Press **Change Network Name**.
5. Enter your required network name.
6. Press **Done**.
7. Press **Change Password**.
8. Enter your required password.
9. Press **Done**.

Vehicle Wi-Fi Hotspot

Changing the Wi-Fi Hotspot Frequency

Note: *The vehicle hotspot frequency band is selectable depending upon your device capabilities. You will not be able to connect your device to the vehicle hotspot if it does not support the selected frequency band.*



Select the settings option on the feature bar.

1. Press **Vehicle Hotspot**.
2. Press **Settings**.
3. Press **Edit**.
4. Select a frequency.

Audio System

AUDIO SYSTEM PRECAUTIONS



WARNING: Driving while distracted can result in loss of vehicle control, crash and injury. We strongly recommend that you use extreme caution when using any device that may take your focus off the road. Your primary responsibility is the safe operation of your vehicle. We recommend against the use of any hand-held device while driving and encourage the use of voice-operated systems when possible. Make sure you are aware of all applicable local laws that may affect the use of electronic devices while driving.

Listening to loud audio for long periods of time could damage your hearing.

IDENTIFYING THE AUDIO UNIT



Depending on your vehicle options, the controls may look different from what you see here.

SWITCHING THE AUDIO UNIT ON AND OFF



Press the button on the volume control.

SELECTING THE AUDIO SOURCE

Audio Unit



Press to open the media source menu.

You can press this multiple times to change the audio source or scroll through the media sources.

Touchscreen

Press **Sources** on the touchscreen to open the media source menu.

PLAYING OR PAUSING THE AUDIO SOURCE

Audio Unit



Press the button to pause playback. Press again to resume playback.

Touchscreen



Press the button to pause playback. Press again to resume playback.

Note: *Not all sources can be paused.*

Audio System

ADJUSTING THE VOLUME

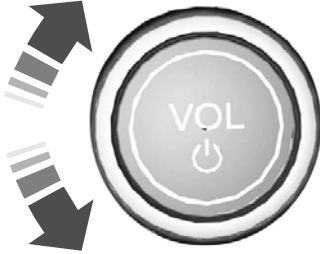

Turn to adjust the volume.

Some vehicles may be able to adjust the volume using buttons on the steering wheel.

SWITCHING SHUFFLE MODE ON AND OFF



Press the button on the touchscreen to switch shuffle mode on or off.

Note: *Not all sources have shuffle mode.*

SWITCHING REPEAT MODE ON AND OFF



Press the button on the touchscreen to switch repeat mode on or off.

Note: *Not all sources have repeat mode.*

SETTING A MEMORY PRESET

1. Select a station or channel.
2. Press and hold a memory preset button on the touchscreen.

Note: *The audio mutes briefly while the system saves the preset and returns once it is stored.*

Note: *You can save presets from multiple sources to the memory preset bar.*

MUTING THE AUDIO



Press to mute the signal. Press again to restore the signal.

ADJUSTING THE SOUND SETTINGS

Balance and Fade (If Equipped)

1. Press **Settings** on the touchscreen.
2. Press **Sound Settings**.
3. Press **Balance / Fade**.
4. Press the arrows to adjust the settings.

Tone Settings

1. Press **Settings** on the touchscreen.
2. Press **Sound Settings**.
3. Press **Tone Settings**.
4. Press the arrows or slider bar to adjust the settings.

Speed Compensated Volume

1. Press **Settings** on the touchscreen.
2. Press **Sound Settings**.
3. Press **Speed Compensated Volume**.
4. Press a setting.

Audio System

Occupancy Mode (If Equipped)

1. Press **Settings** on the touchscreen.
2. Press **Sound Settings**.
3. Press **Occupancy Mode**.
4. Press a setting.

Sound Mode (If Equipped)

1. Press **Settings** on the touchscreen.
2. Press **Sound Settings**.
3. Press **Sound Mode**.
4. Press a setting.

SETTING THE CLOCK AND DATE

1. Press **Settings** on the touchscreen.
2. Press **Clock Settings**.
3. Set the time.

Note: The **AM** and **PM** options are not available if **24-hour mode** is on.

Switching Automatic Time Updates On and Off

1. Press **Settings** on the touchscreen.
2. Press **Clock Settings**.
3. Switch **Automatic time zone update** on or off.

AM/FM RADIO

AM/FM RADIO LIMITATIONS

The further you travel from an AM or FM station, the weaker the signal and the weaker the reception.

Hills, mountains, tall buildings, bridges, tunnels, freeway overpasses, parking garages, dense tree foliage and thunderstorms can interfere with the reception.

When you pass a ground-based broadcast repeating tower, a stronger signal may overtake a weaker one and result in the audio system muting.

SELECTING A RADIO STATION

Manually Selecting a Radio Station

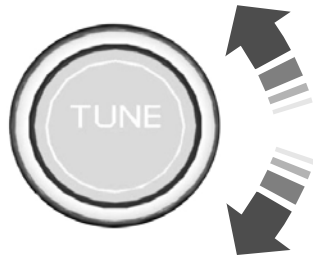

Turn to search through the radio frequency band.

Using Direct Tune

1. Press **Direct Tune** to open the number pad.
2. Enter the station you prefer.

Note: You can only enter a valid station for the audio source you are currently listening to.

Audio System

Using Seek



Press either button. The system stops at the first station it finds in that direction.



Using the Station List

1. Press **Browse**.

Note: Available on FM radio only.

2. Press a station.

SWITCHING THE DISPLAY ON AND OFF

Audio Unit



Press the button.

Touchscreen

To switch the display off:

1. Press **Settings** on the touchscreen.
2. Press **Display Settings**.
3. Press **Display Off**.

Note: The display defaults to on each time you switch your vehicle on.

To switch the display on, press anywhere on the touchscreen.

DIGITAL RADIO (IF EQUIPPED)

WHAT IS DIGITAL RADIO

HD Radio™ technology is the digital evolution of analog AM/FM radio.

For additional information, visit www.HDRadio.com.

HD Radio Technology is manufactured under license from iBiquity Digital Corporation and foreign patents. HD Radio and the HD and HD Radio logos are proprietary trademarks of DTS. The vehicle manufacturer and DTS are not responsible for the content sent using HD Radio technology. Content may be changed, added or deleted at any time at the station owner's discretion.

HOW DOES DIGITAL RADIO WORK

Your system has a special receiver that allows it to receive digital broadcasts in addition to analog broadcasts.

HD1 signifies the main programming status and is available in both analog and digital broadcasts. Other multicast stations are only available digitally and could contain new or different content.

Note: When the system first receives an HD1 station, it plays the station in the analog version until it verifies the station is an HD Radio station. Then it shifts to the digital version.

Note: There is an audio mute delay when switching to an HD2 or HD3 station because the system has to reacquire and decode the digital signal.

DIGITAL RADIO LIMITATIONS

If you are outside the reception area, the system could not work.

If you are on the fringe of the reception area, the station could mute due to weak signal strength.

Note: If you are listening to HD1, the system changes back to the analog broadcast until the digital broadcast is available again. If you are listening to any other multicast channels, the station mutes and stays muted unless it is able to connect to the digital signal again.

Audio System

Depending on the station quality, you could hear a slight sound change when the station changes between analog and digital audio.

You cannot access a saved HD station if your vehicle is outside the station's reception area.

SWITCHING DIGITAL RADIO RECEPTION ON AND OFF

1. Press **Settings** on the touchscreen.
2. Press **Radio Settings**.
3. Switch **AM HD Radio** or **FM HD Radio** on or off.

DIGITAL RADIO INDICATORS

HD Radio Indicator

The indicator appears when HD Radio is on and you tune to a station broadcasting HD Radio technology.



The color of the indicator changes to indicate the system status.

Gray indicates the system is acquiring a digital station.

Orange indicates digital audio is playing.

Multicast Indicator

The multicast indicator appears if the current station is broadcasting multiple digital broadcasts. The highlighted numbers indicate additional digital channels available.

Note: For stations that have more than one HD multicast, the HD indicator and radio text appears as a button. Press the button to cycle through all of the HD stations on that specific frequency.

SATELLITE RADIO (IF EQUIPPED)

WHAT IS SATELLITE RADIO

Your factory-installed SiriusXM radio system includes a limited subscription term, which begins on the date of sale or lease of your vehicle. See an authorized dealer for availability.

For additional information about extended subscription terms, visit www.SiriusXM.com in the United States, www.SiriusXM.ca in Canada, or call SiriusXM at 1-888-539-7474.

Note: SiriusXM reserves the unrestricted right to change, rearrange, add or delete programming including canceling, moving or adding particular channels, and its prices, at any time, with or without notice to you. Neither SiriusXM and its affiliates nor Ford Motor Company and its affiliates will be liable to you or any third party for any such modification, suspension or termination.

SATELLITE RADIO LIMITATIONS

For optimal reception performance, keep the antenna clear of snow and ice build-up and keep luggage and other material as far away from the antenna as possible. Placing luggage over the antenna may reduce performance. Factory-installed and aftermarket vehicle structures including, but not limited to, roof racks and soft top roofs in a partially open position could reduce reception performance.

Audio System

Hills, mountains, tall buildings, bridges, tunnels, freeway overpasses, parking garages, dense tree foliage and thunderstorms can interfere with your reception.

When you pass a ground-based broadcast-repeating tower, a stronger signal may overtake a weaker one and could result in the audio system muting. Your display could show an error message to indicate the interference.

LOCATING THE SATELLITE RADIO IDENTIFICATION NUMBER

1. Select SiriusXM as the audio source.
2. Tune to channel 0.

SELECTING A CHANNEL

Manually Selecting a Channel

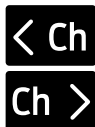

Press the button to find the previous or next available radio channel.

Linear Tuner

The linear tuner is displayed when manually selecting a channel. You can swipe left or right on the linear tuner carousel to navigate through the channel list. Tap on a channel title to listen to it.

Using Direct Tune

1. Press the channel up or down button to open the linear tuner screen.
2. Press **Direct Tune** to open the number pad.
3. Enter the channel you prefer.

Using Browse

1. Press **Browse**.

2. Select a channel.

SATELLITE RADIO SETTINGS

Subscription

Your subscription status is displayed. You can subscribe or manage your subscription directly from the touchscreen.

Listener Add/Switch

You can create up to five listener profiles per SiriusXM account. Each listener profile can be personalized with a name and profile image.

Note: Requires a trial or active subscription to use.

Note: A default profile is available when no listener profiles are created.

SiriusXM Favorites

SiriusXM Favorites are shown for the active listener profile. While you are listening to SiriusXM, you can save favorites by:

- Tapping the currently tuned channel or show logo on the SiriusXM audio screen. A favorite icon appears next to the logo when it is saved as a favorite.
- Tuning to a channel or show you want to save as a favorite. Navigate to the SiriusXM Favorites screen and press the Add Current button. The currently tuned channel or show is saved as a favorite.
- Saving a radio preset. This saves the currently tuned SiriusXM channel or show as a favorite.

Note: Requires a trial or active subscription to use.

Audio System

Listening History

Listening history is a list of recently listened to SiriusXM content and is shown for the active listener profile. You can view, manage and reset the listening history using the controls on the touchscreen.

Note: Requires a trial or active subscription to use.

Listener Settings

Listener settings apply to the active listener profile.

Note: Requires a trial or active subscription to use.

Note: A default profile is available when no listener profiles are created.

Help and Support

You can contact SiriusXM Customer Care directly from SYNC and view information required to manage your SiriusXM account.

Audio System

AUDIO SYSTEM – TROUBLESHOOTING

AUDIO SYSTEM – INFORMATION MESSAGES

Satellite Radio Troubleshooting

| Error Message | Potential Effects | Recommended Action |
|-------------------------|---|--|
| Connectivity Disabled | Internet streaming and On Demand shows are unavailable and some SiriusXM features are disabled. | Internet connectivity is turned off. See Connected Vehicle (page 597). |
| No Internet | Audio system may mute. "Switch to Satellite" button may be displayed on the SiriusXM audio screen if the channel is also available via satellite. | SYNC will attempt to connect. See Satellite Radio Limitations (page 607). Switch to a satellite connection for the current channel if the option is available. |
| No Satellite Signal | Audio system may mute. "Switch to Internet" button may be displayed on the SiriusXM audio screen if the channel is also available via streaming. | Antenna may be obstructed or satellite reception is weak in your location. See Satellite Radio Limitations (page 607). Switch to an internet connection for the current channel if the option is available. |
| Slow Network Connection | Audio system may mute while audio attempts to load. | Allow some time for audio to load or tune to a different channel. |
| Channel Unavailable | Audio system may mute. Radio may tune to a different channel. | A temporary update may be in progress. Allow some time before retrying to tune to the channel. If issue persists, the channel may no longer be available. |
| Episode Unavailable | Audio system may mute. Radio may tune to a different channel. | A temporary update may be in progress. Allow some time before retrying to play the episode. If issue persists, the episode may no longer be available. |

Audio System

| | | |
|----------------------|---|--|
| Something went wrong | Audio system may mute. Radio may tune to a different channel. | Retry action after some time or tune to a different channel. |
| Subscribe to Listen | Cannot listen to selected content. Content may appear grayed out and some features may be disabled. | <p>Your subscription has expired or you have not yet subscribed for access to the listed content. Navigate to Subscription under the Satellite Radio Settings menu. If you have an active subscription which includes the listed channel or content and you see this error, you may need to refresh your radio. To refresh your SiriusXM radio, visit www.siriusxm.com/refresh in the US, or www.siriusxm.ca/refresh in Canada.</p> <p>You may need to provide your SiriusXM Radio identification number. See Locating the Satellite Radio Identification Number (page 608).</p> |

Audio System

| | | |
|--|--|--|
| <p>Upgrade to Listen</p> | <p>Cannot listen to selected content. Content may appear grayed out and some features may be disabled.</p> | <p>Your subscription does not include access to the listed content. You may need to upgrade your subscription. Navigate to Subscription under the Satellite Radio Settings menu. If you have an active subscription which includes the listed channel or content and you see this error, you may need to refresh your radio. To refresh your SiriusXM radio, visit www.siriusxm.com/refresh in the US, or www.siri-usxm.ca/refresh in Canada. You may need to provide your SiriusXM Radio identification number. See Locating the Satellite Radio Identification Number (page 608).</p> |
| <p>Location Restricted Content</p> | <p>Audio may mute. “Not available in your location” or “Unable to determine your location” may be displayed.</p> | <p>Content is not available in your location or SiriusXM is unable to determine your location. Tuning to a different channel may resolve the issue.</p> |
| <p>Channel Blocked</p> | <p>Audio may mute. Radio may tune to a different channel.</p> | <p>The Block Explicit Content filter is turned on. Navigate to Listener Settings under the Satellite Radio Settings menu to access the Block Explicit Content filter. Navigate to Listener Settings. See Satellite Radio Settings (page 608).</p> |
| <p>Antenna Problem or Hardware Problem</p> | <p>Audio may mute. Access to SiriusXM features may be unavailable.</p> | <p>If issue persists, you may need to visit an authorized dealer for service.</p> |

Audio System

| | | |
|----------------------|---|---|
| SiriusXM Updating... | Audio may mute. | Allow SiriusXM some time to complete updating. |
| Loading... | Audio may mute. Content may be temporarily unavailable while loading. | No action necessary. If loading time is longer than usual, See Satellite Radio Limitations (page 607). |
| SiriusXM Loading... | Audio may mute. Content and controls may be temporarily unavailable. | No action necessary. Allow SiriusXM some time to finish loading. |

Center Display Overview

CENTER DISPLAY PRECAUTIONS



WARNING: Driving while distracted can result in loss of vehicle control, crash and injury. We strongly recommend that you use extreme caution when using any device that may take your focus off the road. Your primary responsibility is the safe operation of your vehicle. We recommend against the use of any hand-held device while driving and encourage the use of voice-operated systems when possible. Make sure you are aware of all applicable local laws that may affect the use of electronic devices while driving.

CENTER DISPLAY LIMITATIONS

Speed-restricted Features

For your safety, some features are not available while the vehicle is in motion at or above 5 mph (8 km/h). Settings that are not critical while driving your vehicle are shown as restricted on your display. Some of these settings include:

- System updates.
- Personal profiles setup.
- Valet mode setup.
- Driver assistance settings.

Vehicle Settings

- MyKey setup.
- Door keypad code setup.
- Backup start passcode setup.

These restricted features become available when your vehicle is no longer in motion.

STATUS BAR

The bar is on top of the display and indicates the status of your vehicle's features.

Audio System



Audio system muted.

Connected Device



Cell phone microphone muted.



Phone call in progress.



Media player connected.



Cell phone network signal strength.



Cell phone roaming.



Text message received.



Unread email message.



Automatic crash notification system off.



Cell phone battery status.

Vehicle Data



Wi-Fi available.

Center Display Overview



Wi-Fi connected.



Vehicle data sharing on.



Vehicle data sharing off.



Vehicle location sharing on.



Vehicle data and vehicle location sharing on.

Vehicle System Update



Vehicle system update available.



Vehicle system update requires schedule.



Vehicle system update requires consent.



Vehicle system update requires Wi-Fi.



Vehicle system update schedule reminder.



Vehicle system update not successful.



Vehicle system update successful.

Wireless Accessory Charger



Wireless accessory charger active.

FEATURE BAR

The feature bar is located on the bottom of the display and allows you to access vehicle features.



Press to use the radio, a USB, a media player or a **Bluetooth®** device.



Press to make calls and access the phonebook on your cell phone.



Press to use the navigation system.



Press to replace this button with a shortcut to a feature or setting.



Press to search for and use compatible apps on your iOS or Android device.



Press to adjust system settings.



Press to view features.



Note: The icon may be different depending on your vehicle.

Center Display Overview

INFORMATION ON DEMAND SCREEN - VEHICLES WITH: 12.3 INCH SCREEN

The information on demand screen displays cards on the side of the display and allows you to see information from different features.



Press the button to view the next card.



Press the button to view the previous card.



Press the button to view available cards.

REBOOTING THE CENTER DISPLAY

You can reboot the center display using the controls on the steering wheel.

1. Simultaneously press and hold the seek forward and audio system power button for 10 seconds.

Voice Interaction

WHAT IS VOICE INTERACTION

Voice Interaction allows you to control vehicle features using conversational requests.

SETTING THE WAKE WORD

1. Press the Settings option on the feature bar.
2. Press the Voice Control button.
3. Switch on Listen for Wake Word.
4. Press Preferred Wake Word
5. Select a wake word.

BEGINNING A VOICE INTERACTION

Say the selected wake word.



Press the voice interaction button on the steering wheel.

VOICE INTERACTION EXAMPLES

Note: You may need to enable your vehicle's modem to use certain voice commands. See **Enabling and Disabling the Modem** (page 597).

General Examples

| Command | Result |
|----------------|---|
| Start Over. | The system resets the current voice interaction. |
| Cancel. | The system ends the current voice interaction. |
| Next Page. | The system goes to the next page. |
| Previous Page. | The system goes to the previous page. |
| Help. | The system displays a list of available commands you can use on the current screen. |

Entertainment Examples

| Command | Result |
|--------------------------------------|---|
| Play The Beatles. | The system plays the selected music. |
| Show music by The Beatles. | The system shows the selected music. |
| Tune to FM 101.9. | The system tunes the radio to 101.9 FM. |
| Set the station to Sirius Channel 2. | The system tunes the radio to Sirius Channel 2. |

Voice Interaction

Climate Examples

| Command | Result |
|-------------------------------------|---|
| Set the temperature to low. | The system sets the temperature to the minimum. |
| Set the temperature to 72°F (22°C). | The system sets the temperature to 72°F (22°C). |

Phone Examples

| Command | Result |
|-------------------------------|--|
| Call Henry. | The system calls Henry using your connected device. |
| Dial (phone number). | The system dials the selected phone number. |
| Send a text message to Henry. | The system begins a dictated text message. |
| Read my message from Henry. | The system reads you the most recent message from Henry. |

Apps Examples

| Command | Result |
|-------------------|---|
| Mobile Apps. | The system prompts you to say the name of an app to start it on the system. |
| List Mobile Apps. | The system will list all of the currently available Mobile Apps. |
| Find Mobile Apps | The system will search and connect to compatible app running on your mobile device. |

Navigation Examples

| Command | Result |
|--|---|
| Drive to 125 Main Street, New York. | The system begins guided navigation to the address. |
| Where is ___ | The system searches for the requested point of interest. |
| Show me directions to Oakwood Boulevard and Pelham Road. | The system shows directions to the selected intersection. |
| Cancel route. | The system ends guided navigation to the destination. |

Ford Assistant Examples

Note: When you are not driving, additional commands are available by using popular chat applications. Use FordPass to setup a conversation with your Ford assistant.

Voice Interaction

Remote Vehicle Control Examples

| Command | Result |
|-----------------------------|---|
| How much gas is in my tank? | The vehicle tells you how much gas it has left. |

Maintenance and Roadside Assistance Examples

| Command | Result |
|---------------------------|--|
| Call roadside assistance. | Your vehicle calls the roadside assistance phone number. |

Vehicle Information Examples

| Command | Result |
|-----------------------------------|--|
| How does cruise control work? | Information about the feature appears on the center display or FordPass app. |
| What does the warning light mean? | Information about the warning light appears on the center display or FordPass app. |
| Am I affected by any recalls? | Information about open recalls appears on the center display or FordPass app. |

Phone

PHONE PRECAUTIONS



WARNING: Driving while distracted can result in loss of vehicle control, crash and injury. We strongly recommend that you use extreme caution when using any device that may take your focus off the road. Your primary responsibility is the safe operation of your vehicle. We recommend against the use of any hand-held device while driving and encourage the use of voice-operated systems when possible. Make sure you are aware of all applicable local laws that may affect the use of electronic devices while driving.

CONNECTING YOUR PHONE

Go to the settings menu on your device and switch **Bluetooth®** on.



Press the phone option on the feature bar.

1. Press **Add Phone**.

Note: A prompt alerts you to search for your vehicle on your cell phone.

2. Select your vehicle on your cell phone.

Note: A number appears on your cell phone and on the touchscreen.

3. Confirm the number on your cell phone matches the number on the touchscreen.

Note: The touchscreen indicates that you have successfully paired your cell phone.

4. Download the phonebook from your cell phone when you are prompted.

Note: If you pair more than one cell phone, use the phone settings on the center display to specify the primary phone. You can change this setting at any time.

PHONE MENU

This menu becomes available after pairing a phone.

Recent Call List

Display and select an entry from a list of previous calls.

Contacts

Display a smart search form to look up your contacts. Use the List button to alphabetically sort your contacts.

Favorites

Display the list of favorite contacts that are set up on your phone.

Messaging

Displays the list of text messages to read, listen to, or respond to.

Email

Displays the list of emails to read, listen to, or respond to.

Phone List

Display the list of paired or connected devices that you can select.

Note: Up to 12 devices can be stored.

Do Not Disturb

Reject incoming calls and switch ring tones and alerts off.

Phone Keypad

Directly dial a number.

Phone

Voice Control

Say a command to use the Google or Siri voice assistant available on your connected phone to access supported features.

Note: *Some features under the phone menu may not be available if the feature is not supported through the phone.*

Phone

MAKING AND RECEIVING A PHONE CALL

Making Calls

To call a number in your contacts, select:

| Menu Item | Action and Description |
|-----------|---|
| Contacts | You can then select the name of the contact you want to call. Any numbers stored for that contact display along with any stored contact photos. You can then select the number that you want to call. The system begins the call. |

To call a number from your recent calls, select:

| Menu Item | Action and Description |
|------------------|---|
| Recent Call List | You can then select an entry that you want to call. The system begins the call. |

To call a number from your favorites, select:

| Menu Item | Action and Description |
|-----------|---|
| Favorites | You can then select an entry that you want to call. The system begins the call. |

To call a number that is not stored in your phone, select:

| Menu Item | Action and Description |
|--------------|---|
| Phone Keypad | Select the digits of the number you wish to call. |
| Call | The system begins the call. |

Pressing the backspace button deletes the last digit you typed.

Receiving Calls

During an incoming call, an audible tone sounds. Caller information appears in the display if it is available.

To accept the call, select:

| Menu Item |
|-----------|
| Accept |

Note: You can also accept the call by pressing the phone button on the steering wheel.

To reject the call, select:

| Menu Item |
|-----------|
| Reject |

Ignore the call by doing nothing. The system logs it as a missed call.

During a Phone Call

During a phone call, the contacts name and number display on the screen along with the call duration.

The phone status items are also visible:

- Signal Strength.
- Battery.

You can select any of the following during an active phone call:

Phone

| Item | |
|----------|--|
| End Call | Immediately end a phone call. You can also press the button on the steering wheel. |
| Keypad | Press this to access the phone keypad. |

| Item | |
|---------|--|
| Mute | You can switch the microphone off so the caller does not hear you. |
| Privacy | Transfer the call to the cell phone or back to the touch-screen. |

SENDING AND RECEIVING A TEXT MESSAGE

| Menu Item | Description |
|-----------|---|
| Hear It | Hear the text message. |
| View | View the text message. |
| Call | Call the sender. |
| Reply | Reply to the text message with a standard text message. |

Phone

SWITCHING TEXT MESSAGE NOTIFICATION ON AND OFF

IOS

1. Go to the settings menu on your cell phone.
2. Select **Bluetooth®**.
3. Select the information icon to the right of your vehicle.
4. Switch text message notification on or off.

Android

1. Go to the settings menu on your cell phone.
2. Select **Bluetooth®**.
3. Select the profiles option.
4. Select the phone profile.
5. Switch text message notification on or off.

Bluetooth®

CONNECTING A BLUETOOTH® DEVICE

1. Make sure **Bluetooth®** is enabled on your device.
2. Press **Settings** on the touchscreen.
3. Press **Connectivity**.
4. Press **Bluetooth**.
5. Press **Add a Bluetooth Device**.

Note: A prompt alerts you to search for your vehicle on your device.

6. Select your vehicle on your device.

Note: A number appears on your device and on the touchscreen.

7. Confirm that the number on your device matches the number on the touchscreen.

Note: The touchscreen indicates that you have successfully paired your device.

The **Bluetooth®** word mark and logos are registered trademarks owned by **Bluetooth SIG, Inc.** and any use of such marks by Ford Motor Company is under license. Other trademarks and trade names are those of their respective owners.

PLAYING MEDIA USING BLUETOOTH®



WARNING: Driving while distracted can result in loss of vehicle control, crash and injury. We strongly recommend that you use extreme caution when using any device that may take your focus off the road. Your primary responsibility is the safe operation of your vehicle. We recommend against the use of any

hand-held device while driving and encourage the use of voice-operated systems when possible. Make sure you are aware of all applicable local laws that may affect the use of electronic devices while driving.

Connect your device.



Press the audio button on the feature bar.



Press **Sources**.



Press the **Bluetooth®** option.



Press to play a track. Press again to pause the track.



Press to skip to the next track.

Press and hold to fast forward through the track.



Press once to return to the beginning of a track. Repeatedly press to return to previous

tracks.

Press and hold to fast rewind through the track.

Apps

APP PRECAUTIONS



WARNING: Driving while distracted can result in loss of vehicle control, crash and injury. We strongly recommend that you use extreme caution when using any device that may take your focus off the road. Your primary responsibility is the safe operation of your vehicle. We recommend against the use of any hand-held device while driving and encourage the use of voice-operated systems when possible. Make sure you are aware of all applicable local laws that may affect the use of electronic devices while driving.

APP REQUIREMENTS

When you start an app through the system for the first time, you could be asked to grant certain permissions. You can review and change the permissions that you have granted at any time when your vehicle is not moving. We recommend that you check your data plan before using your apps through the system. Using them could result in additional charges. We also recommend that you check the app provider's terms and conditions and privacy policy before using their app. Make sure that you have an active account for apps that you want to use through the system. Some apps will work with no setup. Others require you to configure some personal settings before you can use them.

ACCESSING APPS



Select the apps option on the feature bar.

ENABLING APPS ON AN IOS DEVICE



Select the apps option on the feature bar.

1. Select Mobile Apps Help.
2. Follow the instructions to pair and connect your device via **Bluetooth®** or with a USB cable.
3. Start the apps on your device that you want to use.
4. Select the app that you want to use on the touchscreen.

Note: Some apps may run through Apple CarPlay if it is enabled.

Note: Closing an app on your device will close it on the touchscreen.

Note: For troubleshooting assistance select Mobile Apps List under Mobile Apps Help.

ENABLING APPS ON AN ANDROID DEVICE



Select the apps option on the feature bar.

1. Select Mobile Apps Help.
2. Follow the instructions to pair and connect your device via **Bluetooth®** or with a USB cable.
3. Start the apps on your device that you want to use.
4. Select **Find Mobile Apps**.
5. Select the app that you want to use on the touchscreen.

Note: Some devices may lose the ability to play music over USB when Mobile Apps are enabled.

Note: Some apps may run through Android Auto if it is enabled.

Apps

Note: Closing an app on your device will close it on the touchscreen.

Note: For troubleshooting assistance select *Mobile Apps List* under *Mobile Apps Help*.

SWITCHING APPLE CARPLAY ON AND OFF

Enabling Apple CarPlay with USB

1. Connect your device to a USB port.
2. Follow the instructions on your device and the touchscreen.

Note: Selecting "Enable Wireless CarPlay" on your device will prepare the device for wireless carplay when you re-enter the vehicle.

Enabling Apple CarPlay with Wireless

1. Pair your device to **Bluetooth®**.
2. Follow the instructions on your device and the touchscreen.

Disabling Apple CarPlay



Select the settings option on the feature bar.

1. Press Phone List.
2. Select your device from the list.
3. Press Disable.

Re-Enabling Apple CarPlay



Select the settings option on the feature bar.

1. Press Phone List.
2. Select your device from the list.
3. Press Connect to Apple CarPlay.

SWITCHING ANDROID AUTO ON AND OFF

Enabling Android Auto with USB

(If Equipped)

1. Connect your device to a USB port.
2. Follow the instructions on the touchscreen.

Note: Certain features of the system are not available when you are using Android Auto.

Enabling Android Auto with Wireless

1. Pair your device to **Bluetooth®**.
2. Follow the instructions on your device and the touchscreen.

Note: Certain Android Devices do not support Android Auto Wireless. Please check your Android OS version for compatibility.

Disabling Android Auto



Select the settings option on the feature bar.

1. Press Phone List.
2. Select your device from the list.
3. Press Disable.

Re-Enabling Android Auto



Select the settings option on the feature bar.

1. Press Phone List.
2. Select your device from the list.
3. Press Connect to Android Auto.

Personal Profiles (If Equipped)

HOW DO PERSONAL PROFILES WORK

This feature allows you to create multiple personal profiles enabling users to personalize vehicle's settings such as seats and mirrors, as well as non-positional settings like radio, navigation, driver assist system settings. Positional settings are saved by holding a memory seat button. Non-positional settings are saved you change a setting while a profile is active. You can create one profile for each preset memory seat button along with a guest profile.

Recalling and Changing a Profile

You can recall a profile using the touchscreen or the preset button you selected when you created your profile. You can also link a remote control and a mobile device to your profile, which are used to recall it.

ENABLING OR DISABLING PERSONAL PROFILES

When you switch on the Personal Profiles feature:

- Unlocking a door with a remote control or mobile device that is not linked to a driver profile does not change the active profile, but remains in the last known profile. It does not change the positional settings.
- Pressing a memory seat button that is not linked to a driver profile or saved to a preset setting does not change the active profile, but remains in the last known profile. It does not change the positional settings.
- Pressing a memory seat button that is not linked to a driver profile but is saved to a preset setting does not change the active profile, but remains in the last known profile. It recalls the positional settings that you saved to that memory seat button.

When you switch off a Personal Profiles feature:

- Unlocking a door with a remote control or mobile device does not recall any non-positional settings but still recalls positional settings from the driver profile which the remote control or mobile device is linked to.
- Pressing a memory seat button that is not linked to a driver profile or saved to a preset setting does not change the positional or non-positional settings.
- Pressing a memory seat button that is linked to a driver profile or has saved to a preset setting recalls the positional settings that you saved to that memory seat button.

CREATING A PERSONAL PROFILE

Use the touchscreen to create a personal profile.

1. Switch the vehicle on and leave the vehicle in park (P).
2. Select the Personal Profiles button under Settings.
3. Follow the instructions on the display.

LINKING OR UNLINKING A PERSONAL PROFILE TO A REMOTE CONTROL

You can save preset memory positions for up to three remote controls by assigning a remote control to a personal profile using the touchscreen.

Use the touchscreen to link a remote control to a personal profile.

1. Switch the vehicle on and leave the vehicle in park (P).
2. Select the Personal Profiles button under Settings.
3. Touch the arrow for the profile you wish to link to a remote control.
4. Select remote control.
5. Follow the instructions on the display.

Note: *If more than one linked remote control is in range, the memory function moves to the settings of the first key to initiate a memory recall.*

Note: *The guest profile consists of existing settings when there is no driver profile created. After you create a driver profile, the guest profile serves as an additional driver profile.*

Note: *You cannot link a remote control to a guest profile.*

Navigation (If Equipped)

ACCESSING NAVIGATION



Press the button to access Navigation.

Note: *As the driver, be aware of all local traffic regulations and road attributes, and operate your vehicle in a safe and legal manner.*

NAVIGATION MAP UPDATES

To update your Map data over Wi-Fi, your vehicle must be connected to a Wi-Fi access point. For USB updates and other details, contact dealers at 1-866-462-8837 in the United States and Canada, or 01-800-557-5539 in Mexico.

Note: *If you find map data errors, you may report them by going to www.here.com/mapcreator.*

ADJUSTING THE MAP

ZOOMING THE MAP IN AND OUT

You can use pinch gestures to zoom in and out. Place two fingers on the screen and move them apart to zoom in. Place two fingers on the screen and bring them together to zoom out.

CHANGING THE FORMAT OF THE MAP



Press the Menu button.

1. Press the Map Orientation tile.
2. Select a map orientation.

LIVE TRAFFIC

WHAT IS LIVE TRAFFIC

You can observe real-time road congestion when live traffic is on.

SWITCHING LIVE TRAFFIC ON AND OFF



Press the Menu button.

1. Press the Traffic on Map tile.
2. Press Traffic on or Traffic Off.

SETTING A DESTINATION

SETTING A DESTINATION USING THE TEXT ENTRY SCREEN

1. Press the search bar at the top of the screen.
2. Enter your destination using the keyboard.
3. Press Search.
4. Select a destination from the list.
5. Press Start to begin navigation.

SETTING A DESTINATION USING THE MAP SCREEN

Press and hold on the map to place a pin at that location. Information about the location of the pin appears on the screen.



Press the button to begin navigation to the pin.

Navigation (If Equipped)

SETTING A DESTINATION USING A PREDICTIVE DESTINATION

Press the predicted destination card on the screen to navigate to it. These appear when the navigation system has learned your driving habits.

SETTING A DESTINATION USING A RECENT DESTINATION



Press the button.

Press a destination from the list.

Note: You can also use the search button to view recent destinations.

SETTING A DESTINATION USING A SAVED DESTINATION

Press the star icon next when viewing location details to save the location.



Press the button.

Press a destination from the list.

Note: You can also use the search button to view saved destinations.

SETTING A DESTINATION USING A POINT OF INTEREST

Press a point of interest icon on the map. Information about the location of the point of interest appears on the screen.



Press the button to begin navigation to the point of interest.

Note: You can also use the search button to view points of interest.

WAYPOINTS

ADDING A WAYPOINT



Press the Add Waypoint button when in an active navigation session.

1. Enter your waypoint on the keyboard.
2. Press Search.
3. Select a waypoint from the list.
4. Press Add to Trip.

EDITING WAYPOINTS

1. Press the waypoint you would like to edit.
2. Select an option to reorder or delete the waypoint.

ROUTE GUIDANCE

ADJUSTING THE GUIDANCE PROMPT VOLUME

Turn the volume control when a guidance prompt plays to adjust the volume.

REPEATING AN INSTRUCTION

Press the turn indicator to hear the last voice instruction.

CANCELING ROUTE GUIDANCE



Press the button to cancel route guidance to the selected location.

TRAILER TOWING NAVIGATION

When you have an active subscription and Trailer Towing Navigation is switched on, the system will calculate the best route for trailer towing by avoiding dangerous road conditions based on the dimensions of your trailer.

Switching Trailer Towing Navigation On and Off

1. Press the **Navigation** button on the feature bar.
2. Press the **Menu** button.
3. Press **Trailer Routing**.
4. Switch **Trailer-optimized Routing** on or off.

Entering Trailer Dimensions

1. Press the **Navigation** button on the feature bar.
2. Press the **Menu** button.
3. Press **Trailer Routing**.
4. Press **Towing Menu**.
5. Press **Add Trailer**.
6. Follow the instructions on the screen to enter the type and dimensions of the trailer into the system.

Navigation Alerts

Alerts will appear on the navigation map while driving. An orange alert triangle indicates you should proceed with caution. When not following active guidance to a destination, a red alert triangle may appear and indicates you should avoid the road and find a detour.

Vehicle System Updates

UPDATING THE VEHICLE SYSTEMS WIRELESSLY



Over the air system updates allow you to update your vehicle system software wirelessly. To make sure you receive all updates, set a recurring schedule and connect to Wi-Fi. Updates may take longer if not connected to Wi-Fi, or may not download at all. See **Connected Vehicle** (page 597).

Over the Air System Update Requirements

Before updating, reference this list to make sure your vehicle is ready to be updated. If these requirements are not met during a scheduled update, the update will be canceled and you can reschedule.

- Your vehicle is not running.
- Your vehicle is stopped.
- Your vehicle is parked.
- The hazard indicators are switched off.
- The alarm is not sounding.
- The doors are closed.
- The parking lights are switched off.
- You are not pressing the brake pedal.
- An emergency call is not in progress.
- Your vehicle is not in limp mode.

Enabling Over the Air Updates

1. Press **Settings** on the touchscreen.
2. Press **Software Update**.
3. Switch **Automatic Updates** on or off.

Note: *Over the air updates are enabled by default.*

Note: *If you do not want to receive over the air updates you can turn them off. You will not be notified of new updates.*

Scheduling an Update

Scheduling an update allows you to set a convenient time for the update to complete. We recommend updating overnight when your vehicle is not in use. Ensure Vehicle Connectivity and Automatic Updates are enabled. Once you complete these steps, your schedule will be saved for future updates. As long as an update is not in process you can adjust your schedule.

Note: *Some updates may be applied outside of your set schedule. Information about the unscheduled update appears on the touchscreen after it is applied.*

Using the Settings Menu

1. Press **Settings** on the touchscreen.
2. Press **Software Update**.
3. Press **Schedule Updates**.
4. Use the controls to set the time and day of the update.
5. Save the schedule.

Note: *You can set the updates to occur at any time.*

Using the Status Bar Icon



When an update is available, tap the notification icon and follow the prompts on the screen.

Applying an Over the Air Update

You can see the progress of the update on the touchscreen. An update cannot be canceled once it has been started.

Vehicle System Updates

During an update you will not be able to drive your vehicle, start the vehicle, use remote controls to lock and unlock the vehicle. The alarm, central locks, and door tones are disabled. The electronic door lock will not function during an update. You can open the doors using the mechanical latch if child locks are not on. Pull the handle until it stops to use the mechanical latch. Some updates may not allow you to use your vehicle during the update process.

Note: *Some updates can complete in the background, but more complex updates can take up to 45 minutes.*

Note: *Double locking is switched off and central locking is switched on during and after an update.*

Note: *If your vehicle is plugged in, charging will stop during an update and resume when the update is complete.*

Viewing Update Details

If an update is successful, the touchscreen will provide additional details about the update. You can also access this information under the System Update tile.

If an update is not successful, follow the prompt that appears on the touchscreen.

PERFORMING A MASTER RESET



Press the settings option on the feature bar.

1. Press the **Reset** tile.
2. Press **Master Reset**.
3. Follow the prompts on the screen to complete the reset.

Accessories

For a complete listing of the accessories that are available for your vehicle, please contact your authorized dealer or visit the online store web site:

| |
|--|
| Web Address (United States) |
| www.Accessories.Ford.com |

| |
|--|
| Web Address (Canada) |
| www.Accessories.Ford.ca |

We will repair or replace any properly authorized dealer-installed Ford Original Accessory found to be defective in factory-supplied materials or workmanship during the warranty period, as well as any component damaged by the defective accessories.

We will warrant your Ford Original Accessory through the warranty that provides the greatest benefit:

- 24 months, unlimited mileage.
- The remainder of your new vehicle limited warranty.

Contact an authorized dealer for details and a copy of the warranty.

Ford Licensed Accessories are the accessory manufacturer's designs. The manufacturer develops and therefore warrants Ford Licensed Accessories, and does not design or test these accessories to Ford Motor Company engineering requirements. Contact an authorized Ford dealer for the manufacturer's limited warranty details, and request a copy of the Ford Licensed Accessories product limited warranty from the accessory manufacturer.

For maximum vehicle performance, keep the following information in mind when adding accessories or equipment to your vehicle:

- When adding accessories, equipment, passengers and luggage to your vehicle, do not exceed the total weight capacity of the vehicle or of the front or rear axle (GVWR or GAWR as indicated on the Safety Compliance Certification label). Ask an authorized dealer for specific weight information.
- The Federal Communications Commission (FCC) and Canadian Radio Telecommunications Commission (CRTC) regulate the use of mobile communications systems that are equipped with radio transmitters, for example two-way radios, telephones and theft alarms. Any such equipment installed in your vehicle should comply with Federal Communications Commission (FCC) and Canadian Radio Telecommunications Commission (CRTC) regulations and should be installed only by an authorized dealer.
- An authorized dealer needs to install mobile communications systems. Improper installation may harm the operation of your vehicle, particularly if the manufacturer did not design the mobile communication system specifically for automotive use.
- If you or an authorized Ford dealer add any non-Ford electrical or electronic accessories or components to your vehicle, you may adversely affect battery performance and durability. In addition, you may also adversely affect the performance of other electrical systems in the vehicle.

Auxiliary Switches

WHAT ARE THE AUXILIARY SWITCHES

The auxiliary switchboard on the overhead console makes aftermarket customization easier with six prewired switches connected to the power distribution box. Each circuit is individually fused for connection of electrical accessories.

For maximum vehicle performance, keep the following information in mind when adding accessories or equipment to your vehicle:

- When adding accessories, equipment, passengers and luggage to your vehicle, do not exceed the total weight capacity of the vehicle or of the front or rear axle (GVWR or GAWR as indicated on the safety compliance certification label). Ask an authorized dealer for specific weight information.
- It is your responsibility to ensure that any equipment you have fitted complies with applicable local legislation.
- An authorized dealer needs to install mobile communication systems. Improper installation may harm the operation of your vehicle, particularly if the manufacturer did not design the mobile communication system specifically for automotive use.
- If you or an authorized dealer add any electrical or electronic accessories or components not produced by us to your vehicle, you may adversely affect battery performance and durability. In addition, you may also adversely affect the performance of the other electrical systems in the vehicle.

LOCATING THE AUXILIARY SWITCHES

The auxiliary switchboard on the overhead console makes aftermarket customization easier with six prewired switches connected to the power distribution box. The circuits are individually fused for connection of electrical accessories.



The switches have labels for AUX 1 through AUX 6. They only operate when the ignition is in the on position, whether the engine is running or not. We recommend that you leave the engine running to maintain battery charge when using the switches for an extended time or when using higher current draw accessories. When you turn on a switch, the indicator light on the switch illuminates and the circuit provides power to the device wired to that switch.

Note: *AUX switch 1 operates the off-road lamps when your vehicle comes with this option.*

Auxiliary Switches

LOCATING THE AUXILIARY SWITCH WIRING

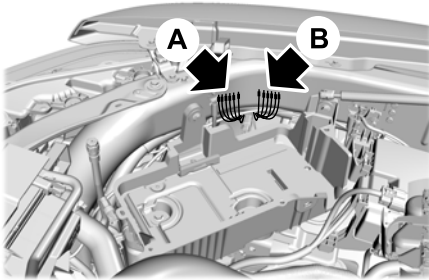

There are three sets of blunt-cut and sealed circuits. Two sets are under the hood and behind the battery tray, and one set is inside your vehicle at the passenger footwell.

The powered set (A) is taped behind the battery tray and has a red spot tape mark.

The second set (B) is also under the hood. It is taped behind the battery tray and has a white spot tape mark. This set routes to the interior passenger footwell.

Remove the battery and battery tray to access the underhood circuits.

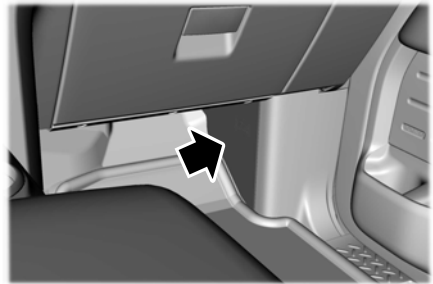

The interior set is taped on a wire harness by the passenger side footwell. This set is the other end of the circuits taped behind the battery tray, with a white spot tape mark.

Remove the fuse panel access door in the kick panel to access the wires. If you do not see them, you may need to pull them down.

See **Fuses** (page 472). See your authorized dealer for service.

Circuits from the under hood fuse box (A) are powered. All other circuits (B-E) are not connected at either end.

Additional information on fuse and relay locations is available. See **Fuses** (page 472). See your authorized dealer for service.

IDENTIFYING THE AUXILIARY SWITCH WIRING

The relays are coded as follows:

| Power Distribution Box | Wire Color | Under-hood Pass Through | Wire Color | Passenger Footwell | Wire Size | Fuse |
|------------------------|--------------|-------------------------|--------------|--------------------|---------------------|------|
| AUX 1 | Violet/Green | AUX 1 | Violet/Green | AUX 1 | 1.0 mm ² | 10A |
| AUX 2 | Green/Brown | AUX 2 | Green/Brown | AUX 2 | 1.0 mm ² | 15A |
| AUX 3 | Green/Blue | AUX 3 | Green/Blue | AUX 3 | 1.0 mm ² | 15A |

Auxiliary Switches

| Power Distribution Box | Wire Color | Under-hood Pass Through | Wire Color | Passenger Footwell | Wire Size | Fuse |
|-------------------------------|-------------------|--------------------------------|-------------------|---------------------------|---------------------|-------------|
| AUX 4 | Brown | AUX 4 | Brown | AUX 4 | 1.0 mm ² | 10A |
| AUX 5 | Blue/Orange | AUX 5 | Blue/Orange | AUX 5 | 1.0 mm ² | 5A |
| AUX 6 | Yellow/Orange | AUX 6 | Yellow/Orange | AUX 6 | 1.0 mm ² | 5A |

Warranty Terms and Conditions - Raptor

BASE WARRANTY

The F-150 Raptor carries the same New Vehicle Limited Warranty as other Ford F-150 models. This information is covered in its entirety in your warranty information.

Warranty service for the F-150 Raptor or any Ford Performance vehicle can be obtained at any Ford dealer nationwide.

Ford Performance does not recommend modifying or racing Ford Performance vehicles, as they are designed and built to be driven as delivered from the factory. The warranty information discusses vehicle usage and the installation of aftermarket parts and their effect on warranty coverage.

These modifications may not necessarily protect your engine from damage in competition conditions. Subjecting your vehicle to competition conditions even with these modifications may render repairs non-reimbursable under the New Vehicle Limited Warranty.

Ford Performance has engineered your F-150 Raptor for off-road use beyond what is normal for a F-150. However, it can incur damage if driven beyond its capabilities. Skid plates, shock guards and running boards were designed to help limit damage to vital components and exterior finishes, but cannot prevent all damage if driven in extreme off-road conditions. Damage to skid plates, shock guards, running boards and exterior finishes as well as bent, cracked or broken body, frame and chassis components may not be covered by warranty.

Vehicle damage caused by driving through deep water at excessive speeds may not be covered under warranty. See **Driving Through Water Limitations** (page 453).

Please see the warranty information for complete information.

Perform Multi-Point Inspection and the inspections outlined in Scheduled Maintenance information. Refer to the vehicle's Workshop Manual for removal and installation procedures. Replace with genuine Ford and Motorcraft service parts as needed.

Ford Protect

WHAT IS FORD PROTECT

Protect yourself from the rising cost of vehicle repairs with a Ford Protect extended service plan.

Ford Protect Extended Service Plans - United States Only

Ford Protect extended service plans mean peace of mind. Extended service plans are backed by Ford Motor Company, and provide more protection beyond the New Vehicle Limited Warranty coverage. When you visit your Ford Dealer, insist on the Ford Protect extended service plan.

Ford Protect Can Quickly Pay for Itself

One trip to the service center could easily exceed the price of your Ford Protect extended service plan. With the Ford Protect extended service plan, you minimize your risk for unexpected repair bills and rising repair costs.

Up to 1,000+ Covered Vehicle Components

There are four mechanical Ford Protect extended service plans with different levels of coverage. Ask your authorized dealer for details.

1. PremiumCARE - Our most comprehensive coverage. With over 1,000 covered components, this plan is so complete it is probably easier to list what is not covered.
2. ExtraCARE - Covers 113 components, and includes many high-tech items.
3. BaseCARE - Covers 84 components.
4. PowertrainCARE - Covers 29 critical components.

Ford Protect extended service plans are honored by all authorized Ford dealers in the United States, Canada and Mexico.

That means you get:

- Reliable, quality service at any Ford or Lincoln dealership.
- Repairs performed by factory trained technicians, using genuine parts.

Rental Car Reimbursement

First Day Rental Benefit

If you bring your car into your dealer for service, we will give you a rental vehicle to use for the day.

Extended Rental Benefits

If your vehicle is kept overnight for covered repairs, you are eligible for rental car coverage, warranty repairs, and field service actions.

Roadside Assistance

Exclusive 24/7 roadside assistance, including:

- Towing, flat-tire change and battery jump starts.
- Out of fuel and lock-out assistance.
- Travel expense reimbursement for lodging, meals and rental car.
- Assistance for taxi, shuttle, rental car coverage or other transportation.

Transferable Coverage

If you sell your vehicle before your Ford Protect extended service plan coverage expires, you can transfer any remaining coverage to the new owner. This should give you and your potential buyer peace of mind.

Ford Protect

Less Cost to Properly Maintain Your Vehicle

The Ford Protect extended service plan also offers a Premium Maintenance Plan that covers all scheduled maintenance, and selected wear items. The coverage is prepaid, so you never have to worry about the cost of your vehicle's maintenance.

Covered maintenance includes:

- Windshield wiper blades.
- Spark plugs.
- The clutch disc (if equipped).
- Brake pads and linings.
- Shock absorbers.
- Struts.
- Engine belts.
- Engine coolant hoses, clamps and o-rings.
- Diesel exhaust fluid replenishment (if equipped).
- Cabin air filter replacement every 20,000 mi (32,000 km) for electric vehicles only.

Interest Free Finance Options

Just a 5% down payment provides you with an affordable, no interest, no fee payment program allowing you all the security and benefits Ford Protect extended service plan has to offer while paying over time. You are pre-approved with no credit check or hassles. To learn more, call our Ford Protect extended service plan specialists at 800-367-3377.

Ford Protect Extended Service Plan
P.O. Box 321067
Detroit, MI 48232

Ford Protect Extended Service Plan (Canada Only)

You can get more protection for your vehicle by purchasing a Ford Protect extended service plan. Ford Protect extended service plan is the only service contract backed by Ford Motor Company of Canada, Limited. Depending on the plan you purchase, Ford Protect extended service plan provides benefits such as:

- Rental reimbursement.
- Coverage for certain maintenance and wear items.
- Protection against repair costs after your New Vehicle Limited Warranty Coverage expires.
- Roadside Assistance benefits.

There are several Ford Protect extended service plans available in various time, distance and deductible combinations. Each plan is tailored to fit your own driving needs, including reimbursement for towing and rental. When you purchase Ford Protect extended service plan, you receive added peace-of-mind protection throughout Canada, the United States and Mexico, provided by a network of participating authorized Ford Motor Company dealers.

Note: *Repairs performed outside of Canada and the United States are not eligible for Ford Protect extended service plan coverage.*

This information is subject to change. Visit your local Ford of Canada dealer or www.ford.ca to find the Ford Protect extended service plan that is right for you.

Scheduled Maintenance

GENERAL MAINTENANCE INFORMATION

Why Maintain Your Vehicle?

Carefully following the maintenance schedule helps protect against major repair expenses resulting from neglect or inadequate maintenance and may help to increase the value of your vehicle when you sell or trade it. Keep all receipts for completed maintenance with your vehicle.

It is important that you have your vehicle serviced at the proper times. These intervals serve two purposes: first is to maintain the reliability of your vehicle and the second is to keep the cost of owning your vehicle down.

It is your responsibility to have all scheduled maintenance performed and to make sure that the materials used meet the specifications identified in this owner's manual. See **Capacities and Specifications** (page 558).

Failure to perform scheduled maintenance and regularly inspect your vehicle may result in vehicle damage not covered by the vehicle Warranty.

Why Maintain Your Vehicle at Your Dealership?

Our Genuine Replacement Parts

Dealerships stock our parts and our authorized branded re-manufactured replacement parts. These parts meet or exceed our specifications. Parts installed at your dealership carry a nationwide 24-month or unlimited mile (kilometer) parts and labor limited warranty.

If you do not use our authorized parts they may not meet our specifications and could affect emissions compliance.

Protecting Your Investment

Maintenance is an investment that pays dividends in the form of improved reliability, durability and resale value. To maintain the proper performance of your vehicle and its emission control systems, make sure you have scheduled maintenance performed at the designated intervals.

Your vehicle comes with the Intelligent Oil-Life Monitor system, a message appears in the information display at the proper oil change interval. This interval may be up to one year or 10,000 mi (16,000 km), hybrid vehicles could exceed 10,000 mi (16,000 km).

When the oil change message appears in the information display, it is time for an oil change. Make sure you perform the oil change within two weeks or 500 mi (800 km) of the message appearing. Make sure to reset the Intelligent Oil-Life Monitor after each oil change. See **Resetting the Engine Oil Change Reminder** (page 488).

If your information display resets prematurely or becomes inoperative, you should perform the oil change interval at six months or 5,000 mi (8,000 km) from your last oil change. Never exceed one year or 10,000 mi (16,000 km) between oil change intervals.

You can drive high performance vehicles in such a way that may lead to higher oil consumption including extended time at high engine speeds, high loads, engine braking, hard cornering maneuvers, track and off-road usage. Under these conditions, oil consumption of approximately 1 quart per 500 miles (1 liter per 800 km) is possible. Check the engine oil level at every refueling and adjust to maintain proper levels to avoid engine damage.

Scheduled Maintenance

It is important to rely upon your dealership to properly diagnose and repair your vehicle.

We strongly recommend only using our genuine or our authorized re-manufactured replacement parts engineered for your vehicle.

Additives and Chemicals

We do not recommend using chemicals or additives not approved by us as part of your vehicle's normal maintenance. Please consult your warranty information.

Oils, Fluids and Flushing

In many cases, fluid discoloration is a normal operating characteristic and, by itself, does not necessarily indicate a concern or that the fluid needs to be changed. Have discolored fluids that also show signs of overheating or foreign material contamination checked immediately.

Make sure to change the vehicle's oils and fluids at the specified intervals or in conjunction with a repair. Flushing is a viable way to change fluid for many vehicle sub-systems during scheduled maintenance. It is critical that systems are flushed only with new fluid that is the same as that required to fill and operate the system or using our approved flushing chemical.

Owner Checks and Services

Make sure you perform the following basic maintenance checks and inspections.

| Check Every Month |
|---|
| The engine oil level. |
| Function of all interior and the exterior lights. |
| The tires including the spare for wear and proper pressure. |
| The windshield washer fluid level. |

| Check Every Six Months |
|---|
| The battery connections. Clean if necessary. |
| The body and door drain holes for obstructions. Clean if necessary. |
| The cooling system fluid level and the coolant system strength. |
| The door weatherstrips for wear. Lubricate if necessary. |
| The hinges, latches and outside locks for proper operation. Lubricate if necessary. |
| The parking brake for proper operation. |

Scheduled Maintenance

Check Every Six Months

The seatbelts and seat latches for wear and function.

Safety warning lamps, brake, ABS, airbag and seatbelt for operation.

The washer spray and wiper operation. Clean or replace blades as necessary.

Multi-Point Inspection

It is important to have the systems on your vehicle regularly checked. This can help identify potential issues and prevent major problems. We recommend having the following multi-point inspection performed at every scheduled maintenance interval to help make sure your vehicle keeps running great.

Multi-Point Inspection

| | |
|---|---|
| Accessory drive belt or belts | Hazard warning system operation |
| Battery performance | Horn operation |
| Engine air filter | Radiator, cooler, heater and air conditioning hoses |
| Exhaust system | Suspension components for leaks or damage |
| Exterior lamps operation | Steering and linkage |
| Fluid levels ¹ ; fill if necessary | Tires including the spare for wear and proper pressure ² |
| For oil and fluid leaks | Windshield for cracks, chips or pits |
| Half-shaft dust boots | Washer spray and wiper operation |

¹ Brake, coolant recovery reservoir, automatic transmission and window washer.

² If your vehicle has a temporary mobility kit, check the tire sealant expiration Use By date on the canister. Replace as needed.

Scheduled Maintenance

Be sure to ask your dealership service advisor or technician about the multi-point vehicle inspection. It is a comprehensive way to perform a thorough inspection of your vehicle. Your checklist gives you immediate feedback on the overall condition of your vehicle.

NORMAL SCHEDULED MAINTENANCE

Oil Change Reminder

Your vehicle comes with an oil change reminder that determines when you should change the engine oil based on how you use your vehicle.

Your vehicle lets you know when an oil change is due by displaying a message in the information display.

The following table provides examples of vehicle use and its impact on oil change intervals. It is a guideline only. Actual oil change intervals depend on several factors and generally decrease with severity of use.

| When to Expect the OIL CHANGE REQUIRED Message | |
|--|--|
| Interval ¹ | Vehicle Use and Example |
| 7,500–10,000 mi (12,000–16,000 km) | Normal |
| | Normal commuting with highway driving. No, or moderate, load or towing. Flat to moderately hilly roads. No extended idling. |
| 5,000–7,500 mi (8,000–12,000 km) | Severe |
| | Moderate to heavy load or towing. Mountainous or off-road conditions. Extended idling. Extended hot or cold operation. |
| 3,000–5,000 mi (5,000–8,000 km) | Extreme |
| | Maximum load or towing. Extreme hot or cold operation. |

¹Hybrid vehicles may achieve longer distances between oil changes, but do not exceed the 1 year max oil change interval. Remaining oil life can be accessed through the information display.

Scheduled Maintenance

Normal Maintenance Intervals

| At Every Oil Change Interval as Indicated by the Information Display¹ |
|--|
| Change the engine oil and filter. ² |
| Rotate the tires, inspect for tire wear and measure the tread depth. |
| Perform a multi-point inspection, recommended. |
| Inspect the automatic transmission fluid level, if applicable with dipstick. Consult your dealer for requirements. |
| Inspect the brake pads, shoes, rotors, drums, brake linings, hoses and the parking brake. |
| Inspect the engine coolant system strength and hoses. |
| Inspect the exhaust system and heat shields. |
| Inspect the front axle and U-joints. Lubricate grease fittings if applicable. ³ |
| Inspect the half-shaft boots. |
| Inspect the steering linkage, ball joints, suspension, tire-rod ends, driveshaft and the U-joints. Lubricate any areas with grease fittings. |
| Inspect the wheels and related components for abnormal noise, wear, looseness or drag. |

¹ Do not exceed one year or 10,000 mi (16,000 km) between service intervals.

² Reset the oil change reminder after engine oil and filter changes. See **Resetting the Engine Oil Change Reminder** (page 488).

³ Four-wheel drive vehicles only.

| Brake Fluid Maintenance¹ | |
|--|--------------------------------------|
| Every 3 Years | Change the brake fluid. ² |

¹ Perform this maintenance item every 3 years. Do not exceed the designated time for the interval.

² Brake fluid servicing requires special equipment available at your authorized dealer.

Scheduled Maintenance

| Other Maintenance Items¹ | |
|--|--|
| Every 20,000 mi (32,000 km) | Replace the cabin air filter. |
| Every 30,000 mi (48,000 km) | Replace the engine air filter. |
| | Replace the engine-mounted and frame-mounted fuel filters. |
| Every 60,000 mi (96,600 km) | Replace the spark plugs. ² |
| Every 60,000 mi (96,600 km) | Inspect the accessory drive belt(s). ² |
| Every 100,000 mi (160,000 km) | Replace the accessory drive belt(s). ² |
| Every 100,000 mi (160,000 km) | Replace the spark plugs. |
| | Inspect the accessory drive belt(s). ³ |
| Every 150,000 mi (240,000 km) | Change the automatic transmission fluid and filter. |
| | Change the front axle fluid. ⁴ |
| | Change the rear axle fluid. |
| | Change the transfer case fluid. ⁴ |
| | Replace the accessory drive belt(s). |
| At 200,000 mi (322,000 km) | Change the engine coolant. ⁵ |

¹ Perform these maintenance items within 3,000 mi (4,800 km) of the last engine oil and filter change. Do not exceed the designated distance for the interval.

² Only for vehicles with pickup bed power outlet.

³ After initial inspection, inspect every other oil change until replaced.

⁴ Four-wheel drive vehicles only.

⁵ Initial replacement at 10 years or 200,000 mi (322,000 km), then every five years or 100,000 mi (160,000 km).

Scheduled Maintenance

SPECIAL OPERATING CONDITIONS SCHEDULED MAINTENANCE - GASOLINE

If you operate your vehicle primarily in any of the following conditions, you need to perform extra maintenance, as indicated. If you operate your vehicle occasionally under any of these conditions, it is not necessary to perform the extra maintenance. For specific recommendations, see your dealership service advisor or technician.

Perform the services shown in the following tables when specified or within 3,000 mi (4,800 km) of the oil change required message appearing in the information display.

- Example 1: The message comes on at 28,751 mi (46,270 km). Perform the 30,000 mi (48,000 km) automatic transmission fluid replacement.
- Example 2: The message has not come on, but the odometer reads 30,000 mi (48,000 km), for example, the oil change reminder was reset at 25,000 mi (40,000 km). Perform the engine air filter replacement.

| Towing a Trailer or Using a Car-top Carrier | |
|--|---|
| As required | Change the engine oil and filter as indicated by the information display and perform services listed in the normal scheduled maintenance chart. |
| Inspect frequently, service as required | Inspect and lubricate the U-joints. |
| | See the axle maintenance items under Exceptions. |
| Every 60,000 mi (96,000 km) | Replace the spark plugs. |

| Extensive Idling or Low-speed Driving for Long Distances, as in Heavy Commercial Use, such as Delivery, Taxi, Patrol Car or Livery | |
|---|---|
| As required | Change the engine oil and filter as indicated by the information display and perform services listed in the normal scheduled maintenance chart. |
| Inspect frequently, service as required | Replace the engine air filter. |
| Every 60,000 mi (96,000 km) | Replace the spark plugs. |

Scheduled Maintenance

| Operating in Dusty or Sandy Conditions, such as Unpaved or Dusty Roads | |
|---|--|
| Inspect frequently, service as required | Replace the engine air filter. |
| Every 5,000 mi (8,000 km) | Inspect the wheels and related components for abnormal noise, wear, looseness or drag. |
| | Rotate the tires, inspect tires for wear and measure the tread depth. |
| Every 5,000 mi (8,000 km) or six months | Change the engine oil and filter. ¹ |

¹Reset your oil change reminder after each engine oil and filter change. See **Resetting the Engine Oil Change Reminder** (page 488).

| Off-road Operation | |
|---|---|
| Inspect frequently, service as required | Inspect the steering linkage, ball joints and the U-joints. Lubricate grease fittings, if applicable. |
| | Replace the engine air filter. |
| Every 5,000 mi (8,000 km) or six months | Change the engine oil and filter. ¹ |
| | Inspect the wheels and related components for abnormal noise, wear, looseness or drag. |
| | Rotate the tires, inspect tires for wear and the measure the tread depth. |

¹Reset your oil change reminder after each engine oil and filter change. See **Resetting the Engine Oil Change Reminder** (page 488).

| Exclusive Use of E85 - Flex Fuel Vehicles Only | |
|---|--|
| Every oil change interval | If exclusively ran on E85, fill the fuel tank full with regular unleaded fuel. |

Scheduled Maintenance

| Driver Training/EVOC | |
|--|--|
| As required | Replace engine oil and filter as indicated by the information display and perform services listed in the extreme usage scheduled maintenance chart. |
| | Inspect brake pads, rotors, calipers, hoses, and service as required. |
| Inspect vehicle every day prior to starting training | Inspect engine oil level. |
| | Set tire pressure. Refer to driver door placard for cold tire pressure information. |
| | Inspect tire quality for wear. |
| | Set wheel lug nut torque. The cold wheel lug nut torque is 150 lb.ft (204 Nm). If wheels are torqued while they are hot (after 15 minutes of EVOC driving), torque may be checked to hot wheel lug nut torque of 70 lb.ft (95 Nm). |
| | Proper functioning of safety devices (seat belts, no air bag lights, etc.) |
| 25 hours of training use | Front differential/axle fluid. Check front hub / bearing bolt torque to 130 lb.ft (175 Nm). |
| 100 hours of training use | Rear differential/axle fluid. |
| Annually | Change transmission and transfer case fluids. |

Note: Follow base owner guide direction for 1,000-mile vehicle break-in prior to using vehicle for training purposes.

Note: Incorporate vehicle cool-down after hard driving.

Note: Perform Training / EVOC service according to the extreme usage scheduled maintenance chart.

Note: Use police responder part numbers for replacement parts.

Engine Idle Hour Meter

Your vehicle may have an idle meter to indicate how much time the vehicle has been sitting in park (P) or neutral (N). The meter is incorporated with the vehicle odometer. Depressing the odometer-reset button once displays the trip odometer (miles [kilometers] following by a "T" for trip odometer); depressing the odometer-reset button a second time displays the idle meter (hours following by an "H" for hours). The idle meter only accumulates time while the vehicle is in park (P) or neutral (N). Displayed time is cumulative for the vehicle and cannot be reset to zero. Police vehicles often

Scheduled Maintenance

experience long periods of idling, during which engine oil continues to break down but distance is not accumulated on the odometer. Engine Idle Hours have been incorporated into the Intelligent Oil-Life Monitor.

Exceptions

There are several exceptions to the Normal Schedule.

Axle and Transfer Case Maintenance

In four-wheel drive vehicles, axle(s) and transfer case fluid changes or level checks are not required unless a leak is suspected or the assembly has been submerged in water. Contact an authorized dealer for service.

California Fuel Filter Replacement

If you register your vehicle in California, the California Air Resources Board has determined that the failure to perform this maintenance item does not nullify the emission warranty or limit recall liability before the completion of your vehicle's useful life. Ford Motor Company urges you to have all recommended maintenance services performed at the specified intervals and to record all vehicle service.

Hot Climate Oil Change Intervals

Vehicles operating in the Middle East, North Africa, Sub-Saharan Africa or locations with similar climates using an oil that meets our specification or has an American Petroleum Institute certified for gasoline engines (certification mark) oil, the normal oil change interval is 3,000 mi (4,800 km).

Engine Air Filter Replacement

The life of the engine air filter is dependent on exposure to dusty and dirty conditions. Vehicles operated in these conditions require frequent inspection and replacement of the engine air filter.

SPECIAL OPERATING CONDITIONS SCHEDULED MAINTENANCE - RAPTOR

If you operate your vehicle primarily in any of the following conditions, you need to perform extra maintenance, as indicated. If you operate your vehicle occasionally under any of these conditions, it is not necessary to perform the extra maintenance. For specific recommendations, see your dealership service advisor or technician.

Perform the services shown in the following tables when specified or within 3,000 mi (4,800 km) of the oil change required message appearing in the information display.

- Example 1: The message comes on at 28,751 mi (46,270 km). Perform the 30,000 mi (48,000 km) automatic transmission fluid replacement.
- Example 2: The message has not come on, but the odometer reads 30,000 mi (48,000 km), for example, the oil change reminder was reset at 25,000 mi (40,000 km). Perform the engine air filter replacement.

Scheduled Maintenance

| Towing a Trailer or Using a Car-top Carrier | |
|--|---|
| As required | Change the engine oil and filter as indicated by the information display and perform services listed in the normal scheduled maintenance chart. |
| Inspect frequently, service as required | Inspect and lubricate the U-joints. |
| | See the axle maintenance items under Exceptions. |
| Every 60,000 mi (96,000 km) | Replace the spark plugs. |

| Extensive Idling or Low-speed Driving for Long Distances, as in Heavy Commercial Use, such as Delivery, Taxi, Patrol Car or Livery | |
|---|---|
| As required | Change the engine oil and filter as indicated by the information display and perform services listed in the normal scheduled maintenance chart. |
| Inspect frequently, service as required | Replace the engine air filter. |
| Every 60,000 mi (96,000 km) | Replace the spark plugs. |

| Operating in Dusty or Sandy Conditions, such as Unpaved or Dusty Roads | |
|---|--|
| Inspect frequently, service as required | Replace the engine air filter. |
| Every 5,000 mi (8,000 km) | Inspect the wheels and related components for abnormal noise, wear, looseness or drag. |
| | Rotate the tires, inspect tires for wear and measure the tread depth. |
| Every 5,000 mi (8,000 km) or six months | Change the engine oil and filter. ¹ |

¹Reset your oil change reminder after each engine oil and filter change. See **Resetting the Engine Oil Change Reminder** (page 488).

Scheduled Maintenance

Exclusive Use of E85 - Flex Fuel Vehicles Only

| | |
|---------------------------|--|
| Every oil change interval | If ran exclusively on E85, fill the fuel tank full with regular unleaded fuel. |
|---------------------------|--|

Off-Road Driving

If you operate your vehicle primarily in any of the following conditions, you need to perform extra maintenance, as indicated. If you operate your vehicle occasionally under any of these conditions, it is not necessary to perform the extra maintenance. For specific recommendations, see your dealership service advisor or technician. Examples of frequent conditions that would qualify are:

- Example 1: Continuous deep sand or dune driving for more than 25 minutes in a 4-wheel drive state using more than 50% throttle at elevated ambient temperatures (above 90°F (32°C)).
- Example 2: Continuous off-road high speed (above 55 mph (88.5 km/h) or consistently using more than 50% throttle) desert running operation for more than 60 minutes in a 4-wheel drive state at elevated ambient temperatures (above 90°F (32°C)).
- Example 3: Continuous on-road high speed driving (90 mph (145 km/h) or more) for more than 30 minutes in a 4-wheel drive state at elevated ambient temperatures (above 90°F (32°C)).

| Off-road Operation | |
|--|---|
| Inspect frequently, service as required | Inspect the steering linkage, ball joints and the U-joints. Lubricate grease fittings, if applicable. |
| | Replace the engine air filter. |
| Every 5,000 mi (8,000 km) or six months | Every 5,000 mi (8,000 km) or six months |
| | Inspect the wheels and related components for abnormal noise, wear, looseness or drag. |
| | Rotate the tires, inspect tires for wear and the measure the tread depth. |
| Every 30,000 mi (48,000 km) or two years | Change the Front Axle Fluid. |
| | Change the Transfer Case Fluid. |

¹Reset your oil change reminder after each engine oil and filter change. See **Resetting the Engine Oil Change Reminder** (page 488).

Scheduled Maintenance

Exceptions

There are several exceptions to the Normal Schedule.

Axle and Transfer Case Maintenance

In four-wheel drive vehicle's axle(s) and transfer case, fluid changes or level checks are not required unless a leak is suspected or the assembly has been submerged in water. Contact an authorized dealer for service.

California Fuel Filter Replacement

If you register your vehicle in California, the California Air Resources Board has determined that the failure to perform this maintenance item does not nullify the emission warranty or limit recall liability before the completion of your vehicle's useful life. Ford Motor Company urges you to have all recommended maintenance services performed at the specified intervals and to record all vehicle service.

Hot Climate Oil Change Intervals

Vehicles operating in the Middle East, North Africa, Sub-Saharan Africa or locations with similar climates using an oil that meets our specification or has an American Petroleum Institute certified for gasoline engines (certification mark) oil, the normal oil change interval is 3,000 mi (4,800 km).

Engine Air Filter Replacement

The life of the engine air filter is dependent on exposure to dusty and dirty conditions. Vehicles operated in these conditions require frequent inspection and replacement of the engine air filter.

Decommissioning the Vehicle - Police Responder

DECOMMISSIONING REQUIREMENTS

We have implemented a decommissioning process of manufacturer-provided police features. It is the responsibility of the owner to complete the decommissioning of the vehicle in compliance with any state regulations prior to initial sale to the public sector.

Vehicle Sealing of Aftermarket Equipment

When customized equipment has been removed from your vehicle, body panels and seals may be compromised. Thoroughly inspect your vehicle for any signs where the equipment has been removed, for example holes and damage to body seals.

Any items that remain on your vehicle must be inspected and any sign of damage repaired immediately. Failure to follow this instruction may result in water and exhaust fumes entering the passenger compartment. See your authorized dealer for more information and direction regarding proper sealing procedures.

Police Engine Idle

Authorized personnel must use a diagnostic scan tool to decommission the Police Engine Idle feature.

Pre-Collision Assist Disable

Authorized personnel must use a diagnostic scan tool to decommission the Pre-Collision Assist Disable feature.

Customer Information

ROLLOVER WARNING



WARNING: Utility vehicles have a significantly higher rollover rate than other types of vehicles.



WARNING: Vehicles with a higher center of gravity (utility and four-wheel drive vehicles) handle differently than vehicles with a lower center of gravity (passenger cars). Avoid sharp turns, excessive speed and abrupt steering in these vehicles. Failure to drive cautiously increases the risk of losing control of your vehicle, vehicle rollover, personal injury and death.



WARNING: In a rollover crash, an unbelted person is significantly more likely to die than a person wearing a seatbelt.



WARNING: Do not become overconfident in the ability of four-wheel drive vehicles. Although a four-wheel drive vehicle may accelerate better than a two-wheel drive vehicle in low traction situations, it won't stop any faster than two-wheel drive vehicles. Always drive at a safe speed.

Utility vehicles and trucks handle differently than passenger cars in the various driving conditions that are encountered on streets, highways and off-road. Utility vehicles and trucks are not designed for cornering at speeds as high as passenger cars any more than low-slung sports cars are designed to perform satisfactorily under off-road conditions.

THE BETTER BUSINESS BUREAU AUTO LINE PROGRAM

Your satisfaction is important to Ford Motor Company and to your dealer. If a warranty concern has not been resolved using the three-step procedure outlined earlier in this chapter in the Getting the Services you need section, you may be eligible to participate in the BBB AUTO LINE program.

The BBB AUTO LINE program consists of two parts – mediation and arbitration. During mediation, a representative of the BBB will contact both you and Ford Motor Company to explore options for settlement of the claim. If an agreement is not reached during mediation or you do not want to participate in mediation, and if your claim is eligible, you may participate in the arbitration process. An arbitration hearing will be scheduled so that you can present your case in an informal setting before an impartial person. The arbitrator considers the testimony provided and makes a decision after the hearing.

Disputes submitted to the BBB AUTO LINE program are usually decided within 40 days after you file your claim with the BBB. You are not bound by the decision, and may reject the decision and proceed to court where all findings of the BBB Auto Line dispute, and decision, are admissible in the court action. Should you choose to accept the BBB AUTO LINE decision, Ford is then bound by the decision, and must comply with the decision within 30 days of receipt of your acceptance letter.

BBB AUTO LINE Application: Using the information that follows, please call or write to request a program application. You will be asked for your name and address, general information about your new vehicle, information about your warranty concerns, and any steps you have

Customer Information

already taken to try to resolve them. A Customer Claim Form will be mailed that needs to be completed, signed and returned to the BBB along with proof of ownership. Upon receipt, the BBB reviews the claim for eligibility under the Program Summary Guidelines.

You can get more information by calling BBB AUTO LINE at 1-800-955-5100, or writing to:

**BBB AUTO LINE a Division of BBB National Programs, Inc.
1676 International Drive, Suite 550
McLean, VA 22102**

BBB AUTO LINE applications can also be requested by calling the Ford Motor Company Customer Relationship Center at 1-800-392-3673.

For additional information, refer to the Better Business Bureau website.

Note: *Ford Motor Company reserves the right to change eligibility limitations, modify procedures, or to discontinue this process at any time without notice and without obligation.*

THE MEDIATION AND ARBITRATION PROGRAM

For vehicles delivered to authorized Canadian dealers. In those cases where you continue to feel that the efforts by Ford of Canada and the authorized dealer to resolve a factory-related vehicle service concern have been unsatisfactory, Ford of Canada participates in an impartial third party mediation/arbitration program administered by the Canadian Motor Vehicle Arbitration Plan (CAMVAP).

The CAMVAP program is a straightforward and relatively speedy alternative to resolve a disagreement when all other efforts to produce a settlement have failed. This procedure is without cost to you and is designed to eliminate the need for lengthy and expensive legal proceedings.

In the CAMVAP program, impartial third-party arbitrators conduct hearings at mutually convenient times and places in an informal environment. These impartial arbitrators review the positions of the parties, make decisions and, when appropriate, render awards to resolve disputes. CAMVAP decisions are fast, fair, and final as the arbitrator's award is binding on both you and Ford of Canada.

CAMVAP services are available in all Canadian territories and provinces. For more information, without charge or obligation, call your CAMVAP Provincial Administrator directly at 1-800-207-0685 or visit www.camvap.ca.

ORDERING A CANADIAN FRENCH OWNER'S MANUAL

You can obtain a French owner's manual from an authorized dealer or by contacting Helm, LLC at:

HELM, LLC
47911 Halyard Drive, Suite 200
Plymouth, Michigan 48170
Attention: Customer Service

Call toll free: 1-800-782-4356

Monday-Friday 8:00 a.m. - 6:00 p.m. EST

For additional information, visit www.helminc.com.

Customer Information

REPORTING SAFETY DEFECTS IN THE UNITED STATES

If you believe that your vehicle has a defect which could cause a crash or could cause injury or death, you should immediately inform the National Highway Traffic Safety Administration (NHTSA) in addition to notifying Ford Motor Company.

If NHTSA receives similar complaints, it may open an investigation, and if it finds that a safety defect exists in a group of vehicles, it may order a recall and remedy campaign. However, NHTSA cannot become involved in individual problems between you, your dealer, or Ford Motor Company.

To contact NHTSA, you may call the Vehicle Safety Hotline toll-free at 1-888-327-4236 (TTY: 1-800-424-9153); go to www.safercar.gov; or write to:

Administrator
1200 New Jersey Avenue,
Southeast
Washington, D.C. 20590

You can also obtain other information about motor vehicle safety from www.safercar.gov.

REPORTING SAFETY DEFECTS IN CANADA

If you believe that your vehicle has a defect which could cause a crash or could cause injury or death, you should immediately inform Transport Canada and Ford of Canada.

| Transport Canada Contact Information | |
|--------------------------------------|---|
| Website (English) | http://tc.canada.ca/recalls |
| Website (French) | http://tc.canada.ca/rappels |
| Phone | 1-800-333-0510 |

| Ford of Canada Contact Information | |
|------------------------------------|--|
| Website | www.ford.ca |
| Phone | 1-800-565-3673 |

Customer Information

RADIO FREQUENCY CERTIFICATION LABELS

BLIND SPOT INFORMATION SYSTEM SENSORS

Argentina



Europe Union EU

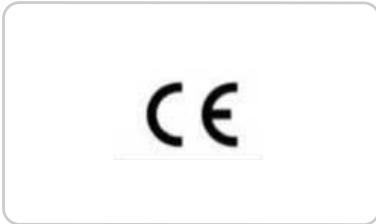

Ghana

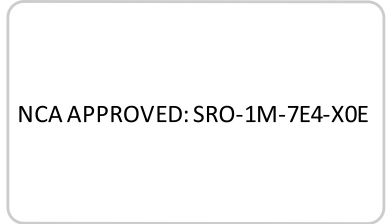

Jamaica

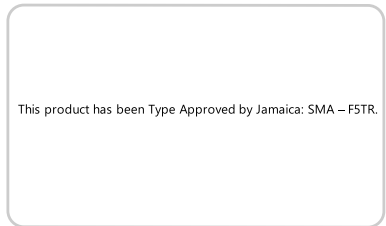

Paraguay



2020-10-I-0753

Customer Information

South Korea



R-C-1Ap-F5TR

Taiwan

CCA I 20LP 1990T7

United Arab Emirates (U.A.E.)

TRA
REGISTERED NO: ER80144/20
DEALER NO: DA83047/19

United States and Canada



WARNING: Changes or modifications not expressly approved by the party responsible for compliance could void the user's authority to operate the equipment. The term "IC:" before the radio certification number only signifies that Industry Canada technical specifications were met.

FCC ID: L2CF5TR

IC: 3432A-F5TR

This device complies with Part 15 of the FCC Rules and with Innovation, Science and Economic Development Canada's licence-exempt RSS(s). Operation is subject to the following two conditions:

1. This device may not cause harmful interference, and
2. This device must accept any interference received, including interference that may cause undesired operation.

BODY CONTROL MODULE

Argentina

CNC COMISIÓN NACIONAL
DE COMUNICACIONES

CNC ID: H-23804

Customer Information

Brazil



Moldova



Ghana

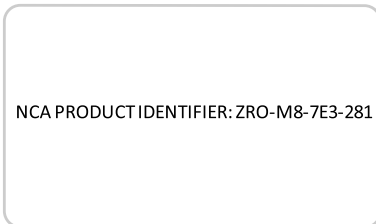

Morocco



Jamaica

This product has been Type Approved by Jamaica: SMA - M3NA2C766336.

Paraguay



2019-01-I-000076

Customer Information

Serbia



U011 20

Ukraine



UA.TR.028

Singapore

Complies with IMDA Standards

DA 00461

United Arab Emirates (U.A.E.)

TRA
REGISTERED No: ER68566/19
DEALER No: DA37380/15

South Africa



United States and Canada



WARNING: Changes or modifications not expressly approved by the party responsible for compliance could void the user's authority to operate the equipment. The term "IC:" before the radio certification number only signifies that Industry Canada technical specifications were met.

FCC ID: M3NA2C766336

IC: 7812A-A2C766336

Customer Information

This device complies with Part 15 of the FCC Rules and with Innovation, Science and Economic Development Canada's licence-exempt RSS(s). Operation is subject to the following two conditions:

1. This device may not cause harmful interference, and
2. This device must accept any interference received, including interference that may cause undesired operation.

Vietnam

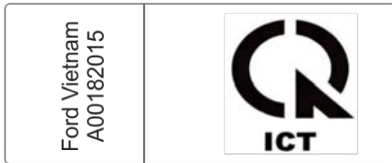

Zambia



CRUISE CONTROL MODULE

Argentina



Djibouti

AGREE PAR LE MCPT (REPUBLIQUE DE DJIBOUTI)
Numéro d'agrément : 059/DDTIC/2020
Date d'agrément : 01/10/2020

Europe Union EU

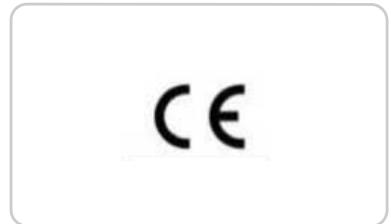

Customer Information

Ghana

NCA APPROVED: SRO-1M-7E4-X13

Paraguay



Jamaica

This product has been Type Approved by Jamaica: SMA – F3TR.

2020-10-I-0752

South Korea



Mauritania

AGREE PAR L'ANE MAURITANIE
Numéro d'agrément : 0835/ARE/2020
Date d'agrément : 31/08/2020

R-C-1Ap-F3TR

Taiwan



Customer Information

Unites Arab Emirates (U.A.E.)

TRA
REGISTERED NO: ER80143/20
DEALER NO: DA83047/19

Zambia



United States and Canada



WARNING: Changes or modifications not expressly approved by the party responsible for compliance could void the user's authority to operate the equipment. The term "IC:" before the radio certification number only signifies that Industry Canada technical specifications were met.

FCC ID: L2CF3TR

IC: 3432A-F3TR

This device complies with Part 15 of the FCC Rules and with Innovation, Science and Economic Development Canada's licence-exempt RSS(s). Operation is subject to the following two conditions:

1. This device may not cause harmful interference, and
2. This device must accept any interference received, including interference that may cause undesired operation.

KEYS AND REMOTE CONTROLS

Argentina

CNC: H-16366

CNC COMISIÓN NACIONAL
DE COMUNICACIONES

CNC: H-24101

CNC COMISIÓN NACIONAL
DE COMUNICACIONES

Customer Information

Brazil



Jamaica

This product has been Type Approved by Jamaica: SMA – M3N-A2C931423



Paraguay



European Union EU



NR: 2017-10-I-0000334

NR: 2018-07-I-000317

NR: 2016-9-I-000220

NR: 2016-9-I-000223

Customer Information

Pakistan

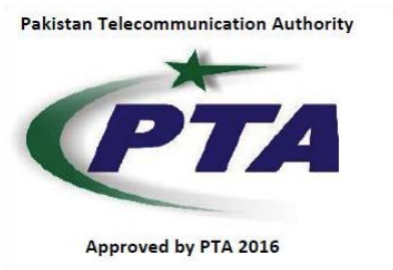

 CCAB16LP284DT9

United Arab Emirates (U.A.E.)



TRA
REGISTERED No:
ER37535/15

DEALER No:
DA37380/15

Taiwan

 CCAB16LP284CT7

TRA
REGISTERED NO: ER49357/16
DEALER NO: DA37380/15

Customer Information

TRA
REGISTERED No: ER47690/16
DEALER No: DA37380/15

TRA
REGISTERED NO: ER46754/16
DEALER NO: DA37380/15

IC: 7812A-A3C054338
IC: 7812A-A3C054339
IC: 3248A-A08TAA
IC: 7812A-A2C931423
IC: 7812A-A2C931426

This device complies with Part 15 of the FCC Rules and with Innovation, Science and Economic Development Canada's licence-exempt RSS(s). Operation is subject to the following two conditions:

1. This device may not cause harmful interference, and
2. This device must accept any interference received, including interference that may cause undesired operation.

PASSIVE ANTI-THEFT SYSTEM

Argentina

United States and Canada

 **WARNING:** Changes or modifications not expressly approved by the party responsible for compliance could void the user's authority to operate the equipment. The term "IC:" before the radio certification number only signifies that Industry Canada technical specifications were met.

FCC ID: M3N-A3C054338
FCC ID: M3N-A3C054339
FCC ID: N5F-A08TAA
FCC ID: N5F-A08TDA
FCC ID: M3N-A2C931423
FCC ID: M3N-A2C931426

CNC: H-20727

 **COMISIÓN NACIONAL
DE COMUNICACIONES**

Customer Information

Brazil



0106-14-03199

Este equipamento opera em caráter secundário, isto é, não tem direito a proteção contra interferência prejudicial, mesmo de estações do mesmo tipo, e não pode causar interferência a sistemas operando em caráter primário.

Canada and United States of America



WARNING: Changes or modifications not expressly approved by the party responsible for compliance could void the user's authority to operate the equipment. The term "IC:" before the radio certification number only signifies that Industry Canada technical specifications were met.

FCC ID: OUC11545917

IC: 850K-11545917

This device complies with Part 15 of the FCC Rules and with Innovation, Science and Economic Development Canada's licence-exempt RSS(s). Operation is subject to the following two conditions:

1. This device may not cause harmful interference, and
2. This device must accept any interference received, including interference that may cause undesired operation.

Djibouti

AGREE PAR LE MCPT (REPUBLIQUE DE DJIBOUTI)
Numéro d'agrément: 243/MCPT/SC/16
Date d'agrément: 23/05/16

Ghana

NCA APPROVED: NCA/TA/16/22

Indonesia

SERTIFIKAT NOMOR: 44714/SDPPI/2016
PLG ID: 4941

Customer Information

Jamaica

This product has been Type Approved by Jamaica: SMA- OUC11545917

Moldova



Malaysia



CIDF18000209

Morocco

AGREE PAR L'ANRT MAROC
Numéro d'agrément: MR 8922 ANRT 2014
Date d'agrément: 04/02/2014

Mauritania

AGREE PAR L'ANEMAURITANIE
Numéro d'agrément: 0231/ARE/2014
Date d'agrément: 14/11/2014

Pakistan



Customer Information

Paraguay

NR: 2017-09-10000292



South Africa

TA-2013/1617

APPROVED



Serbia



И011 16

South Korea



MSIP-RRM-OAC-OUC11541917

Singapore

Complies with IMDA Standards

DA 00461

Syria

SyTRA

REGISTERED No:
1510/4NK

Customer Information

Taiwan, China

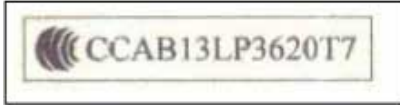

Vietnam



Ukraine



RADIO TRANSCEIVER MODULE

Argentina



United Arab Emirates (U.A.E.)

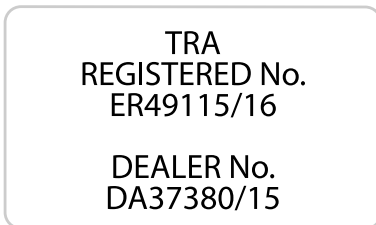

Brazil



Customer Information

Djibouti

AGREE PAR LE MCPT (REPUBLIQUE DE DJIBOUTI)
Numéros d'agrément : 033/DDTIC/2020
Date d'agrément : 07/06/2020

AGREE PAR LE MCPT (REPUBLIQUE DE DJIBOUTI)
Numéros d'agrément : 034/DDTIC/2020
Date d'agrément : 07/06/2020

AGREE PAR L'ANE MAURITANIE
Numéro d'agrément : 0802/ARE/2020
Date d'agrément : 03/06/2020

Ghana

NCA APPROVED: SRO-1M-7E4-108

NCA APPROVED: SRO-1M-7E4-114

Morocco

AGREE PAR L'ANE MAROC
Numéro d'agrément : MR 24102 ANRT 2020
Date d'agrément : 18/05/2020

Mauritania

AGREE PAR L'ANE MAURITANIE
Numéro d'agrément: 0803/ARE/2020
Date d'agrément: 03/06/2020

Pakistan



Customer Information

South Africa



United Arab Emirates (U.A.E.)

TRA
REGISTERED No:
ER81341/20

DEALER No:
DA88113/20

TRA
REGISTERED No:
ER81342/20

DEALER No:
DA88113/20

United States and Canada



WARNING: Changes or modifications not expressly approved by the party responsible for compliance could void the user's authority to operate the equipment. The term "IC:" before the radio certification number only signifies that Industry Canada technical specifications were met.

FCC ID: L2C0082R

FCC ID: L2C0083TR

IC: 342A-0083TR

This device complies with Part 15 of the FCC Rules and with Innovation, Science and Economic Development Canada's licence-exempt RSS(s). Operation is subject to the following two conditions:

1. This device may not cause harmful interference, and
2. This device must accept any interference received, including interference that may cause undesired operation.

Zambia



Customer Information

SYNC

Argentina



08658-19-01505

Este equipamento não tem direito à proteção contra interferência prejudicial e não pode causar interferência em sistemas devidamente autorizados.



Djibouti

AGREE PAR LE MCPT (REPUBLIQUE DE DJIBOUTI)

Numéro d'agrément : 124/DDTIC/2019

Date d'agrément : 07/08/2019

Brazil



08657-19-01505

AGREE PAR LE MCPT (REPUBLIQUE DE DJIBOUTI)

Numéro d'agrément : 125/DDTIC/2019

Date d'agrément : 07/08/2019

Este equipamento não tem direito à proteção contra interferência prejudicial e não pode causar interferência em sistemas devidamente autorizados.

Customer Information

European Union EU

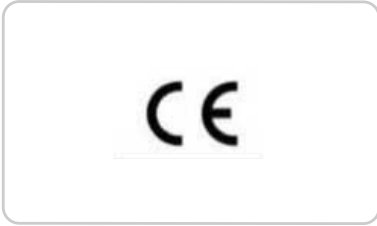

Ghana

NCA APPROVED: ZRO-1H-7E3-182

NCA APPROVED: ZRO-1H-7E3-180

Jamaica

This product has been Type Approved by
Jamaica: SMA – SYNC-G4.

Malaysia



SQASI/TA/19/4047

SQASI/TA/19/4046

Mauritania

AGREE PAR L'ANE MAURITANIE
Numéro d'agrément : 0692/ARE/2018
Date d'agrément : 08/08/2019

Customer Information

AGREE PAR L'ANE MAURITANIE
Numéro d'agrément : 0691/ARE/2018
Date d'agrément : 08/08/2019

AGREE PAR L'ANRT MAROC
N° D'AGRÉMENT: MR 20606 ANRT 2019
07 AOUT 2019

Moldova



Pakistan



Morocco

AGREE PAR L'ANRT MAROC
N° D'AGRÉMENT: MR 20608 ANRT 2019
07 AOUT 2019

Paraguay



2020-03-I-00192

2020-03-I-00193

Customer Information

Serbia



W005 20

TA-2019/2466



Singapore

Complies with IMDA Standards

DA 00461

South Korea



MSIP-R-C-FDM-SYNGG4



MSIP-R-C-FDM-SYNGG4L

South Africa

TA-2019/2465



Taiwan

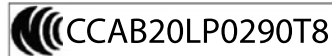

Customer Information



CCAB20LP0300T1

TRA

REGISTERED No: ER74903/19

DEALER No: DA37380/15

Ukraine



United States and Canada

 **WARNING:** Changes or modifications not expressly approved by the party responsible for compliance could void the user's authority to operate the equipment. The term "IC:" before the radio certification number only signifies that Industry Canada technical specifications were met.

FCC ID: KMH-SYNCG4

FCC ID: KMH-SYNCG4L

IC: 1422A-SYNCG4

IC: 1422A-SYNCG4L

This device complies with Part 15 of the FCC Rules and with Innovation, Science and Economic Development Canada's licence-exempt RSS(s). Operation is subject to the following two conditions:

1. This device may not cause harmful interference, and
2. This device must accept any interference received, including interference that may cause undesired operation.

United Arab Emirates (U.A.E.)



Customer Information

Zambia



Brazil



05160-16-08001

Este equipamento opera em caráter secundário, isto é, não tem direito a proteção contra interferência prejudicial, mesmo de estações do mesmo tipo, e não pode causar interferência a sistemas operando em caráter primário.

Jamaica



This product has been Type Approved by Jamaica: SMA – FP3

**TIRE PRESSURE MONITORING
SYSTEM SENSORS - VEHICLES
WITH: 315 MHZ SENSORS**

Argentina



Mexico

IFT: RLVSCFP16-1400
"La operación de este equipo está sujeta a las siguientes dos condiciones:
(1) es posible que este equipo o dispositivo no cause interferencia perjudicial y
(2) este equipo o dispositivo debe aceptar cualquier interferencia, incluyendo la que pueda causar su operación no deseada."

Customer Information

Paraguay



TIRE PRESSURE MONITORING SYSTEM SENSORS - VEHICLES WITH: 433 MHZ SENSORS

Argentina



United States and Canada

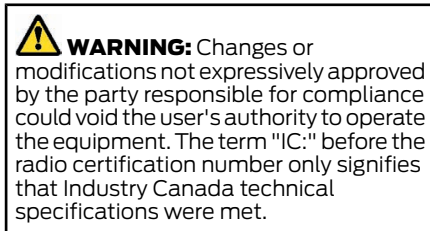

FCC ID: MRXFP3

IC: 2546A-FP3

This device complies with Part 15 of the FCC Rules and with Innovation, Science and Economic Development Canada's licence-exempt RSS(s). Operation is subject to the following two conditions:

1. This device may not cause harmful interference, and
2. This device must accept any interference received, including interference that may cause undesired operation.

China

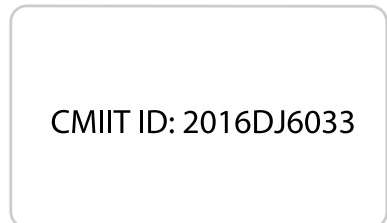

Customer Information

Djibouti

AGREE PAR LE MCPT
(REPUBLIQUE DE DJIBOUTI)
Numéro d'agrément : 547/MCPT/DPT/16
Date d'agrément : 27/09/16

Mauritania

AGREE PAR L'ANE MAURITANIE
Numéro d'agrément : 0358/ARE/2016
Date d'agrément : 04/10/2016

Ghana

NCA APPROVED: 2R9-8M-7E0-0BE

Jordan

Model: FP4
Manufacturer: Schrader Electronics Ltd
Type Approval No: TRC/LPD/2017/360
Equipment Type: Low Power Device (LPD)

Moldova



Nigeria

Connection and use of this
communications
equipment is permitted by the Nigerian
Communications Commission

Customer Information

Oman

OMAN TRA
TA-R/3591/16
D080134

Pakistan

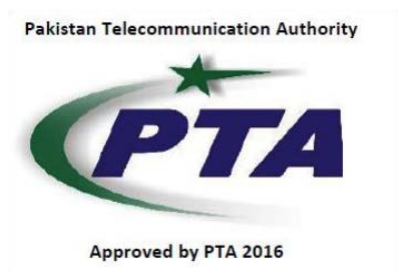

Paraguay



Serbia

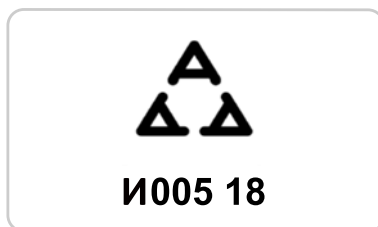

Singapore

Complies with
IMDA Standards
DA 107968

South Korea



Ukraine



Customer Information

United Arab Emirates

TRA
REGISTERED No:
ER48598/16

DEALER No.
DA0047074

Djibouti

AGREE PAR LE MCPT (REPUBLIQUE DE DJIBOUTI)
Numéro d'agrément : 004/DDTIC/2019
Date d'agrément : 10/01/2019

WIRELESS ACCESSORY CHARGING MODULE

Argentina

CNC COMISIÓN NACIONAL
DE COMUNICACIONES

CNC ID: H-21576

European Union EU

CE

Ghana

NCA APPROVED: 1R3-1M-7E1-174

Brazil

 **ANATEL**

Agência Nacional de Telecomunicações

04021-18-06661

Jamaica

This product has been Type Approved
by Jamaica: SMA - WACM.

Customer Information

Jordan

Type Approval No: TRC/LPD/2017/418
Equipment Type: Low Power Device (LPD)

Malaysia



SQASI/TA/19/4129

Mauritania

AGREE PAR L'ANE MAURITANIE
Numéro d'agrément : 0474/ARE/2018
Date d'agrément : 05/03/2018

Moldova



Morocco

AGREE PAR L'ANRT MAROC
Numéro d'agrément : MR 15474 ANRT 2017
Date d'agrément : 25/12/2017

Paraguay



2017-10-I-0000333

Customer Information

Serbia



N011 18

South Korea



R-RMM-DLH-WACM

Singapore

Complies with IMDA Standards

DA 00461

Taiwan, China



CCAH17LP1930T0

South Africa



Ukraine



UA.TR.028

Customer Information

United Arab Emirates (U.A.E.)

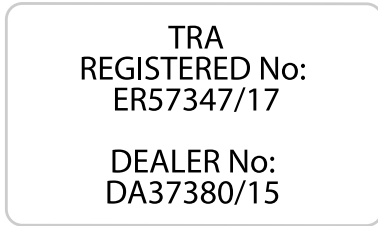

Vietnam



United States and Canada

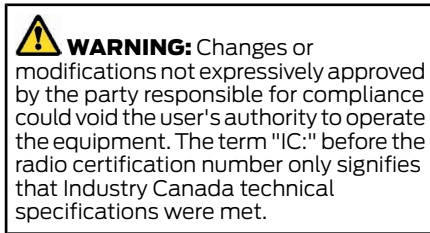

FCC ID: L2C0066T

This device complies with Part 15 of the FCC Rules and with Innovation, Science and Economic Development Canada's licence-exempt RSS(s). Operation is subject to the following two conditions:

1. This device may not cause harmful interference, and
2. This device must accept any interference received, including interference that may cause undesired operation.

Zambia



PERCHLORATE

Certain components in your vehicle such as airbag modules, seatbelt pretensioners and remote control batteries may contain perchlorate material. Special handling may apply for service or vehicle end of life disposal.

For more information visit:
www.dtsc.ca.gov/hazardouswaste/perchlorate.

Customer Information

REPLACEMENT PARTS RECOMMENDATION

We have built your vehicle to the highest standards using quality parts. We recommend that you demand the use of genuine Ford and Motorcraft parts whenever your vehicle requires scheduled maintenance or repair. You can clearly identify genuine Ford and Motorcraft parts by looking for the Ford, FoMoCo or Motorcraft branding on the parts or their packaging.

Scheduled Maintenance and Mechanical Repairs

One of the best ways for you to make sure that your vehicle provides years of service is to have it maintained in line with our recommendations using parts that conform to the specifications detailed in this Owner's Manual.

Genuine Ford and Motorcraft parts meet or exceed these specifications.

Collision Repairs

We hope that you never experience a collision, but accidents happen sometimes.

Genuine Ford replacement collision parts meet our stringent requirements for fit, finish, structural integrity, corrosion protection and dent resistance. During vehicle development we validate that these parts deliver the intended level of protection as a whole system. A great way to know for sure you are getting this level of protection is to use genuine Ford replacement collision parts.

Warranty on Replacement Parts

Genuine Ford and Motorcraft replacement parts are the only replacement parts that benefit from a Ford Warranty.

The Ford Warranty may not cover damage caused to your vehicle as a result of failed non-Ford parts.

For additional information, refer to the terms and conditions of the Ford Warranty.

MOBILE COMMUNICATIONS EQUIPMENT



WARNING: Driving while distracted can result in loss of vehicle control, crash and injury. We strongly recommend that you use extreme caution when using any device that may take your focus off the road. Your primary responsibility is the safe operation of your vehicle. We recommend against the use of any hand-held device while driving and encourage the use of voice-operated systems when possible. Make sure you are aware of all applicable local laws that may affect the use of electronic devices while driving.

Using mobile communications equipment is becoming increasingly important in the conduct of business and personal affairs. However, you must not compromise your own or others' safety when using such equipment. Mobile communications can enhance personal safety and security when appropriately used, particularly in emergency situations. Safety must be paramount when using mobile communications equipment to avoid negating these benefits. Mobile communication equipment includes, but is not limited to, cellular phones, pagers, portable email devices, text messaging devices and portable two-way radios.

Customer Information

END USER LICENSE AGREEMENT

VEHICLE SOFTWARE END USER LICENSE AGREEMENT (EULA)

- You ("You" or "Your" as applicable) have acquired a vehicle having several devices, including SYNC ® and various control modules, ("DEVICES") that include software licensed or owned by Ford Motor Company and its affiliates ("FORD MOTOR COMPANY"). Those software products of FORD MOTOR COMPANY origin, as well as associated media, printed materials, and "online" or electronic documentation ("SOFTWARE") are protected by international intellectual property laws and treaties. The SOFTWARE is licensed, not sold. All rights reserved.
- The SOFTWARE may interface with and/or communicate with, or may be later upgraded to interface with and/or communicate with additional software and/or systems provided by FORD MOTOR COMPANY.

IF YOU DO NOT AGREE TO THIS END USER LICENSE AGREEMENT ("EULA") DO NOT USE THE DEVICES OR COPY THE SOFTWARE. ANY USE OF THE SOFTWARE, INCLUDING BUT NOT LIMITED TO USE ON THE DEVICES, WILL CONSTITUTE YOUR AGREEMENT TO THIS EULA (OR RATIFICATION OF ANY PREVIOUS CONSENT).

GRANT OF SOFTWARE LICENSE: This EULA grants you the following license:

- You may use the SOFTWARE as installed on the DEVICES and as otherwise interfacing with systems and/or services provide by or through FORD MOTOR COMPANY or its third party software and service providers.

Description of Other Rights and Limitations.

- **Speech Recognition:** If the SOFTWARE includes speech recognition component(s), you should understand that speech recognition is an inherently statistical process and that recognition errors are inherent in the process. Neither FORD MOTOR COMPANY nor its suppliers shall be liable for any damages arising out of errors in the speech recognition process. It is your responsibility to monitor any speech recognition functions included in the system.
- **Limitations on Reverse Engineering, Decompilation and Disassembly:** You may not reverse engineer, decompile, translate, disassemble or attempt to discover any source code or underlying ideas or algorithms of the SOFTWARE nor permit others to reverse engineer, decompile or disassemble the SOFTWARE, except and only to the extent that such activity is expressly permitted by applicable law notwithstanding this limitation or to the extent as may be permitted by the licensing terms governing use of any open source components included with the SOFTWARE.
- **Limitations on Distributing, Copying, Modifying and Creating Derivative Works:** You may not distribute, copy, make modifications to or create derivative works based on the SOFTWARE, except and only to the extent that such activity is expressly permitted by applicable law notwithstanding this limitation or to the extent as may be permitted by the licensing terms governing use of any open source components included with the SOFTWARE.

Customer Information

- **Single EULA:** The end user documentation for the DEVICES and related systems and services may contain multiple EULAs, such as multiple translations and/or multiple media versions (e.g., in the user documentation and in the software). Even if you receive multiple EULAs, you are licensed to use only one (1) copy of the SOFTWARE.
- **SOFTWARE Transfer:** You may permanently transfer your rights under this EULA only as part of a sale or transfer of the DEVICES, provided you retain no copies, you transfer all of the SOFTWARE (including all component parts, the media and printed materials, any upgrades, and, if applicable, the Certificate(s) of Authenticity), and the recipient agrees to the terms of this EULA. If the SOFTWARE is an upgrade, any transfer must include all prior versions of the SOFTWARE.
- **Termination:** Without prejudice to any other rights, FORD MOTOR COMPANY may terminate this EULA if you fail to comply with the terms and conditions of this EULA.
- **Internet-Based Services Components:** The SOFTWARE may contain components that enable and facilitate the use of certain Internet-based services. You acknowledge and agree that FORD MOTOR COMPANY, third party software and service suppliers, its affiliates and/or its designated agent may automatically check the version of the SOFTWARE and/or its components that you are utilizing and may provide upgrades or supplements to the SOFTWARE that may be automatically downloaded to your DEVICES.
- **Additional Software/Services:** The SOFTWARE may permit FORD MOTOR COMPANY, third party software and service suppliers, its affiliates and/or its designated agent to provide or make available to you SOFTWARE updates, supplements, add-on components, or Internet-based services components of the SOFTWARE after the date you obtain your initial copy of the SOFTWARE ("Supplemental Components".) SOFTWARE updates may cause you to incur additional charges from your wireless service provider. If FORD MOTOR COMPANY or third party software and services suppliers provide or make available to you Supplemental Components and no other EULA terms are provided along with the Supplemental Components, then the terms of this EULA shall apply. FORD MOTOR COMPANY, its affiliates and/or its designated agent reserve the right to discontinue without liability any Internet-based services provided to you or made available to you through the use of the SOFTWARE.

Customer Information

- **Links to Third Party Sites:** The SOFTWARE may provide you with the ability to link to third party sites. The third party sites are not under the control of FORD MOTOR COMPANY, its affiliates and/or its designated agent. Neither FORD MOTOR COMPANY nor its affiliates nor its designated agent are responsible for (i) the contents of any third party sites, any links contained in third party sites, or any changes or updates to third party sites, or (ii) webcasting or any other form of transmission received from any third party sites. If the SOFTWARE provides links to third party sites, those links are provided to you only as a convenience, and the inclusion of any link does not imply an endorsement of the third party site by FORD MOTOR COMPANY, its affiliates and/or its designated agent.
- **Obligation to Drive Responsibly:** You recognize your obligation to drive responsibly and keep attention on the road. You will read and abide with the DEVICES operating instructions particularly as they pertain to safety and you agree to assume any risk associated with the use of the DEVICES.

UPGRADES AND RECOVERY MEDIA:

If the SOFTWARE is provided by FORD MOTOR COMPANY separate from the DEVICES on media such as a ROM chip, CD ROM disk(s) or via web download or other means, and is labeled "For Upgrade Purposes Only" or "For Recovery Purposes Only" you may install one (1) copy of such SOFTWARE onto the DEVICES as a replacement copy for the existing SOFTWARE, and use it in accordance with this EULA, including any additional EULA terms accompanying the upgrade SOFTWARE.

INTELLECTUAL PROPERTY RIGHTS:

All title and intellectual property rights in and to the SOFTWARE (including but not limited to any images, photographs, animations, video, audio, music, text and "applets" incorporated into the SOFTWARE), the accompanying printed materials, and any copies of the SOFTWARE, are owned by FORD MOTOR COMPANY, or its affiliates or suppliers. The SOFTWARE is licensed, not sold. You may not copy the printed materials accompanying the SOFTWARE. All title and intellectual property rights in and to the content which may be accessed through use of the SOFTWARE is the property of the respective content owner and may be protected by applicable copyright or other intellectual property laws and treaties. This EULA grants you no rights to use such content outside its intended use. All rights not specifically granted under this EULA are reserved by FORD MOTOR COMPANY, its affiliates, and third party software and service providers and suppliers. Use of any on-line services which may be accessed through the SOFTWARE may be governed by the respective terms of use relating to such services. If this SOFTWARE contains documentation that is provided only in electronic form, you may print one copy of such electronic documentation.

EXPORT RESTRICTIONS: You acknowledge that the SOFTWARE is subject to U.S. and European Union export jurisdiction. You agree to comply with all applicable international and national laws that apply to the SOFTWARE, including the U.S. Export Administration Regulations, as well as end-user, end-use and destination restrictions issued by U.S. and other governments.

Customer Information

TRADEMARKS: This EULA does not grant you any rights in connection with any trademarks or service marks of FORD MOTOR COMPANY, its affiliates, and third party software and service providers.

PRODUCT SUPPORT: Please refer to FORD MOTOR COMPANY instructions provided in the documentation for the DEVICES product support, such as the vehicle owner guide.

Should you have any questions concerning this EULA, or if you desire to contact FORD MOTOR COMPANY for any other reason, please refer to the address provided in the documentation for the DEVICES.

No Liability for Certain Damages: EXCEPT AS PROHIBITED BY LAW, FORD MOTOR COMPANY, ANY THIRD PARTY SOFTWARE OR SERVICES SUPPLIERS, AND THEIR AFFILIATES SHALL HAVE NO LIABILITY FOR ANY INDIRECT, SPECIAL, CONSEQUENTIAL OR INCIDENTAL DAMAGES ARISING FROM OR IN CONNECTION WITH THE USE OR PERFORMANCE OF THE SOFTWARE. THIS LIMITATION SHALL APPLY EVEN IF ANY REMEDY FAILS OF ITS ESSENTIAL PURPOSE. THERE ARE NO WARRANTIES OTHER THAN THOSE THAT MAY BE EXPRESSLY PROVIDED FOR YOUR NEW VEHICLE.

SYNC® Automotive Important Safety Information Read and follow instructions:

- Before using your SYNC® system, read and follow all instructions and safety information provided in this end user manual ("Owner Guide".) Not following precautions found in the Owner Guide can lead to an accident or other serious injuries.

General Operation

- **Voice Command Control:** Certain functions within the SYNC® system may be accomplished using voice commands. Using voice commands while driving helps you to operate the system without removing your hands from the wheel or eyes from the road.
- **Prolonged Views of Screen:** Do not access any function requiring a prolonged view of the screen while you are driving. Pull over in a safe and legal manner before attempting to access a function of the system requiring prolonged attention.
- **Volume Setting:** Do not raise the volume excessively. Keep the volume at a level where you can still hear outside traffic and emergency signals while driving. Driving while unable to hear these sounds could cause an accident.
- **Navigation Features:** Any navigation features included in the system are intended to provide turn by turn instructions to get you to a desired destination. Please make certain all persons using this system carefully read and follow instructions and safety information fully.
- **Distraction Hazard:** Any navigation features may require manual (non-verbal) setup. Attempting to perform such set-up or insert data while driving can distract your attention and could cause an accident or other serious injury. Stop the vehicle in a safe and legal manner before attempting these operations.
- **Let Your Judgment Prevail:** Any navigation features are provided only as an aid. Make your driving decisions based on your observations of local conditions and existing traffic regulations. Any such feature is not a

Customer Information

substitute for your personal judgment. Any route suggestions made by this system should never replace any local traffic regulations or your personal judgment or knowledge of safe driving practices.

- **Route Safety:** Do not follow the route suggestions if doing so would result in an unsafe or illegal maneuver, if you would be placed in an unsafe situation, or if you would be directed into an area that you consider unsafe. The driver is ultimately responsible for the safe operation of the vehicle and therefore, must evaluate whether it is safe to follow the suggested directions.
- **Potential Map Inaccuracy:** Maps used by this system may be inaccurate because of changes in roads, traffic controls or driving conditions. Always use good judgment and common sense when following the suggested routes.
- **Emergency Services:** Do not rely on any navigation features included in the system to route you to emergency services. Ask local authorities or an emergency services operator for these locations. Not all emergency services such as police, fire stations, hospitals and clinics are likely to be contained in the map database for such navigation features.

Your Responsibilities and Assumptions of Risk

- You agree to each of the following: (a) Any use of the SOFTWARE while driving an automobile or other vehicle in violation of applicable law or otherwise driving in an unsafe manner presents a significant risk of distracted driving and should not be attempted under any circumstances; (b) Use of the SOFTWARE at excessive volume poses a significant risk of hearing damage and should not be attempted under any circumstances; (c) The SOFTWARE may not be compatible with new or different versions of an operating system, third party software, or third party services, and the SOFTWARE may potentially cause a critical failure of an operating system, third party software, or third party service. (d) Any third party service accessed by or third party software used with the SOFTWARE (i) may charge an additional fee for access, (ii) may not work correctly, on an uninterrupted basis, or error free, (iii) may change streaming formats or discontinue operation, (iv) may contain adult, profane or offensive content; and (v) may contain inaccurate, false or misleading traffic, weather, financial or safety information or other content; and (e) Use of the SOFTWARE may cause you to incur additional charges from your wireless service provider (WSP) and any data or minute calculators that may be included in the software program are for reference only, are not warranted in any way and should not be relied upon in anyway.
- When using the SOFTWARE, you agree to be responsible for and assume the entire risk to the items set forth in Section (a) – (e) above.

Customer Information

Disclaimer of Warranty

YOU EXPRESSLY ACKNOWLEDGE AND AGREE THAT USE OF THE DEVICES AND SOFTWARE IS AT YOUR SOLE RISK AND THAT THE ENTIRE RISK AS TO SATISFACTORY QUALITY, PERFORMANCE, COMPATIBILITY, ACCURACY AND EFFORT IS WITH YOU. TO THE MAXIMUM EXTENT PERMITTED BY APPLICABLE LAW, THE SOFTWARE AND ANY THIRD PARTY SOFTWARE OR THIRD-PARTY SERVICES ARE PROVIDED "AS IS" AND "AS AVAILABLE", WITH ALL FAULTS AND WITHOUT WARRANTY OF ANY KIND, AND FORD MOTOR COMPANY HEREBY DISCLAIMS ALL WARRANTIES AND CONDITIONS WITH RESPECT TO THE SOFTWARE, THIRD PARTY SOFTWARE, AND THIRD-PARTY SERVICES, EITHER EXPRESS, IMPLIED OR STATUTORY, INCLUDING, BUT NOT LIMITED TO, THE IMPLIED WARRANTIES AND/OR CONDITIONS OF MERCHANTABILITY, OF SATISFACTORY QUALITY, OF FITNESS FOR AN PARTICULAR PURPOSE, OF ACCURACY, OF QUIET ENJOYMENT, AND NON-INFRINGEMENT OF THIRD-PARTY RIGHTS. FORD MOTOR COMPANY DOES NOT WARRANT (a) AGAINST INTERFERENCE WITH YOUR ENJOYMENT OF THE SOFTWARE, THIRD PARTY SOFTWARE, OR THIRD-PARTY SERVICES, (b) THAT THE SOFTWARE, THIRD PARTY SOFTWARE, OR THIRD-PARTY SERVICES WILL MEET YOUR REQUIREMENTS, (c) THAT THE OPERATION OF THE SOFTWARE, THIRD PARTY SOFTWARE, OR THIRD-PARTY SERVICES WILL BE UNINTERRUPTED OR ERROR-FREE, (d) OR THAT DEFECTS IN THE SOFTWARE, THIRD PARTY SOFTWARE, OR THIRD-PARTY SERVICES WILL BE CORRECTED. NO ORAL OR WRITTEN INFORMATION OR ADVICE GIVEN BY FORD MOTOR COMPANY OR ITS AUTHORIZED REPRESENTATIVE SHALL

CREATE A WARRANTY. SHOULD THE SOFTWARE, THIRD PARTY SOFTWARE, OR THIRD-PARTY SERVICES PROVE DEFECTIVE, YOU ASSUME THE ENTIRE COST OF ALL NECESSARY SERVICING, REPAIR OR CORRECTION. SOME JURISDICTIONS DO NOT ALLOW THE DISCLAIMER OF IMPLIED WARRANTIES OR LIMITATIONS ON APPLICABLE STATUTORY RIGHTS OF A CONSUMER, SO THE ABOVE DISCLAIMER MAY NOT FULLY APPLY TO YOU. THE SOLE WARRANTY PROVIDED BY FORD MOTOR COMPANY SHALL BE FOUND IN THE WARRANTY INFORMATION INCLUDING WITH YOUR OWNER GUIDE. TO THE EXTENT THAT THERE IS ANY CONFLICT BETWEEN THE TERMS OF THIS SECTION AND THE WARRANTY BOOKLET, THE WARRANTY BOOKLET SHALL CONTROL.

Applicable Law, Venue, Jurisdiction

- The laws of the State of Michigan govern this EULA and Your use of the SOFTWARE. Your use of the SOFTWARE may also be subject to other local, state, national, or international laws. Any litigation arising out of or related to this EULA shall be brought and maintained exclusively in a court of the State of Michigan located in Wayne County or in the United States District Court for the Eastern District of Michigan. You hereby consent to submit to the personal jurisdiction of a court in the State of Michigan located in Wayne County and the United States District Court for the Eastern District of Michigan for any dispute arising out of or relating to this EULA.

Customer Information

Binding Arbitration and Class Action Waiver

(a) Application. This Section applies to any dispute EXCEPT IT DOES NOT INCLUDE A DISPUTE RELATING TO COPYRIGHT INFRINGEMENT, OR TO THE ENFORCEMENT OR VALIDITY OF YOUR, FORD MOTOR COMPANY, OR ANY OF FORD MOTOR COMPANY'S LICENSORS' INTELLECTUAL PROPERTY RIGHTS. Dispute means any dispute, action, or other controversy between You and FORD MOTOR COMPANY, other than the exceptions listed above, concerning the SOFTWARE (including its price) or this EULA, whether in contract, warranty, tort, statute, regulation, ordinance, or any other legal or equitable basis.

(b) Notice of Dispute. In the event of a Dispute, You or FORD MOTOR COMPANY must give the other a "Notice of Dispute", which is a written statement of the name, address, and contact information of the party giving it, the facts giving rise to the dispute, and the relief requested. You and FORD MOTOR COMPANY will attempt to resolve any dispute through informal negotiation within 60 days from the date the Notice of Dispute is sent. After 60 days, You or FORD MOTOR COMPANY may commence arbitration.

(c) Small claims court. You may also litigate any dispute in small claims court in your county of residence or FORD MOTOR COMPANY'S principal place of business, if the dispute meets all requirements to be heard in the small claims court. You may litigate in small claims court whether or not You negotiated informally first.

(d) Binding arbitration. If You and FORD MOTOR COMPANY, do not resolve any dispute by informal negotiation or in small claims court, any other effort to resolve the dispute will be conducted exclusively by binding arbitration. You are giving up

the right to litigate (or participate in as a party or class member) all disputes in court before a judge or jury. Instead, all disputes will be resolved before a neutral arbitrator, whose decision will be final except for a limited right of appeal under the Federal Arbitration Act. Any court with jurisdiction over the parties may enforce the arbitrator's award.

(e) Class action waiver. Any proceedings to resolve or litigate any dispute in any forum will be conducted solely on an individual basis. Neither you nor FORD MOTOR COMPANY, will seek to have any dispute heard as a class action, as a private attorney general action, or in any other proceeding in which any party acts or proposes to act in a representative capacity. No arbitration or proceeding will be combined with another without the prior written consent of all parties to all affected arbitrations or proceedings.

(f) Arbitration procedure. Any arbitration will be conducted by the American Arbitration Association (the "AAA"), under its Commercial Arbitration Rules. If You are an individual and use the SOFTWARE for personal or vehicle use, or if the value of the dispute is \$75,000 or less whether or not You are an individual or how You use the SOFTWARE, the AAA Supplementary Procedures for Consumer-Related Disputes will also apply. To commence arbitration, submit a Commercial Arbitration Rules Demand for Arbitration form to the AAA. You may request a telephonic or in-person hearing by following the AAA rules. In a dispute involving \$10,000 or less, any hearing will be telephonic unless the arbitrator finds good cause to hold an in-person hearing instead. For more information, see adr.org or call 1-800-778-7879. You agree to commence arbitration only in your county of residence or FORD MOTOR COMPANY'S principal place of business. The arbitrator

Customer Information

may award the same damages to you individually as a court could. The arbitrator may award declaratory or injunctive relief only to you individually, and only to the extent required to satisfy your individual claim.

(g) Arbitration fees and incentives.

- i. Disputes involving \$75,000 or less. FORD MOTOR COMPANY will promptly reimburse your filing fees and pay the AAA's and arbitrator's fees and expenses. If you reject FORD MOTOR COMPANY'S last written settlement offer made before the arbitrator was appointed ("last written offer"), your dispute goes all the way to an arbitrator's decision (called an "award"), and the arbitrator awards you more than the last written offer, FORD MOTOR COMPANY will give you three incentives: (1) pay the greater of the award or \$1,000; (2) pay twice your reasonable attorney's fees, if any; and (3) reimburse any expenses (including expert witness fees and costs) that your attorney reasonably accrues for investigating, preparing, and pursuing your claim in arbitration. The arbitrator will determine the amounts.
- ii. Disputes involving more than \$75,000. The AAA rules will govern payment of filing fees and the AAA's and arbitrator's fees and expenses.
- iii. Disputes involving any amount. In any arbitration you commence, FORD MOTOR COMPANY will seek its AAA or arbitrator's fees and expenses, or Your filing fees it reimbursed, only if the arbitrator finds the arbitration frivolous or brought for an improper purpose. In any arbitration FORD MOTOR COMPANY commences, it will pay all

filing, AAA, and arbitrator's fees and expenses. It will not seek its attorney's fees or expenses from you in any arbitration. Fees and expenses are not counted in determining how much a dispute involves.

(h) Claims or disputes must be filed within one year. To the extent permitted by law, any claim or dispute under this EULA to which this Section applies must be filed within one year in small claims court (Section c) or in arbitration (Section d). The one-year period begins when the claim or dispute first could be filed. If such a claim or dispute is not filed within one year, it is permanently barred.

(i) Severability. If the class action waiver (Section e) is found to be illegal or unenforceable as to all or some parts of a dispute, then that portion of Section e will not apply to those parts. Instead, those parts will be severed and proceed in a court of law, with the remaining parts proceeding in arbitration. If any other provision of that portion Section e is found to be illegal or unenforceable, that provision will be severed with the remainder of Section e remaining in full force and effect.

Telenav Software End User License Agreement

Please read these terms and conditions carefully before you use the TeleNav Software. Your use of the TeleNav Software indicates that you accept these terms and conditions. If you do not accept these terms and conditions, do not break the seal of the package, launch, or otherwise use the TeleNav Software. TeleNav may revise this Agreement and the privacy policy at any time, with or without notice to you. You agree to visit <http://www.telenav.com> from time to time to review the then current version of this Agreement and of the privacy policy.

Customer Information

1. Safe and Lawful Use

You acknowledge that devoting attention to the TeleNav Software may pose a risk of injury or death to you and others in situations that otherwise require your undivided attention, and you therefore agree to comply with the following when using the TeleNav Software:

- (a) observe all traffic laws and otherwise drive safely;
- (b) use your own personal judgment while driving. If you feel that a route suggested by the TeleNav Software instructs you to perform an unsafe or illegal maneuver, places you in an unsafe situation, or directs you into an area that you consider to be unsafe, do not follow such instructions;
- (c) do not input destinations, or otherwise manipulate the TeleNav Software, unless your vehicle is stationary and parked;
- (d) do not use the TeleNav Software for any illegal, unauthorized, unintended, unsafe, hazardous, or unlawful purposes, or in any manner inconsistent with this Agreement;
- (e) arrange all GPS and wireless devices and cables necessary for use of the TeleNav Software in a secure manner in your vehicle so that they will not interfere with your driving and will not prevent the operation of any safety device (such as an airbag).

You agree to indemnify and hold TeleNav harmless against all claims resulting from any dangerous or otherwise inappropriate use of the TeleNav Software in any moving vehicle, including as a result of your failure to comply with the directions above.

2. Account Information

You agree: (a) when registering the TeleNav Software, to provide TeleNav with true, accurate, current, and complete information about yourself, and (b) to inform TeleNav promptly of any changes to such information, and to keep it true, accurate, current and complete.

3. Software License

- Subject to your compliance with the terms of this Agreement, TeleNav hereby grants to you a personal, non-exclusive, non-transferable license (except as expressly permitted below in connection with your permanent transfer of the TeleNav Software license), without the right to sublicense, to use the TeleNav Software (in object code form only) in order to access and use the TeleNav Software. This license shall terminate upon any termination or expiration of this Agreement. You agree that you will use the TeleNav Software only for your personal business or leisure purposes, and not to provide commercial navigation services to other parties.

3.1 License Limitations

- **(a)** reverse engineer, decompile, disassemble, translate, modify, alter or otherwise change the TeleNav Software or any part thereof; **(b)** attempt to derive the source code, audio library or structure of the TeleNav Software without the prior express written consent of TeleNav; **(c)** remove from the TeleNav Software, or alter, any of TeleNav's or its suppliers' trademarks, trade names, logos, patent or copyright notices, or other notices or markings; **(d)**

Customer Information

distribute, sublicense or otherwise transfer the TeleNav Software to others, except as part of your permanent transfer of the TeleNav Software; or **(e)** use the TeleNav Software in any manner that

- i. infringes the intellectual property or proprietary rights, rights of publicity or privacy or other rights of any party,
- ii. violates any law, statute, ordinance or regulation, including but not limited to laws and regulations related to spamming, privacy, consumer and child protection, obscenity or defamation, or
- iii. is harmful, threatening, abusive, harassing, tortuous, defamatory, vulgar, obscene, libelous, or otherwise objectionable; and (f) lease, rent out, or otherwise permit unauthorized access by third parties to the TeleNav Software without advanced written permission of TeleNav.

4. Disclaimers

- To the fullest extent permissible pursuant to applicable law, in no event will TeleNav, its licensors and suppliers, or agents or employees of any of the foregoing, be liable for any decision made or action taken by you or anyone else in reliance on the information provided by the TeleNav Software. TeleNav also does not warrant the accuracy of the map or other data used for the TeleNav Software. Such data may not always reflect reality due to, among other things, road closures, construction, weather, new roads and other changing conditions. You are responsible for the entire risk arising out of your use of the TeleNav Software. For example but without limitation, you agree not to rely on the TeleNav Software for critical navigation in areas where the well-being or survival of you or others

is dependent on the accuracy of navigation, as the maps or functionality of the TeleNav Software are not intended to support such high risk applications, especially in more remote geographical areas.

- TELENAV EXPRESSLY DISCLAIMS AND EXCLUDES ALL WARRANTIES IN CONNECTION WITH THE TELENAV SOFTWARE, WHETHER STATUTORY, EXPRESS OR IMPLIED, INCLUDING ALL WARRANTIES WHICH MAY ARISE FROM COURSE OF DEALING, CUSTOM OR TRADE AND INCLUDING, BUT NOT LIMITED TO, THE IMPLIED WARRANTIES OF MERCHANTABILITY, FITNESS FOR A PARTICULAR PURPOSE AND NON-INFRINGEMENT OF THIRD PARTY RIGHTS WITH RESPECT TO THE TELENAV SOFTWARE.
- Certain jurisdictions do not permit the disclaimer of certain warranties, so this limitation may not apply to you.

5. Limitation of Liability

- TO THE EXTENT PERMITTED UNDER APPLICABLE LAW, UNDER NO CIRCUMSTANCES SHALL TELENAV OR ITS LICENSORS AND SUPPLIERS BE LIABLE TO YOU OR TO ANY THIRD PARTY FOR ANY INDIRECT, INCIDENTAL, CONSEQUENTIAL, SPECIAL OR EXEMPLARY DAMAGES (INCLUDING IN EACH CASE, BUT NOT LIMITED TO, DAMAGES FOR THE INABILITY TO USE THE EQUIPMENT OR ACCESS DATA, LOSS OF DATA, LOSS OF BUSINESS, LOSS OF PROFITS, BUSINESS INTERRUPTION OR THE LIKE) ARISING OUT OF THE USE OF OR INABILITY TO USE THE TELENAV SOFTWARE, EVEN IF TELENAV HAS BEEN ADVISED OF THE POSSIBILITY OF SUCH DAMAGES. NOTWITHSTANDING ANY DAMAGES THAT YOU MIGHT INCUR FOR ANY

Customer Information

REASON WHATSOEVER (INCLUDING, WITHOUT LIMITATION, ALL DAMAGES REFERENCED HEREIN AND ALL DIRECT OR GENERAL DAMAGES IN CONTRACT, TORT (INCLUDING NEGLIGENCE) OR OTHERWISE), THE ENTIRE LIABILITY OF TELENAV AND OF ALL OF TELENAV'S SUPPLIERS SHALL BE LIMITED TO THE AMOUNT ACTUALLY PAID BY YOU FOR THE TELENAV SOFTWARE. SOME STATES AND/OR JURISDICTIONS DO NOT ALLOW THE EXCLUSION OR LIMITATION OF INCIDENTAL OR CONSEQUENTIAL DAMAGES, SO THE ABOVE LIMITATIONS OR EXCLUSIONS MAY NOT APPLY TO YOU.

6. Arbitration and Governing Law

- You agree that any dispute, claim or controversy arising out of or relating to this Agreement or the TeleNav Software shall be settled by independent arbitration involving a neutral arbitrator and administered by the American Arbitration Association in the County of Santa Clara, California. The arbitrator shall apply the Commercial Arbitration Rules of the American Arbitration Association, and the judgment upon the award rendered by the arbitrator may be entered by any court having jurisdiction. Note that there is no judge or jury in an arbitration proceeding and the decision of the arbitrator shall be binding upon both parties. You expressly agree to waive your right to a jury trial. This Agreement and performance hereunder will be governed by and construed in accordance with the laws of the State of California, without giving effect to its conflict of law provisions. To the extent judicial action is necessary in connection with the binding arbitration, both TeleNav and you agree to submit

to the exclusive jurisdiction of the courts of the County of Santa Clara, California. The United Nations Convention on Contracts for the International Sale of Goods shall not apply.

7. Assignment

- You may not resell, assign, or transfer this Agreement or any of your rights or obligations, except in totality, in connection with your permanent transfer of the TeleNav Software, and expressly conditioned upon the new user of the TeleNav Software agreeing to be bound by the terms and conditions of this Agreement. Any such sale, assignment or transfer that is not expressly permitted under this paragraph will result in immediate termination of this Agreement, without liability to TeleNav, in which case you and all other parties shall immediately cease all use of the TeleNav Software. Notwithstanding the foregoing, TeleNav may assign this Agreement to any other party at any time without notice, provided the assignee remains bound by this Agreement.

8. Miscellaneous

8.1

This Agreement constitutes the entire agreement between TeleNav and you with respect to the subject matter hereof.

8.2

Except for the limited licenses expressly granted in this Agreement, TeleNav retains all right, title and interest in and to the TeleNav Software, including without limitation all related intellectual property rights. No licenses or other rights which are not expressly granted in this Agreement are intended to, or shall be, granted or

Customer Information

conferred by implication, statute, inducement, estoppel or otherwise, and TeleNav and its suppliers and licensors hereby reserve all of their respective rights other than the licenses explicitly granted in this Agreement.

8.3

By using the TeleNav Software, you consent to receive from TeleNav all communications, including notices, agreements, legally required disclosures or other information in connection with the TeleNav Software (collectively, "Notices") electronically. TeleNav may provide such Notices by posting them on TeleNav's Website or by downloading such Notices to your wireless device. If you desire to withdraw your consent to receive Notices electronically, you must discontinue your use of the TeleNav Software.

8.4

TeleNav's or your failure to require performance of any provision shall not affect that party's right to require performance at any time thereafter, nor shall a waiver of any breach or default of this Agreement constitute a waiver of any subsequent breach or default or a waiver of the provision itself.

8.5

If any provision herein is held unenforceable, then such provision will be modified to reflect the intention of the parties, and the remaining provisions of this Agreement will remain in full force and effect.

8.6

The headings in this Agreement are for convenience of reference only, will not be deemed to be a part of this Agreement, and will not be referred to in connection with the construction or interpretation of this Agreement. As used in this Agreement, the words "include" and "including" and variations thereof, will not be deemed to be terms of limitation, but rather will be deemed to be followed by the words "without limitation".

9. Other Vendors Terms and Conditions

- The Telenav Software utilizes map and other data licensed to Telenav by third party vendors for the benefit of you and other end users. This Agreement includes end-user terms applicable to these companies (included at the end of this Agreement), and thus your use of the Telenav Software is also subject to such terms. You agree to comply with the following additional terms and conditions, which are applicable to Telenav's third party vendor licensors.

9.1 End User Terms Required by HERE North America, LLC

The data ("Data") is provided for your personal, internal use only and not for resale. It is protected by copyright, and is subject to the following terms and conditions which are agreed to by you, on the one hand, and Telenav ("Telenav") and its licensors (including their licensors and suppliers) on the other hand.

© 2013 HERE. All rights reserved.

The Data for areas of Canada includes information taken with permission from Canadian authorities, including: © Her Majesty the Queen in Right of Canada, © Queen's Printer for Ontario, © Canada Post Corporation, GeoBase®, © Department of Natural Resources Canada.

Customer Information

HERE holds a non-exclusive license from the United States Postal Service® to publish and sell ZIP+4® information.

©United States Postal Service® 2014. Prices are not established, controlled or approved by the United States Postal Service®. The following trademarks and registrations are owned by the USPS: United States Postal Service, USPS, and ZIP+4

The Data for Mexico includes certain data from Instituto Nacional de Estadística y Geografía.

9.2 End User Terms Required by NAV2 (Shanghai) Co., Ltd

The data (“Data”) is provided for your personal, internal use only and not for resale. It is protected by copyright, and is subject to the following terms and conditions which are agreed to by you, on the one hand, and NAV2 (Shanghai) Co., Ltd (“NAV2”) and its licensors (including their licensors and suppliers) on the other hand. 20xx. All rights reserved

Terms and Conditions

Permitted Use. You agree to use this Data together with the Telenav Software solely for the internal business and personal purposes for which you were licensed, and not for service bureau, time-sharing or other similar purposes. Accordingly, but subject to the restrictions set forth in the following paragraphs, you agree not to otherwise reproduce, copy, modify, decompile, disassemble, create any derivative works of, or reverse engineer any portion of this Data, and may not transfer or distribute it in any form, for any purpose, except to the extent permitted by mandatory laws.

Restrictions. Except where you have been specifically licensed to do so by Telenav, and without limiting the preceding paragraph, you may not use this Data (a) with any products, systems, or applications installed or otherwise connected to or in communication with vehicles, capable of vehicle navigation, positioning, dispatch, real time route guidance, fleet management or similar applications; or (b) with or in communication with any positioning devices or any mobile or wireless-connected electronic or computer devices, including without limitation cellular phones, palmtop and handheld computers, pagers, and personal digital assistants or PDAs.

Warning. The Data may contain inaccurate or incomplete information due to the passage of time, changing circumstances, sources used and the nature of collecting comprehensive geographic data, any of which may lead to incorrect results.

No Warranty. This Data is provided to you “as is,” and you agree to use it at your own risk. Telenav and its licensors (and their licensors and suppliers) make no guarantees, representations or warranties of any kind, express or implied, arising by law or otherwise, including but not limited to, content, quality, accuracy, completeness, effectiveness, reliability, fitness for a particular purpose, usefulness, use or results to be obtained from this Data, or that the Data or server will be uninterrupted or error-free.

Disclaimer of Warranty: TELENAV AND ITS LICENSORS (INCLUDING THEIR LICENSORS AND SUPPLIERS) DISCLAIM ANY WARRANTIES, EXPRESS OR IMPLIED, OF QUALITY, PERFORMANCE, MERCHANTABILITY, FITNESS FOR A

Customer Information

PARTICULAR PURPOSE OR NON-INFRINGEMENT. Some States, Territories and Countries do not allow certain warranty exclusions, so to that extent the above exclusion may not apply to you.

Disclaimer of Liability: TELENAV AND ITS LICENSORS (INCLUDING THEIR LICENSORS AND SUPPLIERS) SHALL NOT BE LIABLE TO YOU: IN RESPECT OF ANY CLAIM, DEMAND OR ACTION, IRRESPECTIVE OF THE NATURE OF THE CAUSE OF THE CLAIM, DEMAND OR ACTION ALLEGING ANY LOSS, INJURY OR DAMAGES, DIRECT OR INDIRECT, WHICH MAY RESULT FROM THE USE OR POSSESSION OF THE INFORMATION; OR FOR ANY LOSS OF PROFIT, REVENUE, CONTRACTS OR SAVINGS, OR ANY OTHER DIRECT, INDIRECT, INCIDENTAL, SPECIAL OR CONSEQUENTIAL DAMAGES ARISING OUT OF YOUR USE OF OR INABILITY TO USE THIS INFORMATION, ANY DEFECT IN THE INFORMATION, OR THE BREACH OF THESE TERMS OR CONDITIONS, WHETHER IN AN ACTION IN CONTRACT OR TORT OR BASED ON A WARRANTY, EVEN IF TELENAV OR ITS LICENSORS HAVE BEEN ADVISED OF THE POSSIBILITY OF SUCH DAMAGES. Some States, Territories and Countries do not allow certain liability exclusions or damages limitations, so to that extent the above may not apply to you.

Export Control. You shall not export from anywhere any part of the Data or any direct product thereof except in compliance with, and with all licenses and approvals required under, applicable export laws, rules and regulations, including but not limited to the laws, rules and regulations administered by the Office of Foreign Assets Control of the U.S. Department of Commerce and the Bureau of Industry and Security of the U.S. Department of Commerce. To the extent that any such

export laws, rules or regulations prohibit HERE from complying with any of its obligations hereunder to deliver or distribute Data, such failure shall be excused and shall not constitute a breach of this Agreement.

Entire Agreement. These terms and conditions constitute the entire agreement between Telenav (and its licensors, including their licensors and suppliers) and you pertaining to the subject matter hereof, and supersedes in their entirety any and all written or oral agreements previously existing between us with respect to such subject matter.

Governing Law. The above terms and conditions shall be governed by the laws of the State of Illinois [insert "Netherlands" where European HERE Data is used], without giving effect to (i) its conflict of laws provisions, or (ii) the United Nations Convention for Contracts for the International Sale of Goods, which is explicitly excluded. You agree to submit to the jurisdiction of the State of Illinois [insert "The Netherlands" where European HERE Data is used] for any and all disputes, claims and actions arising from or in connection with the Data provided to you hereunder.

Government End Users. If the Data is being acquired by or on behalf of the United States government or any other entity seeking or applying rights similar to those customarily claimed by the United States government, this Data is a "commercial item" as that term is defined at 48 C.F.R. ("FAR") 2.101, is licensed in accordance with these End-User Terms, and each copy of Data delivered or otherwise furnished shall be marked and embedded as appropriate with the following "Notice of Use," and shall be treated in accordance with such Notice:

Customer Information

NOTICE OF USE

CONTRACTOR (MANUFACTURER/
SUPPLIER) NAME: HERE

CONTRACTOR (MANUFACTURER/
SUPPLIER) ADDRESS: c/o Nokia, 425
West Randolph Street, Chicago, Illinois
60606

This Data is a commercial item as
defined in FAR 2.101 and is subject to
these End-User Terms under which this
Data was provided.

© 1987 – 2014 HERE – All rights reserved.

If the Contracting Officer, federal government agency, or any federal official refuses to use the legend provided herein, the Contracting Officer, federal government agency, or any federal official must notify HERE prior to seeking additional or alternative rights in the Data.

I. US/Canada Territory

A. United States Data. The End-User Terms for any Application containing Data for the United States shall contain the following notices:

“HERE holds a non-exclusive license from the United States Postal Service® to publish and sell ZIP+4® information.”

“©United States Postal Service® 20XX. Prices are not established, controlled or approved by the United States Postal Service®. The following trademarks and registrations are owned by the USPS: United States Postal Service, USPS, and ZIP+4.”

B. Canada Data. The following provisions apply to the Data for Canada, which may include or reflect data from third party licensors (“Third Party Data”), including Her Majesty the Queen in Right of Canada (“Her Majesty”), Canada Post Corporation (“Canada Post”) and the Department of Natural Resources of Canada (“NRCan”):

1. Disclaimer and Limitation: Client agrees that its use of the Third Party Data is subject to the following provisions:

a. Disclaimer: The Third Party Data is licensed on an “as is” basis. The licensors of such data, including Her Majesty, Canada Post and NRCan, make no guarantees, representations or warranties respecting such data, either express or implied, arising by law or otherwise, including but not limited to, effectiveness, completeness, accuracy or fitness for a particular purpose.

b. Limitation on Liability: The Third Party Data licensors, including Her Majesty, Canada Post and NRCan, shall not be liable: (i) in respect of any claim, demand or action, irrespective of the nature of the cause of the claim, demand or action alleging any loss, injury or damages, direct or indirect, which may result from the use or possession of such Data; or (ii) in any way for loss of revenues or contracts, or any other consequential loss of any kind resulting from any defect in the Data.

Customer Information

2. Copyright Notice: In connection with each copy of all or any portion of the Data for the Territory of Canada, Client shall affix in a conspicuous manner the following copyright notice on at least one of: (i) the label for the storage media of the copy; (ii) the packaging for the copy; or (iii) other materials packaged with the copy, such as user manuals or end user license agreements: "This data includes information taken with permission from Canadian authorities, including © Her Majesty the Queen in Right of Canada, © Queen's Printer for Ontario, © Canada Post Corporation, GeoBase®, © The Department of Natural Resources Canada. All rights reserved."

3. End-User Terms: Except as otherwise agreed by the parties, in connection with the provision of any portion of the Data for the Territory of Canada to End-Users as may be authorized under the Agreement, Client shall provide such End-Users, in a reasonably conspicuous manner, with terms (set forth with other end user terms required to be provided under the Agreement, or as otherwise may be provided, by Client) which shall include the following provisions on behalf of the Third Party Data licensors, including Her Majesty, Canada Post and NRCan:

The Data may include or reflect data of licensors, including Her Majesty the Queen in the Right of Canada ("Her Majesty"), Canada Post Corporation ("Canada Post") and the Department of Natural Resources Canada ("NRCan"). Such data is licensed on an "as is" basis. The licensors, including Her Majesty, Canada Post and NRCan, make no guarantees, representations or warranties respecting such data,

either express or implied, arising by law or otherwise, including but not limited to, effectiveness, completeness, accuracy or fitness for a particular purpose. The licensors, including Her Majesty, Canada Post and NRCan, shall not be liable in respect of any claim, demand or action, irrespective of the nature of the cause of the claim, demand or action alleging any loss, injury or damages, direct or indirect, which may result from the use or possession of the data or the Data. The licensors, including Her Majesty, Canada Post and NRCan, shall not be liable in any way for loss of revenues or contracts, or any other consequential loss of any kind resulting from any defect in the data or the Data.

End User shall indemnify and save harmless the licensors, including Her Majesty, Canada Post and NRCan, and their officers, employees and agents from and against any claim, demand or action, irrespective of the nature of the cause of the claim, demand or action, alleging loss, costs, expenses, damages or injuries (including injuries resulting in death) arising out of the use or possession of the data or the Data.

4. Additional Provisions: The terms contained in this Section are in addition to all of the rights and obligations of the parties under the Agreement. To the extent that any of the provisions of this Section are inconsistent with, or conflict with, any other provisions of the Agreement, the provisions of this Section shall prevail.

Customer Information

II. Mexico. The following provision applies to the Data for Mexico, which includes certain data from the Instituto Nacional de Estadística y Geografía (“INEGI”):

A. Any and all copies of the Data and/or packaging containing Data for Mexico shall contain the following notice: “Fuente: INEGI (Instituto Nacional de Estadística y Geografía)”

III. Latin America Territory

A. Third Party Notices. Any and all copies of the Data and/or packaging relating thereto shall include the respective Third Party Notices set forth below and used as described below corresponding to the Territory (or portion thereof) included in such copy:

Territory Notice

| | |
|---|--|
| Argentina | IGN “INSTITUTO GEOGRAFICO NACIONAL ARGENTINO” |
| Ecuador | “INSTITUTO GEOGRAFICO MILITAR DEL ECUADOR AUTORIZACION N° IGM-2011-01- PCO-01 DEL 25 DE ENERO DE 2011” “source: © IGN 2009 - BD TOPO ®” |
| Guadeloupe, French Guiana and Martinique Mexico | “Fuente: INEGI (Instituto Nacional de Estadística y Geografía)” |

IV. Middle East Territory

A. Third Party Notices. Any and all copies of the Data and/or packaging relating thereto shall include the respective Third Party Notices set forth below and used as described below corresponding to the Territory (or portion thereof) included in such copy:

Country Notice

Jordan “© Royal Jordanian Geographic Centre”. The foregoing notice requirement for Jordan Data is a material term of the Agreement. If Client or any of its permitted sublicensees (if any) fail to meet such requirement, HERE shall have the right to terminate Client’s license with respect to the Jordan Data.

B. Jordan Data. Client and its permitted sublicensees (if any) are restricted from licensing and/or otherwise distributing HERE’s database for the country of Jordan (“Jordan Data”) for use in Enterprise Applications to (i) non-Jordanian entities for use of the Jordan Data solely in Jordan or (ii) Jordan-based customers. In addition, Client, its permitted sublicensees (if any) and End-Users are restricted from using the Jordan Data in Enterprise Applications if such party is (i) a non-Jordanian entity using the Jordan Data solely in Jordan or (ii) a Jordan-based customer. For purposes of the foregoing, “Enterprise Applications” shall mean Geomarketing applications, GIS applications, mobile business asset management applications, call center applications, telematics applications, public organization Internet applications or for providing geocoding services.

Customer Information

V. Europe Territory

A. Use of Certain Traffic Codes in Europe

1. General Restrictions Applicable to Traffic Codes. Client acknowledges and agrees that in certain countries of the Europe Territory, Client will need to obtain rights directly from third party RDS-TMC code providers to receive and use the Traffic Codes in the Data and to deliver to End-Users Transactions in any way derived from or based on such Traffic Codes. For such countries, HERE shall deliver the Data incorporating Traffic Codes to Client only after receiving certification from Client of its having obtained such rights.

2. Display of Third Party Rights Legends for Belgium. Client shall, for each Transaction that uses Traffic Codes for Belgium, provide the following notice to the End-User: "Traffic Codes for Belgium are provided by the Ministerie van de Vlaamse Gemeenschap and the Ministère de l'Équipement et des Transports."

B. Paper Maps. With respect to any license granted to Client relating to making, selling or distributing paper maps (i.e., a map fixed on a paper or paper-like medium): (a) such license with respect to Data for the Territory of Great Britain is conditioned on Client's entering into and complying with a separate written agreement with the Ordnance Survey ("OS") to create and sell paper maps, Client's paying to the OS any and all applicable paper map royalties, and Client's complying with the OS copyright notice requirements; (b) such license for selling or otherwise distributing for charge with respect to Data for the Territory of Czech Republic

is conditioned on Client's obtaining prior written consent from Kartografie a.s.; (c) such license for selling or distributing with respect to Data for the Territory of Switzerland is conditioned on Client's obtaining a permit from Bundesamt für Landestopografie of Switzerland; (d) Client is restricted from using Data for the Territory of France to create paper maps with a scale between 1:5,000 and 1:250,000; and (e) Client is restricted from using any Data to create, sell or distribute paper maps that are the same or substantially similar, in terms of data content and specific use of color, symbols and scale, to paper maps published by the European national mapping agencies, including without limitation, Landvermessungämter of Germany, Topografische Dienst of the Netherlands, Nationaal Geografisch Instituut of Belgium, Bundesamt für Landestopografie of Switzerland, Bundesamt für Eich-und Vermessungswesen of Austria, and the National Land Survey of Sweden.

C. OS Enforcement. Without limiting Section IV(B) above, with respect to Data for the Territory of Great Britain, Client acknowledges and agrees that the Ordnance Survey ("OS") may bring a direct action against Client to enforce compliance with the OS copyright notice (see Section IV(D) below) and paper map requirements (see Section IV(B) above) contained in this Agreement.

D. Third Party Notices. Any and all copies of the Data and/or packaging relating thereto shall include the respective Third Party Notices set forth below and used as described below corresponding to the Territory (or portion thereof) included in such copy:

Country(ies) Notice

Customer Information

| | | | |
|---|--|---|---|
| Austria | “© Bundesamt für Eich- und Vermessungswesen” | Spain | “Información geográfica propiedad del CNIG” |
| Croatia Cyprus, Estonia, Latvia, Lithuania, Moldova, Poland, Slovenia and/or Ukraine | “© EuroGeographics” | Sweden | “Based upon electronic data © National Land Survey Sweden.” |
| France | “source: © IGN 2009 – BD TOPO ®” | Switzerland | “Topografische Grundlage: © Bundesamt für Landestopographie. |
| Germany | “Die Grundlagendaten wurden mit Genehmigung der zuständigen Behörden entnommen” | E. Respective Country Distribution. Client acknowledges that HERE has not received approvals to distribute map data for the following countries in such respective countries: Albania, Belarus, Kyrgyzstan, Moldova and Uzbekistan. HERE may update such list from time to time. The license rights granted to Client under this TL with respect to the Data for such countries are contingent upon Client’s compliance with all applicable laws and regulations, including, without limitation, any required licenses or approvals to distribute the Application incorporating such Data in such respective countries. | |
| Great Britain | “Contains Ordnance Survey data © Crown copyright and database right 2010 Contains Royal Mail data © Royal Mail copyright and database right 2010” | VI. Australia Territory | A. Third Party Notices. Any and all copies of the Data and/or packaging relating thereto shall include the respective Third Party Notices set forth below and used as described below corresponding to the Territory (or portion thereof) included in such copy: Copyright. Based on data provided under license from PSMA Australia Limited (www.pasma.com.au). |
| Greece | “Copyright Geomatics Ltd.” | | |
| Hungary | “Copyright © 2003; Top-Map Ltd.” | | |
| Italy | “La Banca Dati Italiana è stata prodotta usando quale riferimento anche cartografia numerica ed al tratto prodotta e fornita dalla Regione Toscana.” | | |
| Norway | “Copyright © 2000; Norwegian Mapping Authority” | | |
| Portugal | “Source: IgeoE – Portugal” | | |

Customer Information

Product incorporates data which is © 20XX Telstra Corporation Limited, GM Holden Limited, Intelomatics Australia Pty Ltd and Continental Pty Ltd.

B. Third Party Notices for Australia. In addition to the foregoing, the End-User Terms for any Application containing RDS-TMC Traffic Codes for Australia shall contain the following notice: “Product incorporates traffic location codes which is © 20XX Telstra Corporation Limited and its licensors.”

AT&T Vehicle Network Carrier Telematics Disclosure

END USER FOR PURPOSES OF THIS SECTION MEANS YOU AND YOUR HEIRS, EXECUTORS, LEGAL PERSONAL REPRESENTATIVES AND PERMITTED ASSIGNS. FOR PURPOSES OF THIS SECTION “UNDERLYING WIRELESS SERVICE CARRIER” INCLUDES ITS AFFILIATES AND CONTRACTORS AND THEIR RESPECTIVE OFFICERS, DIRECTORS, EMPLOYEES, SUCCESSORS AND ASSIGNS. END USER HAS NO CONTRACTUAL RELATIONSHIP WITH THE UNDERLYING WIRELESS SERVICE CARRIER AND END USER IS NOT A THIRD PARTY BENEFICIARY OF ANY AGREEMENT BETWEEN FORD AND UNDERLYING CARRIER. END USER UNDERSTANDS AND AGREES THAT THE UNDERLYING CARRIER HAS NO LEGAL, EQUITABLE, OR OTHER LIABILITY OF ANY KIND TO END USER. IN ANY EVENT, REGARDLESS OF THE FORM OF THE ACTION, WHETHER FOR BREACH OF CONTRACT, WARRANTY, NEGLIGENCE, STRICT LIABILITY IN TORT OR OTHERWISE, END USER’S EXCLUSIVE REMEDY FOR CLAIMS ARISING IN ANY WAY IN CONNECTION WITH THIS AGREEMENT, FOR ANY CAUSE WHATSOEVER, INCLUDING BUT NOT LIMITED TO ANY FAILURE OR

DISRUPTION OF SERVICE PROVIDED HEREUNDER, IS LIMITED TO PAYMENT OF DAMAGES IN AN AMOUNT NOT TO EXCEED THE AMOUNT PAID BY END USER FOR THE SERVICES DURING THE TWO-MONTH PERIOD PRECEDING THE DATE THE CLAIM AROSE.

(ii) END USER AGREES TO INDEMNIFY AND HOLD HARMLESS THE UNDERLYING WIRELESS SERVICE CARRIER AND ITS OFFICERS, EMPLOYEES, AND AGENTS AGAINST ANY AND ALL CLAIMS, INCLUDING WITHOUT LIMITATION CLAIMS FOR LIBEL, SLANDER, OR ANY PROPERTY DAMAGE, PERSONAL INJURY OR DEATH, ARISING IN ANY WAY, DIRECTLY OR INDIRECTLY, IN CONNECTION WITH THIS AGREEMENT OR THE USE, FAILURE TO USE, OR INABILITY TO USE THE DEVICE EXCEPT WHERE THE CLAIMS RESULT FROM THE UNDERLYING CARRIER’S GROSS NEGLIGENCE OR WILLFUL MISCONDUCT. THIS INDEMNITY WILL SURVIVE THE TERMINATION OF THE AGREEMENT.

(iii) END USER HAS NO PROPERTY RIGHT IN ANY NUMBER ASSIGNED TO THE DEVICE.

(iv) END USER UNDERSTANDS THAT FORD AND THE UNDERLYING CARRIER CANNOT GUARANTY THE SECURITY OF WIRELESS TRANSMISSIONS, AND WILL NOT BE LIABLE FOR ANY LACK OF SECURITY RELATING TO THE USE OF THE SERVICES

THE SERVICE IS FOR [END USER’S] USE ONLY AND END USER MAY NOT RESELL THE SERVICE TO ANY OTHER PARTY END USER UNDERSTANDS THAT THE UNDERLYING CARRIER DOES NOT GUARANTEE ANY END USER UNINTERRUPTED SERVICE OR COVERAGE. THE UNDERLYING CARRIER DOES NOT WARRANT THAT END USERS CAN OR WILL BE LOCATED USING THE SERVICE. THE UNDERLYING CARRIER

Customer Information

MAKES NO WARRANTY, EXPRESS OR IMPLIED, OF MERCHANTABILITY OR FITNESS FOR A PARTICULAR PURPOSE, SUITABILITY, OR PERFORMANCE REGARDING ANY SERVICES OR GOODS, AND IN NO EVENT SHALL AT&T BE LIABLE, WHETHER OR NOT DUE TO ITS OWN NEGLIGENCE, FOR ANY: (A) ACT OR OMISSION OF A THIRD PARTY; (B) MISTAKES, OMISSIONS, INTERRUPTIONS, ERRORS, FAILURES TO TRANSMIT, DELAYS, OR DEFECTS IN THE SERVICE PROVIDED BY OR THROUGH THE UNDERLYING CARRIER; (C) DAMAGE OR INJURY CAUSED BY SUSPENSION OR TERMINATION BY THE UNDERLYING CARRIER; OR (D) DAMAGE OR INJURY CAUSED BY A FAILURE OR DELAY IN CONNECTING A CALL TO ANY ENTITY, INCLUDING 911 OR ANY OTHER EMERGENCY SERVICE. TO THE FULL EXTENT ALLOWED BY LAW, THE END USER RELEASES, INDEMNIFIES AND HOLDS THE UNDERLYING CARRIER HARMLESS FROM AND AGAINST ANY AND ALL CLAIMS OF ANY PERSON OR ENTITY FOR DAMAGES OF ANY NATURE ARISING IN ANY WAY FROM OR RELATING TO, DIRECTLY OR INDIRECTLY, SERVICES PROVIDED BY THE UNDERLYING CARRIER OR ANY PERSON'S USE THEREOF, INCLUDING CLAIMS ARISING IN WHOLE OR IN PART FROM THE ALLEGED NEGLIGENCE OF THE UNDERLYING CARRIER.

VII. China Territory

Personal Use Only

You agree to use this Data together with [insert name of Client Application] for the solely personal, non-commercial purposes for which you were licensed, and not for service bureau, time-sharing or other similar purposes. Accordingly, but subject to the restrictions set forth in the following paragraphs, you may copy this Data only as necessary for your personal use to (i)

view it, and (ii) save it, provided that you do not remove any copyright notices that appear and do not modify the Data in any way. You agree not to otherwise reproduce, copy, modify, decompile, disassemble or reverse engineer any portion of this Data, and may not transfer or distribute it in any form, for any purpose, except to the extent permitted by mandatory laws.

Restrictions

Except where you have been specifically licensed to do so by NAV2, and without limiting the preceding paragraph, you may not (a) use this Data with any products, systems, or applications installed or otherwise connected to or in communication with vehicles, capable of vehicle navigation, positioning, dispatch, real time route guidance, fleet management or similar applications; or (b) with or in communication with any positioning devices or any mobile or wireless-connected electronic or computer devices, including without limitation cellular phones, palmtop and handheld computers, pagers, and personal digital assistants or PDAs. You agree to cease using this Data if you fail to comply with these terms and conditions.

Limited Warranty

NAV2 warrants that (a) the Data will perform substantially in accordance with the accompanying written materials for a period of ninety (90) days from the date of receipt, and (b) any support services provided by NAV2 shall be substantially as described in applicable written materials provided to you by NAV2, and NAV2's support engineers will make commercially reasonable efforts to solve any problem issues.

Customer Information

Customer Remedies

NAV2 and its suppliers' entire liability and your exclusive remedy shall be, at NAV2's sole discretion, either (a) return of the price paid, if any, or (b) repair or replacement of the Data that do not meet NAV2's Limited Warranty and that are returned to NAV2 with a copy of your receipt. This Limited Warranty is void if failure of the Data has resulted from accident, abuse, or misapplication. Any replacement Data will be warranted for the remainder of the original warranty period or thirty (30) days, whichever is longer. Neither these remedies nor any product support services offered by NAV2 are available without proof of purchase from an authorized international source.

No Other Warranty:

EXCEPT FOR THE LIMITED WARRANTY SET FORTH ABOVE AND TO THE EXTENT PERMITTED BY APPLICABLE LAW, NAV2 AND ITS LICENSORS (INCLUDING THEIR LICENSORS AND SUPPLIERS) DISCLAIM ANY WARRANTIES, EXPRESS OR IMPLIED, OF QUALITY, PERFORMANCE, MERCHANTABILITY, FITNESS FOR A PARTICULAR PURPOSE, OWNERSHIP OR NON-INFRINGEMENT. Certain warranty exclusions may not be permitted under applicable law, so to that extent the above exclusion may not apply to you.

Limited Liability:

TO THE EXTENT PERMITTED BY APPLICABLE LAW, NAV2 AND ITS LICENSORS (INCLUDING THEIR LICENSORS AND SUPPLIERS) SHALL NOT BE LIABLE TO YOU: IN RESPECT OF ANY CLAIM, DEMAND OR ACTION, IRRESPECTIVE OF THE NATURE OF THE CAUSE OF THE CLAIM, DEMAND OR ACTION ALLEGING ANY LOSS, INJURY OR DAMAGES, DIRECT OR INDIRECT, WHICH MAY RESULT FROM THE USE OR POSSESSION OF THE INFORMATION; OR

FOR ANY LOSS OF PROFIT, REVENUE, CONTRACTS OR SAVINGS, OR ANY OTHER DIRECT, INDIRECT, INCIDENTAL, SPECIAL OR CONSEQUENTIAL DAMAGES ARISING OUT OF YOUR USE OF OR INABILITY TO USE THIS INFORMATION, ANY DEFECT IN THE INFORMATION, OR THE BREACH OF THESE TERMS OR CONDITIONS, WHETHER IN AN ACTION IN CONTRACT OR TORT OR BASED ON A WARRANTY, EVEN IF NAV2 OR ITS LICENSORS HAVE BEEN ADVISED OF THE POSSIBILITY OF SUCH DAMAGES. UNDER NO CIRCUMSTANCES SHALL NAV2'S OR ITS SUPPLIERS' LIABILITY HEREUNDER EXCEED THE PRICE PAID. Certain liability exclusions may not be permitted under applicable law, so to that extent the above exclusion may not apply to you.

Export Control

You agree not to export to anywhere any part of the Data provided to you or any direct product thereof except in compliance with, and with all licenses and approvals required under, applicable export laws, rules and regulations.

IP Protection

The Data are owned by NAV2 or its suppliers and are protected by applicable copyright and other intellectual property law and treaties. The Data are provided solely on the basis of a license to use, not sale.

Entire Agreement

These terms and conditions constitute the entire agreement between NAV2 (and its licensors, including their licensors and suppliers) and you pertaining to the subject matter hereof, and supersedes in their entirety any and all written or oral agreements previously existing between us with respect to such subject matter.

Customer Information

Governing Law.

The above terms and conditions shall be governed by the laws of the People's Republic of China, without giving effect to (i) its conflict of laws provisions, or (ii) the United Nations Convention for Contracts for the International Sale of Goods, which is explicitly excluded. Any dispute arising from or in connection with the Data provided to you hereunder shall be submitted to the Shanghai International Economic and Trade Arbitration Commission for arbitration.

Gracenote® Copyright

CD and music-related data from Gracenote, Inc., copyright©

2000-2007 Gracenote. Gracenote Software, copyright © 2000-2007 Gracenote. This product and service may practice one or more of the following U.S. Patents 5,987,525; 6,061,680; 6,154,773; 6,161,132; 6,230,192; 6,230,207; 6,240,459; 6,330,593 and other patents issued or pending. Some services supplied under license from Open Globe, Inc. for U.S. Patent 6,304,523.

Gracenote and CDDDB are registered trademarks of Gracenote. The Gracenote logo and logotype, and the "Powered by Gracenote™" logo are trademarks of Gracenote.

Gracenote® End User License Agreement (EULA)

This device contains software from Gracenote, Inc. of 2000 Powell Street Emeryville, California 94608 ("Gracenote").

The software from Gracenote (the "Gracenote Software") enables this device to do disc and music file identification and obtain music-related information, including name, artist, track, and title information ("Gracenote Data") from online servers

("Gracenote Servers"), and to perform other functions. You may use Gracenote Data only by means of the intended End User functions of this device. This device may contain content belonging to Gracenote's providers. If so, all of the restrictions set forth herein with respect to Gracenote Data shall also apply to such content and such content providers shall be entitled to all of the benefits and protections set forth herein that are available to Gracenote. You agree that you will use the content from Gracenote ("Gracenote Content"), Gracenote Data, the Gracenote Software, and Gracenote Servers for your own personal, non-commercial use only. You agree not to assign, copy, transfer or transmit the Gracenote Content, Gracenote Software or any Gracenote Data (except in a Tag associated with a music file) to any third party. YOU AGREE NOT TO USE OR EXPLOIT GRACENOTE CONTENT, GRACENOTE DATA, THE GRACENOTE SOFTWARE, OR GRACENOTE SERVERS, EXCEPT AS EXPRESSLY PERMITTED HEREIN.

You agree that your non-exclusive licenses to use the Gracenote Content, Gracenote Data, the Gracenote Software, and Gracenote Servers will terminate if you violate these restrictions. If your licenses terminate, you agree to cease any and all use of the Gracenote Content, Gracenote Data, the Gracenote Software, and Gracenote Servers.

Gracenote, respectively, reserve all rights in Gracenote Data, the Gracenote Software, and the Gracenote Servers and Gracenote Content, including all ownership rights. Under no circumstances will either Gracenote become liable for any payment to you for any information that you provide,

Customer Information

including any copyrighted material or music file information. You agree that Gracenote may enforce its respective rights, collectively or separately, under this agreement against you, directly in each company's own name.

Gracenote uses a unique identifier to track queries for statistical purposes. The purpose of a randomly assigned numeric identifier is to allow Gracenote to count queries without knowing anything about who you are. For more information, see the web page at www.gracenote.com for the Gracenote Privacy Policy.

THE GRACENOTE SOFTWARE, EACH ITEM OF GRACENOTE DATA AND THE GRACENOTE CONTENT ARE LICENSED TO YOU "AS IS". NEITHER GRACENOTE MAKES ANY REPRESENTATIONS OR WARRANTIES, EXPRESS OR IMPLIED, REGARDING THE ACCURACY OF ANY GRACENOTE DATA FROM THE GRACENOTE SERVERS OR GRACENOTE CONTENT. GRACENOTE COLLECTIVELY AND SEPARATELY RESERVE THE RIGHT TO DELETE DATA AND/OR CONTENT FROM THE COMPANIES' RESPECTIVE SERVERS OR, IN THE CASE OF GRACENOTE, CHANGE DATA CATEGORIES FOR ANY CAUSE THAT GRACENOTE DEEMS SUFFICIENT. NO WARRANTY IS MADE THAT EITHER GRACENOTE CONTENT OR THE GRACENOTE SOFTWARE OR GRACENOTE SERVERS ARE ERROR-FREE OR THAT THE FUNCTIONING OF THE GRACENOTE SOFTWARE OR GRACENOTE SERVERS WILL BE UNINTERRUPTED. GRACENOTE IS NOT OBLIGATED TO PROVIDE YOU WITH ANY ENHANCED OR ADDITIONAL DATA TYPES THAT GRACENOTE MAY CHOOSE TO PROVIDE IN THE FUTURE AND IS FREE TO DISCONTINUE ITS ONLINE SERVICES AT ANY TIME. GRACENOTE DISCLAIMS ALL WARRANTIES EXPRESS OR IMPLIED, INCLUDING, BUT NOT LIMITED TO,

IMPLIED WARRANTIES OF MERCHANTABILITY, FITNESS FOR A PARTICULAR PURPOSE, TITLE, AND NON-INFRINGEMENT. NEITHER GRACENOTE WARRANTS THE RESULTS THAT WILL BE OBTAINED BY YOUR USE OF THE GRACENOTE SOFTWARE OR ANY GRACENOTE SERVER. IN NO CASE WILL GRACENOTE BE LIABLE FOR ANY CONSEQUENTIAL OR INCIDENTAL DAMAGES OR FOR ANY LOST PROFITS OR LOST REVENUES FOR ANY REASON WHATSOEVER. © Gracenote 2007.

Taiwan Territory

Note: In accordance with the management approach of low-power radio wave radiation motors:

Article 12: For approved and certified low-power radiation motor models, companies, firms or users must not alter the frequency, increase the power or change the characteristics and functions of the original design without authorization.

Article 14: The usage of low-power radio-frequency motors must not affect aviation safety and interfere with legal telecommunications. Should interference be detected, immediately stop using the device and only resume usage after ensuring that there is no longer any interference. For the legal telecommunication and wireless telecommunication of the telco, the low-power radio frequency motor must be able to tolerate legal limits of interference from telecommunication, industrial, scientific and radio wave equipment.

Customer Information

SUNA TRAFFIC CHANNEL – TERMS AND CONDITIONS

By activating, using and/or accessing the SUNA Traffic Channel, SUNA Predictive or other content or material provided by Intelematics (together, **SUNA Products and/or Services**), you must accept certain terms and conditions. The following is a brief summary of the terms and conditions that apply to you. To view the full terms and conditions relevant to your use of the SUNA Products and/or Services, please consult:

| Website |
|--|
| www.sunattraffic.com.au/termsandconditions/ |

1. Acceptance

By using SUNA Products and/or Services, you will be deemed to have accepted and agreed to be bound by the terms and conditions fully detailed at:

| Website |
|--|
| www.sunattraffic.com.au/termsandconditions/ |

2. Intellectual Property

SUNA Products and/or Services are for your personal use. You may not record, or retransmit the content, nor use the content in association with any other traffic information or route guidance service or device not approved by Intelematics. You obtain no right of ownership in any Intellectual Property Rights (including copyright) in the data that is used to provide SUNA Products and/or Services.

3. Appropriate Use

SUNA Products and/or Services are intended as an aid to personal motoring and travel planning, and do not provide comprehensive or accurate information on all occasions. On occasions, you may experience additional delay as a result of using SUNA Products and/or Services. You acknowledge that it is not intended, or suitable, for use in applications where time of arrival or driving directions may impact the safety of the public or yourself.

4. Use of SUNA Products and Services while driving

You, and other authorized drivers of the vehicle in which SUNA Products and/or Services are available or installed and active, remain at all times responsible for observing all relevant laws and codes of safe driving. In particular, you agree to only actively operate SUNA Products and/or Services when the Vehicle is at a complete stop and it is safe to do so.

5. Service Continuity and Reception of the SUNA Traffic Channel

We will use reasonable endeavors to provide the SUNA Traffic Channel 24 hours a day, 365 days a year. The SUNA Traffic Channel may occasionally be unavailable for technical reasons or for planned maintenance. We will try to perform maintenance at times when congestion is light. We reserve the right to withdraw SUNA Products and/or Services at any time.

Also, we cannot assure the uninterrupted reception of the SUNA Traffic Channel RDS-TMC signal at any particular location.

6. Limitation of Liability

Neither Intelematics (nor its suppliers or the manufacturer of your device (the **"Suppliers"**)) shall be liable to you or to any third party for any damages either direct, indirect, incidental, consequential or otherwise arising out of the use of or inability to use SUNA Products and/or

Customer Information

Services even if Intelematics or a Supplier has been advised of the possibility of such damages. You also acknowledge that the neither Intelematics nor any Supplier guarantees nor make any warranties that relate to the availability, accuracy or completeness of SUNA Products and/or Services, and to the extent which it is lawful to do so, both Intelematics and each Supplier excludes any warranties which might otherwise be implied by any State or Federal legislation in relation to SUNA Products and/or Services.

7. Please Note

Great care has been taken in preparing this manual. Constant product development may mean that some information is not entirely up-to-date. The information in this document is subject to change without notice.

EMISSION LAW



WARNING: Do not remove or alter the original equipment floor covering or insulation between it and the metal floor of the vehicle. The floor covering and insulation protect occupants of the vehicle from the engine and exhaust system heat and noise. On vehicles with no original equipment floor covering insulation, do not carry passengers in a manner that permits prolonged skin contact with the metal floor. Failure to follow these instructions may result in fire or personal injury.

U.S. federal laws and certain state laws prohibit removing or rendering inoperative emission control system components. Similar federal or provincial laws may apply in Canada. We do not approve of any vehicle modification without first determining applicable laws.



Tampering with emissions control systems including related sensors or the Diesel Exhaust Fluid system can result in reduced engine power and the illumination of the service engine soon light.

Tampering With a Noise Control System

Federal laws prohibit the following acts:

- Removal or rendering inoperative by any person other than for purposes of maintenance.
- Repair or replacement of any device or element of the design incorporated into a new vehicle for the purpose of noise control prior to its sale or delivery to the ultimate purchaser or while it is in use.
- The use of the vehicle after any person removes or renders inoperative any device or element of the design.

The U.S. Environmental Protection Agency may presume to constitute tampering as follows:

- Removal of hood blanket, fender apron absorbers, fender apron barriers, underbody noise shields or acoustically absorptive material.
- Tampering or rendering inoperative the engine speed governor, to allow engine speed to exceed manufacturer specifications.

If the engine does not start, runs rough, experiences a decrease in engine performance, experiences excess fuel consumption or produces excessive exhaust smoke, check for the following:

- A plugged or disconnected air inlet system hose.
- A plugged engine air filter element.
- Water in the fuel filter and water separator.

Customer Information

- A clogged fuel filter.
- Contaminated fuel.
- Air in the fuel system, due to loose connections.
- An open or pinched sensor hose.
- Incorrect engine oil level.
- Incorrect fuel for climatic conditions.
- Incorrect engine oil viscosity for climactic conditions.

Note: *Some vehicles have a lifetime fuel filter that is integrated with the fuel tank. Regular maintenance or replacement is not needed.*

Note: *If these checks do not help you correct the concern, have your vehicle checked as soon as possible.*

Noise Emissions Warranty, Prohibited Tampering Acts and Maintenance

On January 1, 1978, Federal regulation became effective governing the noise emission on trucks over 10,000 lb (4,536 kg) Gross Vehicle Weight Rating (GVWR). The preceding statements concerning prohibited tampering acts and maintenance, and the noise warranty found in the Warranty Guide, are applicable to complete chassis cabs over 10,000 lb (4,536 kg) GVWR.

EXPORT UNIQUE OPTIONS

For your particular global region, your vehicle may be equipped with features and options that are different from the features and options that are described in this Owner's Manual. A market unique supplement may be supplied that complements this book. By referring to the market unique supplement, if provided, you can properly identify those features, recommendations and specifications that are unique to your vehicle. This Owner's

Manual is written primarily for the U.S. and Canadian markets. Features or equipment listed as standard may be different on units built for export. **Refer to this Owner's Manual for all other required information and warnings.**

Appendices

ELECTROMAGNETIC COMPATIBILITY



WARNING: Do not place objects or mount equipment on or near the airbag cover, on the side of the front or rear seatbacks, or in areas that may come into contact with a deploying airbag. Failure to follow these instructions may increase the risk of personal injury in the event of a crash.



WARNING: Do not fasten antenna cables to vehicle wiring, fuel pipes and brake pipes.



WARNING: Keep antenna and power cables at least 4 in (10 cm) from any electronic modules and airbags.

Note: We test and certify your vehicle to meet electromagnetic compatibility legislation. It is your responsibility to make sure that any equipment an authorized dealer installs on your vehicle complies with applicable local legislation and other requirements. Installation of some aftermarket electronic devices could degrade the performance of vehicle functions, which use radio frequency signals such as broadcast radio receiver, tire pressure monitoring system, push button start, **Bluetooth®** connectivity or satellite navigation.

Note: Any radio frequency transmitter equipment in your vehicle (such as cellular telephones and amateur radio transmitters) must keep to the parameters in the following illustrations and table. We do not provide any other special provisions or conditions for installations or use.

Car/SUV

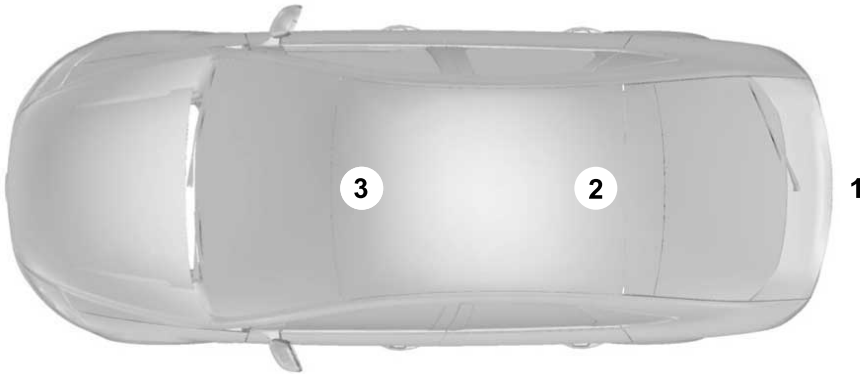

Appendices

Van

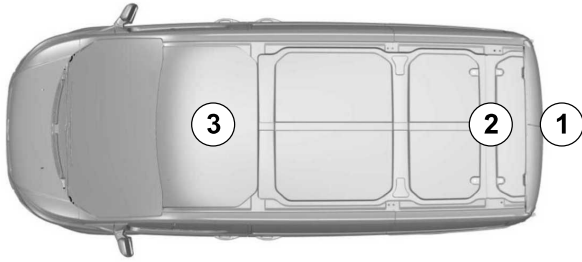

Truck

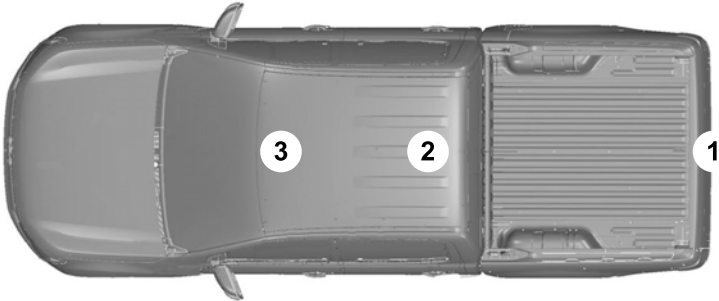

Appendices

| Frequency Band MHz | Maximum Output Power Watt (Peak RMS) | Antenna Positions |
|-------------------------------|---|--------------------------|
| 1-30 | 50 | 1 |
| 50-54 | 50 | 2, 3 |
| 68-88 | 50 | 2, 3 |
| 142-176 | 50 | 2, 3 |
| 380-512 | 50 | 2, 3 |
| 806-870 | 10 | 2, 3 |

Index

3

| | |
|---|-----|
| 360 Degree Camera..... | 321 |
| 360 Degree Camera Settings..... | 323 |
| 360 Degree Camera Guide Lines..... | 322 |
| 360 Degree Camera Limitations..... | 321 |
| 360 Degree Camera Precautions..... | 321 |
| 360 Degree Camera Settings..... | 323 |
| Switching the 360 Degree Camera On and Off..... | 323 |
| Switching the 360 Degree Camera View..... | 324 |

4

| | |
|----------------------------|-----|
| 4WD | |
| See: Four-Wheel Drive..... | 269 |

9

| | |
|-----------------|----|
| 911 Assist..... | 85 |
|-----------------|----|

A

A/C

| | |
|--|-----|
| See: Climate Control - Vehicles With: Automatic Temperature Control..... | 181 |
| See: Climate Control - Vehicles With: Manual Temperature Control..... | 186 |
| About This Publication..... | 22 |
| About Us..... | 19 |
| ABS | |
| See: Brakes..... | 286 |
| Accessing Apps..... | 626 |
| Accessing Navigation..... | 630 |
| Accessing the Passive Key Backup Position..... | 237 |
| Accessories..... | 635 |
| Active Park Assist..... | 325 |
| Active Park Assist – Troubleshooting..... | 327 |
| Active Park Assist Precautions..... | 325 |
| Active Park Assist – Troubleshooting..... | 327 |
| Active Park Assist – Frequently Asked Questions..... | 327 |
| Active Park Assist – Information Messages..... | 327 |

| | |
|--|-----|
| Adaptive Cruise Control..... | 331 |
| Adaptive Cruise Control – Troubleshooting..... | 341 |
| Intelligent Adaptive Cruise Control..... | 340 |
| Lane Centering..... | 338 |
| Adaptive Cruise Control Automatic Cancellation..... | 334 |
| Adaptive Cruise Control Indicators..... | 337 |
| Adaptive Cruise Control Limitations..... | 332 |
| Adaptive Cruise Control Precautions..... | 331 |
| Adaptive Cruise Control – Troubleshooting..... | 341 |
| Adaptive Cruise Control – Information Messages..... | 341 |
| Adaptive Front Lighting..... | 155 |
| How Does Adaptive Front Lighting Work..... | 155 |
| Switching Adaptive Front Lighting On and Off..... | 156 |
| Adjustable Pedals..... | 140 |
| Adjusting the Exterior Mirrors..... | 162 |
| Adjusting the Headlamps - Vehicles With: Halogen Headlamps..... | 497 |
| Adjusting the Headlamps - Vehicles With: LED Headlamps..... | 496 |
| Adjusting the Instrument Panel Lighting Brightness..... | 158 |
| Adjusting the Integrated Trailer Brake Controller Mode..... | 411 |
| Adjusting the Map..... | 630 |
| Changing the Format of the Map..... | 630 |
| Zooming the Map In and Out..... | 630 |
| Adjusting the Pedals..... | 140 |
| Adjusting the Seatbelt Height..... | 64 |
| Adjusting the Seatbelt Length..... | 65 |
| Adjusting the Seatbelts During Pregnancy..... | 64 |
| Adjusting the Sound Settings..... | 604 |
| Adjusting the Steering Wheel - Vehicles With: Manual Adjustable Steering Column..... | 138 |
| Adjusting the Steering Wheel - Vehicles With: Power Adjustable Steering Column..... | 138 |
| Adjusting the Volume..... | 604 |

Index

| | | | |
|--|-----|---|-----|
| Aid Mode..... | 363 | What Is the Anti-Theft Alarm System..... | 132 |
| How Does Aid Mode Work..... | 363 | What Is the Perimeter Alarm..... | 132 |
| What Is Aid Mode..... | 363 | Anti-Theft Alarm System Settings..... | 133 |
| Airbag Precautions..... | 72 | Setting the Alarm Security Level..... | 133 |
| Airbags..... | 70 | Switching Ask on Exit On and Off..... | 133 |
| Front Passenger Sensing System..... | 74 | What Are the Alarm Security Levels..... | 133 |
| Air Conditioning | | What Is Ask on Exit..... | 133 |
| See: Climate Control - Vehicles With: | | Appendices..... | 716 |
| Automatic Temperature Control..... | 181 | Applying the Electric Parking | |
| See: Climate Control - Vehicles With: Manual | | Brake..... | 289 |
| Temperature Control..... | 186 | Applying the Electric Parking Brake in an | |
| Air Conditioning System Capacity and | | Emergency..... | 289 |
| Specification - 2.7L EcoBoost™..... | 585 | App Precautions..... | 626 |
| Air Conditioning System Capacity and | | App Requirements..... | 626 |
| Specification - 3.3L..... | 586 | Apps..... | 626 |
| Air Conditioning System Capacity and | | At a Glance..... | 31 |
| Specification - 3.5L, Hybrid Electric | | Audio System..... | 603 |
| Vehicle (HEV)..... | 588 | AM/FM Radio..... | 605 |
| Air Conditioning System Capacity and | | Audio System – Troubleshooting..... | 610 |
| Specification - 3.5L EcoBoost™..... | 587 | Digital Radio..... | 606 |
| Air Conditioning System Capacity and | | Satellite Radio..... | 607 |
| Specification - 5.0L..... | 589 | Audio System Precautions..... | 603 |
| Alert and Aid Mode..... | 363 | Audio System – Troubleshooting..... | 610 |
| How Does Alert and Aid Mode Work..... | 364 | Audio System – Information | |
| What Is Alert and Aid Mode..... | 363 | Messages..... | 610 |
| Alert Mode..... | 362 | Auto-Dimming Exterior Mirror..... | 163 |
| Adjusting the Steering Wheel Vibration | | What Is the Auto-Dimming Exterior | |
| Intensity..... | 363 | Mirror..... | 163 |
| How Does Alert Mode Work..... | 363 | Auto-Dimming Interior Mirror..... | 161 |
| What Is Alert Mode..... | 362 | Auto-Dimming Interior Mirror | |
| AM/FM Radio..... | 605 | Limitations..... | 161 |
| AM/FM Radio Limitations..... | 605 | What Is the Auto-Dimming Interior | |
| Selecting a Radio Station..... | 605 | Mirror..... | 161 |
| Ambient Lighting..... | 158 | Auto Hold..... | 297 |
| Adjusting Ambient Lighting..... | 158 | Auto Hold Indicators..... | 297 |
| Switching Ambient Lighting On and | | Autolamps..... | 146 |
| Off..... | 158 | Autolamp Settings..... | 146 |
| Anti-Lock Braking System..... | 286 | What Are Autolamps..... | 146 |
| Anti-Lock Braking System | | Autolock..... | 103 |
| Limitations..... | 286 | Autolock Requirements..... | 103 |
| Anti-Theft Alarm System..... | 132 | What Is Autolock..... | 103 |
| Arming the Anti-Theft Alarm System..... | 133 | Automatically Releasing the Electric | |
| Disarming the Anti-Theft Alarm | | Parking Brake..... | 289 |
| System..... | 133 | Automatic Crash Shutoff..... | 466 |
| How Does the Anti-Theft Alarm System | | Automatic Crash Shutoff | |
| Work..... | 132 | Precautions..... | 466 |
| What Are the Inclination Sensors..... | 133 | Re-Enabling Your Vehicle..... | 466 |
| What Are the Interior Sensors..... | 132 | What Is Automatic Crash Shutoff..... | 466 |

Index

| | | | |
|---|-----|--|-----|
| Automatic Emergency Braking..... | 381 | Automatic Transmission..... | 260 |
| Switching Automatic Emergency Braking | | Automatic Return to Park (P)..... | 265 |
| On and Off..... | 381 | Automatic Transmission Positions..... | 260 |
| What Is Automatic Emergency | | Manually Shifting Gears..... | 262 |
| Braking..... | 381 | Manual Park Release..... | 267 |
| Automatic Engine Stop - Vehicles With: | | Temporary Neutral Mode..... | 264 |
| Keyless Entry and Push Button | | Automatic Transmission | |
| Start..... | 236 | Positions..... | 260 |
| How Does Automatic Engine Stop | | Drive (D)..... | 260 |
| Work..... | 237 | Manual (M)..... | 261 |
| Overriding Automatic Engine Stop..... | 237 | Neutral (N)..... | 260 |
| Switching Automatic Engine Stop On and | | Park (P)..... | 260 |
| Off..... | 237 | Reverse (R)..... | 260 |
| What Is Automatic Engine Stop..... | 236 | Automatic Transmission | |
| Automatic High Beam Control..... | 150 | Precautions..... | 260 |
| Automatic High Beam Control | | Auto Mode..... | 183 |
| Indicators..... | 152 | Auto Mode Indicators..... | 183 |
| Automatic High Beam Control | | Switching Auto Mode On and Off..... | 183 |
| Limitations..... | 151 | Switching Dual Mode On and Off..... | 184 |
| Automatic High Beam Control | | Auto-Start-Stop..... | 244 |
| Precautions..... | 151 | Auto-Start-Stop – Troubleshooting..... | 245 |
| Automatic High Beam Control | | Auto-Start-Stop Indicators..... | 244 |
| Requirements..... | 151 | Auto-Start-Stop Precautions..... | 244 |
| How Does Automatic High Beam Control | | Auto-Start-Stop – | |
| Work..... | 150 | Troubleshooting..... | 245 |
| Overriding Automatic High Beam | | Auto-Start-Stop – Frequently Asked | |
| Control..... | 152 | Questions..... | 246 |
| Switching Automatic High Beam Control | | Auto-Start-Stop – Information | |
| On and Off..... | 152 | Messages..... | 245 |
| Automatic High Beam Control – | | Auto-Start-Stop..... | 103 |
| Troubleshooting..... | 152 | Autounlock Requirements..... | 103 |
| Automatic High Beam Control – | | Switching Autounlock On and Off..... | 103 |
| Information Messages..... | 152 | What Is Autounlock..... | 103 |
| Automatic Locking Mode..... | 63 | Autowipers..... | 141 |
| Disengaging Automatic Locking Mode..... | 64 | Adjusting the Sensitivity of the Rain | |
| Engaging Automatic Locking Mode..... | 64 | Sensor..... | 141 |
| What Is Automatic Locking Mode..... | 63 | Autowipers Settings..... | 141 |
| When to Use Automatic Locking | | What Are Autowipers..... | 141 |
| Mode..... | 63 | Auxiliary Switches..... | 636 |
| Automatic Return to Park (P)..... | 265 | | |
| Automatic Return to Park (P) | | B | |
| Limitations..... | 265 | Base Warranty..... | 639 |
| How Does Automatic Return to Park (P) | | Battery | |
| Work..... | 265 | See: Changing the 12V Battery..... | 494 |
| What Is Automatic Return to Park | | Bed Extender..... | 113 |
| (P)..... | 265 | Bed Extender Precautions..... | 113 |
| Automatic Transmission Audible | | Using the Bed Extender..... | 114 |
| Warnings..... | 268 | | |

Index

| | | | |
|---|-----|--|-----|
| Beginning a Voice Interaction..... | 617 | Booster Seats..... | 58 |
| Blind Spot Information System..... | 368 | Brake Fluid Specification..... | 287 |
| Blind Spot Information System – Troubleshooting..... | 371 | Brake Over Accelerator..... | 286 |
| Blind Spot Information System With Trailer Coverage..... | 369 | Brake Over Accelerator - Raptor..... | 286 |
| Blind Spot Information System | | Brake Precautions..... | 286 |
| Indicators..... | 371 | Brakes..... | 286 |
| Blind Spot Information System | | Anti-Lock Braking System..... | 286 |
| Limitations..... | 368 | Brakes – Troubleshooting..... | 288 |
| Blind Spot Information System | | Brakes – Troubleshooting..... | 288 |
| Precautions..... | 368 | Brakes – Frequently Asked Questions..... | 288 |
| Blind Spot Information System | | Brakes – Warning Lamps..... | 288 |
| Requirements..... | 368 | Breaking-In..... | 455 |
| Blind Spot Information System – Troubleshooting..... | 371 | | |
| Blind Spot Information System – Information Messages..... | 371 | C | |
| Blind Spot Information System With Trailer Coverage..... | 369 | Calculating Payload..... | 391 |
| Blind Spot Information System With Trailer Coverage Limitations..... | 369 | Calculating the Load Limit..... | 391 |
| Selecting a Trailer..... | 371 | Canceling the Set Speed..... | 330 |
| Setting a Trailer Length..... | 370 | Canceling the Set Speed - Raptor..... | 303 |
| What Is Blind Spot Information System with Trailer Coverage..... | 369 | Capacities and Specifications..... | 558 |
| BlueCruise Alerts..... | 347 | Catalytic Converter..... | 258 |
| BlueCruise Automatic | | Catalytic Converter – Troubleshooting..... | 258 |
| Cancellation..... | 347 | Catalytic Converter Precautions..... | 258 |
| BlueCruise..... | 344 | Catalytic Converter – Troubleshooting..... | 258 |
| BlueCruise – Troubleshooting..... | 348 | Catalytic Converter – Warning Lamps..... | 258 |
| BlueCruise Indicators..... | 347 | Center Console Work Surface..... | 223 |
| BlueCruise Limitations..... | 345 | Center Console Work Surface – Troubleshooting..... | 225 |
| BlueCruise Precautions..... | 344 | Center Console Work Surface – Troubleshooting..... | 225 |
| BlueCruise Requirements..... | 345 | Center Console Work Surface – Information Messages..... | 225 |
| BlueCruise Settings..... | 346 | Center Display Limitations..... | 614 |
| BlueCruise – Troubleshooting..... | 348 | Center Display Overview..... | 614 |
| BlueCruise – Information Messages..... | 348 | Center Display Precautions..... | 614 |
| Bluetooth®..... | 625 | Changing a Flat Tire..... | 543 |
| Body Control Module Fuse Box..... | 478 | Changing a Flat Tire - Raptor/ Tremor..... | 549 |
| Accessing the Body Control Module Fuse Box..... | 478 | Changing a Road Wheel..... | 543 |
| Identifying the Fuses in the Body Control Module Fuse Box..... | 478 | Changing the 12V Battery..... | 494 |
| Locating the Body Control Module Fuse Box..... | 478 | Changing the Fuel Filter - Gasoline..... | 493 |
| Bonnet Lock | | Changing the Remote Control Battery - Police Responder..... | 89 |
| See: Opening and Closing the Hood..... | 482 | | |

Index

| | |
|---|-----|
| Changing the Remote Control Battery - Vehicles With: Flip Key..... | 92 |
| Changing the Remote Control Battery - Vehicles With: Push Button Start..... | 90 |
| Changing the Vehicle Wi-Fi Hotspot Name or Password..... | 601 |
| Charging a Device..... | 210 |
| Charging a Wireless Device..... | 226 |
| Checking MyKey System Status..... | 98 |
| Checking the Brake Fluid..... | 287 |
| Checking the Coolant..... | 489 |
| Checking the Seatbelts..... | 67 |
| Checking the Tire Pressures..... | 532 |
| Checking the Wiper Blades..... | 142 |
| Children and Airbags..... | 73 |
| Child Restraint Anchor Points..... | 48 |
| Locating the Child Restraint Lower Anchor Points..... | 48 |
| Locating the Child Restraint Top Tether Anchor Points..... | 49 |
| What Are the Child Restraint Anchor Points..... | 48 |
| Child Restraints..... | 50 |
| Child Restraint Position Information..... | 50 |
| Child Restraints Recommendation..... | 51 |
| Child Safety..... | 47 |
| Child Restraint Anchor Points..... | 48 |
| Child Restraints..... | 50 |
| Installing Child Restraints..... | 51 |
| Child Safety Locks..... | 60 |
| Child Safety Precautions..... | 47 |
| Cleaning Products..... | 511 |
| Cleaning the Exterior..... | 511 |
| Cleaning Camera Lenses and Sensors..... | 513 |
| Cleaning Chrome, Aluminium or Stainless Steel..... | 512 |
| Cleaning Headlamps and Rear Lamps..... | 512 |
| Cleaning Stripes or Graphics..... | 513 |
| Cleaning the Engine Compartment..... | 513 |
| Cleaning the Exterior Precautions..... | 511 |
| Cleaning the Underbody..... | 513 |
| Cleaning Wheels..... | 512 |
| Cleaning Windows and Wiper Blades..... | 512 |
| Cleaning the Interior..... | 513 |
| Cleaning Carpets and Floor Mats..... | 515 |
| Cleaning Displays and Screens..... | 514 |
| Cleaning Moonroof Tracks..... | 515 |
| Cleaning Plastic..... | 514 |
| Cleaning Seatbelts..... | 515 |
| Cleaning Seats and the Headliner..... | 514 |
| Cleaning the Instrument Panel..... | 513 |
| Clearing All MyKeys..... | 98 |
| Clearing the Garage Door Opener..... | 207 |
| Climate Control..... | 181 |
| Auto Mode..... | 183 |
| Climate Control Hints..... | 184 |
| Closing the Tailgate..... | 117 |
| Closing the Tailgate From Inside Your Vehicle..... | 117 |
| Closing the Tailgate From Outside Your Vehicle..... | 117 |
| Closing the Tailgate Using the Remote Control..... | 118 |
| Cold Weather Precautions..... | 455 |
| Connected Vehicle..... | 597 |
| Connected Vehicle - Troubleshooting..... | 598 |
| Connecting the Vehicle to a Mobile Network..... | 597 |
| Connected Vehicle Data..... | 29 |
| Connected Vehicle Limitations..... | 597 |
| Connected Vehicle Requirements..... | 597 |
| Connected Vehicle - Troubleshooting..... | 598 |
| Connected Vehicle - Frequently Asked Questions..... | 598 |
| Connecting a Bluetooth® Device..... | 625 |
| Connecting a Trailer..... | 399 |
| Connecting a Trailer - Troubleshooting..... | 402 |
| Hitches..... | 399 |
| Connecting a Trailer Precautions..... | 399 |
| Connecting a Trailer - Troubleshooting..... | 402 |
| Connecting a Trailer - Information Messages..... | 402 |
| Connecting the Vehicle to a Mobile Network..... | 597 |
| Connecting FordPass to the Modem..... | 597 |
| Enabling and Disabling the Modem..... | 597 |
| What Is the Modem..... | 597 |
| Connecting the Vehicle to a Wi-Fi Network..... | 597 |
| Connecting Your Phone..... | 620 |

Index

| | |
|--|-----|
| Contacting Us..... | 20 |
| Cooling System Capacity and Specification - 2.7L EcoBoost™..... | 578 |
| Cooling System Capacity and Specification - 3.3L..... | 579 |
| Cooling System Capacity and Specification - 3.5L, Hybrid Electric Vehicle (HEV)..... | 580 |
| Cooling System Capacity and Specification - 3.5L EcoBoost™..... | 579 |
| Cooling System Capacity and Specification - 5.0L..... | 581 |
| Cooling System Capacity and Specification - Raptor, Police Responder..... | 581 |
| Crash and Breakdown Information..... | 462 |
| Automatic Crash Shutoff..... | 466 |
| Jump Starting the Vehicle..... | 464 |
| Post-Crash Alert System..... | 466 |
| Recovery Towing..... | 467 |
| Crash Sensors and Airbag Indicator..... | 77 |
| Crash Sensors and Airbag Indicator - Police Responder..... | 78 |
| Creating a MyKey - Vehicles With: Flip Key..... | 98 |
| Creating a MyKey - Vehicles With: Push Button Start..... | 97 |
| Creating a Personal Profile..... | 629 |
| Creating a Vehicle Wi-Fi Hotspot..... | 601 |
| Cross Traffic Alert..... | 372 |
| Cross Traffic Alert - Troubleshooting..... | 374 |
| Cross Traffic Alert Indicators..... | 373 |
| Cross Traffic Alert Limitations..... | 372 |
| Cross Traffic Alert Precautions..... | 372 |
| Cross Traffic Alert - Troubleshooting..... | 374 |
| Cross Traffic Alert - Information Messages..... | 374 |
| Cruise Control..... | 329 |
| Cruise Control Indicators..... | 330 |
| Cup Holders..... | 227 |
| Cup Holder Precautions..... | 227 |
| Customer Information..... | 656 |
| Radio Frequency Certification Labels..... | 659 |
| Customizing the Instrument Cluster Display..... | 175 |
| D | |
| Data Privacy..... | 27 |
| Decommissioning Requirements..... | 655 |
| Decommissioning the Vehicle..... | 655 |
| Department of Transportation Uniform Tire Quality Grades..... | 519 |
| Deploying and Stowing the Power Running Boards..... | 137 |
| Digital Radio..... | 606 |
| Digital Radio Indicators..... | 607 |
| Digital Radio Limitations..... | 606 |
| How Does Digital Radio Work..... | 606 |
| Switching Digital Radio Reception On and Off..... | 607 |
| What Is Digital Radio..... | 606 |
| Directing the Flow of Air..... | 183 |
| Disposing of Airbags..... | 83 |
| Distance Alert..... | 380 |
| Adjusting the Sensitivity of Distance Alert..... | 381 |
| What Is Distance Alert..... | 380 |
| Distance Indication..... | 379 |
| Distance Indication Indicator..... | 380 |
| Switching Distance Indication On and Off..... | 380 |
| What Is Distance Indication..... | 379 |
| Doors and Locks Audible Warnings..... | 103 |
| Doors and Locks..... | 102 |
| Autolock..... | 103 |
| Autounlock..... | 103 |
| Doors and Locks - Troubleshooting..... | 104 |
| Mislock..... | 103 |
| Operating the Doors From Inside Your Vehicle..... | 102 |
| Operating the Doors From Outside Your Vehicle..... | 102 |
| Doors and Locks - Troubleshooting..... | 104 |
| Doors and Locks - Frequently Asked Questions..... | 105 |
| Doors and Locks - Information Messages..... | 104 |
| Doors and Locks - Warning Lamps..... | 104 |

Index

| | |
|--|-----|
| Drive Belt Routing - 2.7L EcoBoost™, Vehicles With: Dual Generators..... | 508 |
| Drive Belt Routing - 2.7L EcoBoost™, Vehicles With: Single Generator..... | 508 |
| Drive Belt Routing - 3.3L..... | 508 |
| Drive Belt Routing - 3.5L, Hybrid Electric Vehicle (HEV)..... | 509 |
| Drive Belt Routing - 3.5L Ecoboost™, Vehicles With: Dual Generators..... | 509 |
| Drive Belt Routing - 3.5L Ecoboost™, Vehicles With: Single Generator..... | 509 |
| Drive Belt Routing - 5.0L, Vehicles With: Dual Generators..... | 509 |
| Drive Belt Routing - 5.0L, Vehicles With: Single Generator..... | 510 |
| Drive Mode Control..... | 350 |
| Drive Mode Control - Troubleshooting..... | 359 |
| Drive Modes..... | 352 |
| Drive Mode Control - Troubleshooting..... | 359 |
| Drive Mode Control - Frequently Asked Questions..... | 360 |
| Drive Mode Control - Information Messages..... | 359 |
| Drive Mode Control - Warning Lamps..... | 359 |
| Drive Modes..... | 352 |
| Baja..... | 352 |
| Deep Snow/Sand..... | 353 |
| Eco..... | 353 |
| Mud/Ruts..... | 353 |
| Normal..... | 353 |
| Off-Road..... | 354 |
| Rock Crawl..... | 355 |
| Slippery..... | 355 |
| Sport..... | 356 |
| Tow/Haul..... | 357 |
| Trail..... | 358 |
| Driver Alert..... | 386 |
| Driver Alert - Troubleshooting..... | 387 |
| Driver Alert Limitations..... | 386 |
| Driver Alert Precautions..... | 386 |
| Driver Alert - Troubleshooting..... | 387 |
| Driver Alert - Information Messages..... | 387 |
| Driving Economically..... | 455 |
| Driving Hints..... | 449 |
| Driving in Special Conditions..... | 456 |
| Off-Road Driving..... | 449 |
| Driving in Special Conditions..... | 456 |
| Emergency Maneuvers..... | 456 |
| Driving on Snow and Ice..... | 455 |
| E | |
| Easy Entry and Exit..... | 110 |
| Eco Idle..... | 242 |
| How Does Eco Idle Work..... | 242 |
| Switching Eco Idle On and Off..... | 242 |
| What Is Eco Idle..... | 242 |
| Eco Idle - Troubleshooting..... | 243 |
| Eco Idle - Frequently Asked Questions..... | 243 |
| Electric Parking Brake Audible Warning..... | 290 |
| Electric Parking Brake..... | 289 |
| Electric Parking Brake - Troubleshooting..... | 290 |
| Electric Parking Brake - Troubleshooting..... | 290 |
| Electric Parking Brake - Information Messages..... | 291 |
| Electric Parking Brake - Warning Lamps..... | 290 |
| Electric Power Steering..... | 311 |
| Electric Power Steering Adaptive Steering..... | 311 |
| Electric Power Steering Precautions..... | 311 |
| Electromagnetic Compatibility..... | 716 |
| Electronic Locking Differential..... | 279 |
| Electronic Locking Differential - Troubleshooting..... | 284 |
| Electronic Locking Differential Indicators..... | 283 |
| Electronic Locking Differential Precautions..... | 279 |
| Electronic Locking Differential - Troubleshooting..... | 284 |
| Electronic Locking Differential - Information Messages..... | 284 |
| Emergency Call Limitations..... | 86 |
| Emergency Call Requirements..... | 85 |
| Emergency Call System Data..... | 30 |
| Emergency Towing..... | 471 |
| Emission Law..... | 714 |

Index

| | |
|--|-----|
| Enabling Apps on an Android Device..... | 626 |
| Enabling Apps on an iOS Device..... | 626 |
| Enabling or Disabling Personal Profiles..... | 628 |
| Enabling Remote Start..... | 178 |
| End User License Agreement..... | 689 |
| Engine Air Filter..... | 493 |
| Changing the Engine Air Filter..... | 493 |
| Engine Block Heater..... | 234 |
| Engine Block Heater Precautions..... | 234 |
| How Does the Engine Block Heater Work..... | 235 |
| Using the Engine Block Heater..... | 235 |
| Engine Coolant Temperature Gauge..... | 169 |
| Engine Oil Capacity and Specification - 2.7L EcoBoost™..... | 569 |
| Engine Oil Capacity and Specification - 3.3L..... | 570 |
| Engine Oil Capacity and Specification - 3.5L, Hybrid Electric Vehicle (HEV)..... | 574 |
| Engine Oil Capacity and Specification - 3.5L EcoBoost™..... | 572 |
| Engine Oil Capacity and Specification - 5.0L..... | 576 |
| Engine Oil..... | 488 |
| Adding Engine Oil..... | 488 |
| Checking the Engine Oil Level..... | 488 |
| Engine Oil Capacity and Specification..... | 489 |
| Engine Oil Dipstick Overview..... | 488 |
| Resetting the Engine Oil Change Reminder..... | 488 |
| Engine Oil Pressure Gauge..... | 169 |
| Engine Specifications - 2.7L EcoBoost™..... | 558 |
| Engine Specifications - 3.3L..... | 559 |
| Engine Specifications - 3.5L, Hybrid Electric Vehicle (HEV)..... | 561 |
| Engine Specifications - 3.5L EcoBoost™..... | 560 |
| Engine Specifications - 5.0L..... | 562 |
| Entering a Parallel Parking Space..... | 325 |
| Entering a Perpendicular Parking Space..... | 326 |
| Evasive Steering Assist..... | 381 |
| Evasive Steering Assist Limitations..... | 381 |
| Switching Evasive Steering Assist On and Off..... | 382 |
| What Is Evasive Steering Assist..... | 381 |
| Event Data..... | 28 |
| Exiting a Parking Space..... | 326 |
| Export Unique Options..... | 715 |
| Extending the Exterior Mirrors..... | 163 |
| Extending the Remote Start Duration..... | 179 |
| Exterior Bulbs..... | 499 |
| Changing a Front Fog Lamp Bulb..... | 505 |
| Changing a Front Side Marker Lamp Bulb..... | 504 |
| Changing a Front Turn Signal Lamp Bulb..... | 503 |
| Changing a Headlamp Bulb..... | 501 |
| Changing a High Mounted Stoplamp Bulb..... | 507 |
| Changing a License Plate Lamp Bulb..... | 507 |
| Changing a Rear Lamp Bulb..... | 505 |
| Changing a Rear Turn Signal Lamp Bulb..... | 506 |
| Changing a Reversing Lamp Bulb..... | 507 |
| Changing a Stoplamp Bulb..... | 506 |
| Exterior Bulb Specification Chart..... | 499 |
| Removing a Rear Lamp Assembly..... | 501 |
| Exterior Lamps..... | 147 |
| Exterior Lamp Audible Warning..... | 149 |
| Exterior Lamp Indicators..... | 149 |
| How Do Cornering Lamps Work..... | 147 |
| Switching the Cargo Lamps On..... | 148 |
| Switching the Daytime Running Lamps On and Off..... | 147 |
| Switching the Front Fog Lamps On and Off..... | 148 |
| Switching the Spot Lamps On and Off..... | 149 |
| Switching the Turn Signal Lamps On and Off..... | 147 |
| Exterior Lighting Control..... | 145 |
| Exterior Lighting Control - Police Responder..... | 145 |
| Exterior Lighting..... | 145 |
| Adaptive Front Lighting..... | 155 |
| Autolamps..... | 146 |
| Automatic High Beam Control..... | 150 |

Index

| | |
|--|-----|
| Automatic High Beam Control – Troubleshooting..... | 152 |
| Exterior Lamps..... | 147 |
| Exterior Zone Lighting..... | 149 |
| Glare Free Lighting..... | 153 |
| Glare Free Lighting – Troubleshooting..... | 155 |
| Headlamps..... | 145 |
| Headlamps – Troubleshooting..... | 146 |
| Exterior Mirrors..... | 162 |
| Auto-Dimming Exterior Mirror..... | 163 |
| Exterior Zone Lighting..... | 149 |
| Exterior Zone Lighting Settings..... | 150 |
| Using the Exterior Zone Lighting..... | 149 |
| What Is Exterior Zone Lighting..... | 149 |
| F | |
| Fastening and Unfastening the Seatbelts..... | 62 |
| Feature Bar..... | 615 |
| Flat Tire See: Changing a Flat Tire..... | 543 |
| See: Changing a Flat Tire - Raptor/ Tremor..... | 549 |
| Floor Mats..... | 456 |
| Folding the Exterior Mirrors - Vehicles With: Manual Folding Mirrors..... | 162 |
| Folding the Exterior Mirrors - Vehicles With: Power Folding Mirrors..... | 162 |
| Foot Pedals See: Adjusting the Pedals..... | 140 |
| Ford Performance..... | 19 |
| Ford Protect..... | 640 |
| Four-Wheel Drive..... | 269 |
| Four-Wheel Drive Modes..... | 273 |
| Four-Wheel Drive – Troubleshooting..... | 274 |
| Four-Wheel Drive Indicators..... | 274 |
| Four-Wheel Drive Limitations..... | 270 |
| Four-Wheel Drive Modes..... | 273 |
| Four-Wheel Drive Auto..... | 273 |
| Four-Wheel Drive High..... | 273 |
| Four-Wheel Drive Low..... | 274 |
| Two-Wheel Drive High..... | 273 |
| Four-Wheel Drive Precautions..... | 270 |
| Four-Wheel Drive – Troubleshooting..... | 274 |
| Four-Wheel Drive – Information..... | 275 |
| Four-Wheel Drive – Warning Lamps..... | 274 |
| Front Axle Fluid Capacity and Specification..... | 592 |
| Front Exterior..... | 41 |
| Front Exterior - Police Responder..... | 43 |
| Front Exterior - Raptor..... | 42 |
| Front Parking Aid..... | 314 |
| Front Parking Aid Audible Warnings..... | 315 |
| Front Parking Aid Limitations..... | 315 |
| Locating the Front Parking Aid Sensors..... | 315 |
| What is the Front Parking Aid..... | 314 |
| Front Passenger Sensing System..... | 74 |
| Front Passenger Sensing System Indicators..... | 76 |
| Front Passenger Sensing System Precautions..... | 76 |
| How Does the Front Passenger Sensing System Work..... | 74 |
| What Is the Front Passenger Sensing System..... | 74 |
| Front Seat Precautions..... | 190 |
| Front Seats..... | 190 |
| Heated Seats..... | 197 |
| Manual Seats..... | 191 |
| Massage Seats..... | 196 |
| Power Seats..... | 193 |
| Ventilated Seats..... | 197 |
| Fuel and Refueling..... | 247 |
| Fuel and Refueling – Troubleshooting..... | 257 |
| Fuel Quality..... | 248 |
| Refueling..... | 251 |
| Running Out of Fuel..... | 250 |
| Fuel and Refueling Precautions..... | 247 |
| Fuel and Refueling – Troubleshooting..... | 257 |
| Fuel and Refueling – Information Messages..... | 257 |
| Fuel and Refueling – Warning Lamps..... | 257 |
| Fuel Gauge..... | 168 |
| Fuel Gauge Limitations..... | 169 |
| Locating the Fuel Filler Door..... | 169 |
| What Is Distance to Empty..... | 169 |

Index

| | | | |
|---|-----|---|-----|
| What Is the Fuel Gauge..... | 168 | Glove Compartment..... | 227 |
| What Is the Low Fuel Reminder..... | 169 | Locking the Glove Compartment..... | 227 |
| Fuel Quality..... | 248 | Opening the Glove Compartment..... | 227 |
| Selecting the Correct Fuel..... | 248 | | |
| Switching Between E85 and Gasoline..... | 249 | H | |
| Fuel Tank Capacity - Excluding: Hybrid Electric Vehicle (HEV)..... | 256 | Headlamp Adjusting | |
| Fuel Tank Capacity - Gasoline, Excluding: Hybrid Electric Vehicle (HEV)..... | 583 | See: Adjusting the Headlamps - Vehicles With: Halogen Headlamps..... | 497 |
| Fuel Tank Capacity - Gasoline, Hybrid Electric Vehicle (HEV)..... | 582 | See: Adjusting the Headlamps - Vehicles With: LED Headlamps..... | 496 |
| Fuel Tank Capacity - Hybrid Electric Vehicle (HEV)..... | 257 | Headlamps..... | 145 |
| Fuel Tank Capacity - Raptor..... | 584 | Headlamp Indicators..... | 145 |
| Fuse Precautions..... | 472 | Using the High Beam Headlamps..... | 145 |
| Fuses..... | 472 | Headlamps – Troubleshooting..... | 146 |
| Body Control Module Fuse Box..... | 478 | Headlamps – Frequently Asked Questions..... | 146 |
| Fuses – Troubleshooting..... | 481 | Heated Seats..... | 197 |
| Under Hood Fuse Box..... | 472 | Heated Seat Precautions..... | 197 |
| Fuses – Troubleshooting..... | 481 | Switching the Heated Seats On and Off..... | 197 |
| Fuses – Frequently Asked Questions..... | 481 | Heating | |
| | | See: Climate Control - Vehicles With: Automatic Temperature Control..... | 181 |
| G | | See: Climate Control - Vehicles With: Manual Temperature Control..... | 186 |
| Garage Door Opener..... | 205 | High Voltage Battery..... | 259 |
| Garage Door Opener Limitations..... | 205 | High Voltage Battery Precautions..... | 259 |
| Garage Door Opener Precautions..... | 205 | High Voltage Battery Vehicle Precautions - Hybrid Electric Vehicle (HEV)..... | 463 |
| Garage Door Opener Radio Frequencies..... | 208 | Hill Descent Control..... | 309 |
| General Maintenance Information..... | 642 | Hill Descent Control – Troubleshooting..... | 310 |
| Glare Free Lighting..... | 153 | Hill Descent Control Indicator..... | 309 |
| Glare Free Lighting Indicators..... | 154 | Hill Descent Control Precautions..... | 309 |
| Glare Free Lighting Limitations..... | 154 | Hill Descent Control – Troubleshooting..... | 310 |
| Glare Free Lighting Precautions..... | 153 | Hill Descent Control – Information Messages..... | 310 |
| Glare Free Lighting Requirements..... | 153 | Hill Start Assist..... | 296 |
| How Does Glare Free Lighting Work..... | 153 | Hill Start Assist – Troubleshooting..... | 296 |
| Overriding Glare Free Lighting..... | 154 | Hill Start Assist Precautions..... | 296 |
| Switching Glare Free Lighting On and Off..... | 154 | Hill Start Assist – Troubleshooting..... | 296 |
| Glare Free Lighting – Troubleshooting..... | 155 | Hill Start Assist – Information Messages..... | 296 |
| Glare Free Lighting – Information Messages..... | 155 | | |
| Glasses Holder..... | 230 | | |
| Locating the Glasses Holder..... | 230 | | |
| Glossary of Tire Terminology..... | 525 | | |

Index

| | | | |
|---|-----|---|-----|
| Hitches..... | 399 | How Does the Rear Occupant Alert System Work..... | 202 |
| Hooking Up a Trailer Using a Weight-Distributing Hitch..... | 399 | How Does the Safety Canopy™ Work..... | 71 |
| Hood Lock | | How Does Traction Control Work..... | 298 |
| See: Opening and Closing the Hood..... | 482 | How Does Trailer Backup Assistance Work..... | 422 |
| Horn..... | 139 | How Does Trailer Hitching Assistance Work..... | 415 |
| How Does 911 Assist Work..... | 85 | How Does Trailer Reverse Guidance Work..... | 437 |
| How Does Active Park Assist Work..... | 325 | How Does Trailer Sway Control Work..... | 414 |
| How Does Adaptive Cruise Control With Stop and Go Work..... | 331 | How Do Personal Profiles Work..... | 628 |
| How Does a Hybrid Electric Vehicle Work..... | 241 | How Do the Front Airbags Work..... | 70 |
| How Does Auto Hold Work..... | 297 | How Do the Knee Airbags Work..... | 71 |
| How Does Blind Spot Information System Work..... | 368 | How Do the Side Airbags Work..... | 70 |
| How Does BlueCruise Work..... | 344 | Hybrid Display Information..... | 176 |
| How Does Cross Traffic Alert Work..... | 372 | How Does EV Coach Work..... | 176 |
| How Does Drive Mode Control Work..... | 350 | What Is EV Coach..... | 176 |
| How Does Driver Alert Work..... | 386 | Hybrid Electric Vehicle Driving Characteristics..... | 241 |
| How Does Easy Entry and Exit Work..... | 110 | Hybrid Electric Vehicle Indicators..... | 241 |
| How Does Four-Wheel Drive Work..... | 269 | Hybrid Electric Vehicle Information..... | 241 |
| How Does Four-Wheel Drive Work - Raptor..... | 269 | Eco Idle..... | 242 |
| How Does Hill Descent Control Work..... | 309 | Eco Idle – Troubleshooting..... | 243 |
| How Does Hill Start Assist Work..... | 296 | Hybrid Electric Vehicle Information – Troubleshooting..... | 242 |
| How Does On-Board Scale Work..... | 420 | Hybrid Electric Vehicle Information – Troubleshooting..... | 242 |
| How Does Pre-Collision Assist Work..... | 375 | Hybrid Electric Vehicle Information – Frequently Asked Questions..... | 242 |
| How Does Reverse Braking Assist Work..... | 292 | | |
| How Does Smart Hitch Work..... | 418 | Identifying Fuse Types..... | 481 |
| How Does Stability Control Work..... | 300 | Identifying the Audio Unit..... | 603 |
| How Does the 360 Degree Camera Work..... | 321 | Identifying the Auxiliary Switch Wiring..... | 637 |
| How Does the Electronic Locking Differential Work..... | 279 | Identifying the Climate Control Unit..... | 181 |
| How Does the Electronic Locking Differential Work - Raptor..... | 279 | Ignition Switch..... | 231 |
| How Does the Garage Door Opener Work..... | 205 | Inflating the Tires..... | 532 |
| How Does the Lane Keeping System Work..... | 361 | Information On Demand Screen - Vehicles With: 12.3 Inch Screen..... | 616 |
| How Does the Personal Safety System Work..... | 69 | Information on the Tire Sidewall..... | 520 |
| | | Inspecting the Tire for Damage..... | 533 |
| | | Inspecting the Tire for Wear..... | 533 |

Index

| | |
|---|-----|
| Inspecting the Wheel Valve Stems..... | 534 |
| Installing Child Restraints..... | 51 |
| Attaching the Front Seat Tether Strap..... | 56 |
| Attaching the Rear Seat Tether Strap..... | 57 |
| Combining the Seatbelt and Lower Anchors for Attaching Child Restraints..... | 56 |
| Installing a Child Restraint in a Center Seat..... | 55 |
| Using Lower Anchors and Tethers for Children..... | 55 |
| Using Seatbelts..... | 51 |
| Using Tether Straps..... | 56 |
| Instrument Cluster Display..... | 173 |
| Hybrid Display Information..... | 176 |
| Personalized Settings..... | 176 |
| Trip Computer - Vehicles With: 4.2 Inch Screen..... | 175 |
| Trip Computer - Vehicles With: 8 Inch Screen/12.3 Inch Screen..... | 175 |
| Instrument Cluster Display Main Menu - Raptor..... | 174 |
| Instrument Cluster Display Main Menu - Vehicles With: 12.3 Inch Screen..... | 173 |
| Instrument Cluster Display Main Menu - Vehicles With: 4.2 Inch Screen..... | 174 |
| Instrument Cluster Display Main Menu - Vehicles With: 8 Inch Screen..... | 174 |
| Instrument Cluster Indicators..... | 171 |
| Instrument Cluster..... | 166 |
| Fuel Gauge..... | 168 |
| Instrument Cluster Overview - Vehicles With: 12.3 Inch Screen..... | 168 |
| Instrument Cluster Overview - Vehicles With: 4.2 Inch Screen..... | 166 |
| Instrument Cluster Overview - Vehicles With: 8 Inch Screen..... | 167 |
| Instrument Cluster Warning Lamps..... | 169 |
| Instrument Panel..... | 35 |
| Instrument Panel - Police Responder..... | 37 |
| Instrument Panel - Raptor..... | 36 |
| Integrated Trailer Brake Controller..... | 410 |
| Integrated Trailer Brake Controller - Troubleshooting..... | 412 |
| Integrated Trailer Brake Controller Precautions..... | 410 |
| Integrated Trailer Brake Controller - Troubleshooting..... | 412 |
| Integrated Trailer Brake Controller - Frequently Asked Questions..... | 413 |
| Integrated Trailer Brake Controller - Information Messages..... | 412 |
| Intelligent Adaptive Cruise Control..... | 340 |
| Adjusting the Set Speed Tolerance..... | 341 |
| How Does Intelligent Adaptive Cruise Control Work..... | 340 |
| Intelligent Adaptive Cruise Control Alerts..... | 341 |
| Intelligent Adaptive Cruise Control Indicators..... | 341 |
| Intelligent Adaptive Cruise Control Limitations..... | 341 |
| Intelligent Adaptive Cruise Control Precautions..... | 340 |
| Intelligent Adaptive Cruise Control Requirements..... | 340 |
| Switching Intelligent Mode On and Off..... | 341 |
| Interior Air Quality..... | 189 |
| Interior Bulbs..... | 508 |
| Interior Bulb Specification Chart..... | 508 |
| Interior Lamp Function..... | 158 |
| Switching the Interior Lamp Function On and Off..... | 158 |
| What Is the Interior Lamp Function..... | 158 |
| Interior Lighting..... | 157 |
| Ambient Lighting..... | 158 |
| Interior Lamp Function..... | 158 |
| Interior Lighting - Troubleshooting..... | 158 |
| Interior Lighting - Troubleshooting..... | 158 |
| Interior Lighting - Frequently Asked Questions..... | 158 |
| Interior Mirror..... | 161 |
| Auto-Dimming Interior Mirror..... | 161 |
| Interior Mirror Precautions..... | 161 |
| Introduction..... | 22 |
| J | |
| Jump Starting the Vehicle..... | 464 |
| Jump Starting Precautions..... | 464 |

Index

| | |
|--|-----|
| Jump Starting the Vehicle..... | 465 |
| Preparing the Vehicle..... | 464 |
| K | |
| Keyless Entry..... | 106 |
| Keyless Entry – Troubleshooting..... | 107 |
| Keyless Entry Keypad..... | 108 |
| Keyless Entry Keypad – Troubleshooting..... | 109 |
| Keyless Entry Keypad Limitations..... | 108 |
| Keyless Entry Keypad Master Access Code..... | 108 |
| Keyless Entry Keypad Personal Access Codes..... | 108 |
| Keyless Entry Keypad – Troubleshooting..... | 109 |
| Keyless Entry Keypad – Frequently Asked Questions..... | 109 |
| Keyless Entry Limitations..... | 106 |
| Keyless Entry Settings..... | 106 |
| Keyless Entry – Troubleshooting..... | 107 |
| Keyless Entry – Frequently Asked Questions..... | 107 |
| Keys and Remote Controls..... | 87 |
| Keys and Remote Controls – Troubleshooting..... | 95 |
| Keys and Remote Controls – Troubleshooting..... | 95 |
| Keys and Remote Controls – Information Messages..... | 95 |
| L | |
| Lane Centering..... | 338 |
| How Does Lane Centering Work..... | 338 |
| Lane Centering Alerts..... | 339 |
| Lane Centering Automatic Cancellation..... | 339 |
| Lane Centering Indicators..... | 340 |
| Lane Centering Limitations..... | 339 |
| Lane Centering Precautions..... | 338 |
| Lane Centering Requirements..... | 338 |
| Switching Lane Centering On and Off..... | 339 |
| Lane Keeping System Indicators..... | 364 |
| Lane Keeping System..... | 361 |
| Aid Mode..... | 363 |
| Alert and Aid Mode..... | 363 |
| Alert Mode..... | 362 |
| Lane Keeping System – Troubleshooting..... | 365 |
| Lane Keeping System Limitations..... | 361 |
| Lane Keeping System Precautions..... | 361 |
| Lane Keeping System – Troubleshooting..... | 365 |
| Lane Keeping System – Frequently Asked Questions..... | 366 |
| Lane Keeping System – Information Messages..... | 365 |
| Launching or Retrieving a Boat or Personal Watercraft..... | 405 |
| Linking or Unlinking a Personal Profile to a Remote Control..... | 629 |
| Live Traffic..... | 630 |
| Switching Live Traffic On and Off..... | 630 |
| What Is Live Traffic..... | 630 |
| Load Carrying..... | 388 |
| Load Carrying Precautions..... | 388 |
| Loading Your Trailer..... | 404 |
| Locating the 360 Degree Cameras..... | 321 |
| Locating the 360 Degree Cameras – Raptor/Tremor..... | 322 |
| Locating the Auxiliary Switches..... | 636 |
| Locating the Auxiliary Switch Wiring..... | 637 |
| Locating the Blind Spot Information System Sensors..... | 369 |
| Locating the Brake Fluid Reservoir..... | 286 |
| Locating the Cross Traffic Alert Sensors..... | 373 |
| Locating the Fuel Filler Funnel..... | 250 |
| Locating the Keyless Entry Keypad..... | 108 |
| Locating the Memory Function Buttons..... | 204 |
| Locating the Power Outlets..... | 213 |
| Locating the Pre-Collision Assist Sensors..... | 378 |
| Locating the Pre-Collision Assist Sensors – Police Responder..... | 378 |
| Locating the Rear View Camera..... | 318 |
| Locating the Safety Compliance Certification Labels..... | 389 |
| Locating the Tire label..... | 519 |
| Locating the USB Ports..... | 209 |

Index

| | |
|---|-----|
| Locating the USB Ports - Raptor..... | 209 |
| Locating the Wireless Accessory Charger..... | 226 |
| Locating Your Vehicle..... | 89 |
| Locking and Unlocking the Tailgate..... | 111 |
| Locking the Rear Window Controls..... | 160 |

M

| | |
|--|-----|
| Maintenance..... | 482 |
| Engine Air Filter..... | 493 |
| Engine Oil..... | 488 |
| Exterior Bulbs..... | 499 |
| Interior Bulbs..... | 508 |
| Maintenance Precautions..... | 482 |
| Making and Receiving a Phone Call..... | 622 |
| Manually Dimming the Interior Mirror..... | 161 |
| Manually Releasing the Electric Parking Brake..... | 289 |
| Manually Shifting Gears..... | 262 |
| Shifting Using the Buttons on the Selector Lever..... | 263 |
| Shifting Using the Paddle Shifters..... | 262 |
| Manual Park Release..... | 267 |
| Manual Park Release Precautions..... | 267 |
| Using Manual Park Release..... | 267 |
| What Is Manual Park Release..... | 267 |
| Manual Seats..... | 191 |
| Adjusting the Head Restraint..... | 191 |
| Adjusting the Lumbar Support..... | 192 |
| Adjusting the Seat Backrest..... | 192 |
| Folding the Seats..... | 199 |
| Head Restraint Components..... | 191 |
| Installing the Head Restraint..... | 192 |
| Moving the Seat Backward and Forward..... | 192 |
| Removing the Head Restraint..... | 192 |
| Unfolding the Seats..... | 200 |
| Massage Seats..... | 196 |
| Adjusting the Massage Seat Settings..... | 196 |
| Massage Seat Limitations..... | 196 |
| Memory Function..... | 204 |
| Memory Function Precautions..... | 204 |
| Mislock..... | 103 |
| Mislock Limitations..... | 103 |

| | |
|--|-----|
| Switching Mislock On and Off..... | 103 |
| What Is Mislock..... | 103 |
| Mobile Communications Equipment..... | 688 |
| Mobile Device Data..... | 30 |
| Moonroof Bounce-Back..... | 165 |
| Overriding Moonroof Bounce-Back..... | 165 |
| What Is Moonroof Bounce-Back..... | 165 |
| Moonroof..... | 164 |
| Moonroof Bounce-Back..... | 165 |
| Motorcraft Parts - 2.7L EcoBoost™..... | 563 |
| Motorcraft Parts - 3.3L..... | 564 |
| Motorcraft Parts - 3.5L, Hybrid Electric Vehicle (HEV)..... | 566 |
| Motorcraft Parts - 3.5L EcoBoost™..... | 565 |
| Motorcraft Parts - 5.0L..... | 567 |
| Motorcraft Parts - Raptor..... | 568 |
| Muting the Audio..... | 604 |
| MyKey Settings..... | 96 |
| Configurable MyKey Settings..... | 96 |
| Non-Configurable MyKey Settings..... | 96 |
| MyKey – Troubleshooting..... | 99 |
| MyKey – Frequently Asked Questions..... | 101 |
| MyKey – Information Messages..... | 99 |
| MyKey™..... | 96 |
| MyKey Settings..... | 96 |
| MyKey – Troubleshooting..... | 99 |

N

| | |
|-----------------------------------|-----|
| Navigation Map Updates..... | 630 |
| Navigation..... | 630 |
| Adjusting the Map..... | 630 |
| Live Traffic..... | 630 |
| Route Guidance..... | 631 |
| Setting a Destination..... | 630 |
| Waypoints..... | 631 |
| Normal Scheduled Maintenance..... | 645 |

O

| | |
|--|-----|
| Off-Road Driving..... | 449 |
| After Driving Your Vehicle Off-Road..... | 454 |
| Basic Off-Road Driving Techniques..... | 449 |
| Driving Off-Road..... | 450 |
| Driving Through Water Limitations..... | 453 |

Index

| | |
|---|-----|
| Driving Your Vehicle at High Speeds..... | 452 |
| Off-Road Driving Aids..... | 453 |
| Off-Road Driving Precautions..... | 449 |
| Water Wading..... | 453 |
| What Is Off-Road Driving..... | 449 |
| On-Board Scale Limitations..... | 420 |
| On-Board Scale..... | 420 |
| Opening and Closing the Flip Key..... | 88 |
| Opening and Closing the Hood..... | 482 |
| Opening and Closing the Moonroof..... | 164 |
| Opening and Closing the Sliding Windows..... | 160 |
| Opening and Closing the Sun Shade..... | 164 |
| Opening and Closing the Windows..... | 159 |
| Opening the Tailgate..... | 111 |
| Opening the Tailgate From Inside Your Vehicle..... | 117 |
| Opening the Tailgate From Outside Your Vehicle..... | 111 |
| Opening the Tailgate Using the Remote Control..... | 117 |
| Operating the Doors From Inside Your Vehicle..... | 102 |
| Individually Unlocking and Locking the Doors Using the Locking Button..... | 102 |
| Opening the Doors From Inside Your Vehicle..... | 103 |
| Operating the Doors From Outside Your Vehicle..... | 102 |
| Unlocking and Locking the Doors Using the Key Blade..... | 102 |
| Unlocking and Locking the Doors Using the Remote Control..... | 102 |
| Operating Your Vehicle With a Snowplow..... | 459 |
| Ordering a Canadian French Owner's Manual..... | 657 |
| Overriding Reverse Braking Assist..... | 293 |
| Overriding the Set Speed..... | 337 |
| P | |
| Parking Aid Indicators..... | 317 |
| Parking Aid Precautions..... | 313 |
| Parking Aids..... | 313 |
| Front Parking Aid..... | 314 |
| Parking Aids – Troubleshooting..... | 317 |
| Rear Parking Aid..... | 314 |
| Side Parking Aid..... | 315 |
| Parking Aids – Troubleshooting..... | 317 |
| Parking Aids – Information Messages..... | 317 |
| Passive Anti-Theft System..... | 132 |
| How Does the Passive Anti-Theft System Work..... | 132 |
| What Is the Passive Anti-Theft System..... | 132 |
| Pedestrian Alert System..... | 84 |
| Perchlorate..... | 687 |
| Performing a Master Reset..... | 634 |
| Personalized Settings..... | 176 |
| Changing the Measurement Unit..... | 176 |
| Changing the Temperature Unit..... | 176 |
| Changing the Tire Pressure Unit..... | 176 |
| Personal Profiles..... | 628 |
| Personal Safety System Components..... | 69 |
| Personal Safety System™..... | 69 |
| Phone Menu..... | 620 |
| Phone..... | 620 |
| Phone Precautions..... | 620 |
| Pickup Bed Anchor Points..... | 394 |
| Installing and Removing the Pickup Bed Tie-Down Cleats..... | 394 |
| Pickup Bed Anchor Point Precautions..... | 394 |
| Pickup Bed..... | 394 |
| Pickup Bed Anchor Points..... | 394 |
| Pickup Bed Ramps..... | 396 |
| Tailgate Anchor Points..... | 395 |
| Pickup Bed Precautions..... | 394 |
| Pickup Bed Ramps..... | 396 |
| Installing and Removing the Pickup Bed Ramp Holder..... | 396 |
| Installing and Removing the Pickup Bed Ramps..... | 397 |
| Pickup Bed Ramp Precautions..... | 396 |
| Storing the Pickup Bed Ramps..... | 398 |
| Playing Media Using Bluetooth®..... | 625 |
| Playing Media Using the USB Port..... | 209 |
| Playing or Pausing the Audio Source..... | 603 |
| Post-Crash Alert System..... | 466 |
| How Does the Post-Crash Alert System Work..... | 466 |

Index

| | |
|--|-----|
| Post-Crash Alert System | |
| Limitations..... | 466 |
| Switching the Post-Crash Alert System | |
| Off..... | 466 |
| What Is the Post-Crash Alert System..... | 466 |
| Power Outlet Indicators..... | 221 |
| Power Outlet Indicators - Vehicles With: 2.4kW/7.2kW..... | 214 |
| Power Outlet Indicators - Vehicles With: 2kW..... | 213 |
| Power Outlet Limitations..... | 220 |
| Power Outlet..... | 211 |
| Power Outlet – Troubleshooting..... | 217 |
| Power Outlet Precautions..... | 220 |
| Power Outlet Precautions - Vehicles With: 2.4kW/7.2kW..... | 212 |
| With: 2kW..... | 211 |
| Power Outlet – Troubleshooting..... | 217 |
| Power Outlet – Frequently Asked Questions..... | 219 |
| Power Outlet – Information Messages..... | 217 |
| Power Running Board Kick Switch..... | 136 |
| Power Running Board Precautions..... | 136 |
| Power Running Board Settings..... | 136 |
| Power Running Boards..... | 136 |
| Power Running Boards – Troubleshooting..... | 137 |
| Power Running Boards – Troubleshooting..... | 137 |
| Power Running Boards – Frequently Asked Questions..... | 137 |
| Power Seats..... | 193 |
| Adjusting the Head Restraint..... | 193 |
| Adjusting the Lumbar Support..... | 196 |
| Adjusting the Seat Backrest..... | 194 |
| Adjusting the Seat Cushion..... | 194 |
| Adjusting the Seat Height..... | 195 |
| Head Restraint Components..... | 193 |
| Installing the Head Restraint..... | 194 |
| Moving the Seat Backward and Forward..... | 194 |
| Removing the Head Restraint..... | 194 |
| Pre-Collision Assist Limitations..... | 376 |
| Pre-Collision Assist Precautions..... | 375 |
| Pre-Collision Assist..... | 375 |
| Automatic Emergency Braking..... | 381 |
| Distance Alert..... | 380 |
| Distance Indication..... | 379 |
| Evasive Steering Assist..... | 381 |
| Pre-Collision Assist – Troubleshooting..... | 382 |
| Pre-Collision Assist – Troubleshooting..... | 382 |
| Pre-Collision Assist – Frequently Asked Questions..... | 384 |
| Pre-Collision Assist – Information Messages..... | 382 |
| Pre-Collision Assist – Warning Lamps..... | 382 |
| Preparing Your Vehicle for Storage..... | 517 |
| Programming a MyKey..... | 98 |
| Programming the Garage Door Opener to Your Garage Door Opener Motor..... | 206 |
| Programming the Garage Door Opener to Your Gate Opener Motor..... | 207 |
| Programming the Garage Door Opener to Your Hand-Held Transmitter..... | 206 |
| Programming the Remote Control – Vehicles With: Flip Key..... | 94 |
| Programming the Remote Control – Vehicles With: Push Button Start..... | 93 |
| Properly Adjusting the Driver and Front Passenger Seats..... | 73 |
| Puncture | |
| See: Changing a Flat Tire..... | 543 |
| See: Changing a Flat Tire - Raptor/ Tremor..... | 549 |
| Push Button Ignition Switch..... | 232 |

R

| | |
|---|-----|
| Radio Frequency Certification | |
| Labels..... | 659 |
| Blind Spot Information System Sensors..... | 659 |
| Body Control Module..... | 660 |
| Cruise Control Module..... | 663 |
| Keys and Remote Controls..... | 665 |
| Passive Anti-Theft System..... | 668 |
| Radio Transceiver Module..... | 672 |
| SYNC..... | 675 |

Index

| | | | |
|--|-----|--|-----|
| Tire Pressure Monitoring System Sensors..... | 680 | Recreationally Towing Your Vehicle - 4x2..... | 471 |
| Wireless Accessory Charging Module..... | 684 | Recreationally Towing Your Vehicle - 4x4..... | 469 |
| Rear Axle Fluid Capacity and Specification - Police Responder..... | 594 | Refueling..... | 251 |
| Rear Axle Fluid Capacity and Specification - Raptor..... | 594 | Manually Opening the Fuel Filler Door..... | 255 |
| Rear Axle Fluid Capacity and Specification..... | 593 | Refueling System Overview..... | 251 |
| Rear Exterior - Police Responder..... | 46 | Refueling Your Vehicle..... | 251 |
| Rear Exterior - Raptor..... | 45 | Releasing the Electric Parking Brake if the Vehicle Battery Has Run Out of Charge..... | 290 |
| Rear Exterior..... | 44 | Remote Control Limitations..... | 87 |
| Rear Occupant Alert System Audible Warnings..... | 203 | Remotely Starting and Stopping the Vehicle..... | 178 |
| Rear Occupant Alert System Indicators..... | 203 | Remote Start Limitations..... | 178 |
| Rear Occupant Alert System Limitations..... | 202 | Remote Start Precautions..... | 178 |
| Rear Occupant Alert System Precautions..... | 202 | Remote Start Remote Control Indicators..... | 179 |
| Rear Occupant Alert System..... | 202 | Remote Start..... | 178 |
| Rear Parking Aid..... | 314 | Remote Start Settings..... | 179 |
| Locating the Rear Parking Aid Sensors..... | 314 | Remote Start Settings..... | 179 |
| Rear Parking Aid Audible Warnings..... | 314 | Setting the Remote Start Duration..... | 180 |
| Rear Parking Aid Limitations..... | 314 | Switching Climate Control Auto Mode On and Off..... | 179 |
| What is the Rear Parking Aid..... | 314 | Switching Climate Control Last Settings On and Off..... | 179 |
| Rear Seats..... | 199 | Switching the Heated Seat Settings On and Off..... | 180 |
| Heated Seats..... | 200 | Switching the Heated Steering Wheel Settings On and Off..... | 180 |
| Manual Seats..... | 199 | Removing and Installing the Tailgate..... | 111 |
| Rear View Camera Guide Lines..... | 319 | Removing the Key Blade..... | 89 |
| Rear View Camera Precautions..... | 318 | Removing Your Vehicle From Storage..... | 518 |
| Rear View Camera..... | 318 | Repairing Minor Paint Damage..... | 515 |
| Rear View Camera Settings..... | 319 | Replacement Parts Recommendation..... | 688 |
| Rear View Camera Settings..... | 319 | Replacing a Lost Key or Remote Control..... | 93 |
| Switching Rear View Camera Delay On and Off..... | 320 | Replacing the Cabin Air Filter..... | 189 |
| Switching the Rear View Camera View..... | 320 | Replacing the Front Wiper Blades..... | 142 |
| Zooming the Rear View Camera In and Out..... | 319 | Reporting Safety Defects in Canada..... | 658 |
| Rebooting the Center Display..... | 616 | Reporting Safety Defects in the United States..... | 658 |
| Recalling a Preset Position..... | 204 | | |
| Recovery Towing..... | 467 | | |
| Accessing the Front Towing Point..... | 467 | | |

Index

| | |
|--|-----|
| Reprogramming the Garage Door Opener..... | 208 |
| Resetting Ground Fault Detection..... | 215 |
| Resetting the Circuit Breaker - Vehicles With: 7.2kW..... | 216 |
| Resetting the Stopping Position - Vehicles With: Power Adjustable Steering Column..... | 139 |
| Resetting Tire Pressure Monitoring System..... | 538 |
| Restarting the Engine..... | 244 |
| Resuming the Set Speed..... | 330 |
| Reverse Braking Assist Indicators..... | 293 |
| Reverse Braking Assist Precautions..... | 292 |
| Reverse Braking Assist - Reverse Braking Assist - Troubleshooting..... | 294 |
| Reverse Braking Assist - Troubleshooting..... | 294 |
| Reverse Braking Assist - Frequently Asked Questions..... | 295 |
| Reverse Braking Assist - Information Messages..... | 294 |
| Roadside Assistance..... | 462 |
| Rollover Warning..... | 656 |
| Route Guidance..... | 631 |
| Adjusting the Guidance Prompt Volume..... | 631 |
| Canceling Route Guidance..... | 631 |
| Repeating an Instruction..... | 631 |
| Running-In See: Breaking-In..... | 455 |
| Running Out of Fuel..... | 250 |
| Adding Fuel From a Portable Fuel Container..... | 250 |
| Filling a Portable Fuel Container..... | 250 |
| S | |
| Satellite Radio..... | 607 |
| Locating the Satellite Radio Identification Number..... | 608 |
| Satellite Radio Limitations..... | 607 |
| Satellite Radio Settings..... | 608 |
| Selecting a Channel..... | 608 |
| What Is Satellite Radio..... | 607 |
| Saving a Preset Position..... | 204 |
| Scheduled Maintenance..... | 642 |
| Seatbelt Extensions..... | 68 |
| Seatbelt Precautions..... | 61 |
| Seatbelt Reminder..... | 65 |
| How Does the Seatbelt Reminder Work..... | 65 |
| Seatbelt Reminder Audible Warnings..... | 67 |
| Seatbelt Reminder Indicators..... | 67 |
| Switching the Seatbelt Reminder On and Off..... | 67 |
| Seatbelts..... | 61 |
| Automatic Locking Mode..... | 63 |
| Seatbelt Reminder..... | 65 |
| Sensitive Locking Mode..... | 63 |
| Security..... | 132 |
| Anti-Theft Alarm System..... | 132 |
| Anti-Theft Alarm System Settings..... | 133 |
| Passive Anti-Theft System..... | 132 |
| Security - Troubleshooting..... | 134 |
| Security - Troubleshooting..... | 134 |
| Security - Frequently Asked Questions..... | 135 |
| Security - Information Messages..... | 134 |
| Selecting a Drive Mode - Raptor..... | 351 |
| Selecting a Drive Mode..... | 350 |
| Selecting a Four-Wheel Drive Mode - Raptor..... | 272 |
| Selecting a Four-Wheel Drive Mode..... | 271 |
| Selecting the Audio Source..... | 603 |
| Sending and Receiving a Text Message..... | 623 |
| Sensitive Locking Mode..... | 63 |
| How Does Sensitive Locking Mode Work..... | 63 |
| What is Sensitive Locking Mode..... | 63 |
| Service Data..... | 28 |
| Setting a Destination..... | 630 |
| Setting a Destination Using a Point of Interest..... | 631 |
| Setting a Destination Using a Predictive Destination..... | 631 |
| Setting a Destination Using a Recent Destination..... | 631 |
| Setting a Destination Using a Saved Destination..... | 631 |
| Setting a Destination Using the Map Screen..... | 630 |

Index

| | |
|---|-----|
| Setting a Destination Using the Text Entry Screen..... | 630 |
| Setting a Memory Preset..... | 604 |
| Settings Data..... | 29 |
| Setting the Adaptive Cruise Control Gap..... | 335 |
| Setting the Adaptive Cruise Control Speed..... | 334 |
| Setting the Blower Motor Speed..... | 182 |
| Setting the Clock and Date..... | 605 |
| Setting the Cruise Control Speed..... | 329 |
| Setting the Hill Descent Speed..... | 309 |
| Setting the Temperature..... | 182 |
| Setting the Trail Control Speed - Raptor..... | 303 |
| Setting the Wake Word..... | 617 |
| Setting Up the Trailer Backup Assistance for a Conventional Trailer..... | 422 |
| Applying the Trailer Reversing Aid Sticker..... | 424 |
| Calibrating the System..... | 425 |
| Configuring the Trailer..... | 422 |
| Trailer Sensor Installation..... | 424 |
| Setting Up Trailer Reverse Guidance for a Conventional Trailer..... | 437 |
| Applying the Trailer Reverse Aid Sticker..... | 438 |
| Calibrating the System..... | 440 |
| Configuring the Trailer..... | 437 |
| Trailer Sensor Installation..... | 439 |
| Shifting Your Vehicle Into Gear - Police Responder..... | 262 |
| Shifting Your Vehicle Into Gear - Raptor..... | 261 |
| Shifting Your Vehicle Into Gear..... | 261 |
| Side Parking Aid..... | 315 |
| Locating the Side Parking Aid Sensors..... | 316 |
| Side Parking Aid Audible Warnings..... | 316 |
| Side Parking Aid Limitations..... | 315 |
| What is the Side Parking Aid..... | 315 |
| Sitting in the Correct Position..... | 190 |
| Smart Hitch Limitations..... | 418 |
| Smart Hitch..... | 418 |
| Snow Plowing Precautions..... | 458 |
| Snow Plowing..... | 458 |
| Snowplow Mode..... | 460 |
| Snowplow Mode..... | 460 |
| Switching Snowplow Mode On and Off..... | 460 |
| What Is Snowplow Mode..... | 460 |
| Sounding the Panic Alarm..... | 89 |
| Special Operating Conditions Scheduled Maintenance - Gasoline..... | 648 |
| Special Operating Conditions Scheduled Maintenance - Raptor..... | 651 |
| Speed Control See: Cruise Control..... | 329 |
| Speedometer..... | 168 |
| Stability Control Indicator..... | 302 |
| Stability Control..... | 300 |
| Starter Switch See: Ignition Switch..... | 231 |
| Starting and Stopping the Engine - Precautions..... | 231 |
| Starting and Stopping the Engine..... | 231 |
| Automatic Engine Stop - Vehicles With: Keyless Entry and Push Button Start..... | 236 |
| Engine Block Heater..... | 234 |
| Starting and Stopping the Engine - Troubleshooting..... | 238 |
| Starting the Engine..... | 232 |
| Stopping the Engine..... | 235 |
| Starting and Stopping the Engine - Troubleshooting..... | 238 |
| Starting and Stopping the Engine - Frequently Asked Questions..... | 239 |
| Starting and Stopping the Engine - Information Messages..... | 238 |
| Starting and Stopping the Engine - Warning Lamps..... | 238 |
| Starting the Engine..... | 232 |
| Restarting the Engine After Stopping it..... | 234 |
| Starting a Gasoline Engine..... | 232 |
| Starting a Hybrid Electric Vehicle System..... | 233 |
| Status Bar..... | 614 |
| Steering..... | 311 |
| Electric Power Steering..... | 311 |
| Steering - Troubleshooting..... | 312 |
| Steering - Troubleshooting..... | 312 |
| Steering - Information Messages..... | 312 |
| Steering - Warning Indicators..... | 312 |

Index

| | |
|---|-----|
| Steering Wheel - Police Responder..... | 34 |
| Steering Wheel - Raptor..... | 33 |
| Steering Wheel..... | 32 |
| Stopping the Engine..... | 244 |
| Stopping the Engine When Your Vehicle is Moving..... | 236 |
| Stopping the Engine When Your Vehicle is Stationary..... | 235 |
| Storage..... | 227 |
| Cup Holders..... | 227 |
| Glasses Holder..... | 230 |
| Glove Compartment..... | 227 |
| Under Seat Storage..... | 228 |
| Storing Your Vehicle..... | 517 |
| Stowing the Selector Lever - Raptor..... | 266 |
| Stowing the Selector Lever..... | 266 |
| Sunroof See: Moonroof..... | 164 |
| SVT..... | 19 |
| Switching Active Park Assist On and Off..... | 325 |
| Switching Adaptive Cruise Control On and Off..... | 333 |
| Switching Air Conditioning On and Off..... | 181 |
| Switching All of the Interior Lamps On and Off..... | 157 |
| Switching Android Auto On and Off..... | 627 |
| Switching Apple CarPlay On and Off..... | 627 |
| Switching Auto Hold On and Off..... | 297 |
| Switching Auto-Start-Stop On and Off..... | 244 |
| Switching Blind Spot Information System On and Off..... | 368 |
| Switching BlueCruise On and Off..... | 346 |
| Switching Climate Control On and Off..... | 181 |
| Switching Cross Traffic Alert On and Off..... | 373 |
| Switching Cruise Control On and Off..... | 329 |
| Switching Defrost On and Off..... | 181 |
| Switching Driver Alert On and Off..... | 386 |
| Switching Easy Entry and Exit On and Off..... | 110 |
| Switching From Adaptive Cruise Control to Cruise Control..... | 337 |
| Switching Generator Mode On and Off..... | 215 |
| Switching Hill Descent Control On and Off..... | 309 |
| Switching Maximum Cooling On and Off..... | 182 |
| Switching Maximum Defrost On and Off..... | 181 |
| Switching Parking Aid On and Off..... | 313 |
| Switching Pre-Collision Assist On and Off - Police Responder..... | 377 |
| Switching Pre-Collision Assist On and Off..... | 377 |
| Switching Rear Occupant Alert System On and Off..... | 202 |
| Switching Recirculated Air On and Off..... | 181 |
| Switching Repeat Mode On and Off..... | 604 |
| Switching Reverse Braking Assist On and Off..... | 293 |
| Switching Shuffle Mode On and Off..... | 604 |
| Switching Stability Control On and Off..... | 301 |
| Switching Text Message Notification On and Off..... | 624 |
| Switching the Audio Unit On and Off..... | 603 |
| Switching the Display On and Off..... | 606 |
| Switching the Electronic Locking Differential On and Off - 4x2..... | 283 |
| Switching the Electronic Locking Differential On and Off - 4x4..... | 280 |
| Switching the Electronic Locking Differential On and Off - Raptor..... | 281 |
| Switching the Front Interior Lamps On and Off - Police Responder..... | 157 |
| Switching the Front Interior Lamps On and Off..... | 157 |
| Switching the Hazard Flashers On and Off..... | 464 |
| Switching the Heated Mirrors On and Off..... | 182 |
| Switching the Heated Rear Window On and Off..... | 182 |

Index

| | |
|--|-----|
| Switching the Heated Steering Wheel On and Off - Vehicles With: Heated Steering Wheel..... | 139 |
| Switching the Heated Wiper Park On and Off..... | 182 |
| Switching the Lane Keeping System Mode..... | 362 |
| Switching the Lane Keeping System On and Off..... | 362 |
| Switching the Rear Interior Lamps On and Off..... | 158 |
| Switching Traction Control On and Off..... | 298 |
| Switching Trail Control On and Off - Raptor..... | 303 |
| Switching Trailer Backup Assistance On and Off..... | 426 |
| Switching Trailer Hitching Assistance On and Off..... | 416 |
| Switching Trailer Reverse Guidance On and Off..... | 440 |
| Switching Trailer Sway Control On and Off..... | 414 |
| Switching Trail Turn Assist On and Off..... | 307 |
| Switching Utility Idle On and Off - Vehicles With: Flip Key..... | 214 |
| Symbols Glossary..... | 24 |
| Symbols Used on Your Vehicle..... | 24 |
| T | |
| Tachometer..... | 168 |
| Tailgate Anchor Points..... | 395 |
| Locating the Tailgate Anchor Points..... | 395 |
| Tailgate Anchor Point Load Capacities..... | 395 |
| Tailgate Precautions..... | 111 |
| Tailgate Step..... | 112 |
| Accessing the Tailgate Step..... | 112 |
| Stowing the Tailgate Step..... | 113 |
| Tailgate..... | 111 |
| Bed Extender..... | 113 |
| Closing the Tailgate..... | 117 |
| Opening the Tailgate..... | 111 |
| Tailgate Step..... | 112 |
| Tailgate – Troubleshooting..... | 123 |
| Tailgate – Troubleshooting..... | 123 |
| Tailgate – Frequently Asked Questions..... | 124 |
| Tailgate – Information Messages..... | 123 |
| Tailgate – Warning Lamps..... | 123 |
| Tailgate Work Surface..... | 115 |
| Team RS..... | 19 |
| Technical Specifications | |
| See: Capacities and Specifications..... | 558 |
| Temporary Neutral Mode..... | 264 |
| Entering Temporary Neutral Mode..... | 264 |
| Exiting Temporary Neutral Mode..... | 265 |
| Temporary Neutral Mode Limitations..... | 264 |
| What Is Temporary Neutral Mode..... | 264 |
| The Better Business Bureau Auto Line Program..... | 656 |
| The Mediation and Arbitration Program..... | 657 |
| Tire Care..... | 532 |
| Tire Pressure Monitoring System Limitations..... | 537 |
| Tire Pressure Monitoring System Overview..... | 536 |
| Tire Pressure Monitoring System Precautions..... | 537 |
| Tire Pressure Monitoring System..... | 536 |
| Tire Pressure Monitoring System – Troubleshooting..... | 541 |
| Tire Pressure Monitoring System – Troubleshooting..... | 541 |
| Tire Pressure Monitoring System – Information Messages..... | 542 |
| Tire Pressure Monitoring System – Warning Lamps..... | 541 |
| Tire Replacement Requirements..... | 526 |
| Tire Rotation..... | 534 |
| Towing a Trailer Limitations..... | 404 |
| Towing a Trailer Precautions..... | 403 |
| Towing a Trailer..... | 403 |
| Towing a Trailer – Troubleshooting..... | 408 |
| Towing Weights and Dimensions..... | 406 |
| Towing a Trailer – Troubleshooting..... | 408 |
| Towing a Trailer – Information Messages..... | 408 |

Index

| | | | |
|--|-----|---|-----|
| Towing Weights and Dimensions..... | 406 | Trailer Hitching Assistance | |
| Calculating the Maximum Loaded Trailer | | Indicators..... | 417 |
| Weight for Your Vehicle..... | 407 | Trailer Hitching Assistance | |
| Recommended Towing Weights..... | 406 | Limitations..... | 415 |
| What Is the Maximum Loaded Trailer | | Trailer Hitching Assistance | |
| Weight..... | 407 | Precautions..... | 415 |
| Towing Your Vehicle Precautions..... | 469 | Trailer Hitching Assistance..... | 415 |
| Towing Your Vehicle..... | 469 | Trailer Lighting Check..... | 401 |
| Towing Your Vehicle – | | Trailer Reverse Guidance | |
| Troubleshooting..... | 471 | Precautions..... | 437 |
| Towing Your Vehicle – | | Trailer Reverse Guidance..... | 437 |
| Troubleshooting..... | 471 | Setting Up Trailer Reverse Guidance for a | |
| Towing Your Vehicle – Information | | Conventional Trailer..... | 437 |
| Messages..... | 471 | Trailer Reverse Guidance – | |
| Traction Control Indicator..... | 298 | Troubleshooting..... | 443 |
| Traction Control..... | 298 | Trailer Reverse Guidance – | |
| Traction Control – Troubleshooting..... | 299 | Troubleshooting..... | 443 |
| Tractor Control – | | Trailer Reverse Guidance – Frequently | |
| Troubleshooting..... | 299 | Asked Questions..... | 445 |
| Traction Control – Information | | Trailer Reverse Guidance – Information | |
| Messages..... | 299 | Messages..... | 443 |
| Trail Control Indicators - Raptor..... | 304 | Trailer Sway Control Precautions..... | 414 |
| Trail Control Limitations - Raptor..... | 303 | Trailer Sway Control..... | 414 |
| Trail Control..... | 303 | Trailer Towing Hints..... | 404 |
| Trail Control – Troubleshooting - | | Trailer Towing Navigation..... | 632 |
| Raptor..... | 306 | Trail One Pedal Drive..... | 304 |
| Trail One Pedal Drive..... | 304 | Switching Trail One Pedal Drive On and | |
| Trail One Pedal Drive – | | Off..... | 304 |
| Troubleshooting..... | 305 | Trail One Pedal Drive Indicators..... | 305 |
| Trail Control – Troubleshooting - | | Trail One Pedal Drive Limitations..... | 304 |
| Raptor..... | 306 | Trail One Pedal Drive Precautions..... | 304 |
| Trail Control – Information | | What Is Trail One Pedal Drive..... | 304 |
| Messages..... | 306 | Trail One Pedal Drive – | |
| Trailer Backup Assistance | | Troubleshooting..... | 305 |
| Precautions..... | 422 | Trail One Pedal Drive – Information | |
| Trailer Backup Assistance..... | 422 | Messages..... | 305 |
| Setting Up the Trailer Backup Assistance | | Trail Turn Assist Indicators..... | 307 |
| for a Conventional Trailer..... | 422 | Trail Turn Assist Limitations..... | 307 |
| Trailer Backup Assistance – | | Trail Turn Assist Precautions..... | 307 |
| Troubleshooting..... | 430 | Trail Turn Assist..... | 307 |
| Trailer Backup Assistance – | | Trail Turn Assist – Troubleshooting..... | 308 |
| Troubleshooting..... | 430 | Trailer Turn Assist – | |
| Trailer Backup Assistance – Frequently | | Troubleshooting..... | 308 |
| Asked Questions..... | 433 | Trail Turn Assist – Frequently Asked | |
| Trailer Backup Assistance – Information | | Questions..... | 308 |
| Messages..... | 430 | Trail Turn Assist – Information | |
| Trailer Brake Precautions..... | 403 | Messages..... | 308 |

Index

| | |
|---|-----|
| Transfer Case Fluid Capacity and Specification - Raptor..... | 591 |
| Transfer Case Fluid Capacity and Specification..... | 591 |
| Transmission Fluid Temperature Gauge..... | 169 |
| Transporting the Vehicle..... | 468 |
| Trip Computer - Vehicles With: 4.2 Inch Screen..... | 175 |
| Accessing the Trip Computer..... | 175 |
| Resetting the Trip Computer..... | 175 |
| Trip Computer - Vehicles With: 8 Inch Screen/12.3 Inch Screen..... | 175 |
| Accessing the Trip Computer..... | 175 |
| Resetting the Trip Computer..... | 175 |
| Turbo Boost Gauge..... | 169 |
| U | |
| Under Hood Fuse Box..... | 472 |
| Accessing the Under Hood Fuse Box..... | 472 |
| Identifying the Fuses in the Under Hood Fuse Box..... | 473 |
| Locating the Under Hood Fuse Box..... | 472 |
| Under Hood Overview - 2.7L EcoBoost™..... | 483 |
| Under Hood Overview - 3.3L..... | 484 |
| Under Hood Overview - 3.5L, Hybrid Electric Vehicle (HEV)..... | 486 |
| Under Hood Overview - 3.5L EcoBoost™..... | 485 |
| Under Hood Overview - 5.0L..... | 487 |
| Under Seat Storage..... | 228 |
| Locating the Under Seat Storage Compartment..... | 228 |
| Unique Features..... | 31 |
| Updating the Vehicle Systems Wirelessly..... | 633 |
| USB Ports..... | 209 |
| Using a Slide-In Camper..... | 389 |
| Using Auto Hold..... | 297 |
| Using Bead-Lock Wheels - Raptor..... | 530 |
| Using Keyless Entry..... | 106 |
| Using MyKey With Remote Start Systems..... | 98 |
| Using On-Board Scale..... | 420 |
| Using Progressive Range Selection..... | 265 |
| Using Smart Hitch..... | 418 |
| Using Snow Chains..... | 528 |
| Using the Center Console Work Surface - Vehicles With: Column Shift..... | 223 |
| Using the Center Console Work Surface - Vehicles With: Console Shift..... | 224 |
| Using the Instrument Cluster Display Controls..... | 173 |
| Using the Integrated Trailer Brake Controller..... | 410 |
| Using the Keyless Entry Keypad..... | 109 |
| Using the Remote Control - Police Responder..... | 87 |
| Using the Remote Control..... | 88 |
| Using the Trailer Backup Assistance Controller..... | 427 |
| Using the Trailer Backup Assistance Views..... | 427 |
| Using This Publication..... | 23 |
| Using Trailer Hitching Assistance..... | 416 |
| Using Trailer Reverse Guidance Views..... | 441 |
| V | |
| Vehicle Care..... | 511 |
| Cleaning the Exterior..... | 511 |
| Cleaning the Interior..... | 513 |
| Vehicle Identification Number..... | 596 |
| Locating the Vehicle Identification Number..... | 596 |
| Vehicle Identification Number Overview..... | 596 |
| Vehicle Identification..... | 596 |
| Vehicle Identification Number..... | 596 |
| Vehicle Interior - Police Responder..... | 40 |
| Vehicle Interior - Raptor..... | 39 |
| Vehicle Interior..... | 38 |
| Vehicle System Updates..... | 633 |
| Vehicle Wi-Fi Hotspot..... | 601 |
| Ventilated Seats..... | 197 |
| Switching the Ventilated Seats On and Off..... | 197 |
| Ventilated Seat Precautions..... | 197 |

Index

| | |
|--|-----|
| Ventilation | |
| See: Climate Control - Vehicles With: | |
| Automatic Temperature Control..... | 181 |
| See: Climate Control - Vehicles With: Manual Temperature Control..... | 186 |
| Venting the Moonroof..... | 164 |
| Viewing the Tire Pressures..... | 538 |
| Visual Search..... | 32 |
| Voice Interaction Examples..... | 617 |
| Voice Interaction..... | 617 |
| W | |
| Warranty Terms and Conditions..... | 639 |
| Washer Fluid Specification..... | 589 |
| Washers..... | 143 |
| Adding Washer Fluid..... | 143 |
| Switching the Courtesy Wipe On and Off..... | 143 |
| Using the Windshield Washer..... | 143 |
| Washer Fluid Specification..... | 143 |
| Washer Precautions..... | 143 |
| Washers | |
| See: Wipers and Washers..... | 141 |
| Waxing Your Vehicle..... | 516 |
| Waypoints..... | 631 |
| Adding a Waypoint..... | 631 |
| Editing Waypoints..... | 631 |
| What Are the Auxiliary Switches..... | 636 |
| What Are the Instrument Cluster Indicators..... | 171 |
| What Are the Instrument Cluster Warning Lamps..... | 169 |
| What Is 911 Assist..... | 85 |
| What Is a Connected Vehicle..... | 597 |
| What Is Active Park Assist..... | 325 |
| What Is a Hybrid Electric Vehicle..... | 241 |
| What Is Auto-Start-Stop..... | 244 |
| What Is Blind Spot Information System..... | 368 |
| What Is BlueCruise..... | 344 |
| What Is Brake Coach..... | 176 |
| What Is Cross Traffic Alert..... | 372 |
| What Is Cruise Control..... | 329 |
| What Is Drive Mode Control..... | 350 |
| What Is Driver Alert..... | 386 |
| What Is Ford Protect..... | 640 |
| What Is Generator Mode..... | 215 |
| What Is Hill Descent Control..... | 309 |
| What Is Hill Start Assist..... | 296 |
| What Is MyKey..... | 96 |
| What Is On-Board Scale..... | 420 |
| What Is Pre-Collision Assist..... | 375 |
| What Is Remote Start..... | 178 |
| What Is the Reverse Braking Assist..... | 292 |
| What Is Smart Hitch..... | 418 |
| What Is the 360 Degree Camera..... | 321 |
| What Is the Cabin Air Filter..... | 189 |
| What Is the Catalytic Converter..... | 258 |
| What Is the Electric Parking Brake..... | 289 |
| What Is the Electronic Locking Differential..... | 279 |
| What Is the Garage Door Opener..... | 205 |
| What Is the Gross Axle Weight Rating..... | 389 |
| What Is the Gross Combined Weight Rating..... | 390 |
| What Is the Gross Vehicle Weight Rating..... | 389 |
| What Is the High Voltage Battery..... | 259 |
| What Is the Integrated Trailer Brake Controller..... | 410 |
| What Is the Keyless Entry Keypad..... | 108 |
| What Is the Lane Keeping System..... | 361 |
| What Is the Memory Function..... | 204 |
| What Is the Pedestrian Alert System..... | 84 |
| What Is the Personal Safety System..... | 69 |
| What Is the Power Outlet..... | 211 |
| What Is the Rear Occupant Alert System..... | 202 |
| What Is the Rear View Camera..... | 318 |
| What Is the Tire Pressure Monitoring System..... | 536 |
| What Is the Trip Summary..... | 177 |
| What Is the Wireless Accessory Charger..... | 226 |
| What Is Traction Control..... | 298 |
| What Is Trail Control - Raptor..... | 303 |
| What Is Trailer Backup Assistance..... | 422 |
| What Is Trailer Hitching Assistance..... | 415 |
| What Is Trailer Reverse Guidance..... | 437 |
| What Is Trail Turn Assist..... | 307 |

Index

| | |
|--|-----|
| What Is Utility Idle Mode - Vehicles With: | |
| Flip Key..... | 214 |
| What is Voice Interaction..... | 617 |
| Wheel and Tire Information..... | 519 |
| Wheel Nuts..... | 556 |
| Wi Fi | |
| See: Changing the Vehicle Wi-Fi Hotspot | |
| Name or Password..... | 601 |
| See: Connecting the Vehicle to a Wi-Fi | |
| Network..... | 597 |
| See: Creating a Vehicle Wi-Fi Hotspot..... | 601 |
| See: Vehicle Wi-Fi Hotspot..... | 601 |
| Window Bounce-Back..... | 159 |
| Overriding Window Bounce-Back..... | 159 |
| What Is Window Bounce-Back..... | 159 |
| Windows..... | 159 |
| Window Bounce-Back..... | 159 |
| Wipers and Washers – | |
| Troubleshooting..... | 143 |
| Wipers and Washers – Frequently Asked | |
| Questions..... | 144 |
| Wipers and Washers – Warning | |
| Lamps..... | 143 |
| Wipers and Washers..... | 141 |
| Autowipers..... | 141 |
| Washers..... | 143 |
| Wipers..... | 141 |
| Wipers and Washers – | |
| Troubleshooting..... | 143 |
| Wipers..... | 141 |
| Switching Windshield Wipers On and | |
| Off..... | 141 |
| Wiper Precautions..... | 141 |
| Wireless Accessory Charger | |
| Precautions..... | 226 |
| Wireless Accessory Charger..... | 226 |

